

Think Automation and beyond...



12.1  
inch

10.4  
inch

8.4  
inch

5.7  
inch

# HG4G/3G/2G

## Operator Interface

Bright and true-to-life color displays



HG4G (12.1 inch, dark gray)

HG3G (10.4 inch, dark gray, vertical)

HG3G (8.4 inch, light gray)

HG2G (5.7 inch, light gray)

IDEC CORPORATION



HG4G  
12.1 inch

Vertical  
OK



# Connect & Communicate

## “Human Machine Interface (HMI) Solutions”

IEC principle for human-machine interfaces: Fast, easy, and simple.

The sharp and vivid display with high luminance (12.1-inch: 550 cd/m<sup>2</sup>) connects to PLCs, micro computer boards, temperature controllers and cameras, ensuring excellent connectivity and communication in a wide range of industries.

Our new range of operator interfaces provide the optimum environment for your application.



# Designed to perform

## LED

Backlight

True-to-life color. Brightest in its class.



A bright LED backlight provides a vivid display in well-lit surroundings. The brightness of the backlight can be adjusted. Long 60,000-hour service life.

<b>HG4G</b> (12.1 inch) <b>550</b> cd/m <sup>2</sup>	<b>HG3G</b> (10.4 inch) <b>700</b> cd/m <sup>2</sup> (8.4 inch) <b>600</b> cd/m <sup>2</sup>	<b>HG2G</b> (5.7 inch) <b>800</b> cd/m <sup>2</sup> <small>*HG2G-5F</small>
--	--	--

### 48-level Brightness Adjustment LED backlight dimming control

The brightness of the backlight can be adjusted according to surrounding conditions (day/night).



### Graphics More than 7,000 graphic images

1,000 graphic images have been added. Realistic images of switches, pilot lights, and other parts allow you to easily create your own custom screens.



### Application Example

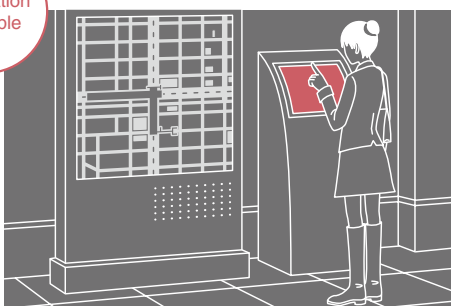



# Control

## Simple I/O Control      Simple control

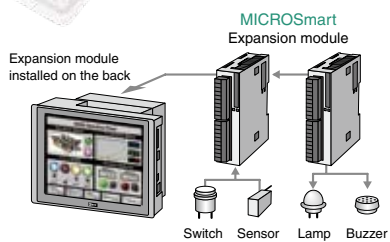
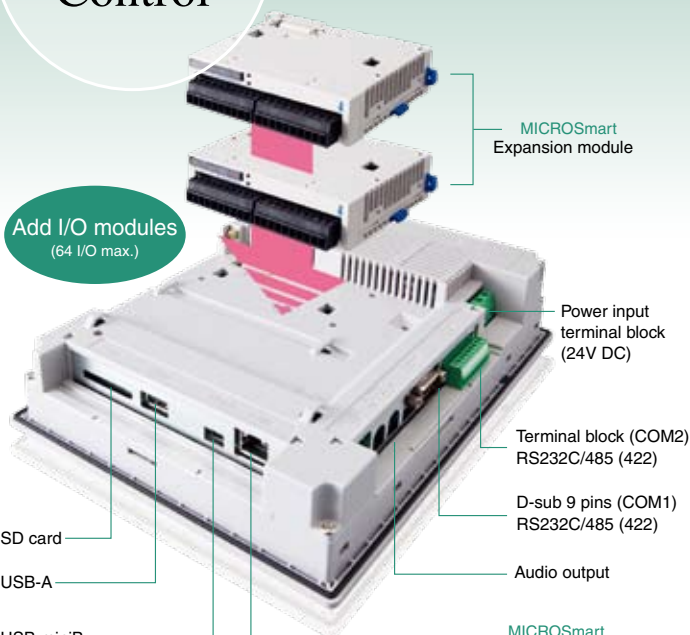

### Audio Output      Sound file (30 sec max.)

Audio error messages can be sent to an operator, providing faster system recovery. Audio output can also be used as a voice guidance system.

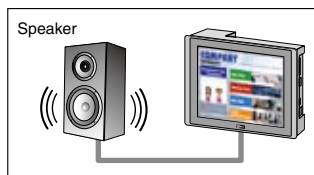

### Ethernet      Remote data maintenance

Project data can be downloaded and uploaded remotely via Ethernet. One HG can communicate with two or more PLCs, enabling integration of a network (PC) and a control network (PLC) systems.

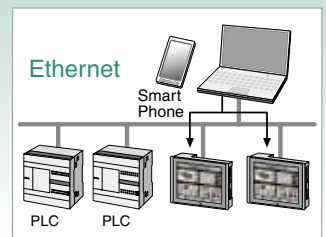

### O/I Link      IDEC high-speed 115.2 kbps O/I Link communication

A maximum of 16 HGs can be connected to a PLC using RS485 (2-wire), easily creating a high-speed network reducing cost.

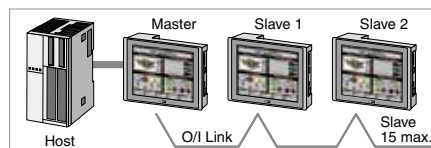

### I/O Module      Display and I/O control in one package

A maximum of four MicroSmart expansion modules can be connected, allowing equipment control using a small number of I/O points. (Input, output, I/O modules can be used.)

\*HG4G/3G can connect up to 4, HG2G can connect up to 2 expansion modules.  
\*For compatible expansion modules, see "Expansion Modules" on page 25.

### Cyclic Script      Cyclic I/O control

Cyclic script enables parallel processing of I/O control. Real time I/O processing for high performance.

Conventional model	Display	I/O	Display	I/O	Display	I/O	
HG Series	I/O	Display	I/O	Display	I/O	Display	I/O
	10 to 1000 ms		10 to 1000 ms		10 to 1000 ms		



# Fast & Easy

Instant Response

3-sec startup



High Speed CPU

Fast start-up

High-speed 400 MHz CPU and unique software technology shorten startup time. Fast start-up allows for easy debugging.

High Speed Data

Fast USB2.0 communication

Project data can be downloaded and uploaded easily using a USB flash drive.

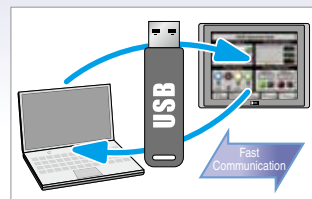

Easy Maintenance

Simple operation



SD Card

Convenient SD card slot

Data can be saved or transferred by using an SD card (32 GB max.). By saving user data on an SD card, user memory can be reduced.

USB Flash Drive

USB flash drive enables easy data transfer.

Inserting a USB flash drive into the HG will automatically bring up the USB transfer menu. Operator can work on errors without the use of a PC.

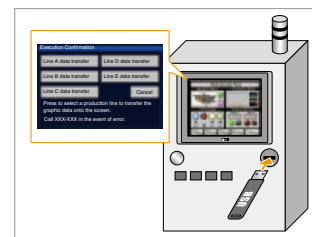

Front Panel Maintenance

Easy data maintenance, without opening the control cabinet.

Using a USB panel-mount cable, data can be transferred without opening the panel. The pass-through function enables debugging of ladder programs in the PLC, connected to the HG, inside the cabinet. \* See "Compatible PLCs" on the back page.

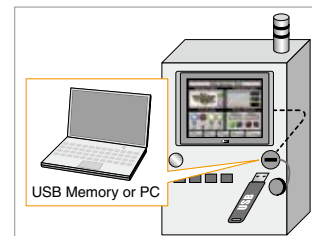

Application Example

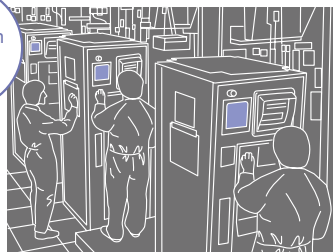

Pict Bridge

USB printer compatible

HG screen information and alarm history can be printed out from Pict Bridge compatible printers.

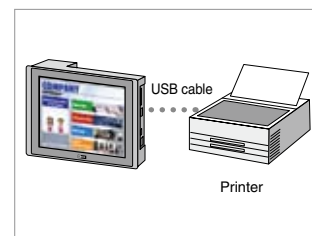



Operates on 64-bit Windows 7, providing easy programming with fewer clicks required, enabling efficiency. The workspace is flexible and easy to use.

### Dynamic and flexible screen designs

The ribbon organizes commands in groups and tabs, making it possible to find commands easily and quickly.

### Graphic library with extensive collection of images

7000 graphic images can be selected from the library tool. Graphics that are used frequently as part images can be quickly selected from the parts list.

### Easy-to-view work space

Project structure can be listed for easy viewing, and switched to the editing screen in one click.

### Design screens using the object list

Device, operating conditions, and type of command can be read from the object list. During debugging, data stored in the device is shown in popups, and perating conditions can be distinguished via color.

### Easy programming

Operating conditions for buttons and lamps can be programmed in the property settings.

### Create language screens easily

Switch to any of the supported languages by using the text manager within the same project. Translation is easy as Unicode format files can be imported/exported.

### Tag editor shows available devices at a glance

Device addresses used in the project can be easily identified by using the tag editor and cross-references.



No.	Name	Type	Device	Trigger Type	Trigger Condition
48	Bitmap	Bitmap			
49	NumInput1	Numeric	LBR 002	3 Always ON	
50	MultiCommand1	Multi-Co.	LBR 000	0 Ringed...	[LSM 01]
51	MultiCommand2	Multi-Co.	LBR 010	6 While sat...	100 > [LBR 01]
52	NumInput1	Numeric	LDR 1000	3 Always ON	
53	ScreenButton	Goto Scr...	100	3 Always ON	
54	PrintButton1	Print Butt...	LDR 1000 = 0	3 Always ON	
55	ScreenButton1	Goto Scr...	1	3 Always ON	
56	ScreenSwitch3	Goto Scr...	LSD 051	0 Ringed...	[LSM 01]
57	ScreenCommand1	Word W...		3 Always ON	
58	ScreenSwitch3	Goto Scr...	1	3 Always ON	
59	ScreenSwitch3	Goto Scr...	2	3 Always ON	
60	ScriptCommand1	Script Co.	5	7 Fixed Per...	1

Address	Tag Name	Comment
M0000	Start	Main Pos...
M0001	Stop	Main Pos...
M0002	Switch3	Input0...
M0003	Switch	Input0...
M0004	Switch	Input0...

Text ID	Text Group	Text	Message
1	STOP	STOP	
2	START	START	
3	MENU	MENU	
4	RUN	RUN	

## System Requirements

- Windows 7 (32-bit/64-bit), Windows Vista (32-bit), Windows XP (32-bit, Service Pack 3 or later) (Ensure that your operating system has the latest update from the Microsoft Windows Update website)
- 512 MB RAM (1 GB recommended)
- 800 MB hard disk space
- 1.0 GHz or faster CPU
- Microsoft .NET Framework 3.5
- Screen resolution of 1024 x 768 or more
- Mouse, CD-ROM drive, administrator account

\*Windows is a registered trademark of Microsoft Corporation, USA and other countries.  
\*Wind OI-NV2 is included in IDEC's package software "Automation Organizer".



# Multimedia

## Multimedia Functions

### Records and plays back high quality images

Multimedia models with video and audio input terminals. The screen records images on an SD card through a connected video camera and images recorded on an SD card can be played back on the screen or PC.

\* HG4G-CJT22MF, HG3G-AJT22MF, HG3G-8JTMF models only.

Displays images on the screen from the camera.

Records and plays back images on the screen from the camera and saves the data on the SD card.

\*available soon (Note)

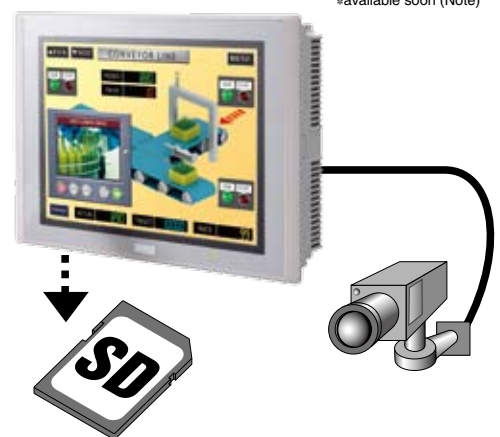
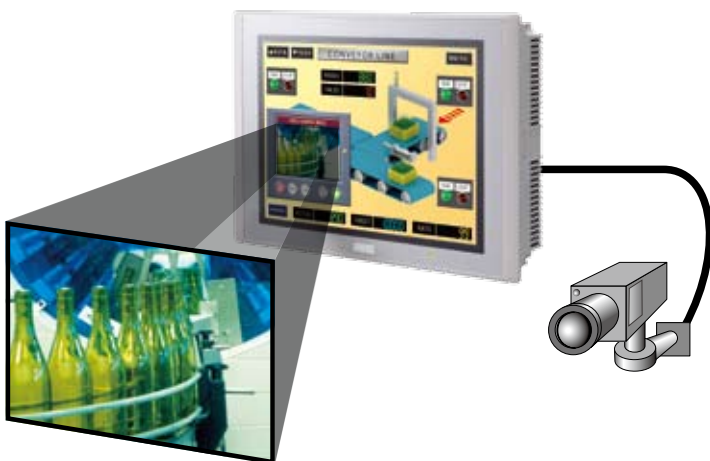

#### Video Play Replays video images and audio from an SD card.

MPEG4 video files can be played back on the screen. Work procedures can be shown on the screen, and when trouble occurs, it can be used as a video manual for troubleshooting on-site.



#### Video Recording Records video images of an error

When an alarm is set off, video images before and after the start of the alarm can be recorded on an SD card. This enables on-site analysis of the trouble. Smooth and refined images can be recorded.

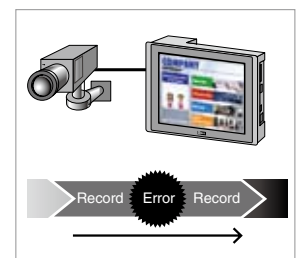

Note: Programming software with video recording function will be available via free upgrade. For the latest information, visit our website at [www.idec.com](http://www.idec.com)





## Application Examples

### 1 Find out the cause of an error

\*available soon (Note)

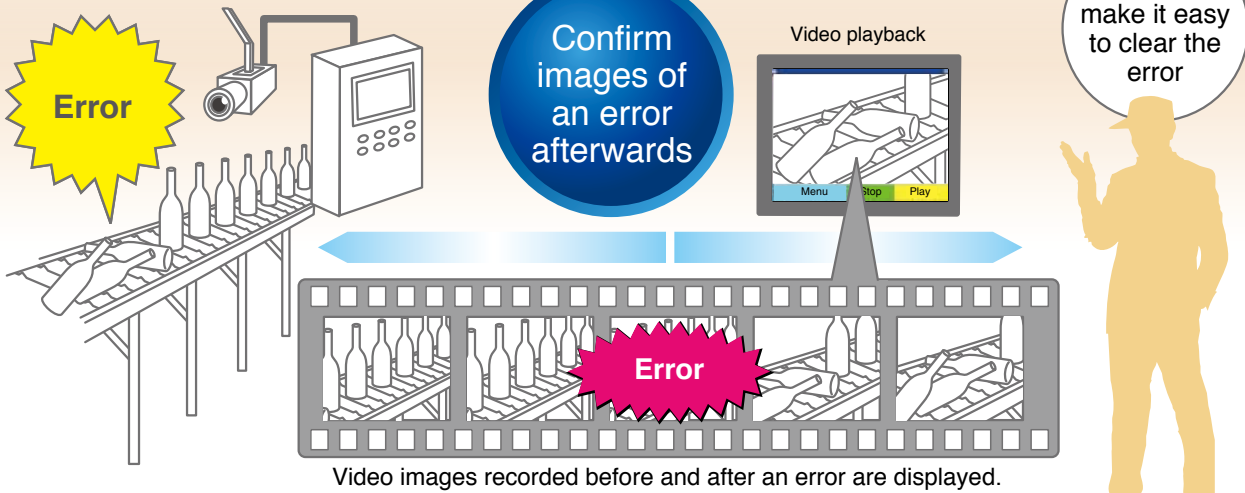

### 2 On-site troubleshooting

Video manuals are useful for troubleshooting

Error

Error is displayed

Video manual is displayed on the screen

(110706)

### 3 Ideal for displaying promotional messages

Clear display and sound

Speaker

# Human-machine interface expands IDEC

Easy troubleshooting using video images

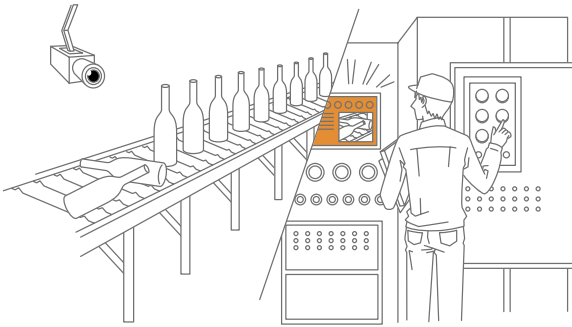

Complicated maintenance can be carried out



## Lineup

## HG series Operator Interface

### High Performance

**HG4G**

12.1 inch

**New**

314 × 240 × 54.1 mm  
SVGA (800 × 600)  
TFT65,536 colors

Bright 550 cd/m <sup>2</sup>	LED 60,000 Hours	48-level Brightness Adjustment	Graphics
Stroke Fonts	Serial Interface	Ethernet	USB mini-B
USB A	4 Expansion Modules	Audio Output	O/I Link
Cyclic Script	SD Card	USB Flash Drive	High Speed CPU
High Speed Data	User Memory 12MB	Pict Bridge	Front Panel Maintenance
Audio Input	Video Input	Video Play	Video Recording
Voltage 24V DC	Vertical OK	Bezel Color	Dark gray

**HG3G**

10.4 inch      8.4 inch

**New**      **New**

Bright 700 cd/m<sup>2</sup>      Bright 600 cd/m<sup>2</sup>

270 × 212 × 52.7 mm      231 × 176 × 54.4 mm  
SVGA (800 × 600)      SVGA (800 × 600)  
TFT65,536 colors      TFT65,536 colors

LED 60,000 Hours	48-level Brightness Adjustment	Graphics	Stroke Fonts	Serial Interface
Ethernet	USB mini-B	USB A	4 Expansion Modules	Audio Output
O/I Link	Cyclic Script	SD Card	USB Flash Drive	High Speed CPU
High Speed Data	User Memory 12MB	Pict Bridge	Front Panel Maintenance	Audio Input
Video Input	Video Play	Video Recording	Voltage 24V DC	Vertical OK
Bezel Color	Light gray	Dark gray		

\* New multimedia functions

**HG2G-5F**

5.7 inch

**New**

167.2 × 134.7 × 54.4 mm  
VGA (640 × 480)  
TFT65,536 colors

Bright 800 cd/m <sup>2</sup>	LED 50,000 Hours	48-level Brightness Adjustment	Graphics	
Stroke Fonts	Serial Interface	Ethernet	USB mini-B	
USB A	2 Expansion Modules	O/I Link	Cyclic Script	
SD Card	USB Flash Drive	High Speed CPU	High Speed Data	
User Memory 12MB	Pict Bridge	Front Panel Maintenance	Voltage 24V DC	
Vertical OK	Bezel Color	Light gray	Dark gray	Silver

# network control

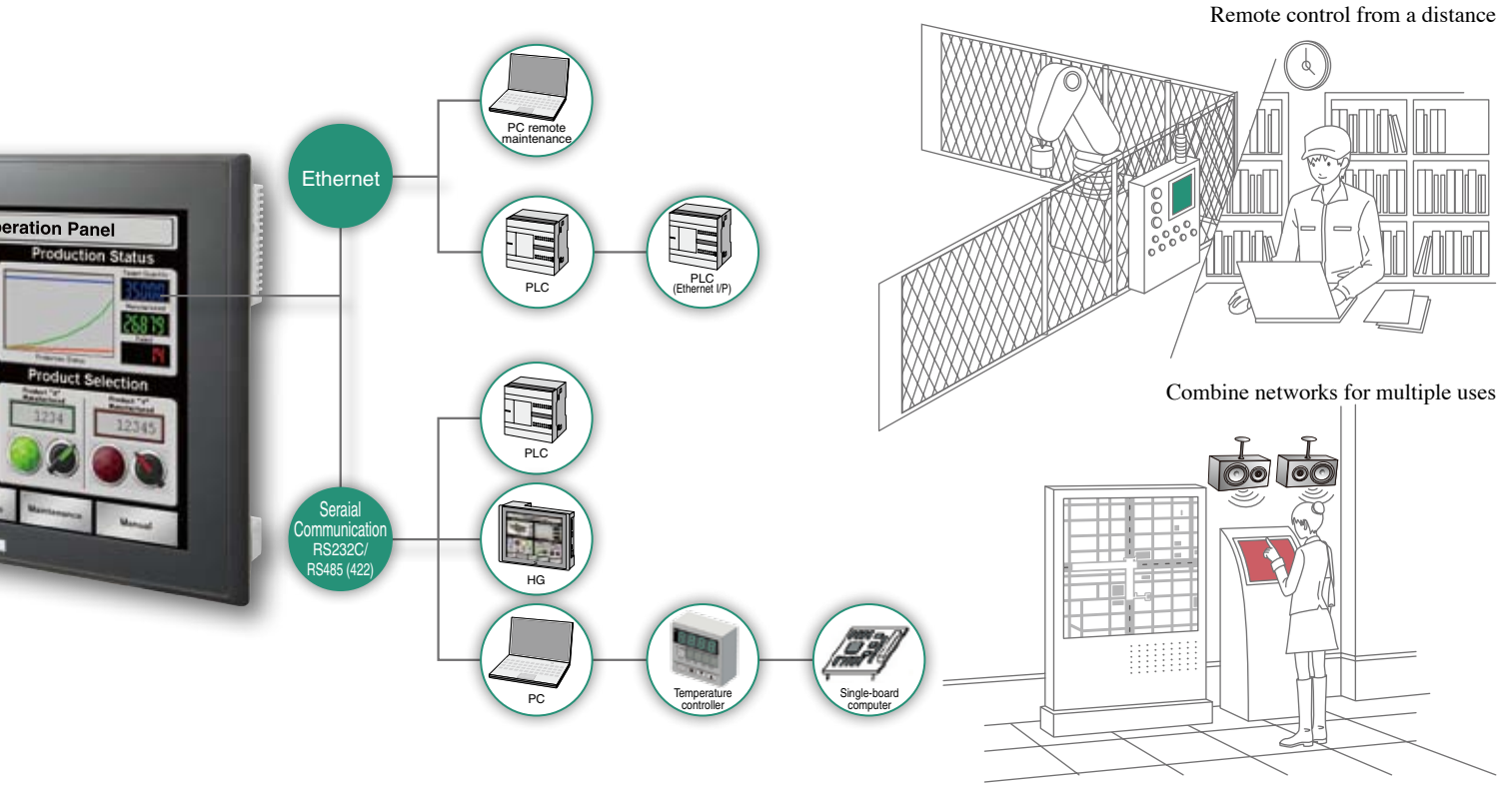

## Basic

### HG2G-5S

5.7 inch

**New**

167.2 × 134.7 × 40.9 mm  
QVGA (320 × 240)  
TFT256 colors

- Bright 400 cd/m<sup>2</sup>
- LED 50,000 Hours
- 32-level Brightness Adjustment
- Serial Interface
- Ethernet
- USB mini-B
- O/I Link
- User Memory 2MB
- Voltage 12/24V DC

Bezel Color: Light gray, Dark gray, Silver

### HG2G-S

5.7 inch

167.2 × 134.7 × 40.9 mm  
QVGA (320 × 240)  
STN Monochrome (15 shades)

- Bright 500 cd/m<sup>2</sup>
- CCFL 75,000 Hours
- Serial Interface
- Ethernet
- O/I Link
- User Memory 2MB
- Voltage 12 V DC
- Voltage 24 V DC

Bezel Color: Light gray, Dark gray, Silver

## Compact

### HG1F

4.6 inch

147 × 76 × 39.3 mm  
(300 × 1000)  
STN Monochrome (16 shades)

- Bright 500 cd/m<sup>2</sup>
- Serial Interface
- User Memory 1MB
- Voltage 24V DC

Bezel Color: Light gray, Dark gray, Silver

\* See catalog no. EP1128 for details.

Sharp & Vivid

- Bright
- LED
- Brightness Adjustment
- Graphics
- Stroke Fonts

>> Page 4

Simple Control

- Serial Interface
- Ethernet
- USB mini-B
- USB A
- Expansion Module
- Audio Output
- O/I Link
- Cyclic Script

>> Page 5

Fast & Easy

- SD Card
- USB Flash Drive
- High Speed CPU
- High Speed Data
- User Memory
- Pict Bridge
- Front Panel Maintenance

>> Page 6

Multimedia

- Audio Input
- Video Input
- Video Play
- Video Recording

>> Page 8

12.1  
inch

# HG4G Operator Interface



Compact housing with a versatile interface.  
High performance operator interface with multimedia functions.

- Bright 550 cd/m<sup>2</sup>
  - TFT 65,536 Colors
  - LED 60,000 Hours
  - SVGA 800×600
  - 48-level Brightness Adjustment
  - Graphics
  - Stroke Fonts
  - Serial Interface
  - Ethernet
  - USB mini-B
  - USB A
  - 4 Expansion Modules
  - Audio Output
  - O/I Link
  - Cyclic Script
  - SD Card
  - USB Flash Drive
  - High Speed CPU
  - High Speed Data
  - User Memory 12MB
  - Pict Bridge
  - Front Panel Maintenance
  - Audio Input
  - Video Input
  - Video Play
  - Video Recording
  - Voltage 24V DC
  - Vertical OK
- Bezel Color  \* Video recording function available soon (Note)  
Dark gray



No.	Name
①	Power LED
②	Display
③	Touchscreen
④	Power Supply Terminal
⑤	Serial Interface (COM2)
⑥	Serial Interface (COM1)
⑦	Audio Interface (AUDIO OUT)
⑧	Ethernet Interface (LAN)
⑨	USB Interface (USB1)

No.	Name
⑩	USB Interface (USB2)
⑪	Memory Card Interface (SD)
⑫	SD Memory Access LED
⑬	Expansion Module Interface (EXT)
⑭	Battery Cover
⑮	Terminal Resistor Switch
⑯	Audio Interface (AUDIO IN)
⑰	Video Interface (VIDEO IN)

  (Approval for HG4G operator interface only, excluding options or expansion modules.)

Note: Programming software with video recording function will be available via free upgrade.  
For the latest information, visit our website at [www.idec.com](http://www.idec.com)

## HG4G Operator Interface

Display Screen	Operation Style	Communication/Memory Interface	Video/Audio Interface	Housing/Bezel Color	Part No. (Ordering No.)	Approvals
12.1-inch TFT color LCD 65,536 colors	Touch Switch (analog resistive)	COM1 COM2 LAN USB1 USB2 SD Memory Card	VIDEO IN AUDIO IN AUDIO OUT	Dark gray	<b>HG4G-CJT22MF-B</b>	Safety Standards: UL508 CSA C22.2 No.142
			AUDIO OUT	Dark gray	<b>HG4G-CJT22TF-B</b>	Ship Classification Standards: ABS, LR, NK

\*DNV approval pending

## Dimensions

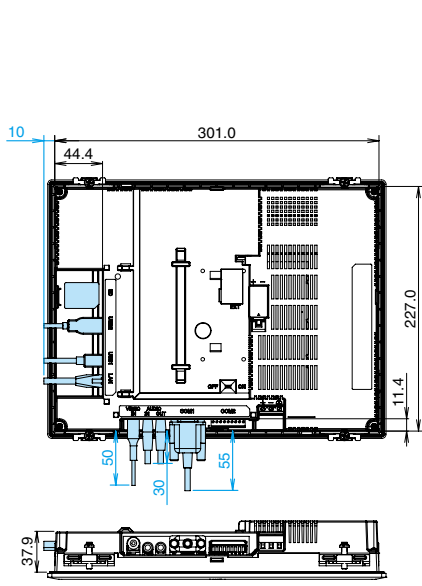
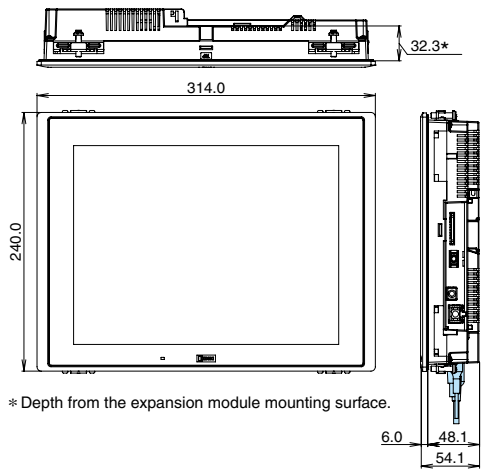

## Panel Cut-out

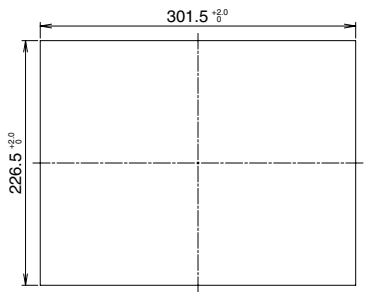

All dimensions in mm.

Note 1: Dimensions in blue show the mounting dimensions of the cable.  
Note 2: Dimensions in the figure may vary depending on the type of cable connected.  
Note 3: Install the HG4G into a panel cut-out by tightening the four mounting clips (supplied with the HG4G) to a torque of 0.5 to 0.6 N·m.  
Do not tighten with excessive force, otherwise the HG4G and screen may become distorted. Also waterproof characteristics may be lost.

## General Specifications

Rated Power Voltage	24V DC
Power Voltage Range	20.4 to 28.8V DC
Power Consumption	27W maximum 18W maximum when not using USB interface (USB2) or expansion module interface (EXT)
Allowable Momentary Power Interruption	10 ms maximum
Inrush Current	30A maximum
Dielectric Strength	1,000V AC, 10 mA, 1 minute between power and FG terminals
Insulation Resistance	10 MΩ minimum between power and FG terminals (500V DC megger)
Operating Temperature	0 to +50°C (no freezing)
Operating Humidity	10 to 90% RH (no condensation)
Storage Temperature	-20 to +60°C (no freezing)
Storage Humidity	10 to 90% RH (no condensation)
Pollution Degree	2
Vibration Resistance	5 to 8.4 Hz amplitude 3.5 mm, 8.4 to 150 Hz, acceleration 9.8 m/s <sup>2</sup> 10 cycles (100 minutes) on each of three mutually perpendicular axes
Shock Resistance	147 m/s <sup>2</sup> , 11 ms 5 shocks on each of three mutually perpendicular axes
Noise Immunity	Fast transient/burst test, Power terminals: ±2 kV, Communication line: ±1 kV (IEC/EN61131-2: 2007)
Electrostatic Discharge	ESD-3 (RH-1) Level 3 (Contact ±6 kV, air ±8 kV) (IEC/EN61131-2: 2007)
Corrosion Immunity	Free from corrosive gases
Mounting	Panel mounting
Degree of Protection	IP66 (IEC 60529) (front part when mounted) *
Dimensions	314.0W × 240.0H × 54.1D mm
Weight (approx.)	2.1 kg

- Do not use the HG4G in an environment subject to strong ultraviolet rays, otherwise the LCD quality will deteriorate.
- \* Protection degree of the front surface after mounting. Operation not guaranteed under certain environments.

## Display Specifications

Display	TFT Color LCD	
Color/Shade	65,536 colors	
Effective Display Area	246.0W × 184.5H mm	
Display Resolution	800W × 600H pixels	
View Angle	Right and left 80°, up 80°, down 60°	
Backlight	LED	
Backlight Life	60,000 hours minimum *1	
Brightness	550 cd/m <sup>2</sup> *2	
Brightness Adjustment	48 levels	
Backlight Replacement	Not possible	
Display Character Size	1/4 size	8 × 8 pixels (Western European language: ISO 8859-1, Central European language: ANSI 1250, Baltic: ANSI 1257, Cyrillic: ANSI1251, Japanese katakana and symbols: JIS 8-bit code)
	1/2 size	8 × 16 pixels (Western European language ISO 8859-1, Central European language: ANSI 1250, Baltic: ANSI 1257, Cyrillic: ANSI1251, Japanese katakana and symbols: JIS 8-bit code)
	Full size	16 × 32 pixels, 24 × 48 pixels, 32 × 64 pixels (Western European language: ISO 8859-1)
	Double size	16 × 16 pixels (Japanese JIS first and second level characters, simplified Chinese, traditional Chinese, Korean)
	Scalable	32 × 32 pixels (Japanese JIS first level characters, Mincho font)
	Scalable	Width 8 to 128 dots (1/2 size fixed) (ISO 8859-1 western language, 7-segment)
Quantity of Characters	1/4 size	100 characters × 75 lines
	1/2 size	100 characters × 37 lines
	Full size	50 characters × 37 lines
	Double size	25 characters × 18 lines (Mincho font)
Character Magnification	0.5, 1, 2, 3, 4, and 8 vertically and horizontally (except for scalable fonts)	
Character Attribute	Blink (1 or 0.5 sec period), reverse, bold, shadowed	
Graphics	Straight line, polyline, rectangle, circle, ellipse, arc, pie, equilateral polygons (3, 4, 5, 6, 8), paint, bitmap image	
Window Display	3 popup screens + 1 system screen	

\*1 The backlight life refers to the time until the brightness reduces by half after use at 25°C.

\*2 Brightness of the LCD only.

## Operation Specifications

Switching Element	Analog resistive membrane
Operating Force	3N maximum
Mechanical Life	1,000,000 operations
Acknowledgement Sound	Electronic buzzer or speaker output

## Function Specifications

Screen Types	Base screen, popup screen, system screen
No. of Screens	Base screen: 3,000 max. Popup screen: 3,015 max.
User Memory	12 MB (including expansion fonts)
Parts	Bit Button, Word Button, Goto Screen, Print Button, Key Button, Multi Button, Keypad, Selector Switch, Potentiometer, Numerical Input, Character Input, Pilot Lamp, Multi-State Lamp, Picture Display, Message Display, Message Switching Display, Alarm List Display, Alarm Log Display, Numerical Display, Bar Graph, Trend Chart, Pie Chart, Meter, Calendar, Bit Write Command, Word Write Command, Goto Screen Command, Print Command, Timer, Screen Script Command, Multi Command, Video Display
Calendar	Year, Month, Day, Hour, Min., Sec., Day of Week ±60 sec per month (at 25°C)
Power Failure Backup Data	Calendar, log data, keep internal relay, keep internal register
Battery	Recommended replacement span: every 4 years (at 25°C)

## Interface Specifications

Serial Interface (COM1)	Electrical Characteristics	EIA RS232C/485 (422) compliant
	Transmission Speed	1200, 2400, 4800, 9600, 19200, 38400, 57600, 115200, 187500 bps (Note)
	Synchronization	Asynchronous
	Communication Method	Half or full duplex
Serial Interface (COM2)	Control System	Hardware control or none
	Connector	D-sub 9-pin connector
	Electrical Characteristics	EIA RS232C/485 (422) compliant
	Transmission Speed	1200, 2400, 4800, 9600, 19200, 38400, 57600, 115200, 187500 bps (Note)
Serial Interface (COM2)	Synchronization	Asynchronous
	Communication Method	Half or full duplex
	Control System	Hardware control or none
	Connector	Detachable 9-pin terminal block
Ethernet Interface (LAN)	Interface	IEEE802.3 (10/100BASE-T) compliant
	Connector	Modular connector (RJ-45)
Video Interface (VIDEO IN)	Interface	NTSC/PAL
	Connector	Pin jack
Audio Interface (AUDIO IN)	Interface	LINE IN (stereo)
	Connector	Mini jack connector (ø3.5 mm)
Audio Interface (AUDIO OUT)	Interface	LINE OUT (stereo)
	Connector	Mini jack connector (ø3.5 mm)
USB Interface (USB2)	Interface	USB 2.0 high speed (480 Mbps)
	Connector	USB Type A connector
USB Interface (USB1)	Interface	USB 2.0 high speed (480 Mbps)
	Connector	USB Type Mini-B connector
Memory Card Interface (SD)	Interface	SD memory card, SDHC memory card
	Connector	SD memory card socket
Expansion Module Interface (EXT)	Interface	MicroSmart I/O module interface
	Output current	5V 130 mA 24V 150 mA
	Max. no. of units	4 units

Note: 187,500 bps is available only with SIEMENS SIMATIC S7-300/400 series (MPI port direct connection).

10.4  
inch

# HG3G Operator Interface

Excellent visibility by super-bright LED backlight.  
700 cd/m<sup>2</sup> (10.4-inch)

Bright 700 cd/m <sup>2</sup>	TFT 65,536 Colors	LED 60,000 Hours	SVGA 800-600
48-level Brightness Adjustment	Graphics	Stroke Fonts	Serial Interface
Ethernet	USB mini-B	USB A	4 Expansion Modules
Audio Output	O/I Link	Cyclic Script	SD Card
USB Flash Drive	High Speed CPU	High Speed Data	User Memory 12MB
Pict Bridge	Front Panel Maintenance	Audio Input	Video Input
Video Play	Video Recording	Voltage 24V DC	Vertical OK

Bezel Color:  Light Gray  Dark Gray

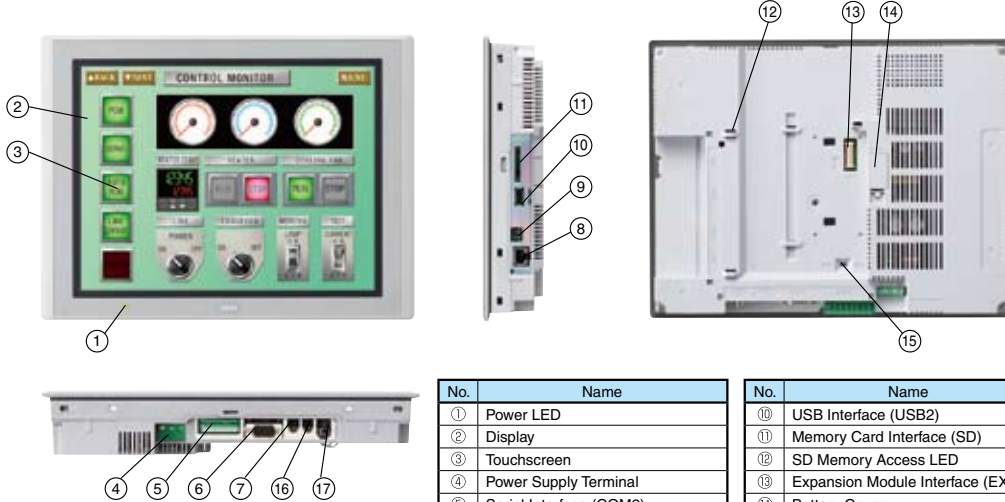

No.	Name
①	Power LED
②	Display
③	Touchscreen
④	Power Supply Terminal
⑤	Serial Interface (COM2)
⑥	Serial Interface (COM1)
⑦	Audio Interface (AUDIO OUT)
⑧	Ethernet Interface (LAN)
⑨	USB Interface (USB1)

No.	Name
⑩	USB Interface (USB2)
⑪	Memory Card Interface (SD)
⑫	SD Memory Access LED
⑬	Expansion Module Interface (EXT)
⑭	Battery Cover
⑮	Terminal Resistor Switch
⑯	Audio Interface (AUDIO IN)
⑰	Video Interface (VIDEO IN)

\* Video recording function available soon (Note)

(Approval for HG3G operator interface only, excluding options or expansion modules.)

Note: Programming software with video recording function will be available via free upgrade.  
For the latest information, visit our website at [www.idec.com](http://www.idec.com)

## HG3G Operator Interface

Display Screen	Operation Style	Communication/Memory Interface	Video/Audio Interface	Housing/Bezel Color	Part No. (Ordering No.)	Approvals
10.4-inch TFT color LCD 65,536 colors	Touch Switch (analog resistive)	COM1 COM2 LAN USB1 USB2 SD Memory Card	VIDEO IN AUDIO IN AUDIO OUT	Light gray	<b>HG3G-AJT22MF-W</b>	Safety Standards: UL508 CSA C22.2 No.142 CSA C22.2 No.213 ANSI/ISA-12.12.01-2007  Ship Classification Standards: ABS, LR, NK
				Dark gray	<b>HG3G-AJT22MF-B</b>	
			AUDIO OUT	Light gray	<b>HG3G-AJT22TF-W</b>	
			Dark gray	<b>HG3G-AJT22TF-B</b>		

\*DNV approval pending

## Dimensions

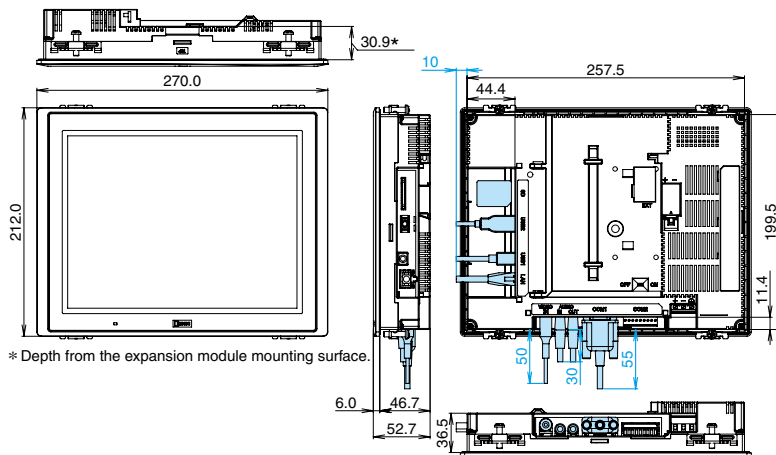

\* Depth from the expansion module mounting surface.

## Panel Cut-out

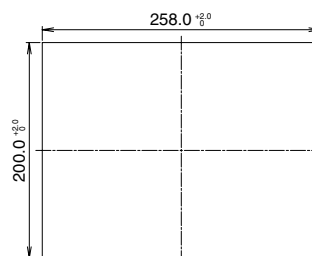

All dimensions in mm.

Note 1: Dimensions in blue show the mounting dimensions of the cable.

Note 2: Dimensions in the figure vary depending on the type of cable connected.

Note 3: Install the HG3G into a panel cut-out by tightening the four mounting clips (supplied) to a torque of 0.5 to 0.6 N-m.

Do not tighten with excessive force, otherwise the HG3G and screen may be distorted. Also waterproof characteristics may be lost.

## General Specifications

Model	HG3G-A (10.4 inch)
Rated Power Voltage	24V DC
Power Voltage Range	20.4 to 28.8V DC
Power Consumption	25W maximum 15W maximum when not using USB interface (USB2) or expansion module interface (EXT)
Allowable Momentary Power Interruption	10 ms maximum
Inrush Current	30A maximum
Dielectric Strength	1,000V AC, 10 mA, 1 minute between power and FG terminals
Insulation Resistance	10 MΩ minimum between power and FG terminals (500V DC megger)
Operating Temperature	0 to +50°C (no freezing)
Operating Humidity	10 to 90% RH (no condensation)
Storage Temperature	-20 to +60°C (no freezing)
Storage Humidity	10 to 90% RH (no condensation)
Pollution Degree	2
Vibration Resistance	5 to 8.4 Hz amplitude 3.5 mm, 8.4 to 150 Hz, acceleration 9.8 m/s <sup>2</sup> 10 cycles (100 minutes) on each of three mutually perpendicular axes
Shock Resistance	147 m/s <sup>2</sup> , 11 ms 5 shocks on each of three mutually perpendicular axes
Noise Immunity	Fast transient/burst test, Power terminals: ±2 kV, Communication line: ±1 kV (IEC 61131-2: 2007)
Electrostatic Discharge	Contact ±6 kV, air ±8 kV (IEC 61131-2: 2007)
Corrosion Immunity	Free from corrosive gases
Mounting	Panel mounting
Degree of Protection	IP66 (IEC 60529) (front part when mounted) * TYPE 4X
Dimensions	270.0W × 212.0H × 52.7D mm
Weight (approx.)	1.65 kg

- Do not use the HG3G in an environment subject to strong ultraviolet rays, otherwise the LCD quality will deteriorate.
- \* Protection degree of the front surface after mounting. Operation not guaranteed under certain environments.

## Display Specifications

Model	HG3G-A (10.4 inch)	
Display Color	TFT Color LCD	
Color/Shade	65,536 colors	
Effective Display Area	211.2 W × 158.4 H mm	
Display Resolution	800 W × 600 H pixels	
View Angle	Right and left 80°, up 80°, down 60°	
Backlight	LED	
Backlight Life	60,000 hours minimum *1	
Brightness	700 cd/m <sup>2</sup> *2	
Brightness Adjustment	48 levels	
Backlight Replacement	Not possible	
Display Character Size	1/4 size	8 × 8 pixels (Western European language: ISO 8859-1, Central European language: ANSI 1250, Baltic: ANSI 1257, Cyrillic: ANSI1251, Japanese katakana and symbols: JIS 8-bit code)
	1/2 size	8 × 16 pixels (Western European language ISO 8859-1, Central European language: ANSI 1250, Baltic: ANSI 1257, Cyrillic: ANSI1251, Japanese katakana and symbols: JIS 8-bit code)
	Full size	16 × 32 pixels, 24 × 48 pixels, 32 × 64 pixels (Western European language: ISO 8859-1)
	Double size	16 × 16 pixels (Japanese JIS first and second level characters, simplified Chinese, traditional Chinese, Korean)
	Scalable	32 × 32 pixels (Japanese JIS first level characters, Mincho font)
Quantity of Characters	1/4 size	Width 8 to 128 dots (1/2 size fixed) (ISO 8859-1 western language, 7-segment)
	1/2 size	100 characters × 75 lines
	Full size	100 characters × 37 lines
	Double size	50 characters × 37 lines
Character Magnification	1/4 size	25 characters × 18 lines (Mincho font)
	1/2 size	100 characters × 75 lines
	Full size	100 characters × 37 lines
	Double size	50 characters × 37 lines
Character Attribute	Blink (1 or 0.5 sec period), reverse, bold, shadowed	
Graphics	Straight line, polyline, rectangle, circle, ellipse, arc, pie, equilateral polygons (3, 4, 5, 6, 8), paint, bitmap image	
Window Display	3 popup screens + 1 system screen	

\*1 The backlight life refers to the time until the brightness reduces by half after use at 25°C.

\*2 Brightness of the LCD only.

## Operation Specifications

Switching Element	Analog resistive membrane
Operating Force	0.55 to 2.3N
Mechanical Life	1,000,000 operations
Acknowledgement Sound	Electronic buzzer or speaker output

## Function Specifications

Screen Types	Base screen, popup screen, system screen
No. of Screens	Base screen: 3,000 max. Popup screen: 3,015 max.
User Memory	12 MB (including expansion fonts)
Parts	Bit Button, Word Button, Goto Screen, Print Button, Key Button, Multi Button, Keypad, Selector Switch, Potentiometer, Numerical Input, Character Input, Pilot Lamp, Multi-State Lamp, Picture Display, Message Display, Message Switching Display, Alarm List Display, Alarm Log Display, Numerical Display, Bar Graph, Trend Chart, Pie Chart, Meter, Calendar, Bit Write Command, Word Write Command, Goto Screen Command, Print Command, Timer, Screen Script Command, Multi Command, Video Display
Calendar	Year, Month, Day, Hour, Min., Sec., Day of Week ±60 sec per month (at 25°C)
Power Failure Backup Data	Calendar, log data, keep internal relay, keep internal register
Battery	Recommended replacement span: every 4 years (at 25°C)

## Interface Specifications



Serial Interface (COM1)	Electrical Characteristics	EIA RS232C/485 (422) compliant
	Transmission Speed	1200, 2400, 4800, 9600, 19200, 38400, 57600, 115200, 187500 bps (Note)
	Synchronization	Asynchronous
	Communication Method	Half or full duplex
Serial Interface (COM2)	Control System	Hardware control or none
	Connector	D-sub 9-pin connector
	Electrical Characteristics	EIA RS232C/485 (422) compliant
	Transmission Speed	1200, 2400, 4800, 9600, 19200, 38400, 57600, 115200, 187500 bps (Note)
Ethernet Interface (LAN)	Synchronization	Asynchronous
	Communication Method	Half or full duplex
	Control System	Hardware control or none
	Connector	Detachable 9-pin terminal block
Ethernet Interface (LAN)	Interface	IEEE802.3 (10/100BASE-T) compliant
	Connector	Modular connector (RJ-45)
Video Interface (VIDEO IN)	Interface	NTSC/PAL
	Connector	Pin jack
Audio Interface (AUDIO IN)	Interface	LINE IN (stereo)
	Connector	Mini jack connector (ø3.5 mm)
Audio Interface (AUDIO OUT)	Interface	LINE OUT (stereo)
	Connector	Mini jack connector (ø3.5 mm)
USB Interface (USB2)	Interface	USB 2.0 high speed (480 Mbps)
	Connector	USB Type A connector
USB Interface (USB1)	Interface	USB 2.0 high speed (480 Mbps)
	Connector	USB Type Mini-B connector
Memory Card Interface (SD)	Interface	SD memory card, SDHC memory card
	Connector	SD memory card socket
Expansion Module Interface (EXT)	Interface	MicroSmart I/O module interface
	Output current	5V 130 mA 24V 150 mA
	Max. no. of units	4 units

Note: 187,500 bps is available only with SIEMENS SIMATIC S7-300/400 series (MPI port direct connection).



8.4  
inch

# HG3G Operator Interface

Excellent visibility by super-bright LED backlight.  
600 cd/m<sup>2</sup> (8.4-inch)

Bright 600 cd/m <sup>2</sup>	TFT 65,536 Colors	LED 60,000 Hours	SVGA 800-600
48-level Brightness Adjustment	Graphics	Stroke Fonts	Serial Interface
Ethernet	USB mini-B	USB A	4 Expansion Modules
Audio Output	O/I Link	Cyclic Script	SD Card
USB Flash Drive	High Speed CPU	High Speed Data	User Memory 12MB
Pict Bridge	Front Panel Main- tenance	Audio Input	Video Input
Video Play	Video Recording	Voltage 24V DC	Vertical OK
Bezel Color			
	Light Gray	Dark gray	

\* Video recording function available soon (Note)

  (Approval for HG3G operator interface only, excluding options or expansion modules.)

Note: Programming software with video recording function will be available via free upgrade.  
For the latest information, visit our website at [www.idec.com](http://www.idec.com)

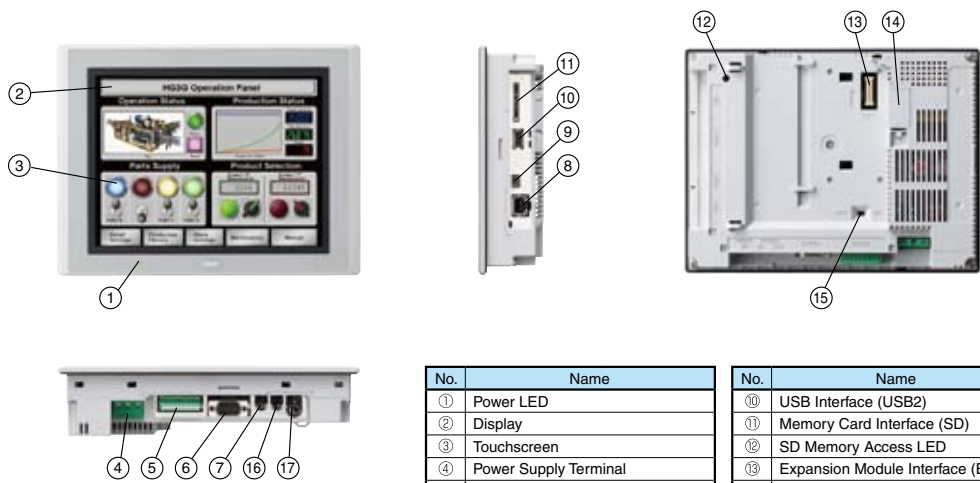

No.	Name
①	Power LED
②	Display
③	Touchscreen
④	Power Supply Terminal
⑤	Serial Interface (COM2)
⑥	Serial Interface (COM1)
⑦	Audio Interface (AUDIO OUT)
⑧	Ethernet Interface (LAN)
⑨	USB Interface (USB1)

No.	Name
⑩	USB Interface (USB2)
⑪	Memory Card Interface (SD)
⑫	SD Memory Access LED
⑬	Expansion Module Interface (EXT)
⑭	Battery Cover
⑮	Terminal Resistor Switch
⑯	Audio Interface (AUDIO IN)
⑰	Video Interface (VIDEO IN)

## HG3G Operator Interface

Display Screen	Operation Style	Communication/Memory Interface	Video/Audio Interface	Housing/Bezel Color	Part No. (Ordering No.)	Approvals
8.4-inch TFT color LCD 65,536 colors	Touch Switch (analog resistive)	COM1 COM2 LAN USB1 USB2 SD Memory Card	VIDEO IN AUDIO IN AUDIO OUT	Light gray	<b>HG3G-8JT22MF-W</b>	Safety Standards: UL508 CSA C22.2 No.142 CSA C22.2 No.213 ANSI/ISA-12.12.01-2007  Ship Classification Standards: ABS, LR, NR
				Dark gray	<b>HG3G-8JT22MF-B</b>	
			AUDIO OUT	Light gray	<b>HG3G-8JT22TF-W</b>	
				Dark gray	<b>HG3G-8JT22TF-B</b>	

\*DNV approval pending

## Dimensions

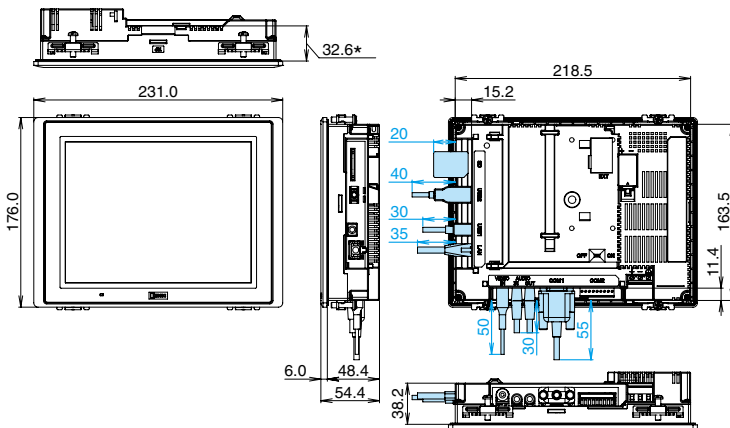

\*Depth from the expansion module mounting surface.

## Panel Cut-out

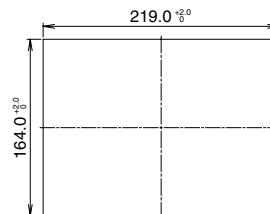

All dimensions in mm.

Note 1: Dimensions in blue show the mounting dimensions of the cable.

Note 2: Dimensions in the figure vary depending on the type of cable connected.

Note 3: Install the HG3G into a panel cut-out by tightening the four mounting clips (supplied) to a torque of 0.5 to 0.6 N-m.

Do not tighten with excessive force, otherwise the HG3G and screen may be distorted. Also waterproof characteristics may be lost.



## General Specifications

Model	HG3G-8 (8.4 inch)
Rated Power Voltage	24V DC
Power Voltage Range	20.4 to 28.8V DC
Power Consumption	25W maximum 15W maximum when not using USB interface (USB2) or expansion module interface (EXT)
Allowable Momentary Power Interruption	10 ms maximum
Inrush Current	30A maximum
Dielectric Strength	1,000V AC, 10 mA, 1 minute between power and FG terminals
Insulation Resistance	10 MΩ minimum between power and FG terminals (500V DC megger)
Operating Temperature	0 to +50°C (no freezing)
Operating Humidity	10 to 90% RH (no condensation)
Storage Temperature	-20 to +60°C (no freezing)
Storage Humidity	10 to 90% RH (no condensation)
Pollution Degree	2
Vibration Resistance	5 to 8.4 Hz amplitude 3.5 mm, 8.4 to 150 Hz, acceleration 9.8 m/s <sup>2</sup> 10 cycles (100 minutes) on each of three mutually perpendicular axes
Shock Resistance	147 m/s <sup>2</sup> , 11 ms 5 shocks on each of three mutually perpendicular axes
Noise Immunity	Fast transient/burst test, Power terminals: ±2 kV, Communication line: ±1 kV (IEC 61131-2: 2007)
Electrostatic Discharge	Contact ±6 kV, air ±8 kV (IEC 61131-2: 2007)
Corrosion Immunity	Free from corrosive gases
Mounting	Panel mounting
Degree of Protection	IP66 (IEC 60529) (front part when mounted) * TYPE 4X
Dimensions	231.0W × 176.0H × 54.4D mm
Weight (approx.)	1.25 kg

\* Do not use the HG3G in an environment subject to strong ultraviolet rays, otherwise the LCD quality will deteriorate.

\* Protection degree of the front surface after mounting. Operation not guaranteed under certain environments.

## Display Specifications

Model	HG3G-8 (8.4 inch)	
Display	TFT Color LCD	
Color/Shade	65,536 colors	
Effective Display Area	170.4W × 127.8H mm	
Display Resolution	800W × 600H pixels	
View Angle	Right and left 80°, up 80°, down 60°	
Backlight	LED	
Backlight Life	60,000 hours minimum *1	
Brightness	600 cd/m <sup>2</sup> *2	
Brightness Adjustment	48 levels	
Backlight Replacement	Not possible	
Display Character Size	1/4 size	8 × 8 pixels (Western European language: ISO 8859-1, Central European language: ANSI 1250, Baltic: ANSI 1257, Cyrillic: ANSI1251, Japanese katakana and symbols: JIS 8-bit code)
	1/2 size	8 × 16 pixels (Western European language: ISO 8859-1, Central European language: ANSI 1250, Baltic: ANSI 1257, Cyrillic: ANSI1251, Japanese katakana and symbols: JIS 8-bit code)
	Full size	16 × 32 pixels, 24 × 48 pixels, 32 × 64 pixels (Western European language: ISO 8859-1)
	Double size	16 × 16 pixels (Japanese JIS first and second level characters, simplified Chinese, traditional Chinese, Korean)
	Scalable	32 × 32 pixels (Japanese JIS first level characters, Mincho font) Width 8 to 128 dots (1/2 size fixed) (ISO 8859-1 western language, 7-segment)
Quantity of Characters	1/4 size	100 characters × 75 lines
	1/2 size	100 characters × 37 lines
	Full size	50 characters × 37 lines
	Double size	25 characters × 18 lines (Mincho font)
Character Magnification	0.5, 1, 2, 3, 4, and 8 vertically and horizontally (except for scalable fonts)	
Character Attribute	Blink (1 or 0.5 sec period), reverse, bold, shadowed	
Graphics	Straight line, polyline, rectangle, circle, ellipse, arc, pie, equilateral polygons (3, 4, 5, 6, 8), paint, bitmap image	
Window Display	3 popup screens + 1 system screen	

\*1 The backlight life refers to the time until the brightness reduces by half after use at 25°C.

\*2 Brightness of the LCD only.

## Operation Specifications

Switching Element	Analog resistive membrane
Operating Force	0.55 to 2.3N
Mechanical Life	1,000,000 operations
Acknowledgement Sound	Electronic buzzer or speaker output

## Function Specifications

Screen Types	Base screen, popup screen, system screen
No. of Screens	Base screen: 3,000 max. Popup screen: 3,015 max.
User Memory	12 MB (including expansion fonts)
Parts	Bit Button, Word Button, Goto Screen, Print Button, Key Button, Multi Button, Keypad, Selector Switch, Potentiometer, Numerical Input, Character Input, Pilot Lamp, Multi-State Lamp, Picture Display, Message Display, Message Switching Display, Alarm List Display, Alarm Log Display, Numerical Display, Bar Graph, Trend Chart, Pie Chart, Meter, Calendar, Bit Write Command, Word Write Command, Goto Screen Command, Print Command, Timer, Screen Script Command, Multi Command, Video Display
Calendar	Year, Month, Day, Hour, Min., Sec., Day of Week ±60 sec per month (at 25°C)
Power Failure Backup Data	Calendar, log data, keep internal relay, keep internal register
Battery	Recommended replacement span: every 4 years (at 25°C)

## Interface Specifications

Serial Interface (COM1)	Electrical Characteristics	EIA RS232C/485 (422) compliant
	Transmission Speed	1200, 2400, 4800, 9600, 19200, 38400, 57600, 115200, 187500 bps (Note)
	Synchronization	Asynchronous
	Communication Method	Half or full duplex
	Control System	Hardware control or none
	Connector	D-sub 9-pin connector
Serial Interface (COM2)	Electrical Characteristics	EIA RS232C/485 (422) compliant
	Transmission Speed	1200, 2400, 4800, 9600, 19200, 38400, 57600, 115200, 187500 bps (Note)
	Synchronization	Asynchronous
	Communication Method	Half or full duplex
	Control System	Hardware control or none
	Connector	Detachable 9-pin terminal block
Ethernet Interface (LAN)	Interface	IEEE802.3 (10/100BASE-T) compliant
	Connector	Modular connector (RJ-45)
Video Interface (VIDEO IN)	Interface	NTSC/PAL
	Connector	Pin jack
Audio Interface (AUDIO IN)	Interface	LINE IN (stereo)
	Connector	Mini jack connector (ø3.5 mm)
Audio Interface (AUDIO OUT)	Interface	LINE OUT (stereo)
	Connector	Mini jack connector (ø3.5 mm)
USB Interface (USB2)	Interface	USB 2.0 high speed (480 Mbps)
	Connector	USB Type A connector
USB Interface (USB1)	Interface	USB 2.0 high speed (480 Mbps)
	Connector	USB Type Mini-B connector
Memory Card Interface (SD)	Interface	SD memory card, SDHC memory card
	Connector	SD memory card socket
Expansion Module Interface (EXT)	Interface	MicroSmart I/O module interface
	Output current	5V 130 mA 24V 150 mA
	Max. no. of units	4 units

Note: 187,500 bps is available only with SIEMENS SIMATIC S7-300/400 series (MPI port direct connection).

5.7  
inch

# HG2G Operator Interface (High Performance)

Excellent visibility by super-bright LED backlight.  
800 cd/m<sup>2</sup> (5.7-inch)

Bright 800 cd/m <sup>2</sup>	TFT 65,536 Colors	LED 50,000 Hours	SVGA 640×480
48-level Brightness Adjustment	Graphics	Stroke Fonts	Serial Interface
Ethernet	USB mini-B	USB A	2 Expansion Modules
O/I Link	Cyclic Script	SD Card	USB Flash Drive
High Speed CPU	High Speed Data	User Memory 12MB	Pict Bridge
Front Panel Maintenance	Voltage 24V DC	Vertical OK	

Bezel Color: Light Gray, Dark gray, Silver

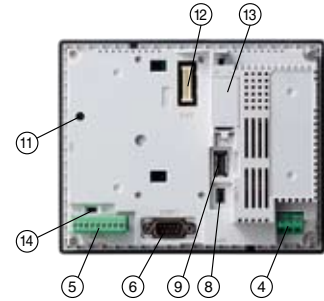
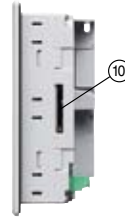
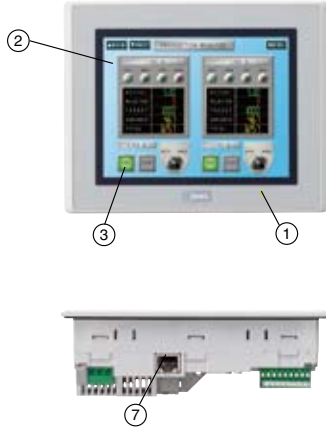

No.	Name
①	Power LED
②	Display
③	Touchscreen
④	Power Supply Terminal
⑤	Serial Interface (COM2)
⑥	Serial Interface (COM1)
⑦	Ethernet Interface (LAN)

No.	Name
⑧	USB Interface (USB1)
⑨	USB Interface (USB2)
⑩	Memory Card Interface (SD)
⑪	SD Memory Access LED
⑫	Expansion Module Interface (EXT)
⑬	Battery Cover
⑭	Terminal Resistor Switch

(Approval for HG2G operator interface only, excluding options or expansion modules.)

## HG2G Operator Interface

Display Screen	Operation Style	Communication/Memory Interface	Housing/Bezel Color	Part No. (Ordering No.)	Approvals
5.7-inch TFT color LCD 65,536 colors	Touch Switch (analog resistive)	COM1 COM2 LAN USB 1 USB 2 SD Memory Card	Light gray	<b>HG2G-5FT22TF-W</b>	Safety Standards: UL508 CSA C22.2 No.142  Ship Classification Standards: ABS, LR, NK
			Dark gray	<b>HG2G-5FT22TF-B</b>	
			Silver	<b>HG2G-5FT22TF-S</b>	

\*DNV approval pending

## Dimensions

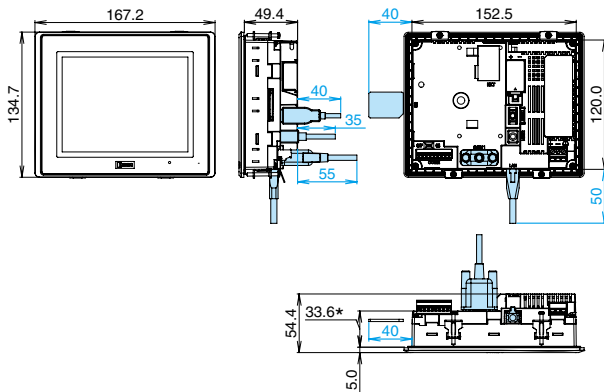

\*Depth from the expansion module mounting surface.

## Panel Cut-out

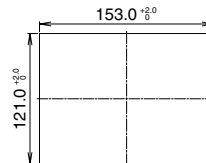

All dimensions in mm.

Note 1: Dimensions in blue show the mounting dimensions of the cable.

Note 2: Dimensions in the figure vary depending on the type of cable connected.

Note 3: Install the HG2G into a panel cut-out by tightening the four mounting clips (supplied) to a torque of 0.2 to 0.3 N-m.

Do not tighten with excessive force, otherwise the HG2G and screen may be distorted. Also waterproof characteristics may be lost.

# HG2G Operator Interface (High Performance)

## General Specifications

Rated Power Voltage	24V DC
Power Voltage Range	20.4 to 28.8V DC
Power Consumption	19W maximum 10W maximum when not using USB interface (USB2) or expansion module interface (EXT)
Allowable Momentary Power Interruption	10 ms maximum
Inrush Current	30A maximum
Dielectric Strength	1,000V AC, 10 mA, 1 minute between power and FG terminals
Insulation Resistance	10 MΩ minimum between power and FG terminals (500V DC megger)
Operating Temperature	0 to +50°C (no freezing)
Operating Humidity	10 to 90% RH (no condensation)
Storage Temperature	-20 to +60°C (no freezing)
Storage Humidity	10 to 90% RH (no condensation)
Pollution Degree	2
Vibration Resistance	5 to 8.4 Hz amplitude 3.5 mm, 8.4 to 150 Hz, acceleration 9.8 m/s <sup>2</sup> 10 cycles (100 minutes) on each of three mutually perpendicular axes
Shock Resistance	147 m/s <sup>2</sup> , 11 ms 5 shocks on each of three mutually perpendicular axes
Noise Immunity	Fast transient/burst test, Power terminals: ±1 kV, Communication line: ±0.5 kV (IEC/EN61131-2: 2007)
Electrostatic Discharge	ESD-3 (RH-1) Level 3 (Contact ±6 kV, air ±8 kV) (IEC/EN61131-2: 2007)
Corrosion Immunity	Free from corrosive gases
Mounting	Panel mounting
Degree of Protection	IP66 (IEC 60529) (front part when mounted) *
Dimensions	167.2W × 134.7H × 54.4D mm
Weight (approx.)	0.65 kg

- Do not use the HG2G in an environment subject to strong ultraviolet rays, otherwise the LCD quality will deteriorate.
- \* Protection degree of the front surface after mounting. Operation not guaranteed under certain environments.

## Display Specifications

Display Color	TFT Color LCD	
Color/Shade	65,536 colors	
Effective Display Area	115.2W × 86.4H mm	
Display Resolution	640W × 480H pixels	
View Angle	Right and left 80°, up 80°, down 80°	
Backlight	LED	
Backlight Life	50,000 hours *1	
Brightness	800 cd/m <sup>2</sup> *2	
Brightness Adjustment	48 levels	
Backlight Replacement	Not possible	
Display Character Size	1/4 size	8 × 8 pixels (Western European language: ISO 8859-1, Central European language: ANSI 1250, Japanese katakana and symbols: JIS 8-bit code)
	1/2 size	8 × 16 pixels (Western European language ISO 8859-1, Central European language: ANSI 1250, Japanese katakana and symbols: JIS 8-bit code)
		16 × 32 pixels, 24 × 48 pixels, 32 × 64 pixels (Western European language: ISO 8859-1)
	Full size	16 × 16 pixels (Japanese JIS first and second level characters, simplified Chinese, traditional Chinese, Korean)
	Double size	32 × 32 pixels (Japanese JIS first level characters, Mincho font)
	Scalable	Width 8 to 128 dots (1/2 size fixed) (ISO 8859-1 western language, 7-segment)
Quantity of Characters	1/4 size	80 characters × 60 lines
	1/2 size	80 characters × 30 lines
	Full size	40 characters × 30 lines
	Double size	20 characters × 15 lines (Mincho font)
Character Magnification	0.5, 1, 2, 3, 4, and 8 vertically and horizontally (except for scalable fonts)	
Character Attribute	Blink (1 or 0.5 sec period), reverse, bold, shadowed	
Graphics	Straight line, polyline, rectangle, circle, ellipse, arc, pie, equilateral polygons (3, 4, 5, 6, 8), paint, bitmap image	
Window Display	3 popup screens + 1 system screen	

\*1 The backlight life refers to the time until the brightness reduces by half after use at 25°C.

\*2 Brightness of the LCD only.

## Operation Specifications

Switching Element	Analog resistive membrane
Operating Force	3N maximum
Mechanical Life	1,000,000 operations
Acknowledgement Sound	Electronic buzzer

## Function Specifications

Screen Types	Base screen, popup screen, system screen
No. of Screens	Base screen: 3,000 max. Popup screen: 3,015 max.
User Memory	12 MB (including expansion fonts)
Parts	Bit Button, Word Button, Goto Screen, Print Button, Key Button, Multi Button, Keypad, Selector Switch, Potentiometer, Numerical Input, Character Input, Pilot Lamp, Multi-State Lamp, Picture Display, Message Display, Message Switching Display, Alarm List Display, Alarm Log Display, Numerical Display, Bar Graph, Trend Chart, Pie Chart, Meter, Calendar, Bit Write Command, Word Write Command, Goto Screen Command, Print Command, Timer, Screen Script Command, Multi Command
Calendar	Year, Month, Day, Hour, Min., Sec., Day of Week ±60 sec per month (at 25°C)
Power Failure Backup Data	Calendar, log data, keep internal relay, keep internal register
Battery	Recommended replacement span: every 4 years (at 25°C)

## Interface Specifications

Serial Interface (COM1)	Electrical Characteristics	EIA RS232C/485 (422) compliant
	Transmission Speed	1200, 2400, 4800, 9600, 19200, 38400, 57600, 115200, 187500 bps (Note)
	Synchronization	Asynchronous
	Communication Method	Half or full duplex
	Control System	Hardware control or none
Connector	D-sub 9-pin connector	
Serial Interface (COM2)	Electrical Characteristics	EIA RS232C/485 (422) compliant
	Transmission Speed	1200, 2400, 4800, 9600, 19200, 38400, 57600, 115200, 187500 bps (Note)
	Synchronization	Asynchronous
	Communication Method	Half or full duplex
	Control System	Hardware control or none
Connector	Detachable 9-pin terminal block	
Ethernet Interface (LAN)	Interface	IEEE802.3 (10/100BASE-T) compliant
	Connector	Modular connector (RJ-45)
USB Interface (USB2)	Interface	USB 2.0 high speed (480 Mbps)
	Connector	USB Type A connector
USB Interface (USB1)	Interface	USB 2.0 high speed (480 Mbps)
	Connector	USB Type Mini-B connector
Memory Card Interface (SD)	Interface	SD memory card, SDHC memory card
	Connector	SD memory card socket
Expansion Module Interface (EXT)	Interface	MicroSmart I/O module interface
	Output current	5V 130 mA 24V 150 mA
	Max. no. of units	4 units

Note: 187,500 bps is available only with SIEMENS SIMATIC S7-300/400 series (MPI port direct connection).

5.7  
inch

# HG2G Operator Interface (Basic/Color)

Enhanced visibility and user-friendly features.  
Stylish design with 3 different housing colors.  
Super bright 400 cd/m<sup>2</sup> LCD.

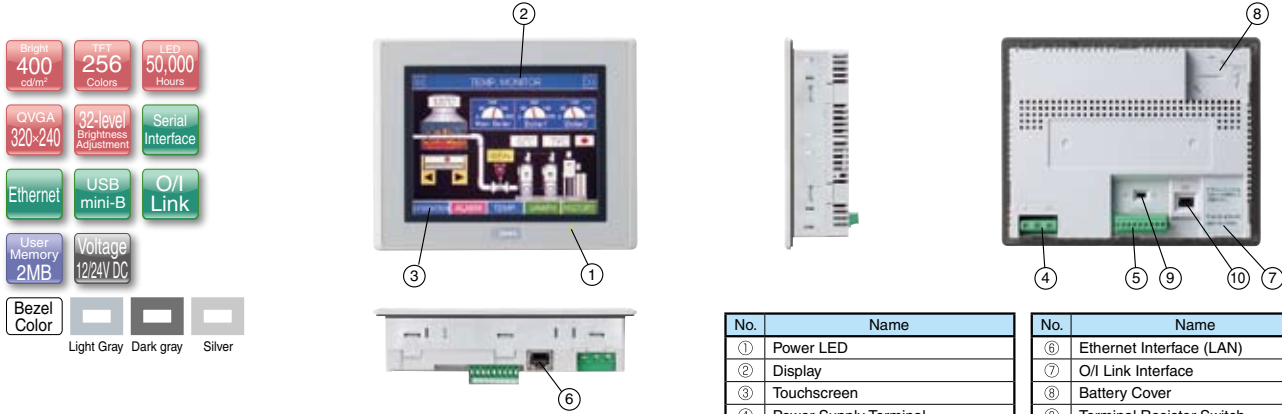

- Bright 400 cd/m<sup>2</sup>
- TFT 256 Colors
- LED 50,000 Hours
- QVGA 320x240
- 32-level Brightness Adjustment
- Serial Interface
- Ethernet
- USB mini-B
- O/I Link
- User Memory 2MB
- Voltage 12/24V DC
- Bezel Color: Light Gray, Dark gray, Silver

No.	Name
①	Power LED
②	Display
③	Touchscreen
④	Power Supply Terminal
⑤	Serial Interface 1

No.	Name
⑥	Ethernet Interface (LAN)
⑦	O/I Link Interface
⑧	Battery Cover
⑨	Terminal Resistor Switch
⑩	USB Interface

(Approval for HG2G operator interface only, excluding options or expansion modules.)

## HG2G Operator Interface

Operating Voltage	Display Screen	Operation Style	Communication Interface	Ethernet Interface	Power Failure Backup Data	Housing/ Bezel Color	Part No. (Ordering No.)	Approvals
12/24V DC	5.7-inch TFT color LCD 256 colors	Touch Switch (analog resistive)	RS232C/485 (422) USB	With	With	Light gray	HG2G-5ST22TF-W	UL508 CSA C22.2 No.142
						Dark gray	HG2G-5ST22TF-B	
						Silver	HG2G-5ST22TF-S	
			RS232C/485 (422) USB	Without	Without	Light gray	HG2G-5ST22VF-W	
						Dark gray	HG2G-5ST22VF-B	
						Silver	HG2G-5ST22VF-S	

### Dimensions

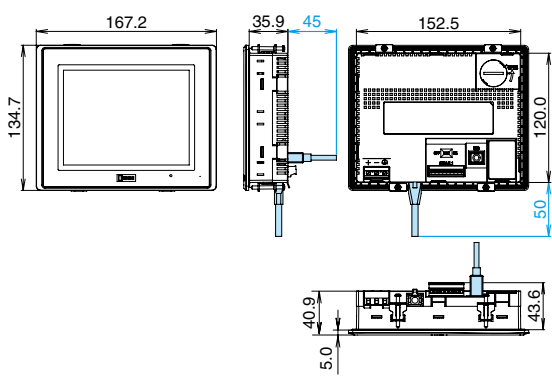

### Panel Cut-out

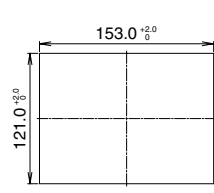

All dimensions in mm.

Note 1: Dimensions in blue show the mounting dimensions of the cable.  
 Note 2: Dimensions in the figure vary depending on the type of cable connected.  
 Note 3: Install the HG2G into a panel cut-out by tightening the four mounting clips (supplied) to a torque of 0.2 to 0.3 N-m.  
 Do not tighten with excessive force, otherwise the HG2G and screen may be distorted. Also waterproof characteristics may be lost.

# HG2G Operator Interface (Basic/Color)

## General Specifications

Model	HG2G-5S (Color)
Rated Power Voltage	12V DC/24 V DC
Power Voltage Range	10.2 to 28.8V DC
Power Consumption	8W maximum
Allowable Momentary Power Interruption	10 ms maximum
Inrush Current	40A maximum
Dielectric Strength	500V AC, 10 mA, 1 minute between power and FG terminals
Insulation Resistance	50 MΩ minimum between power and FG terminals (500V DC megger)
Operating Temperature	0 to +50°C (no freezing)
Operating Humidity	10 to 90% RH (no condensation)
Storage Temperature	-20 to +60°C (no freezing)
Storage Humidity	10 to 90% RH (no condensation)
Pollution Degree	2
Vibration Resistance	5 to 8.4 Hz amplitude 3.5 mm, 8.4 to 150 Hz, acceleration 9.8 m/s <sup>2</sup> 10 cycles (100 minutes) on each of three mutually perpendicular axes
Shock Resistance	147 m/s <sup>2</sup> , 11 ms 5 shocks on each of three mutually perpendicular axes
Noise Immunity	Fast transient/burst test, Power terminals: ±2 kV, Communication line: ±1 kV (IEC/EN61000-4-4)
Electrostatic Discharge	ESD-3 (RH-1) Level 3 (Contact ±6 kV, air ±8 kV) (IEC/EN61000-4-2)
Corrosion Immunity	Free from corrosive gases
Mounting	Panel mounting
Degree of Protection	IP66 (IEC 60529) (front part when mounted) *
Dimensions	167.2 W × 134.7 H × 40.9 D mm
Weight (approx.)	0.5 kg

- Do not use the HG2G in an environment subject to strong ultraviolet rays, otherwise the LCD quality will deteriorate.
- \* Protection degree of the front surface after mounting. Operation not guaranteed under certain environments.

## Display Specifications

Model	HG2G-5S (Color)	
Display	TFT Color LCD	
Color/Shade	256 colors	
Effective Display Area	115.2W × 86.4H mm	
Display Resolution	320W × 240H pixels	
View Angle	Right and left 70°, up 70°, down 60°	
Contrast Adjustment	Adjustable from the front of the panel	
Backlight	LED	
Backlight Life	50,000 hours minimum† *1	
Backlight Control	Automatic Off	
Brightness	400 cd/m <sup>2</sup> *2	
Brightness Adjustment	32 levels	
Backlight Replacement	Not possible	
Display Character Size	1/4 size	8 × 8 pixels (Western European language: ISO 8859-1, Central European language: ANSI 1250, Baltic: ANSI 1257, Cyrillic: ANSI1251, Japanese katakana and symbols: JIS 8-bit code)
	1/2 size	8 × 16 pixels (Western European language: ISO 8859-1, Central European language: ANSI 1250, Baltic: ANSI 1257, Cyrillic: ANSI1251, Japanese katakana and symbols: JIS 8-bit code) 16 × 32 pixels, 24 × 48 pixels, 32 × 64 pixels (Western European language: ISO 8859-1)
	Full size	16 × 16 pixels (Japanese JIS first and second level characters, simplified Chinese, traditional Chinese, Korean)
	Double size	32 × 32 pixels (Japanese JIS first level characters, Mincho font)
Quantity of Characters	1/4 size	40 characters × 30 lines
	1/2 size	40 characters × 15 lines
	Full size	20 characters × 15 lines
	Double size	10 characters × 7 lines
Character Magnification	0.5, 1, 2, 3, 4, and 8 vertically and horizontally	
Character Attribute	Blink (1 or 0.5 sec period), reverse, bold, shadowed	
Graphics	Straight line, polyline, rectangle, circle, ellipse, arc, pie, equilateral polygons (3, 4, 5, 6, 8), paint, bitmap image	
Window Display	3 popup screens + 1 system screen	

\*1 The backlight life refers to the time until the brightness reduces by half after use at 25°C.

\*2 Brightness of the LCD only.

## Operation Specifications

Switching Element	Analog resistive membrane
Operating Force	0.2 to 0.8N
Mechanical Life	1,000,000 operations
Acknowledgement Sound	Electronic buzzer

## Function Specifications

Screen Types	Base screen, popup screen, system screen
No. of Screens	Base screen: 3,000 max. Popup screen: 3,015 max.
User Memory	2 MB (including expansion fonts)
Parts	Bit Button, Word Button, Goto Screen, Key Button, Multi Button, Keypad, Selector Switch, Potentiometer, Numerical Input, Character Input, Pilot Lamp, Multi-State Lamp, Picture Display, Message Display, Message Switching Display, Alarm List Display, Alarm Log Display, Numerical Display, Bar Graph, Trend Chart, Pie Chart, Meter, Calendar, Bit Write Command, Word Write Command, Goto Screen Command, Screen Script Command, Multi Command, Timer
Calendar *	Year, Month, Day, Hour, Min., Sec., Day of Week ±60 sec per month (at 25 °C)
Power Failure Backup Data *	Calendar, log data, keep internal relay, keep internal register
Battery *	Recommended replacement span: every 4 years (at 25°C)

\* Not available for HG2G-5ST22VF.

## Interface Specifications

Serial Interface (COM1)	Electrical Characteristics	EIA RS232C compliant
	Transmission Speed	1200, 2400, 4800, 9600, 19200, 38400, 57600, 115200 bps
	Synchronization	Asynchronous
	Communication Method	Half or full duplex
	Control System	Hardware control or none
	Connector	D-sub 9-pin connector
Serial Interface (COM2) (Note 1)	Electrical Characteristics	EIA RS485 compliant
	Transmission Speed	1200, 2400, 4800, 9600, 19200, 38400, 57600, 115200, 187500 bps (Note 2)
	Synchronization	Asynchronous
	Communication Method	Half or full duplex
	Control System	Hardware control or none
	Connector	Detachable 9-pin terminal block
Ethernet Interface (LAN)	Interface	IEEE802.3 (10/100BASE-T) compliant
	Connector	Connector (RJ-45)
USB Interface	Interface	USB 2.0
	Connector	USB Type Mini-B connector (Note)
O/I Link Interface	Electrical Characteristics	EIA RS485 compliant
	Transmission Speed	19200, 38400, 57600, 115200 bps
	Synchronization	Asynchronous
	Communication Method	Half duplex
	Connector	3-pin terminal block

Note: 187,500 bps is available only with SIEMENS SIMATIC S7-300/400 series (MPI port direct connection).

5.7  
inch

# HG2G Operator Interface (Basic/Monochrome)

Enhanced visibility and user-friendly features.  
Stylish design with 3 different housing colors.  
Super bright 400 cd/m<sup>2</sup> LCD.

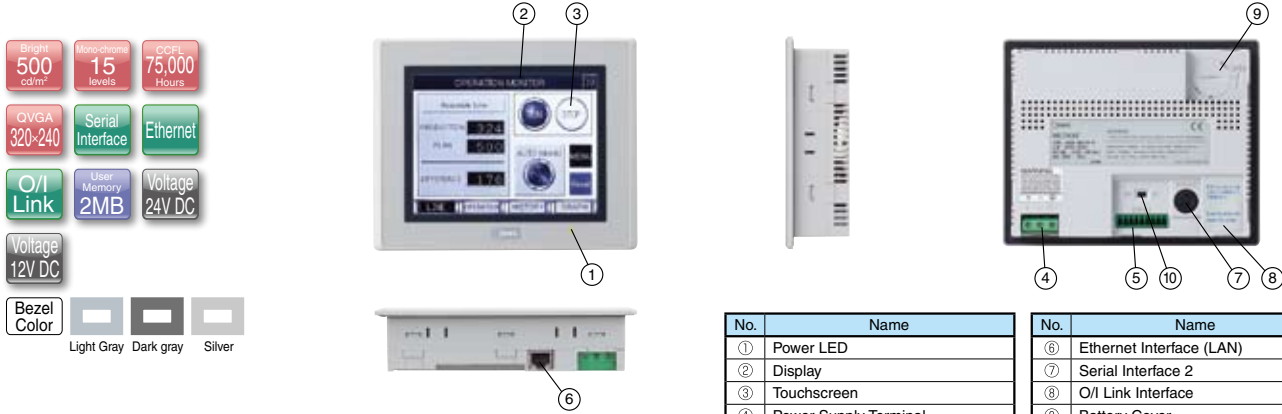

- Bright 500 cd/m<sup>2</sup>
- Monochrome 15 levels
- OCFL 75,000 Hours
- QVGA 320x240
- Serial Interface
- Ethernet
- O/Link
- User Memory 2MB
- Voltage 24V DC
- Voltage 12V DC
- Bezel Color: Light Gray, Dark gray, Silver

No.	Name
①	Power LED
②	Display
③	Touchscreen
④	Power Supply Terminal
⑤	Serial Interface 1

No.	Name
⑥	Ethernet Interface (LAN)
⑦	Serial Interface 2
⑧	O/I Link Interface
⑨	Battery Cover
⑩	Terminal Resistor Switch

(Approval for HG2G operator interface only, excluding options or expansion modules.)

## HG2G Operator Interface

Operating Voltage	Display Screen	Operation Style	Communication Interface	Ethernet Interface	Power Failure Backup Data	Housing/ Bezel Color	Part No. (Ordering No.)	Approvals
24V DC	5.7-inch STN monochrome LCD 15 shades	Touch Switch (analog resistive)	RS232C/485 (422)	With	With	Light gray	HG2G-SB22TF-W	UL508 UL1604 CSA C22.2 No.142 CSA C22.2 No.213
						Dark gray	HG2G-SB22TF-B	
						Silver	HG2G-SB22TF-S	
Without	Light gray	HG2G-SB22VF-W						
	Dark gray	HG2G-SB22VF-B						
	Silver	HG2G-SB22VF-S						
12V DC	5.7-inch STN monochrome LCD 15 shades	Touch Switch (analog resistive)	RS232C/485 (422)	With	Light gray	HG2G-SB21TF-W		
					Dark gray	HG2G-SB21TF-B		
					Silver	HG2G-SB21TF-S		
	Without	Light gray	HG2G-SB21VF-W					
		Dark gray	HG2G-SB21VF-B					
		Silver	HG2G-SB21VF-S					

## Dimensions

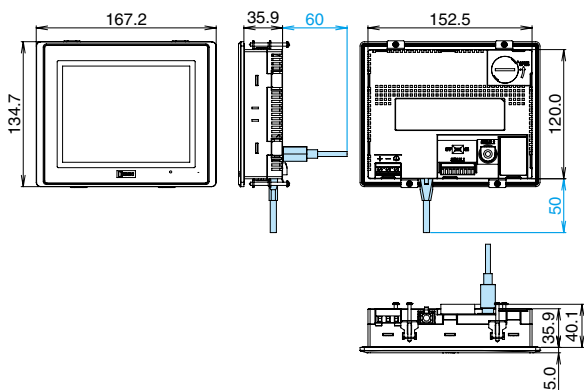

## Panel Cut-out

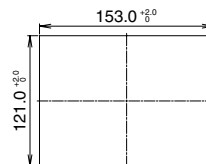

All dimensions in mm.

Note 1: Dimensions in blue show the mounting dimensions of the cable.

Note 2: Dimensions in the figure vary depending on the type of cable connected.

Note 3: Install the HG2G into a panel cut-out by tightening the four mounting clips (supplied) to a torque of 0.2 to 0.3 N-m.

Do not tighten with excessive force, otherwise the HG2G and screen may be distorted. Also waterproof characteristics may be lost.

# HG2G Operator Interface (Basic/Monochrome)

## General Specifications

Model	HG2G-S (monochrome)	
	24V DC	12V DC
Rated Power Voltage	24V DC	12V DC
Power Voltage Range	20.4 to 28.8V DC	10.2 to 18.0V DC
Power Consumption	10W maximum	
Allowable Momentary Power Interruption	10 ms maximum	
Inrush Current	20A maximum	40A maximum
Dielectric Strength	1,000V AC, 10 mA, 1 minute between power and FG terminals	
Insulation Resistance	50 MΩ minimum between power and FG terminals (500 V DC megger)	
Operating Temperature	0 to +50°C (no freezing)	
Operating Humidity	10 to 90% RH (no condensation)	
Storage Temperature	-20 to +60°C (no freezing)	
Storage Humidity	10 to 90% RH (no condensation)	
Pollution Degree	2	
Vibration Resistance	5 to 8.4 Hz amplitude 3.5 mm, 8.4 to 150 Hz, acceleration 9.8 m/s <sup>2</sup> 10 cycles (100 minutes) on each of three mutually perpendicular axes	
Shock Resistance	147 m/s <sup>2</sup> , 11 ms 5 shocks on each of three mutually perpendicular axes	
Noise Immunity	Fast transient/burst test, Power terminals: ±2 kV, Communication line: ±1 kV (IEC/EN61000-4-4)	
Electrostatic Discharge	ESD-3 (RH-1) Level 3 (Contact ±6 kV, air ±8 kV) (IEC/EN61000-4-2)	
Corrosion Immunity	Free from corrosive gases	
Mounting	Panel mounting	
Degree of Protection	IP65 (IEC 60529) (front part when mounted) *1, Type 13 *2	
Dimensions	167.2W × 134.7H × 40.9D mm	
Weight (approx.)	0.5 kg	

- Do not use the HG2G in an environment subject to strong ultraviolet rays, otherwise the LCD quality will deteriorate.
- \*1 Protection degree of the front surface after mounting. Operation not guaranteed under certain environments.
- \*2 Operation not guaranteed when used with certain types of oils.

## Display Specifications

Model		HG2G-S (monochrome)
Display		STN monochrome LCD
Color/Shade		15 shades
Effective Display Area		115.2W × 86.4H mm
Display Resolution		320W × 240H pixels
View Angle		Right and left 45°, up 25°, down 45°
Contrast Adjustment		Adjustable from the front of the panel
Backlight		CCFL
Backlight Life		75,000 hours minimum *1
Backlight Control		Automatic off
Brightness		500 cd/m <sup>2</sup> *2
Brightness Adjustment		32 levels
Backlight Replacement		Not possible
Display Character Size	1/4 size	8 × 8 pixels (Western European language: ISO 8859-1, Central European language: ANSI 1250, Baltic: ANSI 1257, Cyrillic: ANSI1251, Japanese katakana and symbols: JIS 8-bit code)
	1/2 size	8 × 16 pixels (Western European language: ISO 8859-1, Central European language: ANSI 1250, Baltic: ANSI 1257, Cyrillic: ANSI1251, Japanese katakana and symbols: JIS 8-bit code)
	Full size	16 × 32 pixels, 24 × 48 pixels, 32 × 64 pixels (Western European language: ISO 8859-1)
	Double size	16 × 16 pixels (Japanese JIS first and second level characters, simplified Chinese, traditional Chinese, Korean)
Quantity of Characters	1/4 size	32 × 32 pixels (Japanese JIS first level characters, Mincho font)
	1/2 size	40 characters × 30 lines
	Full size	40 characters × 15 lines
	Double size	20 characters × 15 lines
Character Magnification	0.5, 1, 2, 3, 4, and 8 vertically and horizontally	
Character Attribute	Blink (1 or 0.5 sec period), reverse, bold, shadowed	
Graphics	Straight line, polyline, rectangle, circle, ellipse, arc, pie, equilateral polygons (3, 4, 5, 6, 8), paint, bitmap image	
Window Display	3 popup screens + 1 system screen	

- \*1 The backlight life refers to the time until the brightness reduces by half after use at 25°C.
- \*2 Brightness of the LCD only.

## Operation Specifications

Switching Element	Analog resistive membrane
Operating Force	0.2 to 0.8N
Mechanical Life	1,000,000 operations
Acknowledgement Sound	Electronic buzzer

## Function Specifications

Screen Types	Base screen, popup screen, system screen
No. of Screens	Base screen: 3,000 max. Popup screen: 3,015 max.
User Memory	2 MB (including expansion fonts)
Parts	Bit Button, Word Button, Goto Screen, Key Button, Multi Button, Keypad, Selector Switch, Potentiometer, Numerical Input, Character Input, Pilot Lamp, Multi-State Lamp, Picture Display, Message Display, Message Switching Display, Alarm List Display, Alarm Log Display, Numerical Display, Bar Graph, Trend Chart, Pie Chart, Meter, Calendar, Bit Write Command, Word Write Command, Goto Screen Command, Timer, Screen Script Command, Multi Command
Calendar	Year, Month, Day, Hour, Min., Sec., Day of Week ±60 sec per month (at 25 °C)
Power Failure Backup Data	Calendar, log data, keep internal relay, keep internal register
Battery	Recommended replacement span: every 4 years (at 25°C)

## Interface Specifications

Serial Interface (COM1)	Electrical Characteristics	EIA RS232C compliant
	Transmission Speed	1200, 2400, 4800, 9600, 19200, 38400, 57600, 115200 bps
	Synchronization	Asynchronous
	Communication Method	Half or full duplex
	Control System	Hardware control or none
Serial Interface (COM2) (Note 1)	Connector	D-sub 9-pin connector
	Electrical Characteristics	EIA RS485 compliant
	Transmission Speed	1200, 2400, 4800, 9600, 19200, 38400, 57600, 115200, 187500 bps (Note 2)
	Synchronization	Asynchronous
	Communication Method	Half or full duplex
Ethernet Interface (LAN)	Control System	Hardware control or none
	Connector	Detachable 9-pin terminal block
	Interface	IEEE802.3 (10/100BASE-T) compliant
USB Interface	Connector	Connector (RJ-45)
	Interface	USB 2.0
O/I Link Interface	Connector	USB Type Mini-B connector (Note 3)
	Electrical Characteristics	EIA RS485 compliant
	Transmission Speed	19200, 38400, 57600, 115200 bps
	Synchronization	Asynchronous
	Communication Method	Half duplex
Connector	3-pin terminal block	

Note: 187,500 bps is available only with SIEMENS SIMATIC S7-300/400 series (MPI port direct connection).

# HG4G/3G/2G Operator Interface

## Options

Name	Part No. (Ordering No.)	Package Quantity	Description	Applicable Model				
				HG4G	HG3G	HG2G -5F	HG2G -5S	HG2G- S
Application Software	SW1A-W1C	1	Automation Organizer	√	√	√	√	√
USB Maintenance Cable (2m)	HG9Z-XCM22		Dsub 9-pin socket *1	—	—	—	—	√
	HG9Z-XCM42	1	USB Cable USB-miniB	√	√	√	√	—
PLC Connection Cable For IDEC MicroSmart (5m)	HG9Z-XC295	1	Mini DIN 8-pin (Dsub 9-pin)	√	√	√	—	—
PLC Connection Cable For Mitsubishi FX series (5m)	HG9Z-XC305	1	Mini DIN 8-pin (Dsub 9-pin)	√	√	√	—	—
PLC Connection Cable For Mitsubishi Q series (5m)	HG9Z-XC315	1	Mini DIN 6-pin (Dsub 9-pin)	√	√	√	—	—
PLC Connection Cable For IDEC MicroSmart (5m)	HG9Z-XC275	1	Mini DIN 8-pin (loose wire)	√	√	√	√	√
PLC Connection Cable For IDEC MicroSmart (2.4m)	FC2A-KP1C	1	Mini DIN 8-pin (loose wire)	√	√	√	√	√
USB panel-mount extension cable (1m)	HG9Z-XCE11	1	For USB-A port	√	√	√	—	—
	HG9Z-XCE21	1	For USB-mini B port	√	√	√	√	—
Connector Conversion Cable (16 cm)	HG9Z-XCT11	1	To convert from D-sub 25-pin to 9-pin (used when replacing from HG3F/4F to HG3G/4G)	√	√	√	—	—
Memory Card	HG9Z-XMS2	1	SD Memory Card (2GB)	√	√	√	—	—
Protective Cover	HG9Z-2E2PN03	3	For 5.7 inch (3 pcs/pack) (used to cover the front side of the operator interface)	—	—	√	√	√
Protective Sheet *2	HG9Z-2D5PN05	5	For 5.7 inch (5 pcs/pack)	—	—	√	√	√
	HG9Z-3D8PN02	2	For 8.4-inch (2 pcs/pack)	—	√	—	—	—
	HG9Z-3DA2PN02	2	For 10.4-inch (2 pcs/pack)	—	√	—	—	—
	HG9Z-4DCPN02	2	For 12.1 inch (2 pcs/pack)	√	—	—	—	—
Expansion Module Clamp *3	HG9Z-XJ3PN05	5	For installing the expansion modules on the back of the HG2G-5F/3G/4G (short). For total width 17.6 to 41.1 mm.	√	√	√	—	—
	HG9Z-XJ4PN05	5	For installing the expansion modules on the back of the HG2G-5F/3G/4G (long). For total width 47.0 to 68.8 mm.	√	√	√	—	—
	HG9Z-XJ5PN05	5	For installing the expansion modules on the back of the HG2G-5F/3G/4G (XL). For total width 70.1 to 93.9 mm.	√	√	√	—	—
L-shaped Terminal Block Connector for I/O Module *4	HG9Z-PMT10LPN02	2	For MicroSmart I/O Module (10-pole) (2 pcs/pack)	√	√	√	—	—
	HG9Z-PMT11LPN02	2	For MicroSmart I/O Module (11-pole) (2 pcs/pack)	√	√	√	—	—
O/I Link Unit	HG9Z-2G1	1	Communication unit for O/I link	—	—	—	√	√
Panel Mount Adaptor	HG9Z-2A1	1	Adaptor for mounting HG2G to the panel cut- out of HG2F.	—	—	√	√	√
	HG9Z-2A2	1	Adaptor for mounting HG2G to 156 x 123.5 mm panel cut-out.	—	—	√	√	√
User's Manual	HG9Y-B1119	1	English	√	√	√	√	√

\*1 Computer link cable (FC2A-KC4C) for IDEC's PLC can also be used.

\*2 The protective sheet is UV resistant, however, resistance against direct sunlight in outdoor usage is not guaranteed.  
Used to protect the display screen.

\*3 Use the expansion module clamp when using expansion modules.

Order the module clamp by referring to the width of the module shown in the dimensions of each module.

Note: When connecting more than 3 expansion modules to the HG3G/4G, note the limits shown below:

<Limits>

Current flow rate at 5V: 130 mA max. Total width: 92.3 mm max.

Current flow rate at 24V: 150 mA max.

\*4 See Cat No. P1373 or instruction manual for details on MicroSmart expansion modules.

## Maintenance Parts

Name	Part No. (Ordering No.)	Package Quantity	Description	Applicable Model				
				HG4G	HG3G	HG2G -5F	HG2G -5S	HG2G -S
Mounting Clip	SLD-K02PN10	10	Four clips are supplied.	—	—	√	√	√
	HG9Z-4K2PN04	4	Four clips are supplied.	√	√	—	—	—
Host Communication Plug	HG9Z-XT09V	1	One plug (terminal block type) is supplied.	—	—	√	√	—
	HG9Z-XT09	1	One plug (terminal block type) is supplied.	√	√	—	—	√
Replacement Battery	HG9Z-XR1	1	Lithium battery CR2032 (one battery is supplied)	√	√	√	√	√
USB Cable Lock Pin	HG9Z-XU1PN05	5	Used to lock USB cable (for USB2).	√	√	√	—	—



## Expansion Modules

### Input Modules

Input	Part No. (Ordering No.)	Connector	Dimensions (L x W x H mm)	Consumption Current (mA)	
				5V	24V
8 points/AC Input	FC4A-N08A11	Removable Terminal Block	90.0 x 23.5 x 70.0	25	0
8 points/DC Input	FC4A-N08B1		90.0 x 23.5 x 70.0	25	0
16 points/DC Input	FC4A-N16B1		90.0 x 23.5 x 70.0	40	0
16 points/DC Input	FC4A-N16B3	MIL Connector	90.0 x 17.6 x 70.0	35	0
32 points/DC Input	FC4A-N32B3		90.0 x 29.7 x 70.0	65	0

### Output Modules

Output	Part No. (Ordering No.)	Connector	Dimensions (L x W x H mm)	Consumption Current (mA)	
				5V	24V
8 points/Relay Output	FC4A-R081	Removable Terminal Block	90.0 x 23.5 x 70.0	30	40
16 points/Relay Output	FC4A-R161		90.0 x 23.5 x 70.0	45	75
8 points/Transistor Sink Output	FC4A-T08K1		90.0 x 23.5 x 70.0	10	20
8 points/Transistor Source Output	FC4A-T08S1		90.0 x 23.5 x 70.0	10	20
16 points/Transistor Sink Output	FC4A-T16K3	MIL Connector	90.0 x 17.6 x 70.0	10	40
16 points/Transistor Source Output	FC4A-T16S3		90.0 x 17.6 x 70.0	10	40
32 points/Transistor Sink Output	FC4A-T32K3		90.0 x 29.7 x 70.0	20	70
32 points/Transistor Source Output	FC4A-T32S3		90.0 x 29.7 x 70.0	20	70

### Combination I/O Modules

Input/Output	Part No. (Ordering No.)	Connector	Dimensions (L x W x H mm)	Consumption Current (mA)	
				5V	24V
4 points/DC Input 4 points/Relay Output	FC4A-M08BR1	Removable Terminal Block	90.0 x 23.5 x 70.0	25	20
16 points/DC Input 8 points/Relay Output	FC4A-M24BR2	Non-removable Terminal Block	90.0 x 39.1 x 70.0	65	45

- Use the expansion module clamp when using expansion modules.  
Order the module clamp by referring to the width of the module shown in the dimensions of each module.  
Note: When connecting more than 3 expansion modules to the HG3G/4G, note the limits shown below:  
<Limits>  
Current flow rate at 5V: 130 mA max. Total width: 92.3 mm max.  
Current flow rate at 24V: 150 mA max.
- See Cat No. P1373 or instruction manual for details on MicroSmart expansion modules.

# HG4G/3G/2G Operator Interface

## Compatible PLCs

Manufacturer	Series	Applicable models	
		HG4G HG3G HG2G-5F	HG2G-S HG2G-5S
IDEC	MICROSmart	✓	✓
	MICROSmart Pentra	✓	✓
Mitsubishi	MELSEC-A (link unit)	✓	✓
	MELSEC-A (connects to CPU)	—	—
	MELSEC-QnA	✓	✓
	MELSEC-Q (link unit)	✓	✓
	MELSEC-Q (Ethernet)	✓	✓
	Q02CPU-A mode	—	—
	MELSEC-FX	✓	✓
OMRON	SYSMAC-C	✓	✓
	SYSMAC-CS1	✓	✓
	SYSMAC-CJ1	✓	✓
	SYSMAC-CJ2	✓	✓
	SYSMAC-CP1H	✓	✓
Allen-Bradley	PLC-5	—	✓
	SLC-500 (Half Duplex)	—	✓
	MicroLogix (Full Duplex)	✓	✓
	ControlLogix	—	—
	CompactLogix	✓	✓
	FlexLogix	—	—
	ControlLogix (Ethernet/IP)	—	—
	CompactLogix (Ethernet/IP)	✓	✓
	PLC-5 (Ethernet/IP)	—	—
	SLC 500	✓	✓
MicroLogix	—	—	
SIEMENS	S7-200	✓	✓
	S7-300 (connects to CPU)	✓	✓
	S7-300 (link unit)	✓	✓
	S7-400	—	—
Keyence	KV-700 KV-1000	✓	✓
	KZ	—	✓
	KV	—	—
	KV (Ethernet)	✓	✓

Manufacturer	Series	Applicable models	
		HG4G HG3G HG2G-5F	HG2G-S HG2G-5S
SHARP	New Satellite JW	—	✓
HITACHI	S10mini	—	✓
	S10V	—	—
JTEKT	TOYOPUC-PC2J	✓	✓
	TOYOPUC-PC3J	—	—
Toshiba Machine Works	TC200	—	✓
	TCmini	—	—
GE Fanuc Automation	Series 90-30	✓	✓
	VersaMax	—	—
Schneider	Twido	✓	✓
Modicon	Momentum	✓	✓
	MODBUS/TCP Server	✓	✓
Panasonic	FP Series	✓	✓
YASKAWA Electric	Machine Controller	✓	✓
Koyo	DirectLOGIC 05	—	—
	DirectLOGIC 06	✓	✓
	DirectLOGIC 205	—	—
	KOSTAC SZ	✓	✓
	KOSTAC SU (Ethernet)	✓	✓
FANUC	Power Mate	—	—
	Series	✓	✓
Yokogawa Electric	FACTORY ACE	✓	✓
Fuji Electric	FREX-PC	✓	✓
	MICREX-F	✓	✓
TOSHIBA	PROSEC T Series	✓	✓
	V Series	✓	✓
LS Industrial Systems	MASTER-K	✓	✓
VIGOR	VB	✓	✓
	VH	—	—

- The company names and product names are registered trademarks or brand names.
- The compatible PLC information is for reference only (except for IDEC PLCs), and IDEC does not guarantee the operation of any other manufacturers' PLC. When using other manufacturers' PLCs, read their specifications and instruction manual carefully. The PLC must be operated correctly under the user's responsibility.

An updated listing of compatible PLCs can be found at the following website.  
<http://www.idec.com/oi/drivers>

Specifications and other descriptions in this catalog are subject to change without notice.



## IDEC CORPORATION

7-31, Nishi-Miyahara 1-Chome, Yodogawa-ku, Osaka 532-8550, Japan  
 Tel: +81-6-6398-2571, Fax: +81-6-6392-9731  
 E-mail: marketing@idec.co.jp

**IDEC CORPORATION (USA)**  
 1175 Elko Drive, Sunnyvale,  
 CA 94089-2209, USA  
 Tel: +1-408-747-0550 / (800) 262-IDECA (4332)  
 Fax: +1-408-744-9055 / (800) 635-6246  
 E-mail: opencontact@idec.com

**IDEC CANADA LIMITED**  
 3155 Pepper Mill Court, Unit 4, Mississauga,  
 Ontario, L5L 4X7, Canada  
 Tel: +1-905-890-8561, Toll Free: (888) 317-4332  
 Fax: +1-905-890-8562  
 E-mail: sales@ca.idec.com

**IDEC AUSTRALIA PTY. LTD.**  
 Unit 17, 104 Ferntree Gully Road,  
 Oakleigh, Victoria 3166, Australia  
 Tel: +61-3-8523-5900, Toll Free: 1800-68-4332  
 Fax: +61-3-8523-5999  
 E-mail: sales@au.idec.com

**IDEC ELECTRONICS LIMITED**  
 Unit 2, Beechwood, Chineham Business Park,  
 Basingstoke, Hampshire RG24 8WA, UK  
 Tel: +44-1256-321000, Fax: +44-1256-327755  
 E-mail: sales@uk.idec.com

**IDEC ELEKTROTECHNIK GmbH**  
 Wendenstrasse 331, 20537 Hamburg, Germany  
 Tel: +49-40-25 30 54 - 0, Fax: +49-40-25 30 54 - 24  
 E-mail: service@idec.de

**IDEC (SHANGHAI) CORPORATION**  
 Room 608-609, 6F, Gangtai Plaza, No. 700,  
 Yan'an East Road, Shanghai 200001, PRC  
 Tel: +86-21-5353-1000, Fax: +86-21-5353-1263  
 E-mail: idec@cn.idec.com

**IDEC (BEIJING) CORPORATION**  
 Room 211B, Tower B, The Grand Pacific Building,  
 8A Guanghua Road, Chaoyang District,  
 Beijing 100026, PRC  
 Tel: +86-10-6581-6131, Fax: +86-10-6581-5119

**IDEC (SHENZHEN) CORPORATION**  
 Unit AB-3B2, Tian Xiang Building, Tian'an Cyber Park,  
 Fu Tian District, Shenzhen, Guang Dong 518040, PRC  
 Tel: +86-755-8356-2977, Fax: +86-755-8356-2944

**IDEC IZUMI (H.K.) CO., LTD.**  
 Units 11-15, Level 27, Tower 1,  
 Millennium City 1, 388 Kwun Tong Road,  
 Kwun Tong, Kowloon, Hong Kong  
 Tel: +852-2803-8989, Fax: +852-2565-0171  
 E-mail: info@hk.idec.com

**IDEC TAIWAN CORPORATION**  
 8F-1, No. 79, Hsin Tai Wu Road, Sec. 1,  
 Hsi-Chih District, New Taipei City, Taiwan  
 Tel: +886-2-2698-3929, Fax: +886-2-2698-3931  
 E-mail: service@tw.idec.com

**IDEC IZUMI ASIA PTE. LTD.**  
 No. 31, Tannery Lane #05-01,  
 HB Centre 2, Singapore 347788  
 Tel: +65-6746-1155, Fax: +65-6844-5995  
 E-mail: info@sg.idec.com