



I-SYS





Carl Stahl is a leading worldwide manufacturer of cable and lifting equipment.

What started out in 1880 as a small rope maker specialised in agricultural products, serving only local customers, has now become a global enterprise with over 1000 employees operating from more than 50 subsidiaries around the world.

Classical applications for cables in mechanical engineering, ship building and the construction industry are today being complemented by new high-tech sectors from medical technology through to automotive industry.

Professional know-how and the motivation of our employees is our major strength; customer satisfaction as our main objective is not just a statement, it is our commitment! All activities are focused on providing customers with real benefits through the products and services we supply; our customers' requirements are our major concerns.

Our thoughts are always guided by the conviction that quality is the decisive factor in global competition. Therefore we are organized according to DIN ISO 9001:2008 (management system) and to DIN ISO 14001:2004 (environmental management).

One of the most recent areas of activity within the company is the development and design of the stainless steel cable system I-SYS, and the stainless steel cable mesh X-TEND, both targeted towards the world of architecture.

Quality, innovation and service from a customer-oriented organization: the right combination to meet future challenges.

**Published by**

Carl Stahl GmbH, Suessen

Photos

Products and applications: Kuhnle + Knoedler, Radolfzell,
Foto Design Kissner, Bad Ueberkingen / Hausen
Small products in the tables: Axel Waldecker, Murr

Projects

Page 6
Stiftskirche, Stuttgart
Collaboration: Carl Stahl
Photos: Hans-Georg Esch, Hennef/Sieg

© 2011

Carl Stahl GmbH
Tobelstr. 2 | 73079 Suessen | Germany
www.carlstahl-architektur.de | architektur@carlstahl.com

Exclusion of liability

All information is given with the intention of accuracy and completeness. Carl Stahl would appreciate any information regarding errors or missing items. All information in this catalogue is valid at the time of printing. The right is retained to make changes related to continuous improvement of the product range or errors.

Copyright

The catalogue is the intellectual property of Carl Stahl GmbH. Carl Stahl GmbH expressly retains rights of ownership and copyright with regard to the information in the catalogue. Reprinting and reproduction of the text, including in part, is only permitted with the prior written permission of Carl Stahl GmbH.

I-SYS: Advice and Planning | Expertise and Creativity 6

External Threads 8

Internal Threads 16

Forks 22

Eyes 34

End Stops 44

Cables | Loops | Clamps | Accessories 52

I-SYS: Greenery 70

Assured Safety 73

Technology 74

Dimensions 76

Key 77

Carl Stahl: System solutions | custom-made products 78

Carl Stahl: Product Range 79



I-SYS:

Advice and Planning

I-SYS includes components, combinations and individual applications. Above all, I-SYS constitutes an invitation to cooperative action. The experts from Carl Stahl offer advice and plan small and large projects, they inspire architects to find the most aesthetically satisfying solutions and supply static calculations. A service which is as rapid as it is professional and which is in demand all over the world. The range of expertise of our specialists ranges from the first idea, through truly exceptional development, up to manufacture, assembly and subsequent service.

I-SYS:

Expertise and Creativity

I-SYS, the stainless steel architectural range, transforms visions into reality. I-SYS offers both form and function to the architect, with a superb range of literally thousands of components and assemblies. I-SYS products can be used for many applications from small decorative projects to high load cables for tensile structures.

I-SYS offers functionality, consistent quality, creativity of application and prize winning design. General planning authority approval of many components, successful test programs and a number of company patents typify the professionalism of the range. Stainless steel material allows durable, cost effective and low maintenance solutions to be created. I-SYS sets worldwide standards of modern construction for architects, engineers and fabricators.





I-SYS: External Threads

Stainless steel cables are turned into universal elements by means of useful connectors, fittings and guides. They have to be strong in order to take up the forces which occur and at the same time they must harmonise with the architecture. A performance which the individual components of I-SYS negotiate with the greatest of ease. Including the jewel in the crown, the F50, a hammered external thread which brings together different diameters of stainless steel cable and final connectors in a perfect interference fit.



External thread F50 hammered

Part number RH thread	Part number LH thread	ø rope	a	b	c	ø d ^{+0,2} ₀	kN
950-0400-30	951-0400-30	4	M4	55	30	4,4	5,3
950-0400-60	951-0400-60	4	M4	85	60	4,4	5,3
950-0500-30	951-0500-30	5	M5	60	30	5,5	8,4
950-0500-60	951-0500-60	5	M5	90	60	5,5	8,4
950-0600-30	951-0600-30	6	M6	66	30	6,6	12,1
950-0600-60	951-0600-60	6	M6	96	60	6,6	12,1
950-0800-30	951-0800-30	8	M8	90	30	8,8	21,5
950-0800-60	951-0800-60	8	M8	120	60	8,8	21,5

Material 1.4404 | Not suitable for strands

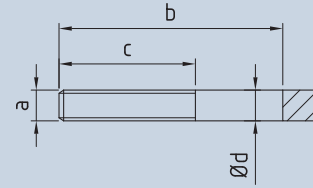

External thread F30 hammered

Part number RH thread	Part number LH thread	ø rope	a	b	c	ø d ±0,2	kN
948-0300-20	949-0300-20	3	M4	37	20	3,9	4
948-0300-40	949-0300-40	3	M4	57	40	3,9	4
948-0400-30	949-0400-30	4	M5	50	30	4,9	7,1
948-0400-50	949-0400-50	4	M5	70	50	4,9	7,1
948-0500-30	949-0500-30	5	M6	55	30	5,9	11,2
948-0500-50	949-0500-50	5	M6	75	50	5,9	11,2
948-0600-30	949-0600-30	6	M8	58	30	7,9	16
948-0600-60	949-0600-60	6	M8	88	60	7,9	16
948-0800-30	949-0800-30	8	M10	68	30	9,9	25
948-0800-60	949-0800-60	8	M10	98	60	9,9	25
948-1000-30	949-1000-30	10	M12	76	30	11,9	41,6
948-1000-60	949-1000-60	10	M12	106	60	11,9	41,6

Material 1.4404 | Not suitable for strands

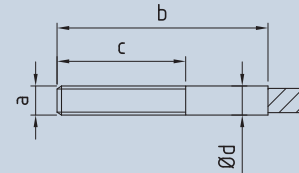

External thread swaged

Part number RH thread	Part number LH thread	ø rope	a	b	c	ø d	kN
850-0100-020	855-0100-020	1	M4	35	20	4	0,5
850-0200-030	855-0200-030	2	M5	55	30	5	2,8
850-0200-060	855-0200-060	2	M5	85	60	5	2,8
850-0300-030	855-0300-030	3	M6	70	30	6	6,3
850-0300-060	855-0300-060	3	M6	100	60	6	6,3
850-0400-030	855-0400-030	4	M6	75	30	7	11,2
850-0400-060	855-0400-060	4	M6	105	60	7	11,2
850-0400-061	855-0400-061	4	M8	105	60	8	11,2
850-0500-030	855-0500-030	5	M8	80	30	8	17,5
850-0500-060	855-0500-060	5	M8	110	60	8	17,5
850-0500-080	855-0500-080	5	M8	130	80	8	17,5
850-0600-030	855-0600-030	6	M10	90	30	10	25,2
850-0600-060	855-0600-060	6	M10	120	60	10	25,2
850-0600-080	855-0600-080	6	M10	140	80	10	25,2
850-0800-080	855-0800-080	8	M12	170	80	13	39,5
850-0800-120	855-0800-120	8	M12	210	120	13	39,5
850-1000-115	855-1000-115	10	M16	225	115	18	61,7
850-1200-130	855-1200-130	12	M20	245	130	20	83,2
850-1600-160	855-1600-160	16	M24	290	160	27	140

Material 1.4404

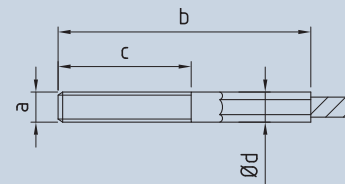



External thread roll swaged

Part number

RH thread	LH thread	ø rope a	b	c	ø d	
650-0600-045	655-0600-045	6	M10	117	45	12,5
650-0800-060	655-0800-060	8	M12	156	60	16,1
650-1000-076	655-1000-076	10	M14	193	76	17,8
650-1200-090	655-1200-090	12	M16	232	90	21,4
650-1400-110	655-1400-110	14	M20	259	110	24,9
650-1600-130	655-1600-130	16	M24	313	130	28
650-1800-140	655-1800-140	18	M27	357	140	34,5
650-2200-170	655-2200-170	22	M30	430	170	43
650-2600-170	655-2600-170	26	M36	475	170	45,9

Material 1.4404 | European Technical Approval ETA-10/0358 granted

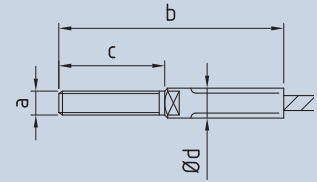

External thread swageless connection

Part number RH thread	Part number LH thread	ø rope a	ø d	b	c	kN	
826-0200-030	827-0200-030	2	M6	13	85	30	2
826-0200-060	827-0200-060	2	M6	13	115	60	2
826-0300-030	827-0300-030	3	M6	13	85	30	4,5
826-0300-060	827-0300-060	3	M6	13	115	60	4,5
826-0400-030	827-0400-030	4	M6	13	85	30	8
826-0400-060	827-0400-060	4	M6	13	115	60	8
826-0500-030	827-0500-030	5	M8	15	87	30	12,6
826-0500-060	827-0500-060	5	M8	15	117	60	12,6
826-0600-030	827-0600-030	6	M8	15	87	30	18,1
826-0600-060	827-0600-060	6	M8	15	117	60	18,1
826-0800-080	827-0800-080	8	M10	20	167	80	32,2
826-1000-100	827-1000-100	10	M14	28	223	100	46,8
826-1200-120	827-1200-120	12	M16	30	257	120	67,6

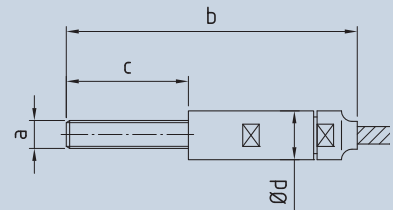

Material 1.4404 | Not suitable for strand 1 x 19





External thread swivel swaged

Part number	ø rope a	b	c	ø d	kN	
856-0300-030	3	M6	88	30	10	4,5
856-0300-060	3	M6	118	60	10	4,5
856-0400-030	4	M6	88	30	10	8,1
856-0400-060	4	M6	118	60	10	8,1
856-0400-061	4	M8	118	60	10	8,1
856-0500-030	5	M8	108	30	13	12,6
856-0500-080	5	M8	158	80	13	12,6
856-0600-060	6	M10	138	60	13	14,5

Material 1.4404 | Not suitable for strand 1 x 19

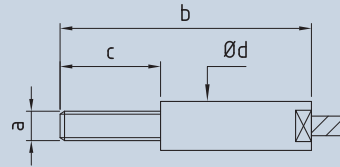

Turnbuckle with external threads swaged

Part number	ø rope a	b1	b2	ø d	Adjustment	kN	
829-0200-01	2	M5	166	80	8	+16 -26	2,8
829-0200-02	2	M5	211	80	8	+30 -40	2,8
829-0300-01	3	M6	207	92	10	+14 -26	6,3
829-0300-02	3	M6	250	92	10	+32 -44	6,3
829-0400-01	4	M6	217	92	10	+14 -26	11,2
829-0400-02	4	M6	260	92	10	+32 -44	11,2
829-0400-03	4	M8	270	112	13,5	+38 -54	11,2
829-0500-01	5	M8	248	112	13,5	+8 -24	17,5
829-0500-02	5	M8	280	112	13,5	+38 -54	17,5
829-0600-01	6	M10	314	120	17,2	+8 -50	25,2
829-0600-02	6	M10	340	120	17,2	+40 -60	25,2
829-0800-01	8	M12	425	150	21,3	+46 -70	39,5
829-1000-01	10	M16	560	190	26,9	+62 -94	61,7
829-1200-01	12	M20	646	220	33,7	+70 -110	83,2
829-1600-01	16	M24	858	328	50	+92 -140	140

Material 1.4404 | Left/right swaged external threads are screwed half way into the turnbuckle. The minimum screw-in depth is 1.5 x thread ø (M8=12 mm).

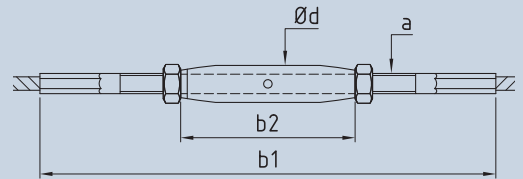

Turnbuckle with external threads F30 hammered

Part number	ø rope a	b1	b2	ø d	Adjustment	kN	
828-0400-02	4	M5	160	80	8	+38 -42	7,1
828-0500-02	5	M6	178	92	10	+32 -40	11,2
828-0600-02	6	M8	214	112	13,5	+36 -47	16
828-0800-02	8	M10	236	120	17,2	+30 -44	25
828-1000-02	10	M12	280	150	21,3	+24 -40	41,6

Material 1.4404 | Left/right hammered external threads are screwed half way into the turnbuckle. The minimum screw-in depth is 1.5 x thread ø (M8=12 mm).

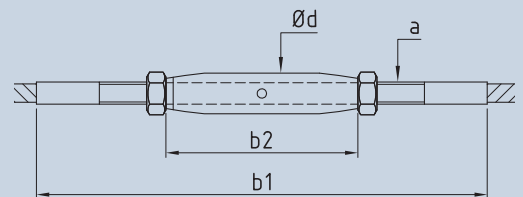



Both sides external thread swaged

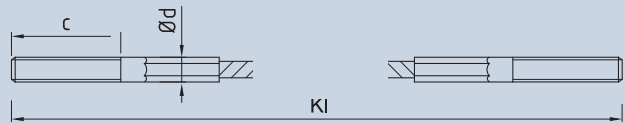

Part number both sides RH thread	Part number one LH thread one RH thread	Ø rope Sk	Thread size x length c	Ø d
IK 100-0200	IK 101-0200	2	7 x 7 M5 x 30	5
IK 100-0201	IK 101-0201	2	7 x 7 M5 x 60	5
IK 100-0300	IK 101-0300	3	7 x 7 M6 x 30	6
IK 100-0301	IK 101-0301	3	7 x 7 M6 x 60	6
IK 100-0400	IK 101-0400	4	7 x 7 M6 x 30	7
IK 100-0401	IK 101-0401	4	7 x 7 M6 x 60	7
IK 100-0500	IK 101-0500	5	7 x 7 M8 x 30	8
IK 100-0501	IK 101-0501	5	7 x 7 M8 x 60	8
IK 100-0600	IK 101-0600	6	7 x 7 M10 x 30	10
IK 100-0601	IK 101-0601	6	7 x 7 M10 x 60	10
IK 100-0800	IK 101-0800	8	7 x 7 M12 x 80	13
IK 100-1000	IK 101-1000	10	7 x 19 M16 x 115	18
IK 100-1200	IK 101-1200	12	7 x 19 M20 x 130	20
IK 100-1600	IK 101-1600	16	7 x 19 M24 x 160	27



**Both sides turnbuckle
with external thread swaged**

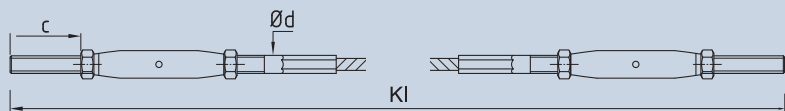

Part number both sides RH thread	Ø rope Sk	Thread size x length c	Adjustment	Ø d
IK 110-0200	2	7 x 7 M5 x 60	+52 -86	5
IK 110-0300	3	7 x 7 M6 x 60	+56 -100	6
IK 110-0400	4	7 x 7 M6 x 60	+56 -100	7
IK 110-0500	5	7 x 7 M8 x 60	+68 -100	8
IK 110-0600	6	7 x 7 M10 x 60	+60 -100	10
IK 110-0800	8	7 x 7 M12 x 60	+92 -140	13
IK 110-1000	10	7 x 19 M16 x 60	+96 -180	18
IK 110-1200	12	7 x 19 M20 x 60	+120 -210	20
IK 110-1600	16	7 x 19 M24 x 60	+180 -240	27



Both sides external thread F30 hammered

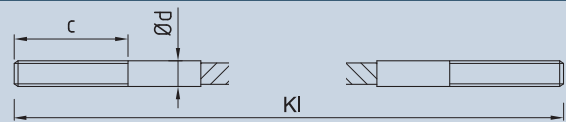

Part number both sides RH thread	Part number one LH thread one RH thread	Ø rope Sk	Thread size x length c	Ø d ±0,2
IK 120-0300	IK 121-0300	3	7 x 7 M4 x 20	3,9
IK 120-0301	IK 121-0301	3	7 x 7 M4 x 40	3,9
IK 120-0400	IK 121-0400	4	7 x 7 M5 x 30	4,9
IK 120-0401	IK 121-0401	4	7 x 7 M5 x 50	4,9
IK 120-0500	IK 121-0500	5	7 x 7 M6 x 30	5,9
IK 120-0501	IK 121-0501	5	7 x 7 M6 x 50	5,9
IK 120-0600	IK 121-0600	6	7 x 7 M8 x 30	7,9
IK 120-0601	IK 121-0601	6	7 x 7 M8 x 60	7,9
IK 120-0800	IK 121-0800	8	7 x 7 M10 x 30	9,9
IK 120-0801	IK 121-0801	8	7 x 7 M10 x 60	9,9
IK 120-1000	IK 121-1000	10	7 x 19 M12 x 30	11,9
IK 120-1001	IK 121-1001	10	7 x 19 M12 x 60	11,9



Both sides external thread F50 hammered

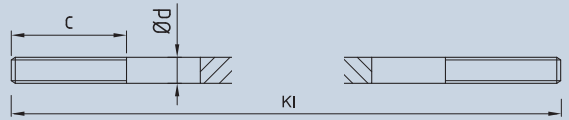

Part number both sides RH thread	Part number one LH thread one RH thread	Ø rope Sk	Thread size x length c	Ø d ^{+0,2} ₀
IK 125-0400	IK 126-0400	4 7 x 7	M4 x 30	4,4
IK 125-0401	IK 126-0401	4 7 x 7	M4 x 60	4,4
IK 125-0500	IK 126-0500	5 7 x 7	M5 x 30	5,5
IK 125-0501	IK 126-0501	5 7 x 7	M5 x 60	5,5
IK 125-0600	IK 126-0600	6 7 x 7	M6 x 30	6,6
IK 125-0601	IK 126-0601	6 7 x 7	M6 x 60	6,6
IK 125-0800	IK 126-0800	8 7 x 7	M8 x 30	8,8
IK 125-0801	IK 126-0801	8 7 x 7	M8 x 60	8,8



Both sides turnbuckle with external thread F30 hammered

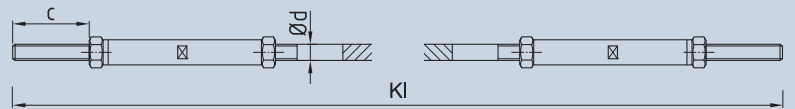

Part number both sides RH thread	Ø rope Sk	Thread size x length c	Adjustment	Ø d ±0,2
IK 130-0400	4 7 x 7	M5 x 60	+60 -90	4,9
IK 130-0500	5 7 x 7	M6 x 60	+74 -110	5,9
IK 130-0600	6 7 x 7	M8 x 60	+74 -110	7,9



Both sides external thread swageless connection

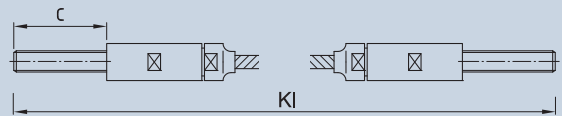

Part number both sides RH thread	Part number one LH thread one RH thread	Ø rope Sk	Thread size x length c
IK 140-0200	IK 141-0200	2 7 x 7	M6 x 30
IK 140-0201	IK 141-0201	2 7 x 7	M6 x 60
IK 140-0300	IK 141-0300	3 7 x 7	M6 x 30
IK 140-0301	IK 141-0301	3 7 x 7	M6 x 60
IK 140-0400	IK 141-0400	4 7 x 7	M6 x 30
IK 140-0401	IK 141-0401	4 7 x 7	M6 x 60
IK 140-0500	IK 141-0500	5 7 x 7	M8 x 30
IK 140-0501	IK 141-0501	5 7 x 7	M8 x 60
IK 140-0600	IK 141-0600	6 7 x 7	M8 x 30
IK 140-0601	IK 141-0601	6 7 x 7	M8 x 60
IK 140-0800	IK 141-0800	8 7 x 7	M10 x 80
IK 140-1000	IK 141-1000	10 7 x 19	M14 x 100
IK 140-1200	IK 141-1200	12 7 x 19	M16 x 120



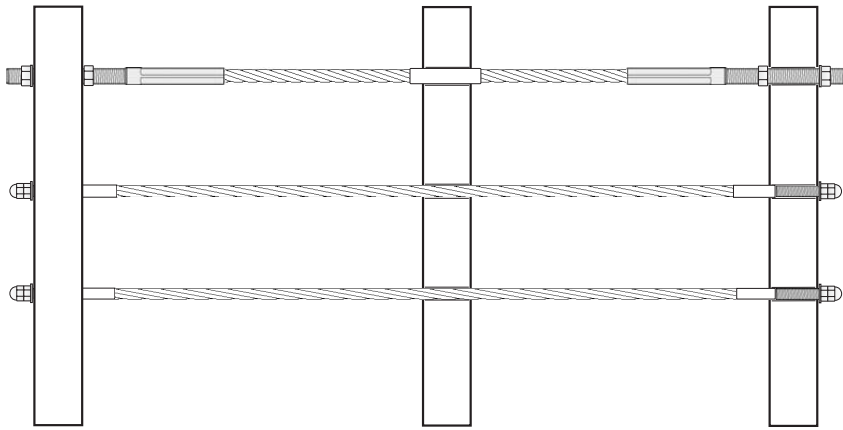

Tension is created within the cable by tightening the nuts. Loose sleeves serve to protect the cables and coated post profiles against abrasion.

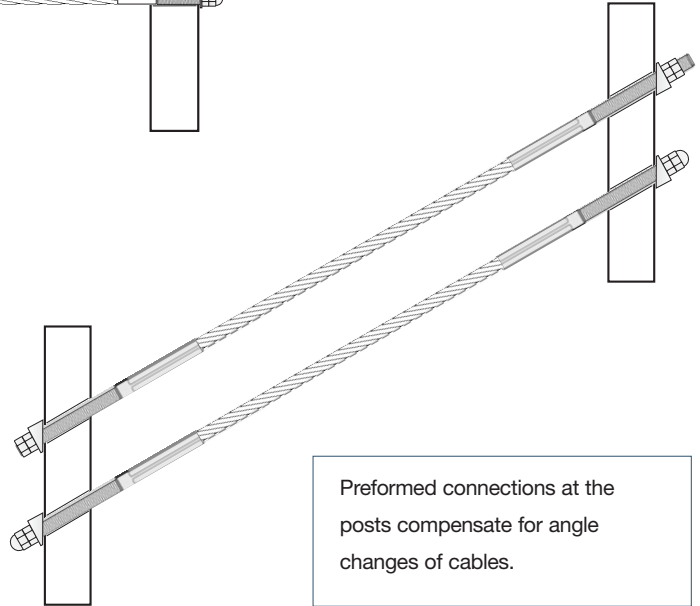

Preformed connections at the posts compensate for angle changes of cables.

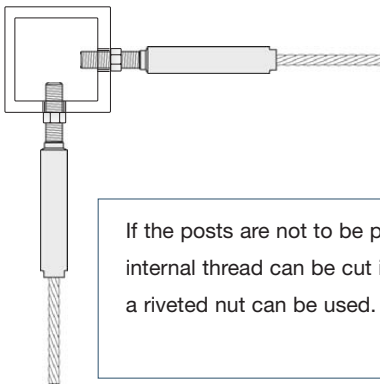

If the posts are not to be penetrated, an internal thread can be cut in the wall or a riveted nut can be used.

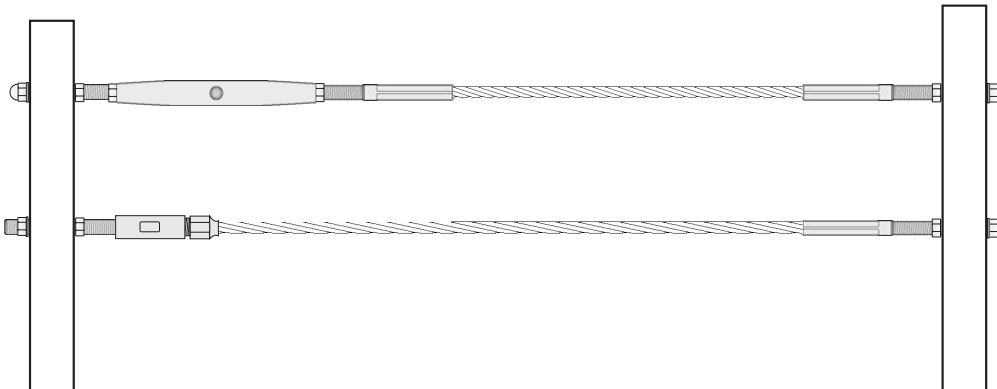
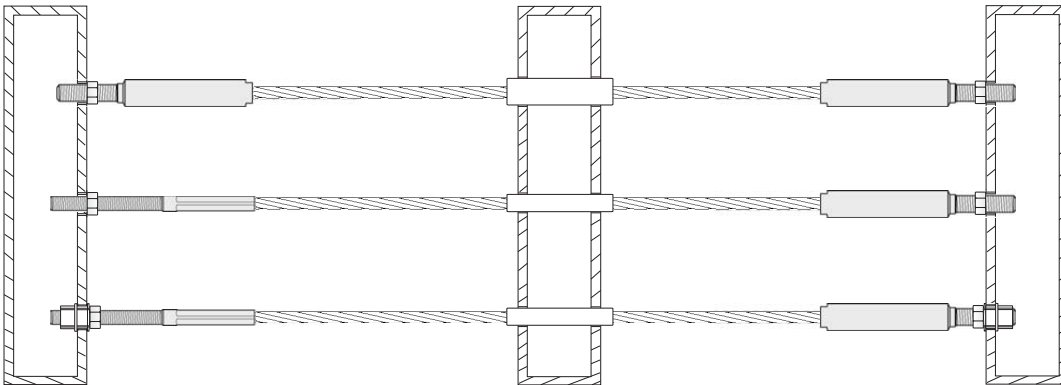

Compensation for large tolerances allows use of ready assembled parts with turnbuckles and end connections for self assembly.



I-SYS: Internal Threads



Long lengths of splendid cable can be seen in bridges and on stairways. They provide safety, divide different areas of use from one another or mark structures in public spaces. Generous forms require the cables to be strung in the right rhythm. Internal threads do sterling service here. Reduced to a minimum as regards form, they secure the cable fixing, maintain cables at the right lengths and keep them parallel to one another.



Internal thread swaged

Part number RH thread	Part number LH thread	ø rope	a	b	c	ø d	kN
860-0200-015	861-0200-015	2	M4	45	15	6	2,9
860-0300-020	861-0300-020	3	M5	60	20	7	6,7
860-0300-035	861-0300-035	3	M5	90	35	7	6,7
860-0400-020	861-0400-020	4	M6	65	20	8	11,8
860-0400-035	861-0400-035	4	M6	90	35	8	11,8
860-0500-020	861-0500-020	5	M6	70	20	8	12
860-0500-035	861-0500-035	5	M6	100	35	8	12
860-0600-025	861-0600-025	6	M8	90	25	10	16,5
860-0600-050	861-0600-050	6	M8	120	50	10	16,5
860-0800-060	861-0800-060	8	M10	180	60	13	26
860-1000-080	861-1000-080	10	M12	170	80	18	69,5
860-1000-081	861-1000-081	10	M14	185	80	20	69,5
860-1200-100	861-1200-100	12	M16	210	100	24	93,6
860-1600-120	861-1600-120	16	M20	250	120	30	159

Material 1.4404

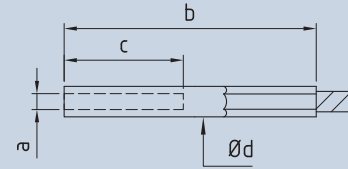

Internal thread swivel swaged

Part number	ø rope	a	b	c	ø d1	ø d2	kN
857-0300-020	3	M5	91	20	10	8	4,6
857-0300-035	3	M5	113	35	10	8	4,6
857-0400-020	4	M6	91	20	10	8	8,1
857-0400-035	4	M6	113	35	10	8	8,1
857-0500-020	5	M6	111	20	13	10	12
857-0500-035	5	M6	133	35	13	10	12
857-0600-025	6	M8	116	25	13	10	12,5
857-0600-050	6	M8	148	50	13	10	12,5

Material 1.4404 | Not suitable for strand 1 x 19

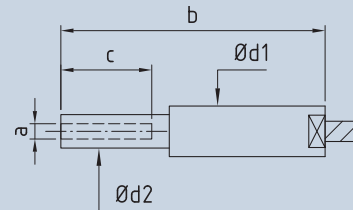

Internal thread swageless connection

Part number RH thread	Part number LH thread	ø rope	a	b	c	ø d	kN
831-0200	832-0200	2	M6	55	18	13	2
831-0300	832-0300	3	M6	55	18	13	4,5
831-0400	832-0400	4	M6	55	18	13	8
831-0500	832-0500	5	M8	57	20	15	12,6
831-0600	832-0600	6	M8	57	20	15	18,1
831-0800	832-0800	8	M10	87	40	20	32,2
831-1000	832-1000	10	M14	123	60	28	46,8
831-1200	832-1200	12	M16	137	60	30	67,6

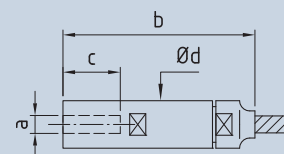

Material 1.4404 | Not suitable for strand 1 x 19

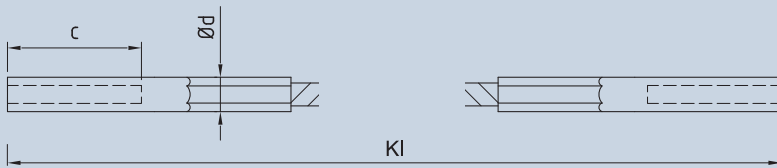
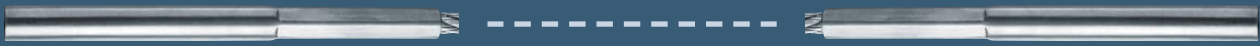

Both sides internal thread swaged

Part number both sides RH thread	Part number one LH thread one RH thread	\varnothing rope Sk	Thread size x length c	\varnothing d
IK 200-0200	IK 201-0200	2 7 x 7	M4 x 15	6
IK 200-0300	IK 201-0300	3 7 x 7	M5 x 20	7
IK 200-0301	IK 201-0301	3 7 x 7	M5 x 35	7
IK 200-0400	IK 201-0400	4 7 x 7	M6 x 20	8
IK 200-0401	IK 201-0401	4 7 x 7	M6 x 35	8
IK 200-0500	IK 201-0500	5 7 x 7	M6 x 20	8
IK 200-0501	IK 201-0501	5 7 x 7	M6 x 35	8
IK 200-0600	IK 201-0600	6 7 x 7	M8 x 25	10
IK 200-0601	IK 201-0601	6 7 x 7	M8 x 50	10
IK 200-0800	IK 201-0800	8 7 x 7	M10 x 60	13
IK 200-1000	IK 201-1000	10 7 x 19	M12 x 80	18
IK 200-1200	IK 201-1200	12 7 x 19	M16 x 100	24
IK 200-1600	IK 201-1600	16 7 x 19	M20 x 120	30

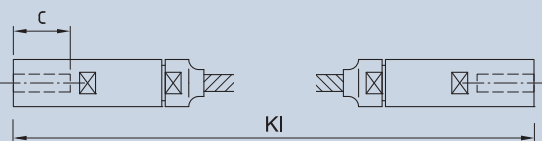

Both sides internal thread swageless connection

Part number both sides RH thread	Part number one LH thread one RH thread	\varnothing rope Sk	Thread size x length c
IK 210-0200	IK 211-0200	2 7 x 7	M6 x 18
IK 210-0300	IK 211-0300	3 7 x 7	M6 x 18
IK 210-0400	IK 211-0400	4 7 x 7	M6 x 18
IK 210-0500	IK 211-0500	5 7 x 7	M8 x 20
IK 210-0600	IK 211-0600	6 7 x 7	M8 x 20
IK 210-0800	IK 211-0800	8 7 x 7	M10 x 40
IK 210-1000	IK 211-1000	10 7 x 19	M14 x 60
IK 210-1200	IK 211-1200	12 7 x 19	M16 x 60



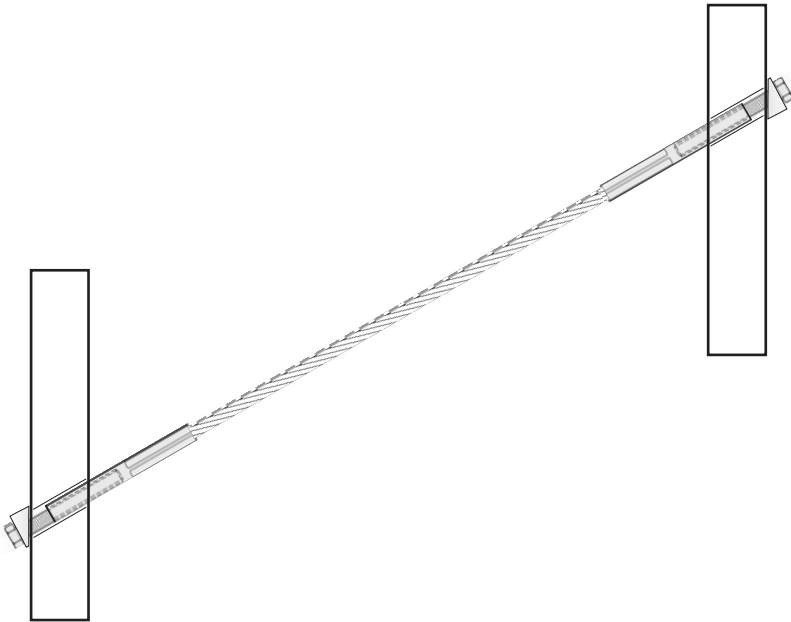

Preformed connections at the posts compensate for the angle changes.

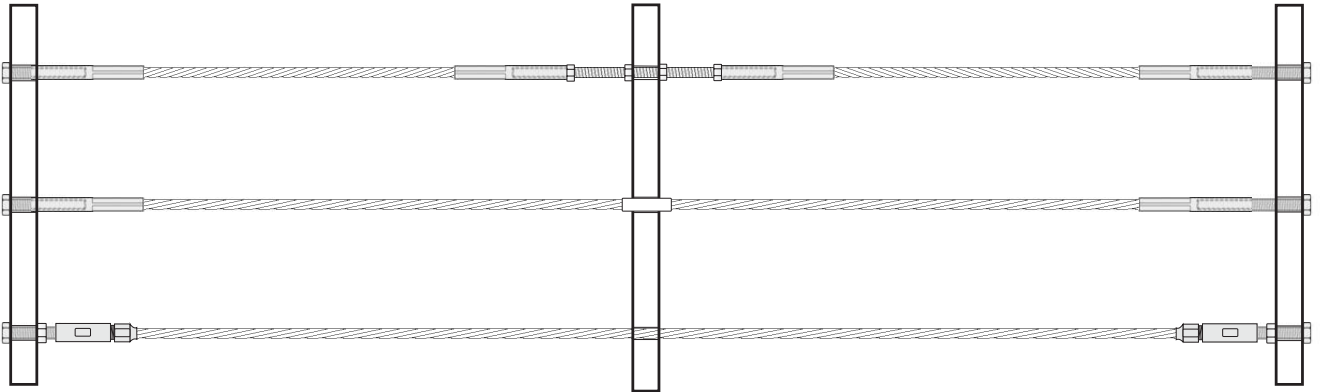

A cable stop with internal thread at the post fixes the cable up to 10 metres each in length (top). Loose sleeves protect the cable and finish of the post (centre). Tensioning at the end posts is sufficient for short lengths (below).

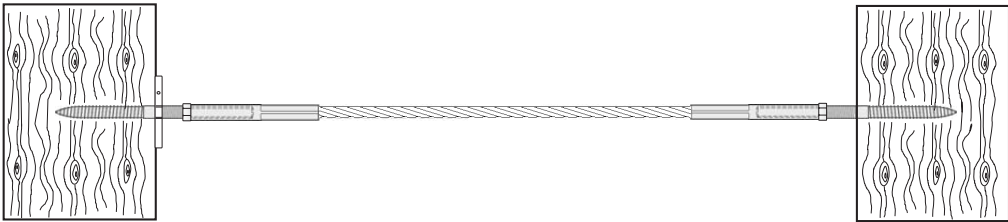

I-SYS accessories are available for fixing cable assemblies with internal thread to the different bases.

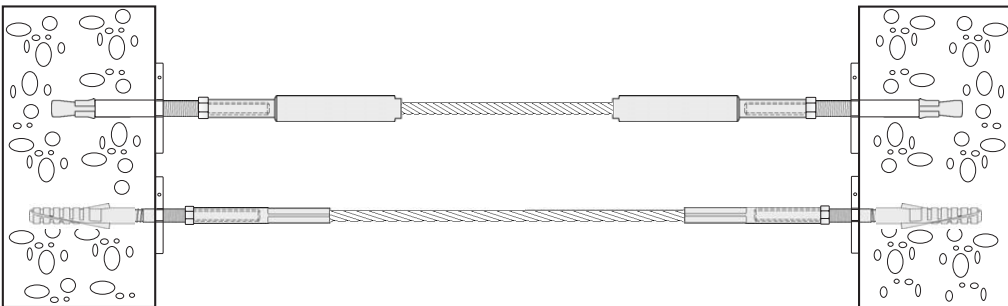







I-SYS: Forks

Slim and elegant, but strong and long lived: these are the requirements placed on connections between cable and building. Intelligent design is absolutely essential. The I-SYS range impresses with its unique aesthetic qualities. Refined technical processing of the stainless steel in conjunction with organic forms are typical of CS-Forks and CS-Eyes. The international jury of the leading architectural journal AIT awarded the range the highly-regarded „Innovation Prize for Architecture and Construction“, recognising the new elegance of these industrial elements.



CS-Fork with external thread

Part number RH thread	Part number LH thread	a	b	c	ød	e	f	g	h
945-0600	946-0600	M6	77	35	6	7,5	14	6,5	20
945-0800	946-0800	M8	77	35	6	7,5	14	6,5	20
945-0801	946-0801	M8	106	50	8	10	19	8,5	24
945-1000	946-1000	M10	106	50	8	10	19	8,5	24

Material 1.4401 | CS-Fork is compatible with CS-Eye

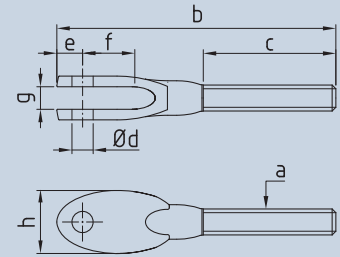

Fork with external thread

Part number RH thread	Part number LH thread	a	b	c	ød	e	f	g	h
871-0500-01	872-0500-01	M5	55	30	5	6	12	7,5	12,5
871-0500	872-0500	M5	66	41	5	6	12	7,5	12,5
871-0600-01	872-0600-01	M6	56	30	5	6	12	7,5	12,5
871-0600	872-0600	M6	73	47	5	6	12	7,5	12,5
871-0800-01	872-0800-01	M8	64	35	6	7	13	10	14,5
871-0800	872-0800	M8	86	57	6	7	13	10	14,5
871-1000	872-1000	M10	99	63	8	9	15	11	18
871-1200	872-1200	M12	133	80	12	14	25	14	26
871-1400	872-1400	M14	143	90	12	14	25	14	26
871-1600	872-1600	M16	167	100	14	18	31	22	34
871-2000	872-2000	M20	214	119	19	22	42	24	42
871-2400	872-2400	M24	286	170	25	28	50	30	50

Material 1.4401

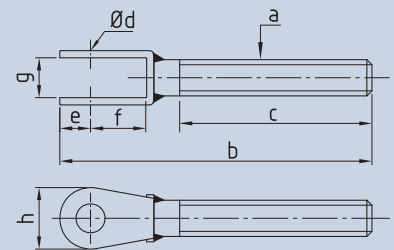

CS-Fork with internal thread

Part number RH thread	Part number LH thread	a	b	c	ød1	ød2	e	f	g	h
917-0500	918-0500	M5	78	40	6	10	7,5	14	6,5	20
917-0600	918-0600	M6	78	40	6	10	7,5	14	6,5	20
917-0800	918-0800	M8	78	40	6	10	7,5	14	6,5	20
917-0801	918-0801	M8	106	55	8	13	10	19	8,5	24
917-1000	918-1000	M10	106	55	8	13	10	19	8,5	24

Material 1.4401 | CS-Fork is compatible with CS-Eye

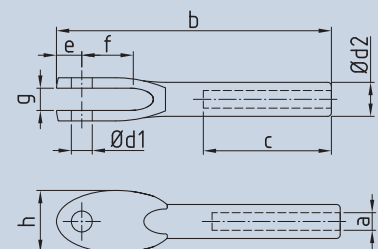



Fork with internal thread

Part number RH thread	Part number LH thread	a	b	c	ø d1	ø d2	e	f	g
817-0500	818-0500	M5	36	13	5	12	8	9	5
817-0600	818-0600	M6	43	18	6	14	9	10	6
817-0800	818-0800	M8	54	24	8	18	12	12,5	7
817-1000	818-1000	M10	69	30	10	22	15	15	8
817-1200	818-1200	M12	81	36	12	26	17	18	10
817-1600	818-1600	M16	100	40	16	34	22	22	12
817-2000	818-2000	M20	122	40	20	42	27	27	15
817-2400	818-2400	M24	150	40	22	52	34	34	18

Material 1.4401 | Fork with internal thread is compatible with eye with internal thread

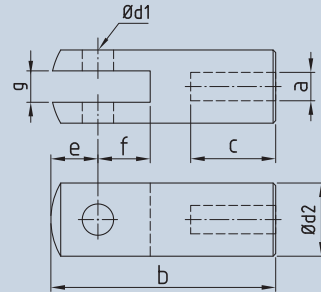

CS-Fork swaged

Part number	ø rope	b	ø d1	ø d2	e	f	g	h	kN
947-0400	4	78	6	7,8	7,5	14	6,5	20	11,8
947-0500	5	78	6	7,8	7,5	14	6,5	20	12
947-0600	6	106	8	9,8	10	19	8,5	24	16,5

Material 1.4401

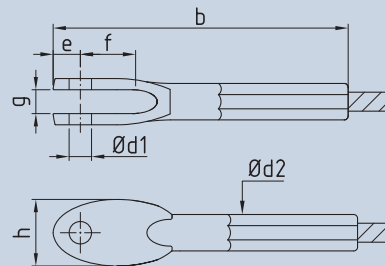



Fork swaged

Part number	ø rope	b	ø d1	ø d2	e	f	g	h	kN
881-0200	2	65	5	5,5	6	12	7,5	12,5	2,9
881-0300	3	70	5	6,3	6	12	7,5	12,5	6,6
881-0400	4	80	6	7,5	7	13	10	14,5	9,5
881-0401	4	77	5	7,5	6	12	7,5	12,5	9,5
881-0500	5	93	8	9	9	15	11	17,5	14,5
881-0501	5	87,5	6	9	7,5	13	9,5	14,5	14,5
881-0600	6	112	9,5	12,5	11	20	12	20,5	23,5
881-0601	6	106,5	8	12,5	9,5	15	11	17,5	23,5
881-0800	8	143	12	16	14	25	14	26	31,5
881-1000	10	167	14	17,8	18	31	22	34	62
881-1200	12	205	16	20	18	31	22	34	87
881-1201	12	227	19	20	22	38	24	42	87
881-1600	16	309	25,4	28	28	48	30	42	142

Material 1.4401

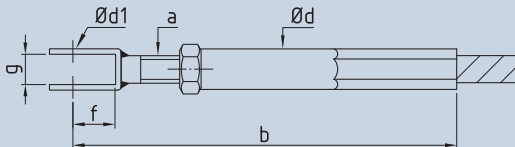
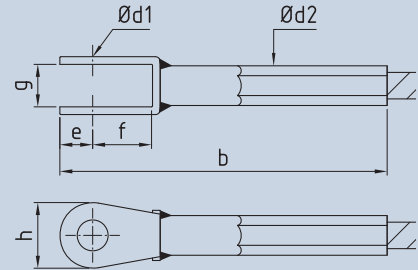

Fork with internal thread swaged

Part number RH thread	Part number LH thread	ø rope	a	b	ø d	ø d1	f	g	Adjustment	kN
812-0300-01	811-0300-01	3	M5	100	7	5	12	7,5	+5 -10	6,7
812-0300-02	811-0300-02	3	M5	136	7	5	12	7,5	+12 -17	6,7
812-0400-01	811-0400-01	4	M6	106	8	5	12	7,5	+4 -10	9,5
812-0400-02	811-0400-02	4	M6	135	8	5	12	7,5	+11 -17	9,5
812-0500-01	811-0500-01	5	M6	110	8	5	12	7,5	+4 -10	12
812-0500-02	811-0500-02	5	M6	145	8	5	12	7,5	+11 -17	12
812-0600-01	811-0600-01	6	M8	135	10	6	13	10	+4 -12	16,5
812-0600-02	811-0600-02	6	M8	173	10	6	13	10	+17 -25	16,5
812-0800-01	811-0800-01	8	M10	248	13	8	15	11	+17 -27	26
812-1000-01	811-1000-01	10	M14	295	20	12	25	14	+26 -40	62
812-1200-01	811-1200-01	12	M16	345	25	14	31	22	+26 -42	77
812-1600-01	811-1600-01	16	M20	410	32	19	42	24	+30 -50	142

Material 1.4401

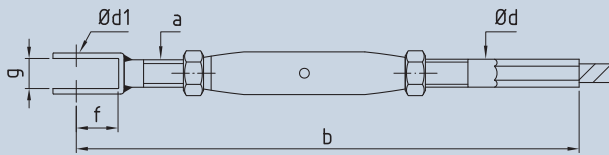
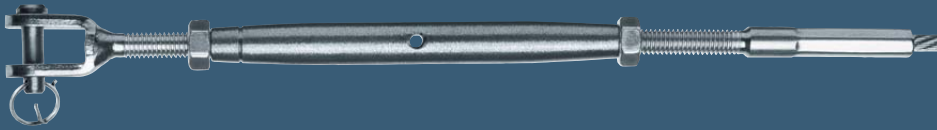

Turnbuckle with fork swaged

Part number	ø rope	a	b	ø d	ø d1	f	g	Adjustment	kN
870-0200	2	M5	190	5	5	12	7,5	+26 -43	2,9
870-0300	3	M6	220	6	5	12	7,5	+28 -50	6,6
870-0400	4	M6	225	7	5	12	7,5	+28 -50	11,5
870-0401	4	M8	248	8	6	13	10	+34 -50	11,8
870-0500	5	M8	254	8	6	13	10	+34 -50	18,5
870-0600	6	M10	283	10	8	15	11	+30 -50	26,7
870-0800	8	M12	368	13	12	25	14	+46 -70	31,5
870-1000	10	M16	490	18	14	31	22	+48 -90	69,4
870-1200	12	M20	580	20	19	42	24	+60 -105	93,6
870-1600	16	M24	680	27	25	50	30	+90 -120	158

Material 1.4401



BW-Fork swageless connection

Part number	ø rope	g	ø d	l1	l2	l3	kN
754-0300	3	6	6	55	63	11	7
754-0400	4	8	8	62	73	12	13
754-0500	5	10	10	72	83	15	20
754-0600	6	12	12	82	95	18	29
754-0800	8	14	14	103	118	21	52
754-1000	10	16	16	115	133	24	82
754-1200	12	18	19	137	157	27	118



Material 1.4401

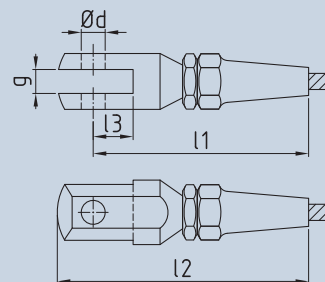



Fork roll swaged

Part number	ø rope	b	ø d	ø d1	e	f	g	h
681-0600	6	116	10	12,5	14	18	10	22
681-0800	8	151	12	16,1	16	24	12	28
681-1000	10	185	16	17,8	20	29	14	34
681-1200	12	220	20	21,4	25	35	17	41
681-1400	14	238	23	24,9	28	41	20	48
681-1600	16	286	26	28	33	48	22	54,5
681-1800	18	335	29	34,5	38	53	28	69,5
681-2200	22	379	33	43	40	61	30	72
681-2600	26	445	36	45,9	45	71	33	83

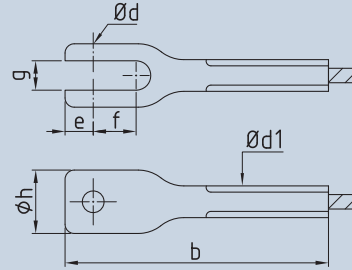

Material 1.4404 | European Technical Approval ETA-10/0358 granted

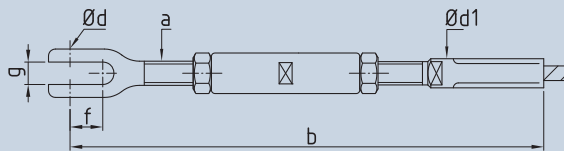

Turnbuckle with fork fitting

Part number	ø rope	a	b	e	f	g	ø d	ø d1	Adjustment
670-0600	6	M10	231	14	18	10	10	12,5	+13 -43
670-0800	8	M12	307	16	24	12	12	16,1	+22 -58
670-1000	10	M14	346	20	29	14	16	17,8	+31 -73
670-1200	12	M16	458	25	35	17	20	21,4	+39 -87
670-1400	14	M20	535	28	41	20	23	24,9	+46 -106
670-1600	16	M24	644	33	48	22	26	28	+60 -126
670-1800	18	M27	712	38	53	28	29	34,5	+54 -135
670-2200	22	M30	850	40	61	30	33	43	+74 -164
670-2600	26	M36	913	45	71	33	36	45,9	+56 -164

Material 1.4404 | European Technical Approval ETA-10/0358 granted

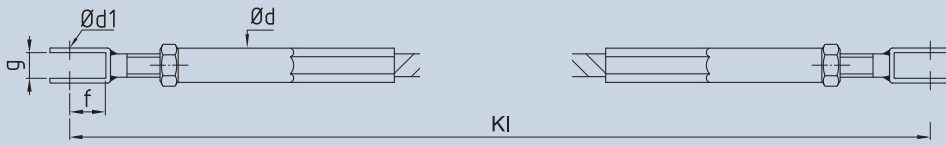

Both sides fork with internal thread swaged

Part number	ø rope Sk	Thread	Adjustment	ø d	f	g	ø d1
IK 300-0300	3 7 x 7	M5	+10 -20	7	12	7,5	5
IK 300-0301	3 7 x 7	M5	+24 -34	7	12	7,5	5
IK 300-0400	4 7 x 7	M6	+8 -20	8	12	7,5	5
IK 300-0401	4 7 x 7	M6	+22 -34	8	12	7,5	5
IK 300-0500	5 7 x 7	M6	+8 -20	8	12	7,5	5
IK 300-0501	5 7 x 7	M6	+22 -34	8	12	7,5	5
IK 300-0600	6 7 x 7	M8	+8 -24	10	13	10	6
IK 300-0601	6 7 x 7	M8	+34 -50	10	13	10	6
IK 300-0800	8 7 x 7	M10	+34 -54	13	15	11	8
IK 300-1000	10 7 x 19	M14	+52 -80	20	25	14	12
IK 300-1200	12 7 x 19	M16	+52 -84	25	31	22	14
IK 300-1600	16 7 x 19	M20	+60 -100	32	42	24	19

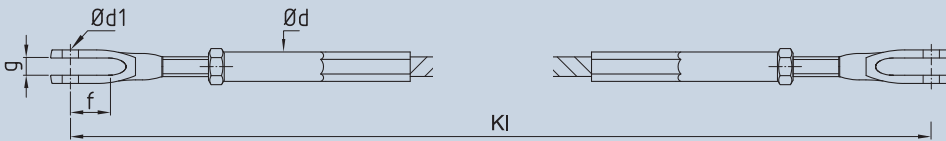

Both sides CS-Fork with internal thread swaged

Part number	ø rope Sk	Thread	Adjustment	ø d	f	g	ø d1
IK 305-0400	4 7 x 7	M6	+14 -22	8	14	6,5	6
IK 305-0500	5 7 x 7	M6	+14 -22	8	14	6,5	6
IK 305-0600	6 7 x 7	M8	+22 -42	10	19	8,5	8
IK 305-0800	8 7 x 7	M10	+22 -42	13	19	8,5	8

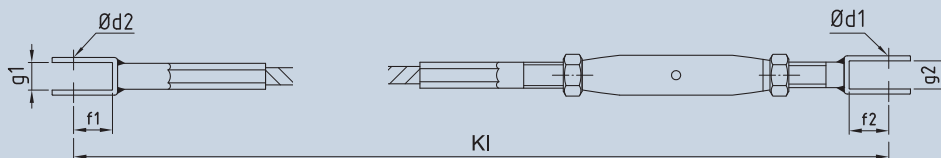

One side turnbuckle with fork, other side with fork swaged

Part number	ø rope Sk	Thread	Adjustment	f1	g1	ø d1	f2	g2	ø d2
IK 310-0200	2 7 x 7	M5	+26 -43	12	7,5	5	12	7,5	5
IK 310-0300	3 7 x 7	M6	+28 -50	12	7,5	5	12	7,5	5
IK 310-0400	4 7 x 7	M6	+28 -50	13	10	5	12	7,5	5
IK 310-0401	4 7 x 7	M8	+34 -50	13	10	6	13	10	6
IK 310-0500	5 7 x 7	M8	+34 -50	15	11	6	13	10	6
IK 310-0600	6 7 x 7	M10	+30 -50	15	11	8	15	8	8
IK 310-0800	8 7 x 7	M12	+46 -70	25	14	12	25	14	12
IK 310-1000	10 7 x 19	M16	+48 -90	31	22	14	31	22	14
IK 310-1200	12 7 x 19	M20	+60 -105	31	22	19	42	24	16
IK 310-1600	16 7 x 19	M24	+90 -120	42	30	25	42	30	25,4

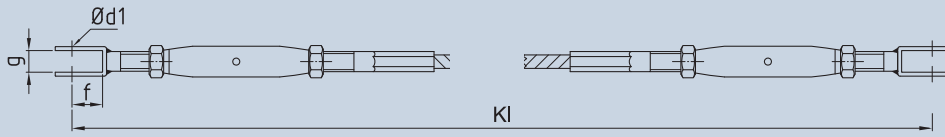

Both sides turnbuckle with fork swaged

Part number	\varnothing rope	Sk	Thread	Adjustment	$\varnothing d1$	f	g
IK 320-0200	2	7 x 7	M5	+52 -86	5	12	7,5
IK 320-0300	3	7 x 7	M6	+56 -100	5	12	7,5
IK 320-0400	4	7 x 7	M6	+56 -100	5	12	7,5
IK 320-0401	4	7 x 7	M8	+68 -100	6	13	10
IK 320-0500	5	7 x 7	M8	+68 -100	6	13	10
IK 320-0600	6	7 x 7	M10	+60 -100	8	15	11
IK 320-0800	8	7 x 7	M12	+92 -140	12	25	14
IK 320-1000	10	7 x 19	M16	+96 -180	14	32	22
IK 320-1200	12	7 x 19	M20	+120 -210	19	42	24
IK 320-1600	16	7 x 19	M24	+180 -240	25	42	25,4



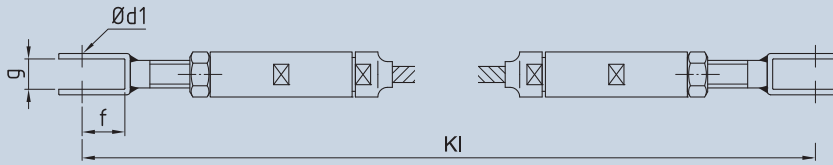

Both sides fork with internal thread swageless connection

Part number	ø rope	Sk	Thread	Adjustment	ø d1	f	g
IK 330-0200	2	7 x 7	M6	+8 -20	5	12	7,5
IK 330-0300	3	7 x 7	M6	+8 -20	5	12	7,5
IK 330-0400	4	7 x 7	M6	+8 -20	5	12	7,5
IK 330-0500	5	7 x 7	M8	+8 -20	6	13	10
IK 330-0600	6	7 x 7	M8	+8 -20	6	13	10
IK 330-0800	8	7 x 7	M10	+10 -40	8	15	11
IK 330-1000	10	7 x 19	M14	+30 -60	12	25	14
IK 330-1200	12	7 x 19	M16	+30 -60	14	31	22

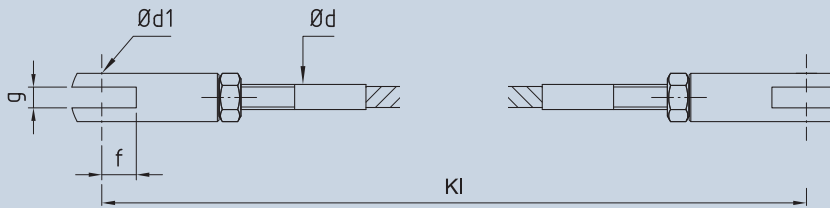

Both sides with external thread F30 complete with fork with internal thread

Part number	ø rope	Sk	Thread	Adjustment	ø d	f	g	ø d1
IK 340-0400	4	7 x 7	M5	+6 -14	4,9	9	5	5
IK 340-0500	5	7 x 7	M6	+6 -18	5,9	10	6	6
IK 340-0600	6	7 x 7	M8	+8 -30	7,9	12,5	7	8
IK 340-0800	8	7 x 7	M10	+10 -44	9,9	15	8	10
IK 340-1000	10	7 x 19	M12	+16 -40	11,9	18	10	12

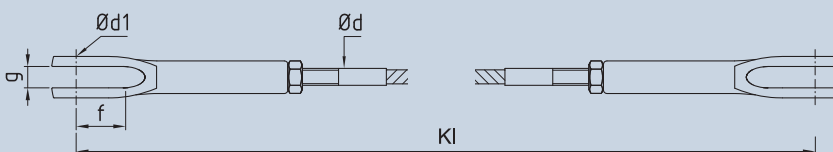

Both sides with external thread F30 complete with CS-Fork with internal thread

Part number	ø rope	Sk	Thread	Adjustment	ø d	f	g	ø d1
IK 345-0400	4	7 x 7	M5	+29 -34	4,9	14	6,5	6
IK 345-0500	5	7 x 7	M6	+29 -34	5,9	14	6,5	6
IK 345-0600	6	7 x 7	M8	+30 -49	7,9	19	8,5	8
IK 345-0800	8	7 x 7	M10	+30 -49	9,9	19	8,5	8

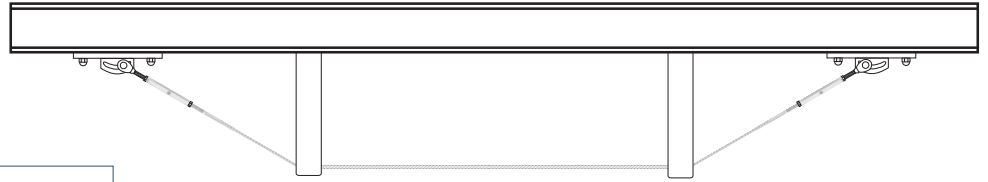

The cable assemblies with turnbuckle and forks on both sides are suitable for truss arrangements.

Cable assemblies with turnbuckle on one side are useful for bracing.

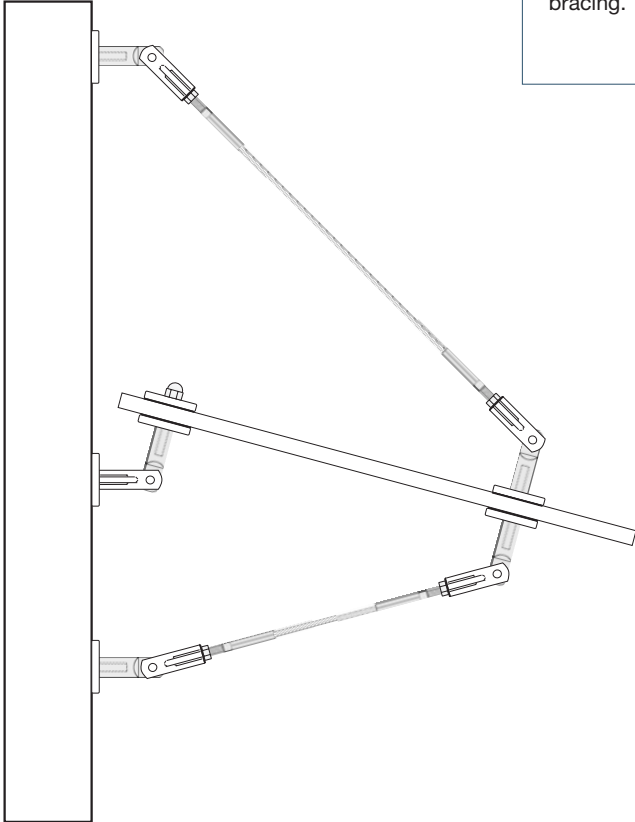
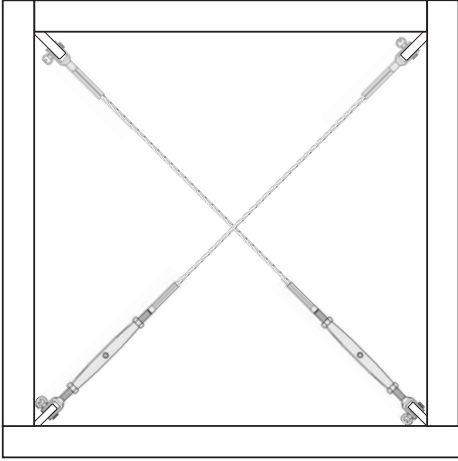

Combination of forks and eyes allow angled connections to be freely selected.

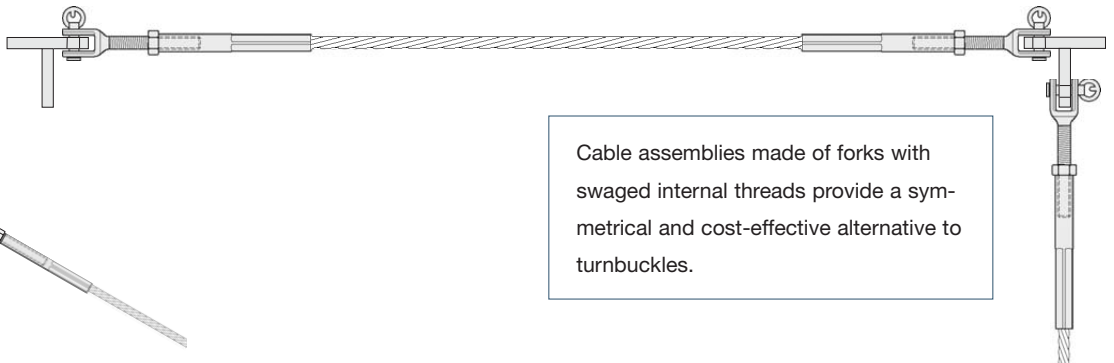

Cable assemblies made of forks with swaged internal threads provide a symmetrical and cost-effective alternative to turnbuckles.

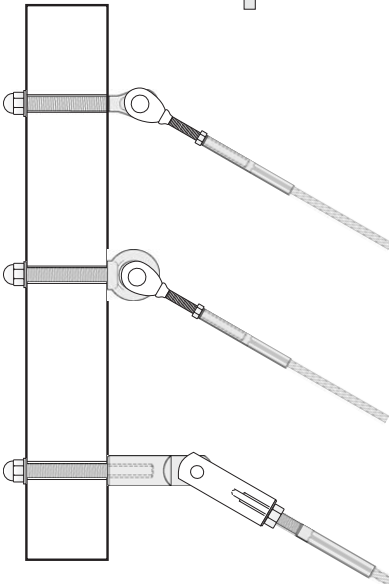

Examples for combinations with eyes and forks.





I-SYS: Eyes

As a counterpart to the forks, eyes complete the pair as regards detailed design and long lifetime. Offering a strong connection, yet also flexibly jointed, this type of coupling even goes around corners. Applied alone, eyes can also be used to guide cables or for anchorage within the shell of the building.





Eye counterpiece

Part number	a	b	c	ød1	ød2	f1	f2	g
887-0800	M8	72	48	13	5	6,5	16	5

Material 1.4401

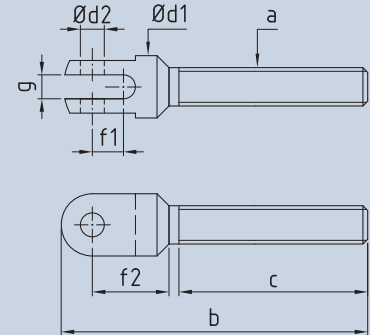

Eye with external thread

Part number RH thread	Part number LH thread	a	b	c	ød	e	f	h	k
885-0500	886-0500	M5	14	41	5,5	6	63	12	3
885-0500-01	886-0500-01	M5	15	25	5,5	6	46	12	3
885-0600	886-0600	M6	16	47	6,5	7	61	14	4
885-0600-01	886-0600-01	M6	16	30	6,5	7	44	14	4
885-0800	886-0800	M8	21	57	8,5	8,5	78	17	5
885-0800-01	886-0800-01	M8	21	35	8,5	9,5	55,5	17	5
885-1000	886-1000	M10	29	63	10,5	12	90	22	6
885-1200	886-1200	M12	31	80	13	14	110	25	8
885-1400	886-1400	M14	34	90	13	14	124	28	9
885-1600	886-1600	M16	37	100	14,5	15,5	133	31	10
885-2000	886-2000	M20	49	120	19,5	21	164	40	15

Material 1.4401

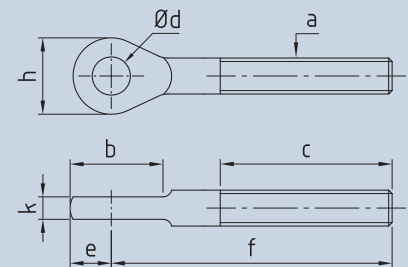

CS-Eye with external thread

Part number RH thread	Part number LH thread	a	b	c	ød	e	f	h	k
985-0600	986-0600	M6	78	32	6	8	19	20	6
985-0800	986-0800	M8	78	32	6	8	19	20	6
985-0801	986-0801	M8	106	47	8	10	23	24,5	8
985-1000	986-1000	M10	106	47	8	10	23	24,5	8

Material 1.4401 | CS-Eye is compatible with CS-Fork

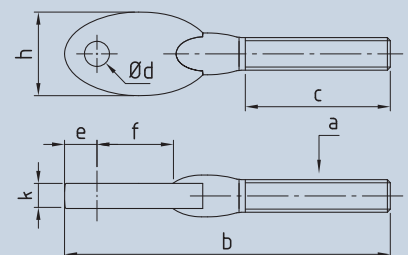



CS-Eye with internal thread

Part number RH thread	Part number LH thread	a	b	c	ø d	e	f	h	k
906-0500	907-0500	M5	78	40	6	8	19	20	6
906-0600	907-0600	M6	78	40	6	8	19	20	6
906-0800	907-0800	M8	78	40	6	8	19	20	6
906-0801	907-0801	M8	106	55	8	10	23	24,5	8
906-1000	907-1000	M10	106	55	8	10	23	24,5	8

Material 1.4401 | CS-Eye is compatible with CS-Fork

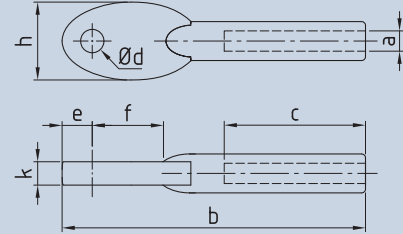

Eye with internal thread

Part number RH thread	Part number LH thread	a	b1	b2	c	ø d1	ø d2	e	f	k
806-0500	807-0500	M5	39	16	16	5	12	7	32	4,9
806-0600	807-0600	M6	46	18,5	17	6	14	8	38	5,9
806-0800	807-0800	M8	62	24,5	25	8	18	10,5	51,5	6,9
806-1000	807-1000	M10	74	30	30	10	22	13	61	7,9
806-1200	807-1200	M12	88	35	35	12	26	15	73	9,9
806-1600	807-1600	M16	112	44	40	16	34	19	93	11,9
806-2000	807-2000	M20	140	55	40	20	42	24	116	14,9
806-2400	807-2400	M24	168	68	40	22	52	30	138	17,9

Material 1.4404

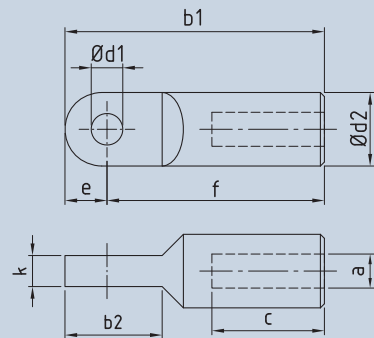

Eye bolt

Part number RH thread	Part number LH thread	a	b	c2	ø d1	ø d2	k
888-0600-03	888-0600-04	M6	40	30	6,1	14	7
888-0800-03	888-0800-04	M8	40	30	8,1	18	9
888-1000-03	888-1000-04	M10	50	40	10	20	12
888-1200-03	888-1200-04	M12	50	35	12,1	25	14
888-1600-03	888-1600-04	M16	60	40	16,1	32	17
888-2000-03	888-2000-04	M20	80	55	18,1	40	22

Material 1.4301

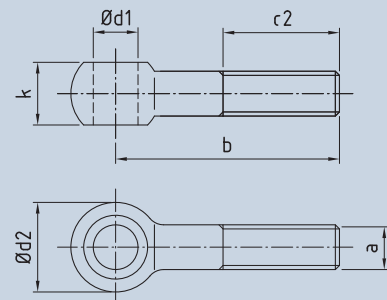

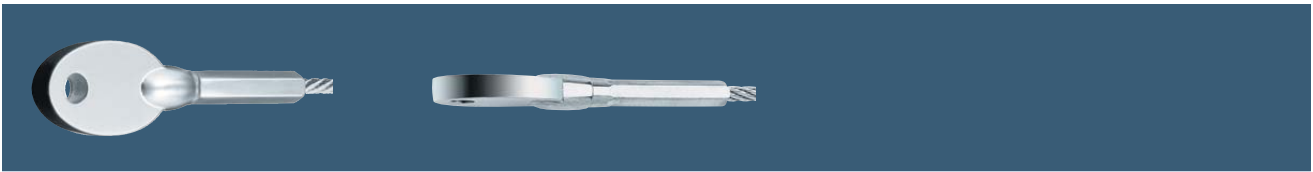

CS-Eye swaged

Part number	ø rope	b	ø d1	ø d2	e	k	f	h	kN
980-0400	4	78	7,8	6	8	6	19	20	11,8
980-0500	5	78	7,8	6	8	6	19	20	12
980-0600	6	106	9,8	8	10	8	23	24,5	16,5

Material 1.4401 | CS-Eye is compatible with CS-Fork

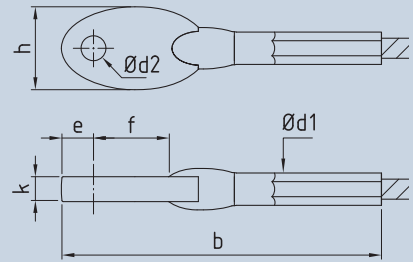

Eye swaged

Part number	ø rope	b1	b2	ø d1	ø d2	e	h	k	kN
880-0200	2	57	16	5,5	5,5	6,5	12,5	3	2,9
880-0300	3	62	17	6,3	6,5	6,5	13,5	4	6,7
880-0400	4	77	22	7,5	8,5	9	17	5	11,9
880-0500	5	87	27	9	10,5	11	21	6	18,5
880-0600	6	108	29	12,5	13	12,5	25	8	26,7
880-0800	8	133	37	16	14,5	15	30	10	44,5
880-1000	10	159	45	17,8	16,3	18	35	11	69,5
880-1200	12	181	49	20	19,3	20	40	15	93,6
880-1600	16	245	72	28,2	25,5	31,7	44	24	158,4

Material 1.4401

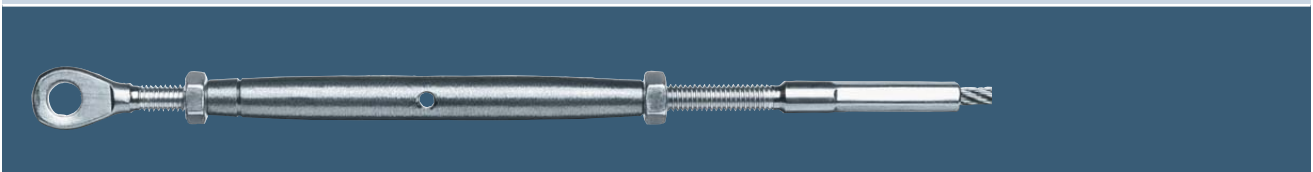
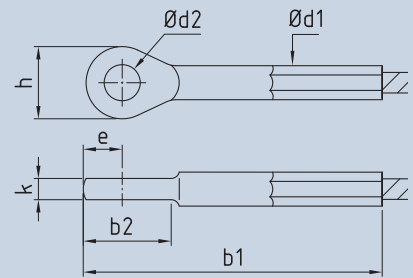

Turnbuckle with eye swaged

Part number	ø rope	a	b	ø d1	ø d2	Adjustment	kN
889-0200	2	M5	193	5	5,5	+26 -43	2,9
889-0300	3	M6	215	6	6,5	+28 -50	6,7
889-0400	4	M6	220	7	6,5	+28 -50	11,9
889-0401	4	M8	248	8	8,5	+34 -50	11,9
889-0500	5	M8	254	8	8,5	+34 -50	18,5
889-0600	6	M10	288	10	10,5	+30 -50	26,7
889-0800	8	M12	368	13	13	+46 -70	44,5
889-1000	10	M16	490	18	14,5	+48 -90	69,5
889-1200	12	M20	570	20	19,5	+60 -105	93,6

Material 1.4401

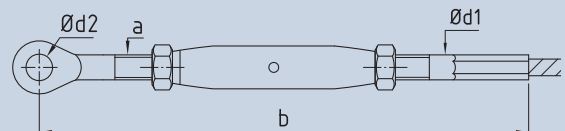

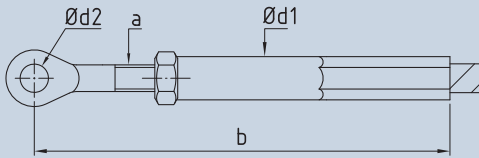

Eye with internal thread swaged

Part number RH thread	Part number LH thread	ø rope a	b	ø d1	ø d2	Adjustment	kN	
814-0300-01	813-0300-01	3	M5	100	7	5,5	+5 -10	6,7
814-0300-02	813-0300-02	3	M5	136	7	5,5	+12 -17	6,7
814-0400-01	813-0400-01	4	M6	106	8	6,5	+4 -10	11,8
814-0400-02	813-0400-02	4	M6	135	8	6,5	+11 -17	11,8
814-0500-01	813-0500-01	5	M6	110	8	6,5	+4 -10	12
814-0500-02	813-0500-02	5	M6	145	8	6,5	+11 -17	12
814-0600-01	813-0600-01	6	M8	135	10	8,5	+4 -12	16,5
814-0600-02	813-0600-02	6	M8	173	10	8,5	+17 -25	16,5
814-0800-01	813-0800-01	8	M10	248	13	10,5	+17 -27	26
814-1000-01	813-1000-01	10	M14	295	20	13	+26 -40	69,5
814-1200-01	813-1200-01	12	M16	345	25	14,5	+26 -42	93,6
814-1600-01	813-1600-01	16	M20	410	32	19,3	+30 -50	159

Material 1.4401





BW-Eye swageless connection

Part number	ø rope k		ø d	l1	l2	kN
753-0300	3	5,5	6,3	58	50	7
753-0400	4	7	8,3	68	58	13
753-0500	5	8	10,3	81	70	20
753-0600	6	9	12,3	97	83	29
753-0800	8	10,5	14,3	121	103	52
753-1000	10	13	16,3	133	114	82
753-1200	12	15	19,5	155	132	118

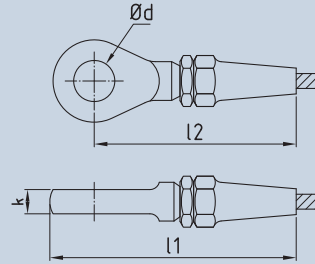

Material 1.4401

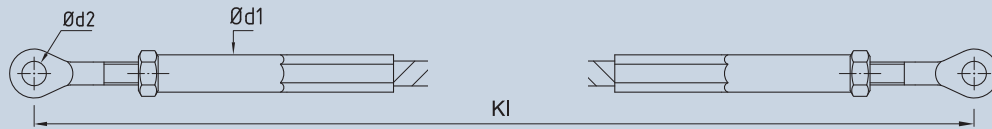
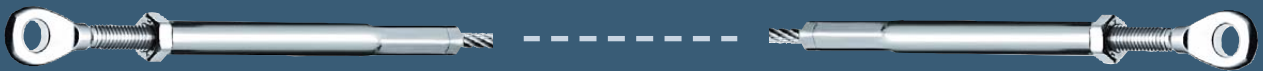

Both sides eye with internal thread swaged

Part number	ø rope Sk		Thread	Adjustment		ø d1	ø d2
IK 400-0300	3	7 x 7	M5	+10	-20	7	5,5
IK 400-0301	3	7 x 7	M5	+24	-34	7	5,5
IK 400-0400	4	7 x 7	M6	+8	-20	8	6,5
IK 400-0401	4	7 x 7	M6	+22	-34	8	6,5
IK 400-0500	5	7 x 7	M6	+8	-20	8	6,5
IK 400-0501	5	7 x 7	M6	+22	-34	8	6,5
IK 400-0600	6	7 x 7	M8	+8	-24	10	8,5
IK 400-0601	6	7 x 7	M8	+34	-50	10	8,5
IK 400-0800	8	7 x 7	M10	+34	-54	13	10,5
IK 400-1000	10	7 x 19	M14	+52	-80	20	13
IK 400-1200	12	7 x 19	M16	+52	-84	25	14,5
IK 400-1600	16	7 x 19	M20	+60	-100	32	19,3

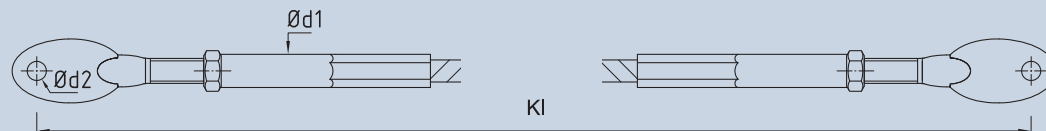

Both sides CS-Eye with internal thread swaged

Part number	ø rope Sk		Thread	Adjustment		ø d1	ø d2
IK 405-0400	4	7 x 7	M6	+14	-22	8	6
IK 405-0500	5	7 x 7	M6	+14	-22	8	6
IK 405-0600	6	7 x 7	M8	+22	-42	10	8
IK 405-0800	8	7 x 7	M10	+22	-42	13	8

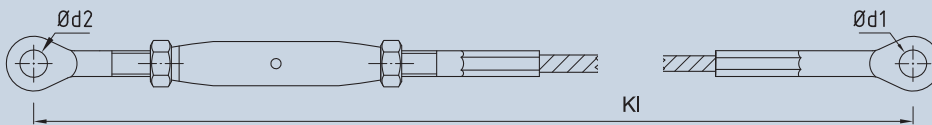

One side turnbuckle with eye, other side with eye swaged

Part number	\varnothing rope	Sk	Thread	Adjustment	$\varnothing d1$	$\varnothing d2$
IK 410-0200	2	7 x 7	M5	+26 -43	5,5	5,5
IK 410-0300	3	7 x 7	M6	+28 -50	6,5	6,5
IK 410-0400	4	7 x 7	M6	+28 -50	8,5	6,5
IK 410-0401	4	7 x 7	M8	+34 -50	8,5	8,5
IK 410-0500	5	7 x 7	M8	+34 -50	10,5	8,5
IK 410-0600	6	7 x 7	M10	+30 -50	13	10,5
IK 410-0800	8	7 x 7	M12	+46 -70	14,5	13
IK 410-1000	10	7 x 19	M16	+48 -90	16,3	14,5
IK 410-1200	12	7 x 19	M20	+60 -105	19,3	19,5

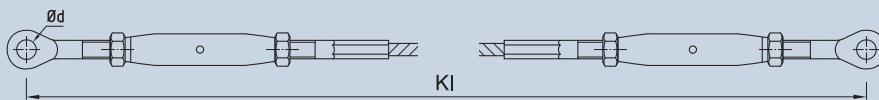

Both sides turnbuckle with eye swaged

Part number	\varnothing rope	Sk	Thread	Adjustment	$\varnothing d$
IK 420-0200	2	7 x 7	M5	+52 -86	5,5
IK 420-0300	3	7 x 7	M6	+56 -100	6,5
IK 420-0400	4	7 x 7	M6	+56 -100	6,5
IK 420-0401	4	7 x 7	M8	+68 -100	8,5
IK 420-0500	5	7 x 7	M8	+68 -100	8,5
IK 420-0600	6	7 x 7	M10	+60 -100	10,5
IK 420-0800	8	7 x 7	M12	+92 -140	13
IK 420-1000	10	7 x 19	M16	+96 -180	14,5
IK 420-1200	12	7 x 19	M20	+120 -210	19,5

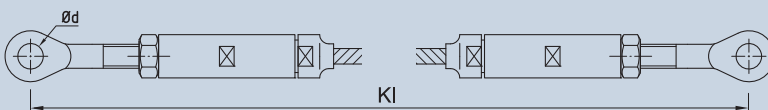

Both sides eye with internal thread swageless connection

Part number	\varnothing rope	Sk	Thread	Adjustment	$\varnothing d$
IK 430-0200	2	7 x 7	M6	+8 -20	6,5
IK 430-0300	3	7 x 7	M6	+8 -20	6,5
IK 430-0400	4	7 x 7	M6	+8 -20	6,5
IK 430-0500	5	7 x 7	M8	+8 -20	8,5
IK 430-0600	6	7 x 7	M8	+8 -20	8,5
IK 430-0800	8	7 x 7	M10	+10 -40	10,5
IK 430-1000	10	7 x 19	M14	+30 -60	13
IK 430-1200	12	7 x 19	M16	+30 -60	14,5



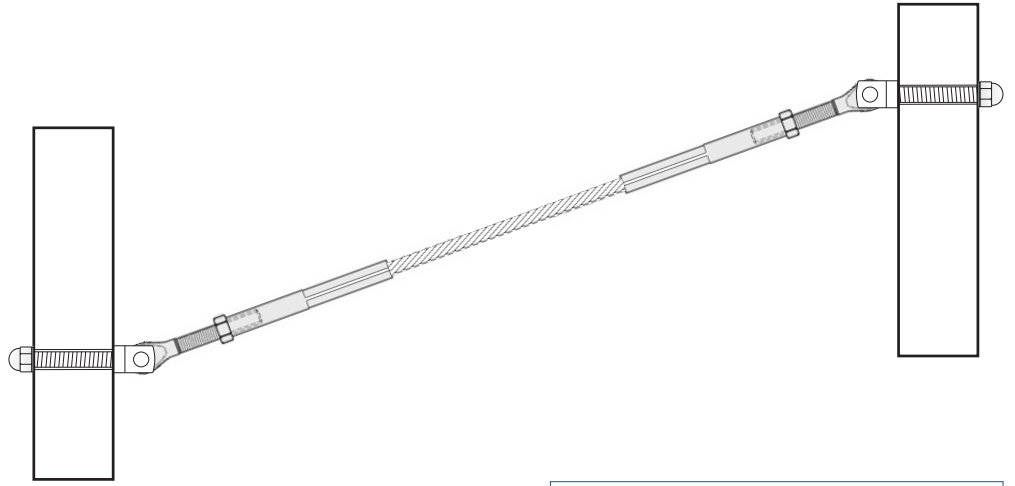

Assemblies with eye can be combined with eye counterpieces.

Eyes can be put onto a bearing cable to serve as cable connections. The position is fixed with light clamping rings.

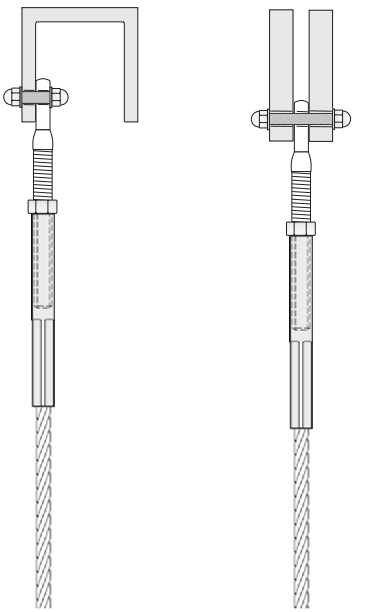
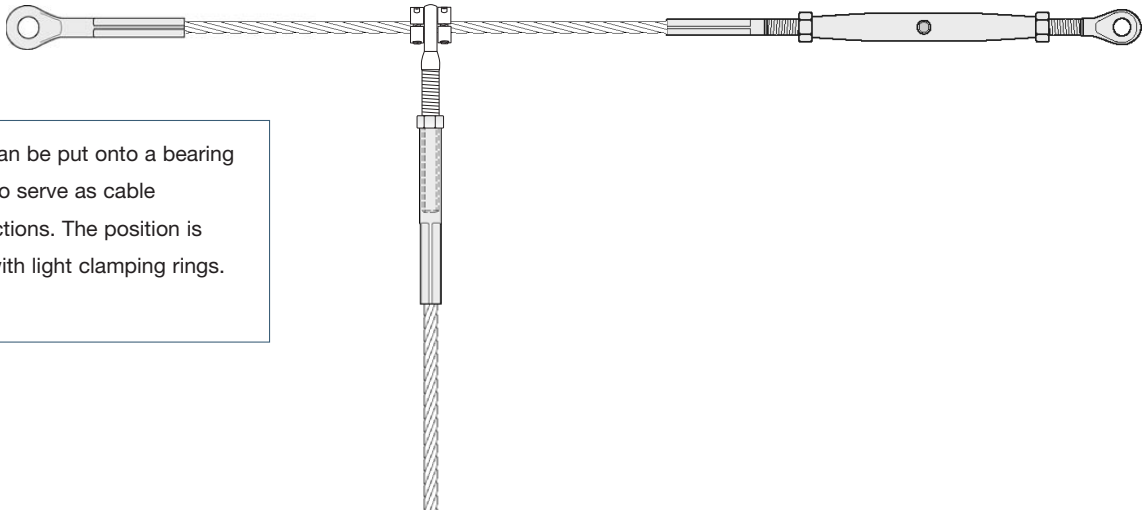

Eyes with external thread serve to guide the cable, light clamping rings distribute the tensile forces.

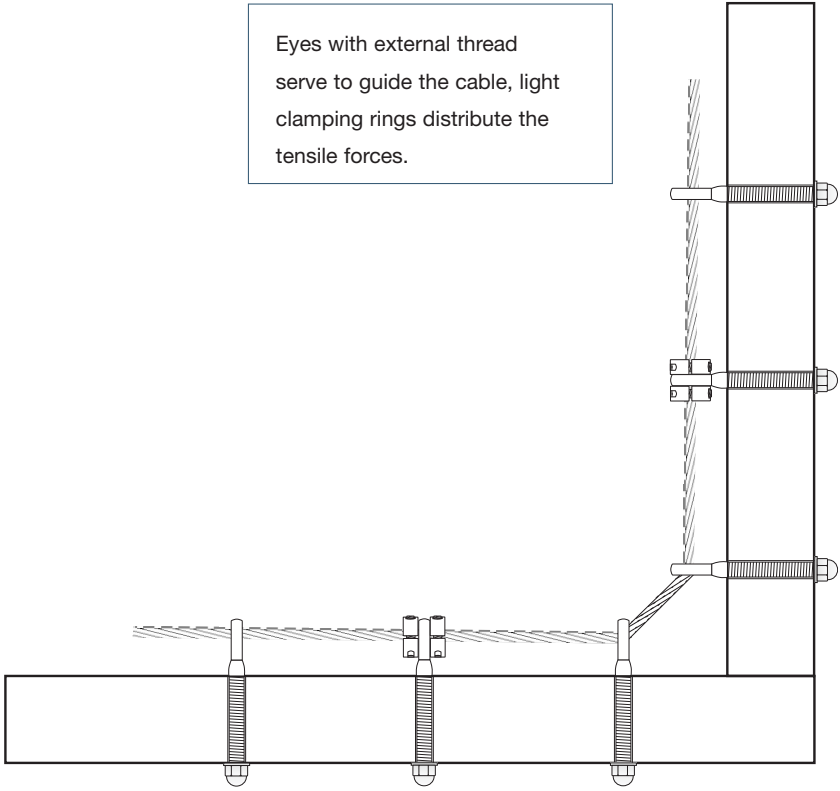

Assemblies with eyes allow connection to standard profiles.



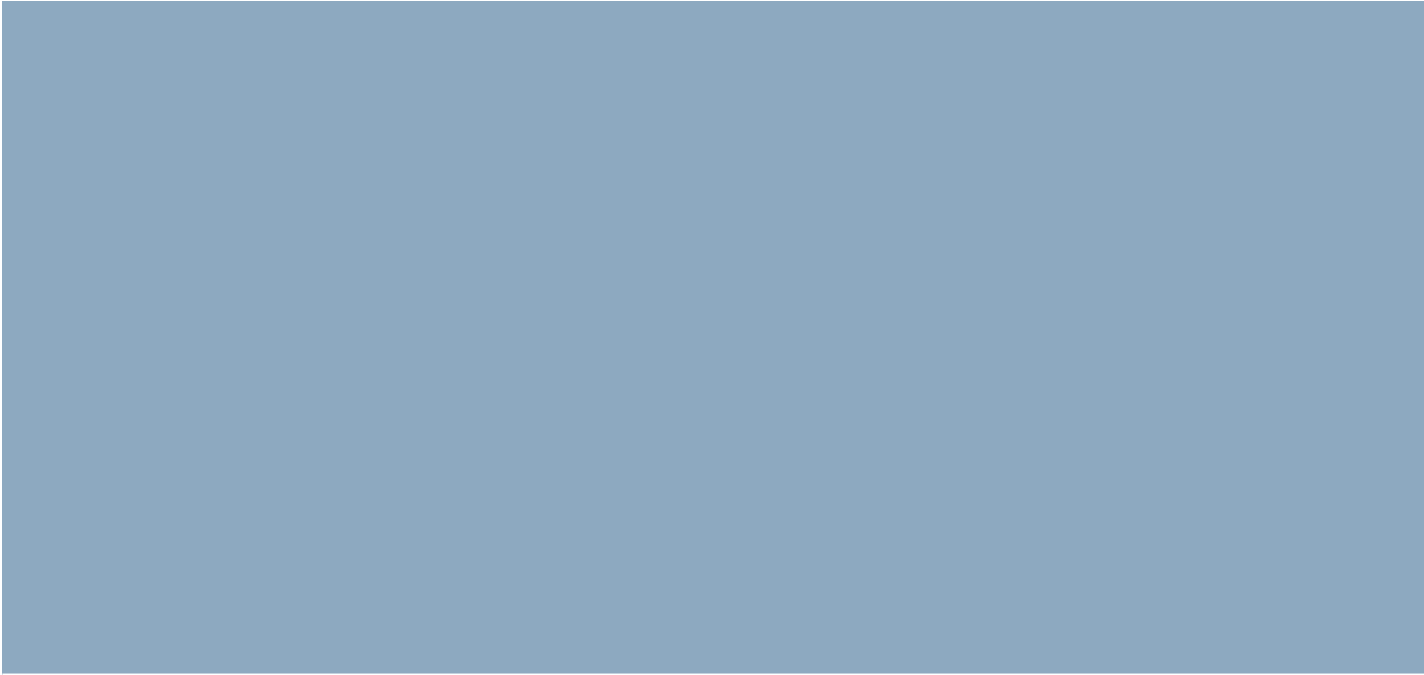



I-SYS: End Stops

End stops ensure secure fixing. Along with preformed parts they offer secure connections for sloping cable runs. Balls and sockets are also among the exceptional products offered in the I-SYS range. This rounded duo is a technical innovation for end connections at angles of slope of up to 60 degrees and is the subject of a current patent application. The principle of movement between ball and socket originates from nature: the ball sits firmly on the socket, which is round and therefore invariably fits. Rapid and formally consistent solutions which fit flexibly into the angle are the result.

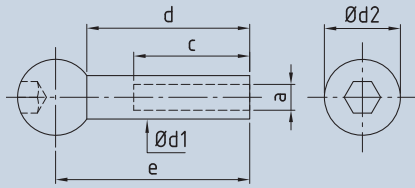

Ball head with internal thread

Part number	a	Ød1	c	d	e	Ød2
868-0400	M4	6	15	25	31,3	14
868-0500	M5	7	20	30	36	14
868-0600	M6	8	20	30	35,7	14

Material 1.4401

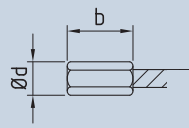

End stop swaged

Part number	Ø rope	b	Ø d	kN
865-0200	2	12	8	2
865-0300	3	15	8	4,5
865-0400	4	20	13	8,1
865-0500	5	20	13	12,6
865-0600	6	30	18	18,1
865-0800	8	40	18	23,2

Material 1.4404

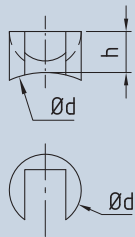

Pivot base for ball head

Part number	Ø d	h	Ø tube p
868-034	14	9,5	33,7
868-043	14	9,5	42,4
868-060	14	9,5	60

Material 1.4401 | for round profile

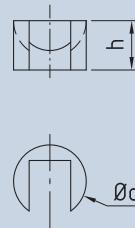

Pivot base for ball head

Part number	Ø d	h
868-456	14	9,5

Material 1.4401 | for flat profile

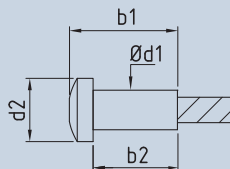

Swaged radiused head end stop

Part number	Ø rope	b1	b2	Ø d1	Ø d2	kN
869-0200	2	24	21	5	8	2,9
869-0300	3	35	31	6	10	6,7
869-0400	4	40	36	7	12	11,9
869-0500	5	47	42	8	14	18,5
869-0600	6	58	52	10	16	26,7
869-0800	8	70	62	13	22	44,5

Material 1.4404

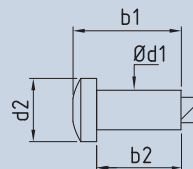

Low profile swaged radius head end stop

Part number	Ø rope	b1	b2	Ø d1	Ø d2	kN
869-0200-04	2	9,08	6,2	3	6	1,6
869-0300-04	3	10,83	9	4,5	8	3,5
869-0400-04	4	14,09	12	5	10	6,3
869-0500-04	5	19,35	16	6	12	9,8
869-0600-04	6	24,14	18	8	16	14,1
869-0800-04	8	29,51	23,5	10,2	20	25,1

Material 1.4404

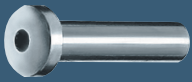

Radius head end stop with internal thread right hand

Part number	a	b1	b2	c	ø d1	ø d2
869-0400-02	M4	29	25	15	6	10
869-0500-02	M5	34	30	20	7	12
869-0600-02	M6	35	30	20	8	14
869-0800-02	M8	40	34	25	10	16

Material 1.4404

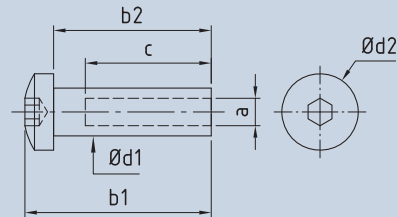

90° countersunk stop with internal thread right hand

Part number	a	b1	b2	c	ø d1	ø d2	k1	k2
866-0400-02	M4	30,2	26	15	6	10,4	2,2	2
866-0500-02	M5	33,7	30	20	7	10,4	1,7	2
866-0600-02	M6	34,2	30	20	8	12,4	2,2	2
866-0800-02	M8	40,2	37	25	10	12,4	1,2	2

Material 1.4404

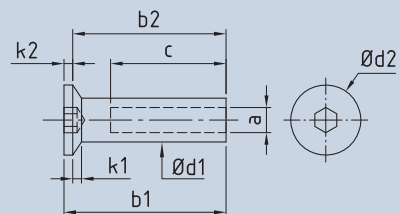

Low profile swaged radius head end stop 90°

Part number	ø rope	b1	b2	ø d1	ø d2	kN
866-0200-04	2	8,7	6,2	3	6	1,6
866-0300-04	3	10	9	4,5	8	3,5
866-0400-04	4	13,5	12	5	10	6,3
866-0500-04	5	18,3	15	6	12	9,8
866-0600-04	6	22,4	18	8	16	14,1
866-0800-04	8	27,4	23,5	10,2	20	25,1

Material 1.4404

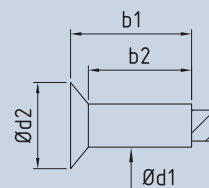

Swage end stop 90° countersunk head

Part number	ø rope	b1	b2	ø d1	ø d2	k1	k2	kN
866-0200	2	24,2	21	5	8,3	1,7	1,5	2,9
866-0300	3	35,2	31	6	10,4	2,2	2	6,7
866-0400	4	39,7	36	7	10,4	1,7	2	11,9
866-0500	5	46,2	42	8	12,4	2,2	2	18,9
866-0600	6	55,2	52	10	12,4	1,2	2	26,7
866-0800	8	68,8	62	13	20,5	3,8	3	44,5

Material 1.4404

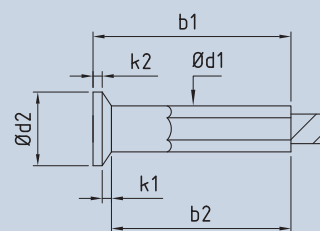

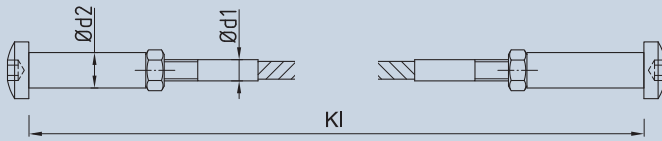
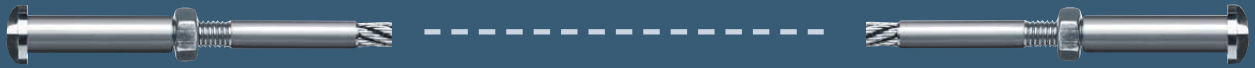

Both sides with external thread F30 and swageless-on radiused end stop

Part number	\varnothing rope	Sk	Thread	Adjustment	$\varnothing d1 \pm 0,2$	$\varnothing d2$
IK 170-0400	4	7 x 7	M5	+6 -24	4,9	7
IK 170-0500	5	7 x 7	M6	+6 -22	5,9	8
IK 170-0600	6	7 x 7	M8	+8 -26	7,9	10

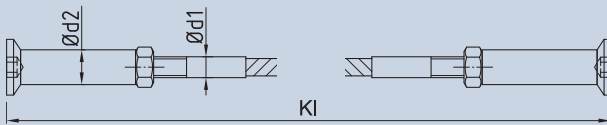

Both sides with external thread F30 and swageless-on countersunk end stops

Part number	\varnothing rope	Sk	Thread	Adjustment	$\varnothing d1 \pm 0,2$	$\varnothing d2$
IK 180-0400	4	7 x 7	M5	+6 -24	4,9	7
IK 180-0500	5	7 x 7	M6	+6 -22	5,9	8
IK 180-0600	6	7 x 7	M8	+8 -26	7,9	10

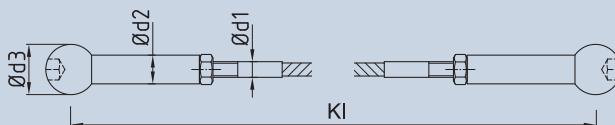

Both sides with external thread F30 and swageless-on ball head

Part number	\varnothing rope	Sk	Thread	Adjustment	$\varnothing d1 \pm 0,2$	$\varnothing d2$	$\varnothing d3$
IK 190-0300	3	7 x 7	M4	+4 -15	3,9	6	14
IK 190-0400	4	7 x 7	M5	+5 -20	4,9	7	14
IK 190-0500	5	7 x 7	M6	+5 -20	5,9	8	14

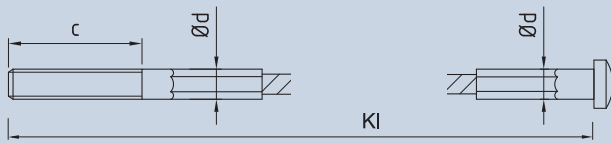
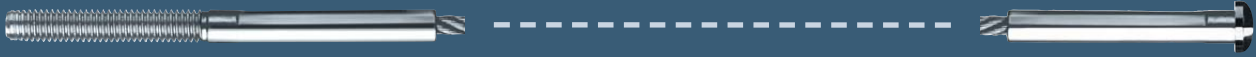

One side external thread swaged, other side radiused head end stop swaged

Part number	Ø rope	Sk	Thread size x length c	Ø d
IK 150-0200	2	7 x 7	M5 x 30	5
IK 150-0201	2	7 x 7	M5 x 60	5
IK 150-0300	3	7 x 7	M6 x 30	6
IK 150-0301	3	7 x 7	M6 x 60	6
IK 150-0400	4	7 x 7	M6 x 30	7
IK 150-0401	4	7 x 7	M6 x 60	7
IK 150-0500	5	7 x 7	M8 x 30	8
IK 150-0501	5	7 x 7	M8 x 60	8
IK 150-0600	6	7 x 7	M10 x 30	10
IK 150-0601	6	7 x 7	M10 x 60	10
IK 150-0800	8	7 x 7	M12 x 80	13

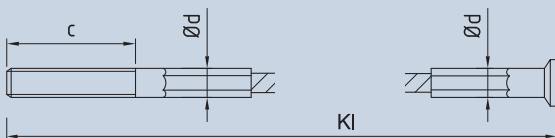

One side external thread swaged, other side countersunk end stop swaged

Part number	Ø rope	Sk	Thread size x length c	Ø d
IK 160-0200	2	7 x 7	M5 x 30	5
IK 160-0201	2	7 x 7	M5 x 60	5
IK 160-0300	3	7 x 7	M6 x 30	6
IK 160-0301	3	7 x 7	M6 x 60	6
IK 160-0400	4	7 x 7	M6 x 30	7
IK 160-0401	4	7 x 7	M6 x 60	7
IK 160-0500	5	7 x 7	M8 x 30	8
IK 160-0501	5	7 x 7	M8 x 60	8
IK 160-0600	6	7 x 7	M10 x 30	10
IK 160-0601	6	7 x 7	M10 x 60	10
IK 160-0800	8	7 x 7	M12 x 80	13

Possible connections and combinations for end stops in rectangular situations.

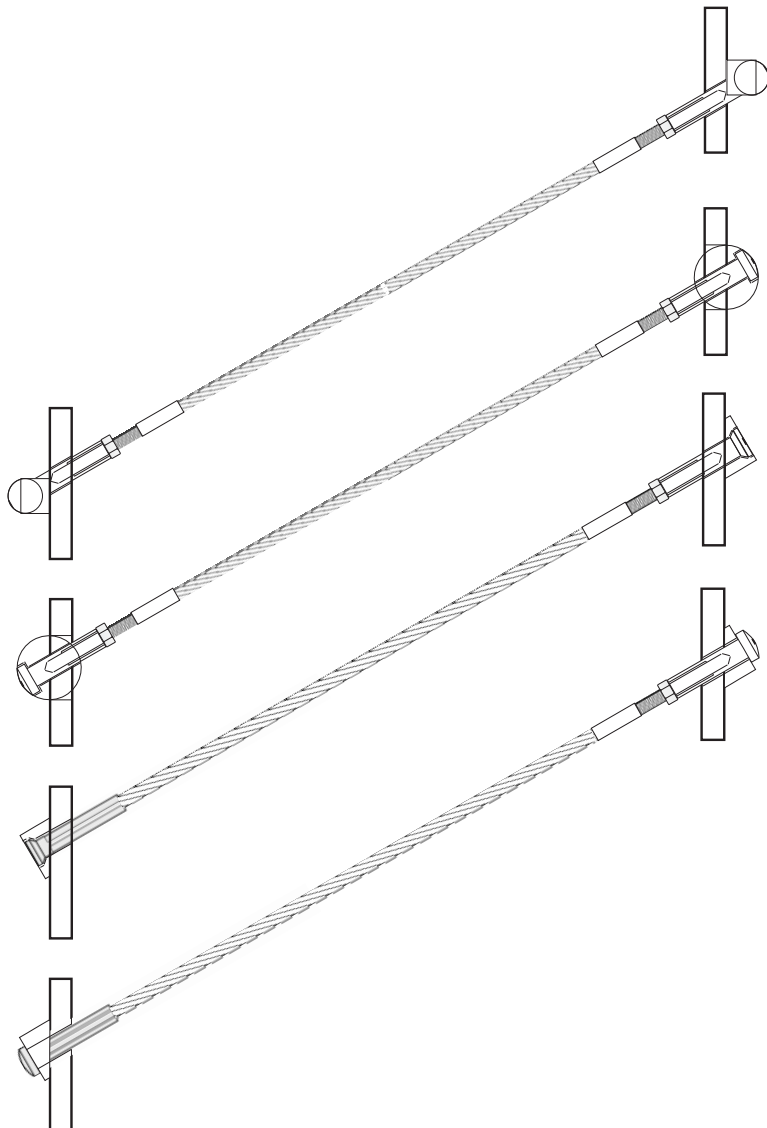
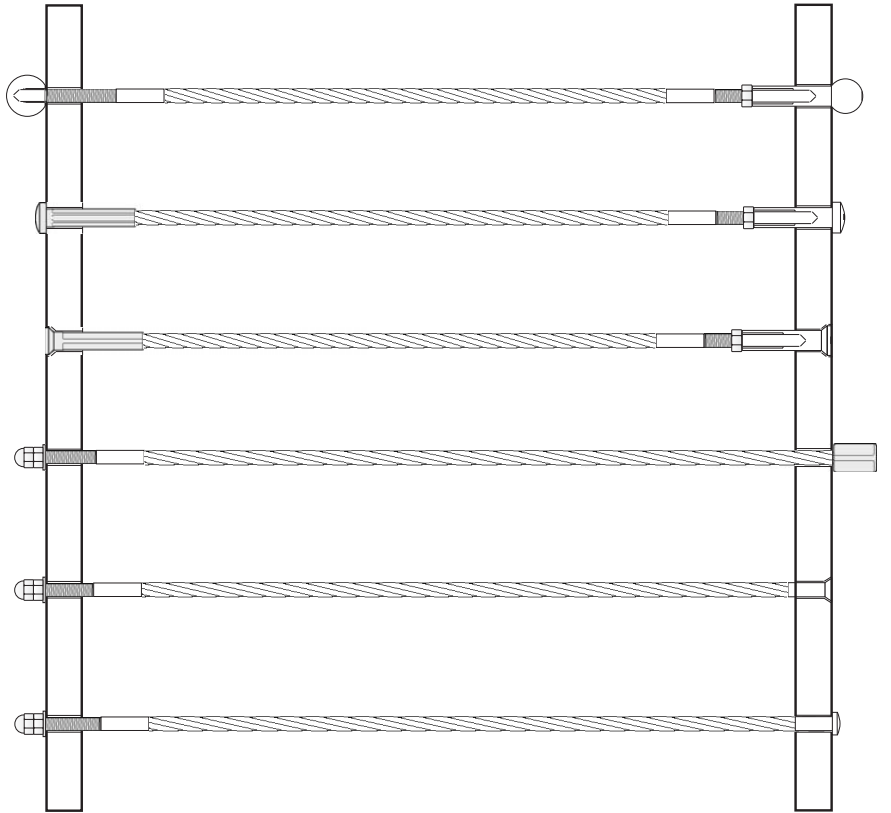

Possible connections and combinations for end stops in angled situations.

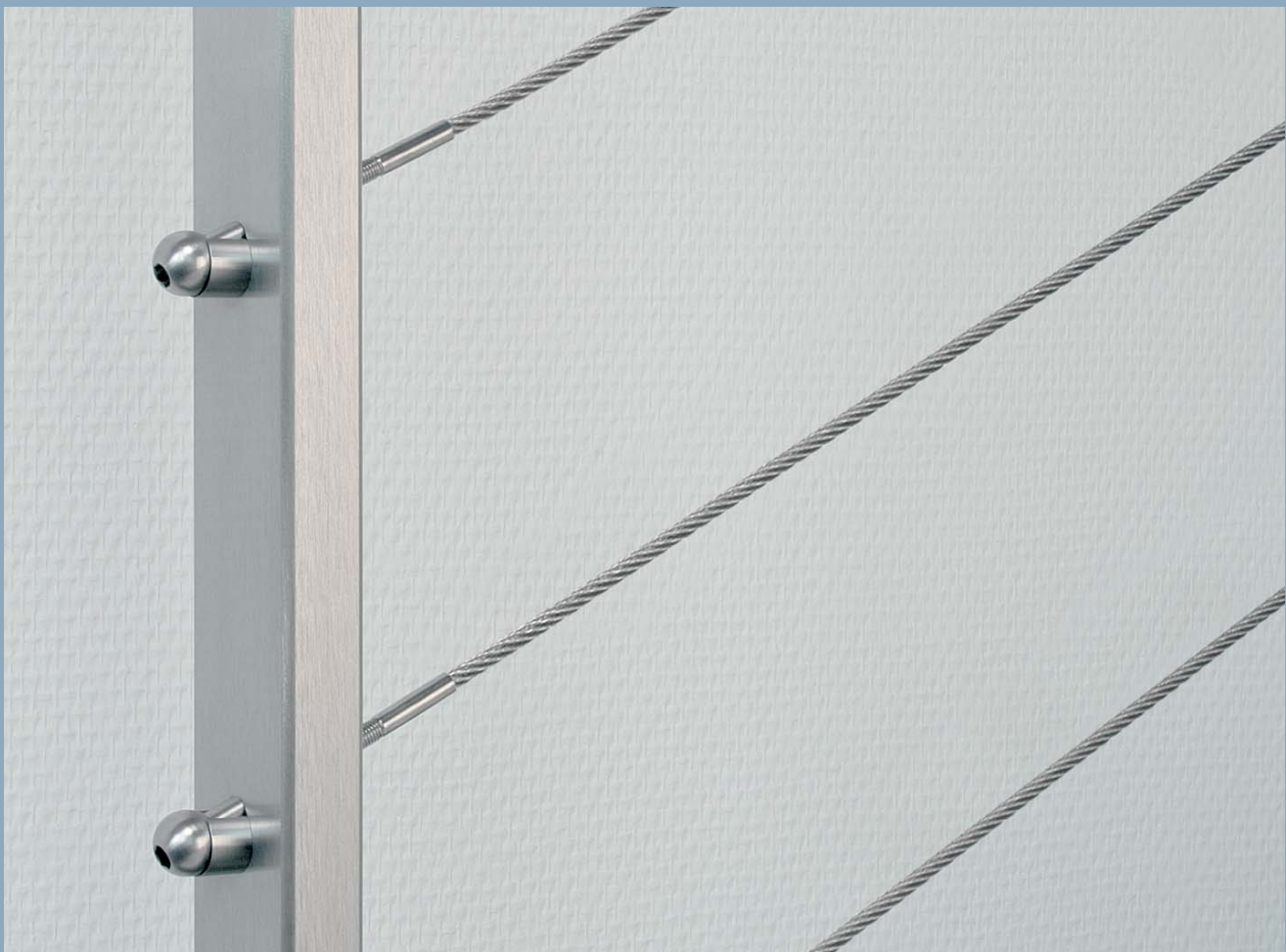

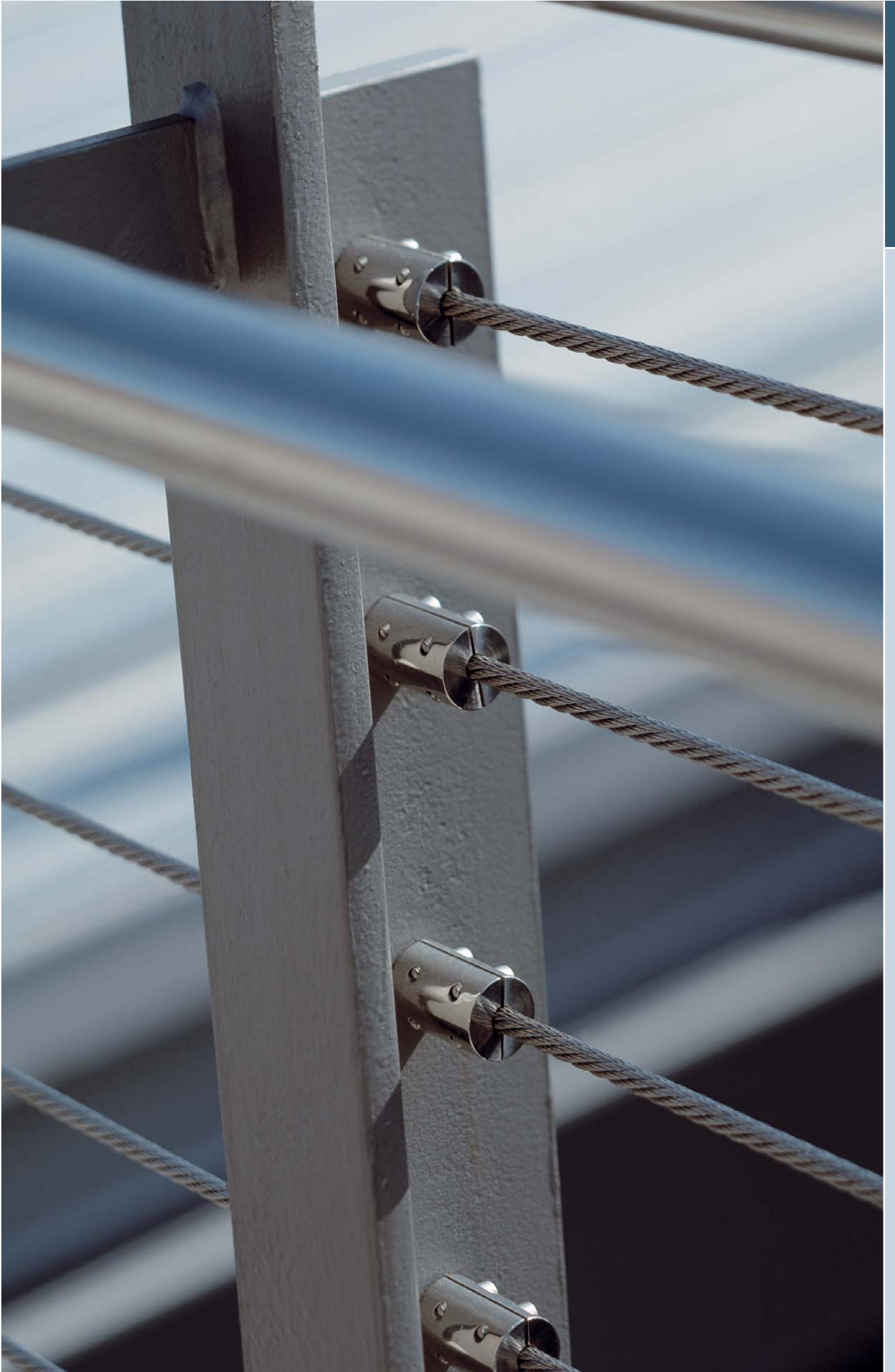



I-SYS: Cables, Loops, Clamps, Accessories

Stainless steel cables are some of the most adaptable elements within architecture. Of static significance or decorative, fine or functional, discreetly integrated or designed to be eye-catching - cables really add to the creative possibilities of building. With diameters of between 1 and 26 millimeters and end connections from M4 to M36, I-SYS offers the right range for individual applications. With I-SYS, the formal unit of cable and connection becomes a perfect architectural detail.

Ready-assembled or ready to assembly - Carl Stahl follows the individual wishes of its clients. For the end result is what matters. The professional team of I-SYS advisors will find suitable solutions for all questions of planning, pre-assembly, manufacture and final erection and assembly.



Strand 1 x 19

Part number	ø	kN	MQ mm ²
810-0200	2	3,30	2,39
810-0300	3	7,42	5,37
810-0400	4	13,20	9,55
810-0500	5	20,60	14,92
810-0600	6	29,70	21,49
810-0800	8	49,40	38,20
810-1000	10	77,20	59,69
810-1200	12	104	85,95
810-1400	14	131	116,99
810-1600	16	176	152,81
810-1900	19	233	215,48
810-2200	22	299	288,90
810-2600	26	416	403,51

Material 1.4401



Rope 7 x 7

Part number	ø	kN	MQ mm ²
820-0100	1	0,56	0,43
820-0200	2	2,24	1,71
820-0300	3	5,03	3,85
820-0400	4	8,94	6,85
820-0500	5	14	10,70
820-0600	6	20,10	15,42
820-0800	8	35,80	27,40

Material 1.4401



Strand 1 x 37 | 1 x 61*

Part number	ø	kN	MQ mm ²
610-1600	16	184,6	150,8
610-1800	18	227,5	190,8
610-2200*	22	322	285,1
610-2600*	26	445	398,2

Material 1.4401



Rope 7 x 19

Part number	ø	kN	MQ mm ²
830-0200	2	2,84	1,66
830-0300	3	4,69	3,73
830-0400	4	8,34	6,63
830-0500	5	13	10,36
830-0600	6	18,8	14,92
830-0800	8	33,4	26,53
830-1000	10	52,1	41,45
830-1200	12	75,1	59,69
830-1400	14	102	81,25
830-1600	16	133	106,12

Material 1.4401



Rod with both sides external thread

Part number	ø	Thread size x length c	kN*
IS-625	6	M6 x 25	3,88
IS-830	8	M8 x 30	7,08
IS-1040	10	M10 x 40	11,22
IS-1250	12	M12 x 50	16,31
IS-1660	16	M16 x 60	30,38

Material 1.4571 | Rod length maximum 2 m

*permissible load

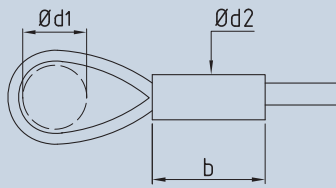

Loop swaged without thimble

Part number	ø rope	b	ø d1	ø d2	kN
803-0200	2	10	x	4	2
803-0300	3	13	x	6	4,5
803-0400	4	16	x	8	8,1
803-0500	5	20	x	10	12,6
803-0600	6	28	x	12	18,1
803-0800	8	40	x	16	32,2
803-1000	10	50	x	20	46,9
803-1200	12	60	x	24	67,6
803-1400	14	70	x	28	91,8
803-1600	16	80	x	32	119,7

Inox-ferrule | Material 1.4404 | Dimension ø d1 variable.
Not suitable for strands

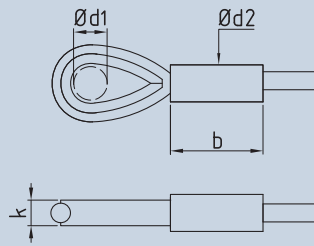

Loop swaged with thimble

Part number	ø rope	b	ø d1	ø d2	k	kN
804-0200	2	10	6,5	7	4	2
804-0300	3	13	9,5	9	5,5	4,5
804-0400	4	16	10,5	13	6,5	8,1
804-0500	5	20	12,5	15	8	12,6
804-0600	6	28	15,5	13	9	18,1
804-0800	8	40	17,5	16	12	32,2
804-1000	10	50	23,5	20	14	46,9
804-1200	12	60	25,5	24	20	67,6
804-1400	14	70	33,5	28	22	91,8
804-1600	16	80	36,5	32	24	119,7

Inox-ferrule | Material 1.4404
Not suitable for strands

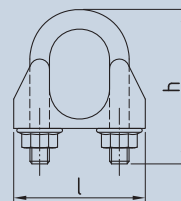

Wire rope grip

Part number	Grips		h	l
	ø rope	per Loop		
800-0200	2	3	18	14
800-0300	3	3	24	17
800-0400	4	3	24	19
800-0500	5	4	33	24
800-0600	6	4	33	28
800-0800	8	4	40	34
800-1000	10	4	50	45
800-1200	12	4	60	51
800-1400	14	4	65	53
800-1600	16	4	75	60

Material 1.4401 | Not suitable for strands





Loop clamp ring with thimble

Part number	ø rope	a	b	ø d1	ø d2	k	kN
874-0300	3	M4	27	22	9,5	5,5	4,9
874-0400	4	M4	27	22	10,5	6,5	5,1
874-0500	5	M4	42	28	12,5	8	7,8
874-0600	6	M4	42	28	15,5	9	12
874-0800	8	M4	42	28	17,5	12	13

Material 1.4401 | Not suitable for strands

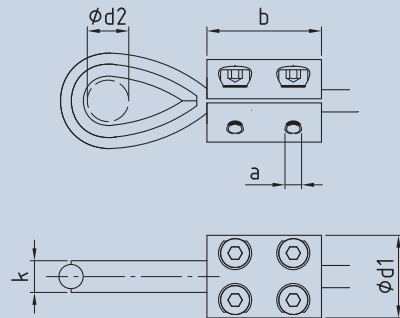

Light clamp ring with thimble

Part number	ø rope	a	b	ø d1	ø d2	k	kN
874-0200-01	2	M3	10	15	6,5	4	1,1
874-0300-01	3	M3	10	15	9,5	5,5	2,4
874-0400-01	4	M4	10	20	10,5	6,5	4

Material 1.4401 | Not suitable for strands

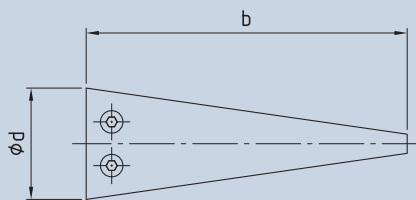
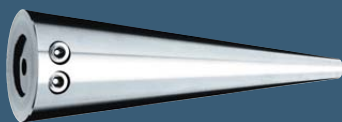
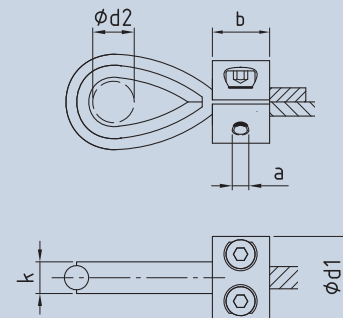

Rope clamp cone

Part number	ø rope	F ax	b	ø d
859-0300-03	3	1,3	90	30
859-0400-03	4	1,5	90	30

Material 1.4401 | Not suitable for strands



Cover disk for rope clamp cone

Part number	ø d1	ø d2	k
859-03-04	30	4,5	4

Material 1.4571

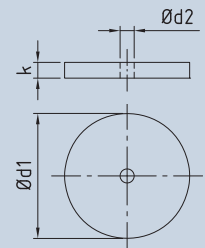

Cross clamp with connection

Part number	ø rope	l1	l2	ø d
858-0400-04	3/4	28	15	25
858-0600-04	5/6	32	15	25

Material 1.4401

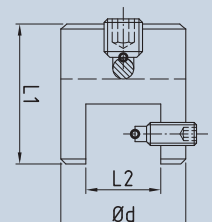

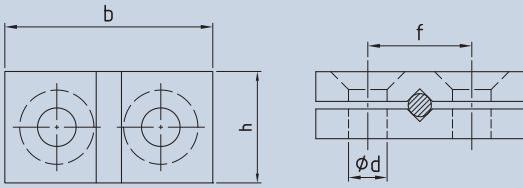

Two part side clamp

Part number	ø rope	b	h	f	ød
833-0200	2	28	15	14	5,2
833-0300	3	28	15	14	5,2
833-0400	4	28	15	14	5,2
833-0500	5+6	28	15	14	5,2

Material 1.4404 | Not suitable for strands

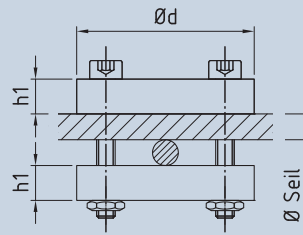

CS-Cross clamp adjustable

Part number	ø rope	ød	h1	h2
858-36	4-6	36	6	6
858-42	8-12	42	8	8



Material 1.4401

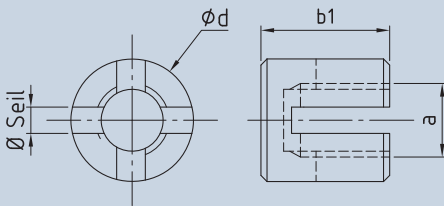

Cross clamp 90°

Part number	ø rope	a	b1	ød
858-0400	3/4	M12	21	20
858-0600	5/6	M12	25	20



Material 1.4401

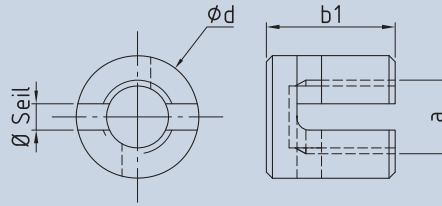

Cross clamp adjustable

Part number	ø rope	a	b1	ød
858-0400-01	3/4	M12	19,5	20
858-0600-01	5/6	M12	23,5	20



Material 1.4401



Cross clamp with internal thread adjustable

Part number	ø rope	a1	a2	b1	ød	c
858-0400-02	3/4	M12	M8	31	20	15
858-0600-02	5/6	M12	M8	35	20	15



Material 1.4401

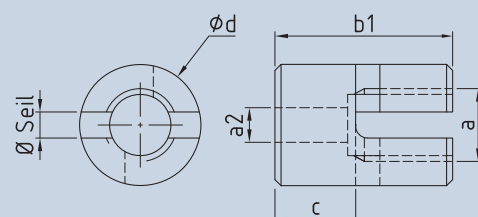

Clamps

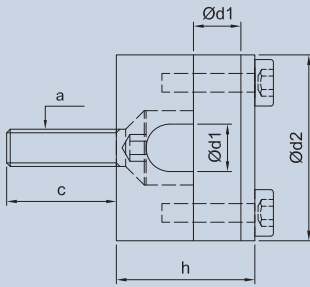

Adjustable screw on cross clamp

Part number	a	c	h	Ød1	Ød2
1858-1000-07	M8	19	30	10,2	40

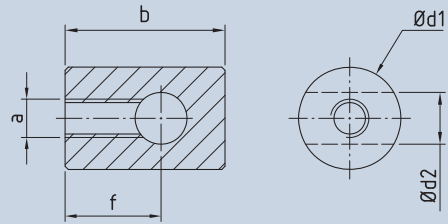
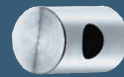

Rod/Rope holder

Part number	a	b	Ød1	Ød2	f
921-0600-12	M6	25	16	8,1	15
921-1000-12	M12	35	28	11,5	19
921-1200-12	M12	35	28	15	19

Material 1.4404

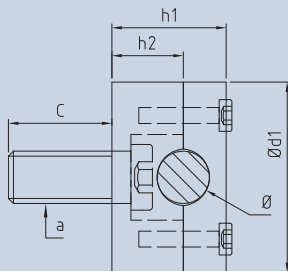

Screw on cross clamp

Part number	Ø rope	a	c	h1	h2	Ød1
858-0800-06	8	M8	16	25	15	40
858-1000-06	10	M8	16	25	15	40
858-1200-06	12	M8	16	25	15	40
858-1600-06	16	M10	16	32	19,5	48



Material 1.4404

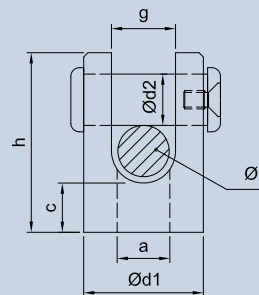

Rope guiding, fork head

Part number	Ø rope	a	c	Ød1	Ød2	h	g
921-1000-28	8/10	M12	13	28	11±0,2	48	12
921-1200-28	12	M12	13	28	11±0,2	48	13,5



Clamp ring

Part number	ø rope	F ax	a	b	ø d1
873-0300	3	3	M4	27	22
873-0400	4	3,6	M4	27	22
873-0500	5	5,8	M5	42	28
873-0600	6	6,5	M5	42	28
873-0800	8	9,4	M5	42	28

Material 1.4401 | Not suitable for strands

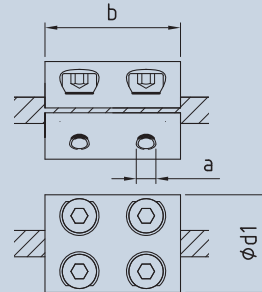

Light clamp ring with adapter

Part number	ø rope	F ax	ø b	ø d	h	a
863-0200-02	2	1	15	30	11,5	M3
863-0300-02	3	1,3	15	30	11,5	M3
863-0400-02	4	1,5	15	30	11,5	M3
863-0500-02	5	2	20	35	11,5	M4
863-0600-02	6	2,2	20	35	11,5	M4
863-0800-02	8	2,2	20	35	11,5	M4

Material 1.4401 | Not suitable for strands

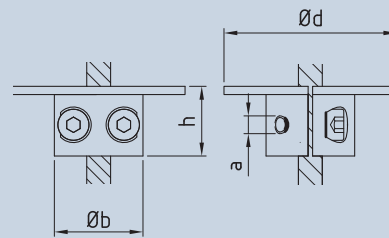

Light clamp ring

Part number	ø rope	F ax	a	b	ø d1
863-0200	2	1	M3	10	15
863-0300	3	1,3	M3	10	15
863-0400	4	1,5	M3	10	15
863-0500	5	2	M4	10	24
863-0600	6	2,2	M4	10	24
863-0800	8	2,2	M4	10	24

Material 1.4401 | Not suitable for strands

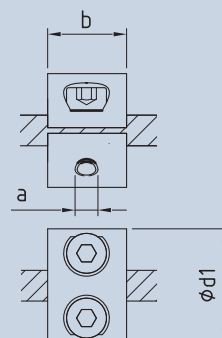

Loops, Clamps | Assembly

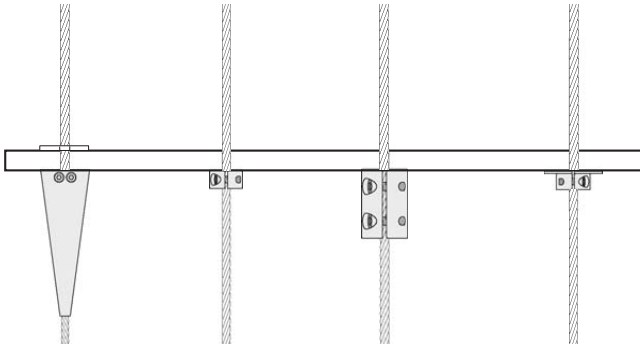

Loop clamps attached to bow shackle.

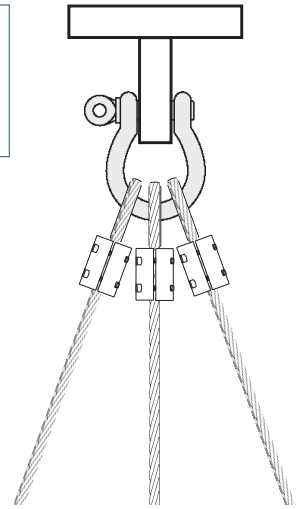

Cable cone clamp with cover disc, light clamp ring, clamp ring, light clamp ring with support for horizontal hanging of shelves and tablets.

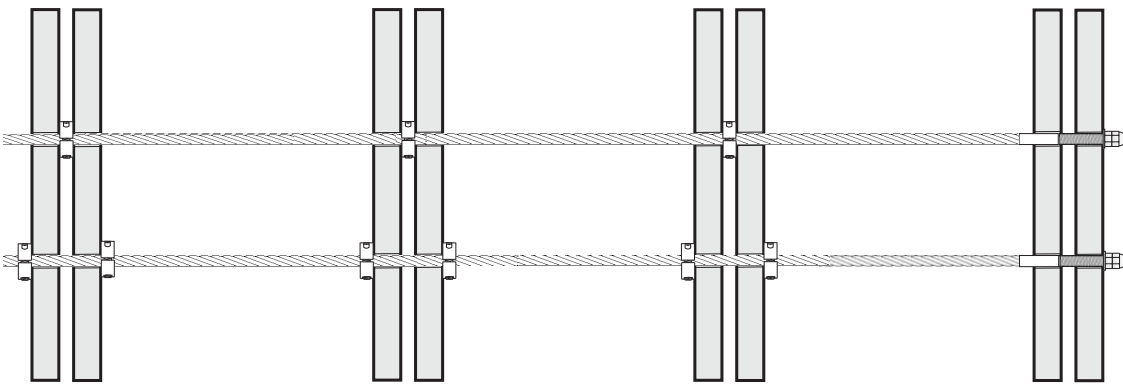

Light clamp rings for distribution of tensile forces over several profiles.

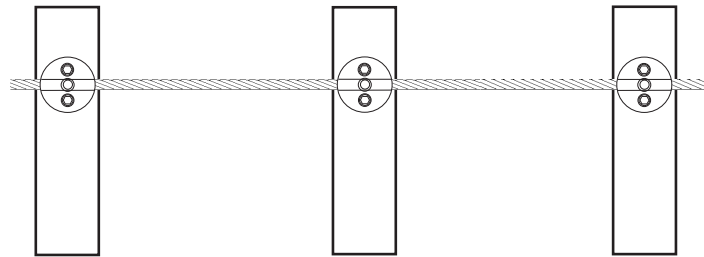

Two-part screw clamp for cable guide and clamping.

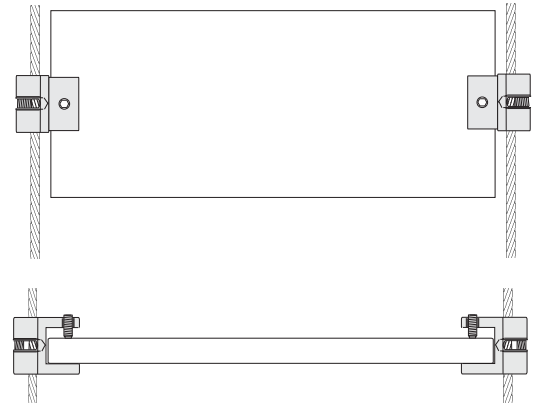

Double cable junction with clamping holder for horizontal and vertical hanging of displays and shelves.

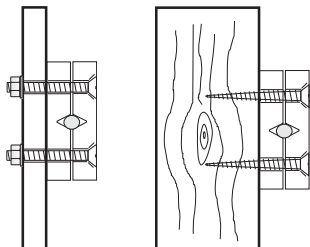

Two-part clamping plate for horizontal and vertical hanging of displays and shelves.



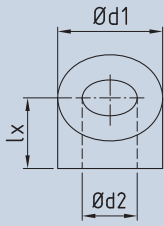

Angle stand off washer for external thread, flat profile

Part number	Thread	$\varnothing d1$	$\varnothing d2$
862-04-0	M4	10	4,3
862-05-0	M5	10	5,5
862-06-0	M6	13	7,3
862-08-0	M8	18	8,3
862-10-0	M10	22	10,5
862-12-0	M12	24	12,5
862-16-0	M16	32	17

Material 1.4301
Please specify the required angle when ordering.

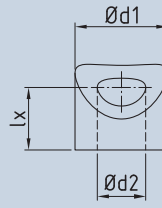

Angle stand off washer for external thread, round profile

Part number	Thread	$\varnothing d1$	$\varnothing d2$
862-04-1	M4	10	4,3
862-05-1	M5	10	5,5
862-06-1	M6	13	7,3
862-08-1	M8	18	8,3
862-10-1	M10	22	10,5
862-12-1	M12	24	12,5
862-16-1	M16	32	17

Material 1.4301
Please specify diameter of post and required angle when ordering.

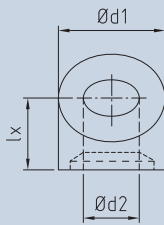

Angle washer for countersunk end stop 90°, flat profile

Part number	$\varnothing rope$	$\varnothing d1$	$\varnothing d2$
862-03-2	3	13	7,3
862-04-2	4	13	8,3
862-05-2	5	18	8,3
862-06-2	6	18	10,5
862-08-2	8	24	13,5

Material 1.4301
Please specify the required angle when ordering.

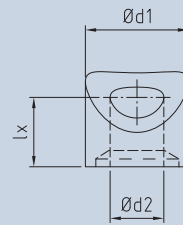

Angle washer for countersunk end stop 90°, round profile

Part number	$\varnothing rope$	$\varnothing d1$	$\varnothing d2$
862-03-3	3	13	7,3
862-04-3	4	13	8,3
862-05-3	5	18	8,3
862-06-3	6	18	10,5
862-08-3	8	24	13,5

Material 1.4301
Please specify diameter of post and required angle when ordering.

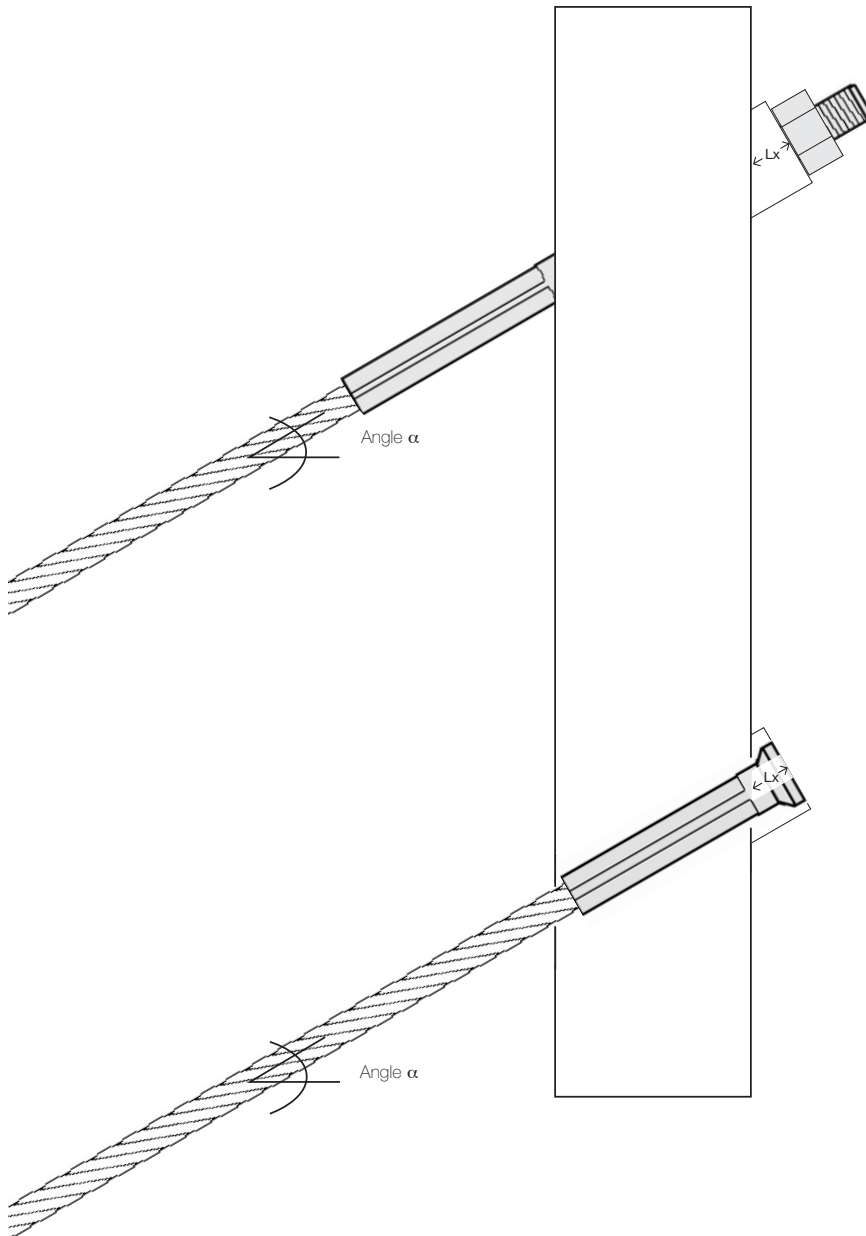

Length Lx for angled stand off washers

Angle α	$\varnothing d1$ (8 mm)	$\varnothing d1$ (10 mm)	$\varnothing d1$ (13 mm)	$\varnothing d1$ (18 mm)	$\varnothing d1$ (22 mm)	$\varnothing d1$ (24 mm)	$\varnothing d1$ (32 mm)
0°	3,0	3,0	3,0	3,0	3,0	7,0	7,0
5°	3,4	3,4	4,6	4,0	4,0	7,9	8,4
10°	3,7	3,9	4,6	4,6	4,9	8,4	9,8
15°	4,1	4,3	5,0	5,4	5,9	9,1	11,3
20°	4,5	4,8	5,5	6,3	7,0	9,8	12,8
25°	4,9	5,3	6,0	7,2	8,1	10,2	14,5
30°	5,3	5,9	7,0	8,2	9,4	11,2	16,2
32°	5,5	6,1	7,1	8,6	9,9	11,5	17
35°	5,8	6,5	7,6	9,3	10,7	12,5	18,2
37°	6,0	6,8	7,9	9,8	11,3	13,0	19,1
40°	6,4	7,2	8,5	10,6	12,2	13,5	20,4
45°	7,0	8,0	9,5	12,0	14,0	15,0	23
50°	7,8	9,0	10,7	13,7	16,1	17,3	26,1
55°	8,7	10,1	12,3	15,9	18,7	20,1	30
60°	9,9	11,7	14,3	18,6	22,0	23,8	34,7

For round post profiles specify the angle as well as the outside diameter of the post.

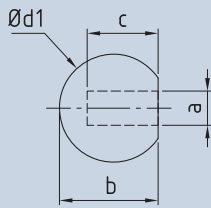

Ball end with internal thread

Part number RH thread	Part number LH thread	a	b	c	Ød1
898-0400-01	898-0400-02	M4	15	9	16
898-0500-01	898-0500-02	M5	15	9	16
898-0600-01	898-0600-02	M6	18,8	10	20
898-0800-01	898-0800-02	M8	22,4	12	24
898-1000-01	898-1000-02	M10	21,4	12	24

Material 1.4401

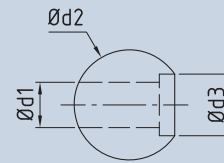
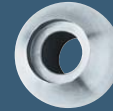

Ball for internal thread radius head

Part number	Ød1	Ød2	Ød3
899-06	6,5	20	10
899-07	7,5	20	12
899-08	9	25	14
899-10	11	25	16

Material 1.4401

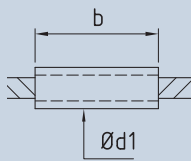

Loose sleeve

Part number	Ø rope	Ø d	b
864-0205	2	5	30
864-0206	2	6	30
864-0306	3	6	30
864-0307	3	7	30
864-0310	3	10	30
864-0407	4	7	30
864-0407 M	4	7	40
864-0407 L	4	7	55
864-0408	4	8	30
864-0408 M	4	8	40
864-0408 L	4	8	55
864-0410	4	10	30
864-0508	5	8	30
864-0508 M	5	8	40
864-0508 L	5	8	55
864-0513	5	13	30
864-0610	6	10	30
864-0610 M	6	10	40
864-0610 L	6	10	55
864-0613	6	13	30
864-0813	8	13	30
864-1018	10	18	50
864-1020	10	20	50
864-1222	12	22	50
864-1225	12	25	50
864-1424	14	24	50
864-1627	16	27	50
864-1632	16	32	50

Material 1.4404 | The sleeve can slide along the length of the cable. Secure the sleeve to the post profile not the rope.

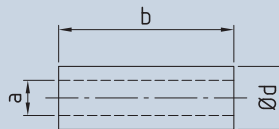

Thread sleeve

Part number	a	b	Ø d
876-0625	M6	25	10
876-0830	M8	30	11
876-1030	M10	30	13
876-1230	M12	30	15
876-1640	M16	40	25

Material 1.4401

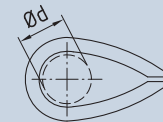

Thimble

Part number	Ø rope	d1
5970.00.02	2	6,5
5970.00.03	3	9,5
5970.00.04	4	10,5
5970.00.05	5	12,5
5970.00.06	6	15,5
5970.00.08	8	17,5
5970.00.10	10	23,5
5970.00.12	12	25,5
5970.00.14	14	33,5
5970.00.16	16	36,5

Material 1.4401



Shackle

Part number	kN	b1	b2	Ø d1	Ø d2	Ø d3
835-0032	10,79	8	17	4	4	9
835-0039	15,01	12	21	5	5	11
835-0050	28,45	13	23	6	6	13
835-0090	44,15	15	30	8	8	17
835-0120	59,84	20	36	9	9	19
835-0140	88,29	26	45	12	12	24
835-0200	112,82	32	61	16	16	32
835-0340	152,06	38	76	19	19	38

Material 1.4401

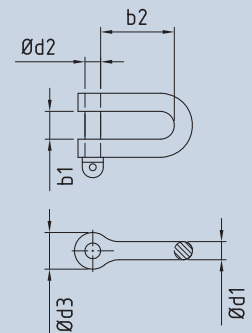

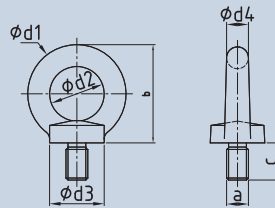

Eye bolt

Part number	kN	a	b	c	$\phi d1$	$\phi d2$	$\phi d3$	$\phi d4$
837-0600*	4,2	M6	36	13	36	20	20	8
837-0800	8,4	M8	36	13	36	20	20	8
837-1000	13,8	M10	45	17	45	25	25	10
837-1200	19,8	M12	53	21	54	30	30	12
837-1600	41,4	M16	62	27	63	35	35	14
837-2000	70,8	M20	71	30	72	40	40	16
837-2400	106	M24	90	36	90	50	50	20

Material 1.4401, DIN 580, *similar to DIN 580

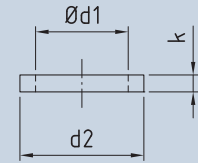

Scheibe

Part number	$\phi d1$	$\phi d2$	k
896-0400	M4	8	0,5
896-0500	M5	9	1
896-0600	M6	11	1,6
896-0800	M8	15	1,6
896-1000	M10	18	1,6
896-1200	M12	20	2
896-1400	M14	15	2,5
896-1600	M16	28	2,5
896-2000	M20	34	3
896-2200	M22	39	3
896-2400	M24	44	4
896-3000	M30	56	4

Material 1.4404

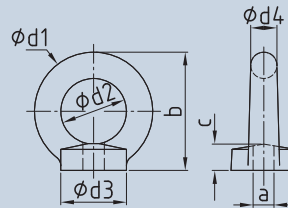

Eye nut

Part number	kN	a	b	c	$\phi d1$	$\phi d2$	$\phi d3$	$\phi d4$
838-0600*	4,2	M6	36	8	36	20	20	8
838-0800	8,4	M8	36	8	36	20	20	8
838-1000	13,8	M10	45	10	45	25	25	10
838-1200	19,8	M12	53	11	54	30	30	12
838-1600	41,4	M16	62	13	63	35	35	14
838-2000	70,8	M20	71	15	72	40	40	16
838-2400	106	M24	90	20	90	50	50	20

Material 1.4401, DIN 582, *similar to DIN 582

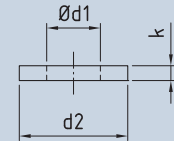

Washer for wood

Part number	$\phi d1$	$\phi d2$	k
896-0400-12	M4	12	1
896-0500-15	M5	15	1,2
896-0600-18	M6	18	1,6
896-0800-24	M8	24	2
896-1000-30	M10	30	2,5
896-1200-37	M12	37	3
896-1600-50	M16	50	3
896-2000-60	M20	60	4

Material 1.4301

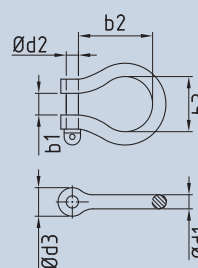

Bow shackle

Part number	kN	b1	b2	b3	$\phi d1$	$\phi d2$	$\phi d3$
835-0016-01	5,89	8	18	14	4	4	8
835-0024-01	10,20	10	23	17	5	5	10
835-0036-01	14,13	12	26	21	6	6	12
835-0056-01	27,47	16	36	28	8	8	16
835-0086-01	42,38	20	46	34	10	10	20
835-0130-01	56,51	24	54	42	12	12	24

Material 1.4401

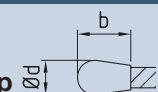

Wire rope end cap

Part number	ϕ rope	b	ϕd
904-0200	2	10,2	6,3
904-0300	3	8,8	5,5
904-0400	4	8,8	5,5
904-0500	5	8	7,5
904-0600	6	12	7,5
904-0800	8	13	11,5
904-1000	10	14,6	13,4

Black plastic

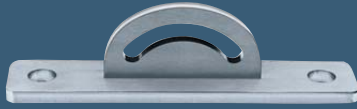

Fork bracket

Part number	h	c	b	ød	e	g	k
834-006	150	120	30	12	8	6	40
834-012	262	210	53	14	14	12	70

Material 1.4404

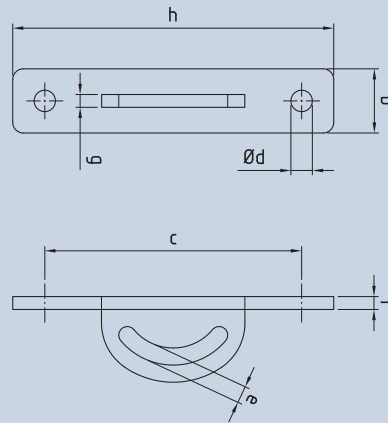

Socket head screw

Part number	a	c	ød	k
844-0400	M4	25	7	4
844-0500	M5	25	8,5	5
844-0600	M6	30	10	6
844-0800	M8	35	13	8
844-1000	M10	40	16	10
844-1200	M12	50	18	12
844-1600	M16	60	24	16
844-2000	M20	70	30	20

Material 1.4404

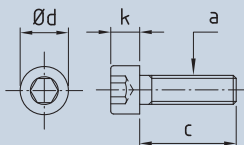

Cylindrical turnbuckle barrel LH/RH

Part number	a	b	c	ød	sw
875-0500-01	M5	60	25	8	7
875-0500-02	M5	100	45	8	7
875-0600-01	M6	70	30	10	9
875-0600-02	M6	120	55	10	9
875-0800-01	M8	70	30	12	11
875-0800-02	M8	120	55	12	11

Material 1.4401

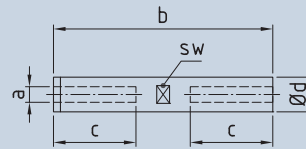

Turnbuckle barrel with internal thread LH/RH

Part number	a	b	ød
875-0500	M5	80	8
875-0600	M6	92	10
875-0800	M8	112	13,5
875-1000	M10	120	17,2
875-1200	M12	150	21,3
875-1400	M14	170	21,3
875-1600	M16	190	26,9
875-2000	M20	220	33,7
875-2400	M24	328	50

Material 1.4401

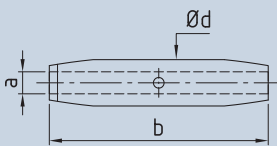

Hexagon nut

Part number	Part number	a	d	k	sw
RH thread	LH thread				
892-0400	893-0400	M4	7,7	3,2	7
892-0500	893-0500	M5	8,8	4	8
892-0600	893-0600	M6	11,1	5	10
892-0800	893-0800	M8	14,4	6,5	13
892-1000	893-1000	M10	18,9	8	17
892-1200	893-1200	M12	21,1	10	19
892-1400	893-1400	M14	24,5	11	22
892-1600	893-1600	M16	26,8	13	24
892-2000	893-2000	M20	33,5	16	30
892-2200	893-2200	M22	35	18	32
892-2400	893-2400	M24	39,5	19	36
892-2700	893-2700	M27	48	24	41
892-3000	893-3000	M30	50,8	24	46
892-3600	893-3600	M36	64	31	55

Material 1.4404

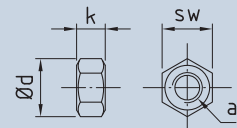

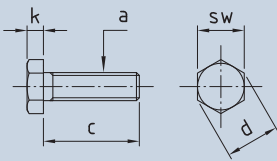

Hexagon head screw

Part number	a	c	d	k	sw
843-0400	M4	25	7,7	2,8	7
843-0500	M5	30	8,8	3,5	8
843-0600	M6	30	11,1	4	10
843-0800	M8	40	14,4	5,3	13
843-1000	M10	50	18,9	6,4	17
843-1200	M12	70	21,1	7,5	19
843-1400	M14	70	24,5	8,8	22
843-1600	M16	90	26,8	10	24
843-2000	M20	100	33,5	12,5	30

Material 1.4404

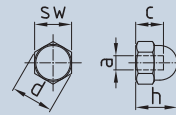

Dome nut RH

Part number	a	c	h	d	sw
894-0400	M4	4,1	8	7,7	7
894-0500	M5	5,9	10	8,8	8
894-0600	M6	6	12	11,1	10
894-0800	M8	8,5	15	14,4	13
894-1000	M10	10	18	18,9	17
894-1200	M12	11,7	22	21,1	19
894-1400	M14	13	25	24,5	22
894-1600	M16	16	28	26,8	24
894-2000	M20	19,7	34	33,5	30

Material 1.4404

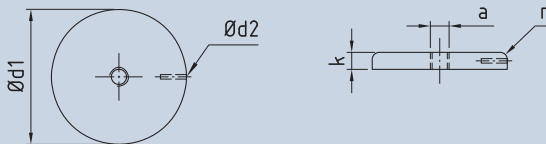

Cover disk with internal thread

Part number RH thread	Part number LH thread	a	Ød1	Ød2	r	k
836-0500-05	836-0500-06	M5	35	1,5	2,5	4
836-0600-05	836-0600-06	M6	35	1,5	2,5	4
836-0800-05	836-0800-06	M8	50	3,5	3	6
836-1000-05	836-1000-06	M10	50	3,5	3	6

Material 1.4404

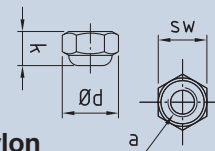

Lock nut with nylon insert RH

Part number	a	d	k	sw
892-0400-02	M4	7,7	5	7
892-0500-02	M5	8,8	5	8
892-0600-02	M6	11,1	6	10
892-0800-02	M8	14,4	8	13
892-1000-02	M10	18,9	10	17
892-1200-02	M12	21,1	12	19
892-1400-02	M14	24,5	14	22
892-1600-02	M16	26,8	16	24
892-2000-02	M20	33	20	30

Material 1.4404

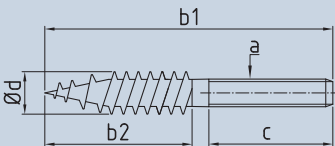

Dual thread screw

Part number RH thread	Part number LH thread	a	b1	b2	c	Ød
878-0500	877-0500	M5	50	30	20	4,3
878-0600	877-0600	M6	70	40	30	5,2
878-0800	877-0800	M8	100	60	40	6,9

Material 1.4404 | Ød = for wall plug

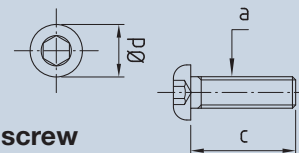

Pan head screw

Part number	a	c	Ød
890-0400-025	M4	25	7,5
890-0500-020	M5	20	9,5
890-0500-025	M5	25	9,5
890-0500-030	M5	30	9,5
890-0600-020	M6	20	10,5
890-0600-025	M6	25	10,5
890-0600-030	M6	30	10,5
890-0800-030	M8	30	14
890-0800-040	M8	40	14

Material 1.4404



Threaded rod

Part number RH thread	Part number LH thread	a	c
882-0500-060	883-0500-060	M5	60
882-0500-100	883-0500-100	M5	100
882-0600-060	883-0600-060	M6	60
882-0600-100	883-0600-100	M6	100
882-0800-060	883-0800-060	M8	60
882-0800-120	883-0800-120	M8	120
882-0800-220	883-0800-220	M8	220
882-1000-060	883-1000-060	M10	60
882-1200-080	883-1200-080	M12	80
882-1200-180	883-1200-180	M12	180
882-1200-220	883-1200-220	M12	220
882-1600-080	883-1600-080	M16	80

Material 1.4404

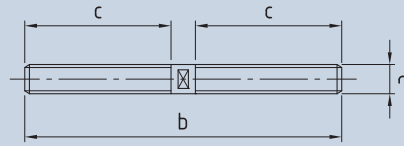

Headless screw RH/LH

Part number	a	b	c
884-0400	M4	45	20
884-0500	M5	65	30
884-0600	M6	65	30
884-0800	M8	65	30
884-1000	M10	85	40
884-1200	M12	105	50
884-1400	M14	105	50
884-1600	M16	125	60
884-2000	M20	125	60

Material 1.4404

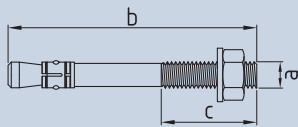

Wall Anchor

Part number	a	b	c	Type
803-0600-08	M6	67	20	B A4
803-0800-08	M8	75	25	BZplus A4
803-1000-08	M10	80	30	BZplus A4
803-1200-08	M12	180	80	BZplus A4

Material 1.4401 | Assembly instructions on request

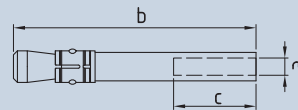

Wall Anchor Z-IG A4

Part number	a	b	c
803-0600-07	M6	50	20
803-0800-07	M8	62	22
803-1000-07	M10	70	23
803-1200-07	M12	86	27

Material 1.4401

Assembly instructions on request



Plastic wall plug for dual thread screw

Part number	b x d	$\varnothing S$
803-0700-03	6 x 36	4,3 - 5
803-0800-03	8 x 51	5 - 6
803-1000-03	10 x 61	6 - 8

b x d = \varnothing Drill hole x Plug length | S = Dual thread screw
Assembly instructions on request



Wire rope cutter

Part number	up to \varnothing rope	Length
740-0500	5	190
740-0800	8	500

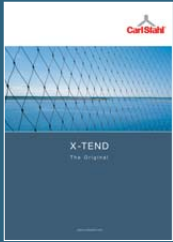

X-TEND,
das flexible Stahlseilnetz.
Netze aus Edelstahlseilen
Ø 1 - 4 mm und Maschenweiten
von 25 - 400 mm



**Allgemeine bauaufsichtliche
Zulassung für
Seilnetzkonstruktionen**

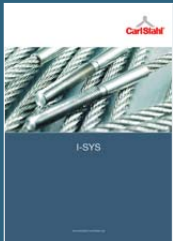

I-SYS,
das Edelstahlseilsystem.
Seile von Ø 1 - 26 mm und
rund 1200 Beschlagteile



**Europäische Technische Zulassung
ETA-10/0358 für Seilzugglieder I-SYS**



I-SYS Edition,
eine Auswahl der gängigsten
I-SYS Komponenten.



POSILOCK,
das filigrane Seilsystem für
den Innenausbau, Messe-
und Ladenbau.
Seile von Ø 1 - 3 mm und
individuell kombinierbare
Beschlagteile



Fassadenbegrünung
Wandhalter, Seile und
Netze für filigrane und
beständige Begrünungen



X-LED,
das Seilnetz kombiniert mit
einem LED-Lichtmodulsystem.



Carl Stahl GmbH | PO Box 1329 | 73079 Suesen | Germany
architektur@carlstahl.com | www.carlstahl-architektur.de