

UMG 104 – Energy measurement device for DIN rails

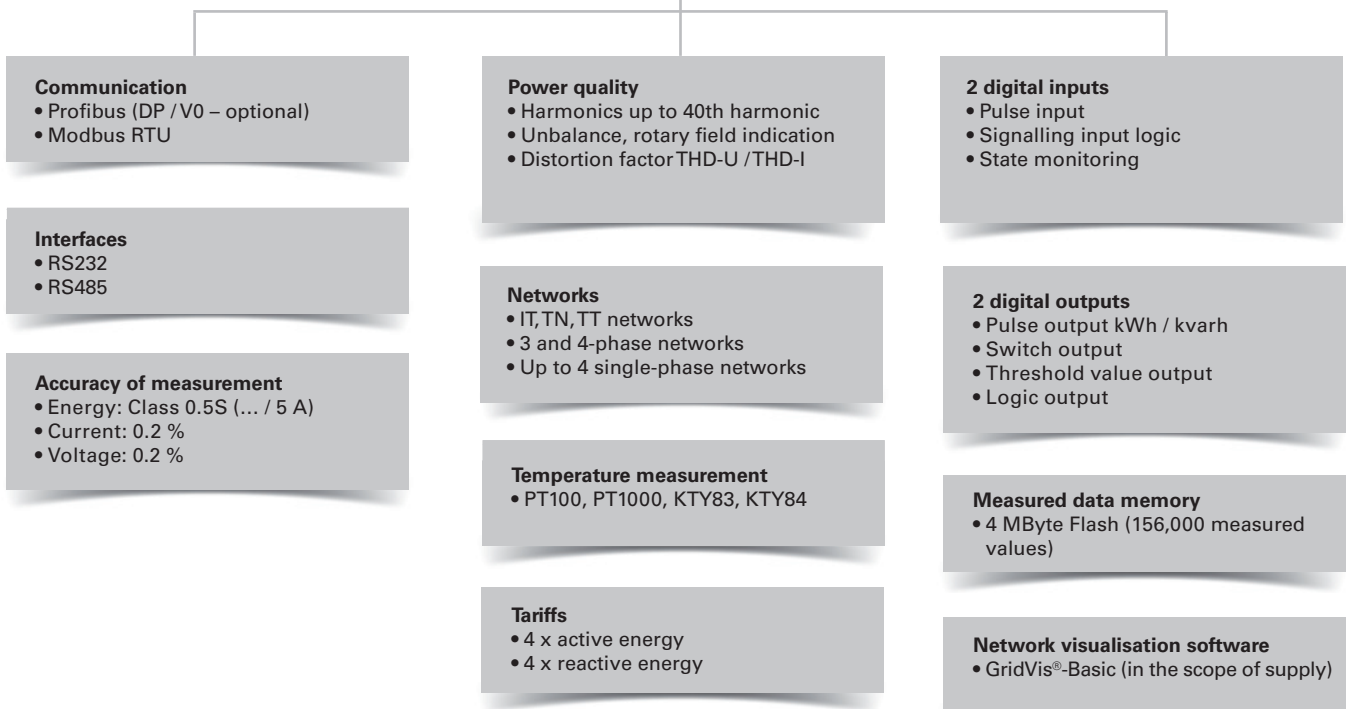



Large measurement data memory

- 4 MByte
- 156,000 saved values
- Recording range dependent on the user-defined measurement data memory configuration over a few months
- Recording freely configurable

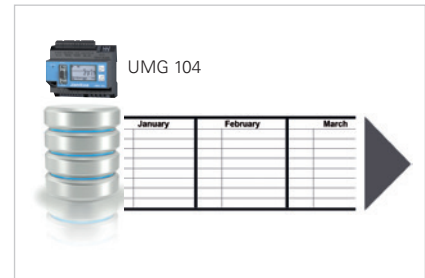

Fig.: Large measurement data memory

Added value through additional functions

The UMG 104 goes far beyond the limits of digital multifunction measurement devices thanks to the integration of additional functions:

- Multifunction measurement device
- State monitoring
- Data logger
- Meters (kWh, kvarh)
- Temperature monitoring
- Harmonics analyser

Due to the four current and voltage inputs there are also particular advantages with the monitoring of up to four single-phase outputs, e.g. in data centres, offices or single-phase motor outputs.



Dimension diagrams

All dimensions in mm

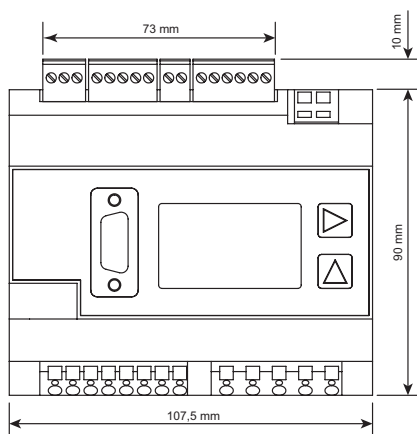

Front view

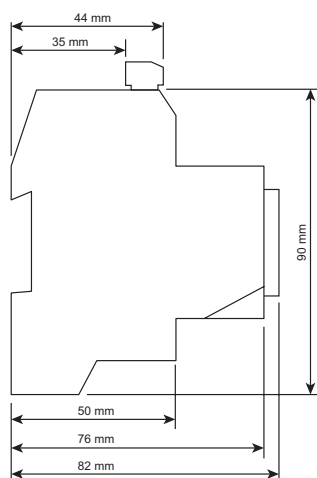

Side view



Typical connection

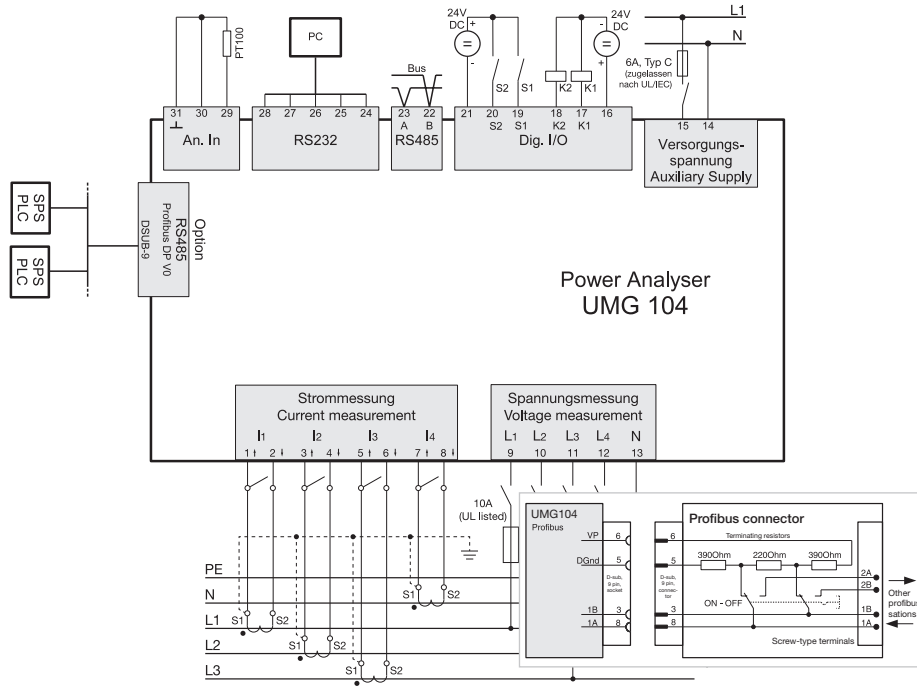

Device overview and technical data

Item number	UMG 104			UMG 104P	
	52.20.001	52.20.003	52.20.005	52.20.002	52.20.006
Item number (UL)	52.20.201	-	-	52.20.202	-
Supply voltage AC	95 ... 240 V AC	50 ... 110 V AC	20 ... 55 V AC	95 ... 240 V AC	20 ... 55 V AC
Supply voltage DC	135 ... 340 V DC	50 ... 155 V DC	20 ... 77 V DC	135 ... 340 V DC	20 ... 77 V DC
Communication					
Interfaces					
RS485: 9.6 – 921.6 kbps (Screw-type terminal)	•	•	•	•	•
RS232: 9.6 – 115.2 kbps (Screw-type terminal)	•	•	•	•	•
Profibus DP: Up to 12 Mbps (DSUB-9-socket)	-	-	-	•	•

General	
Use in low and medium voltage networks	•
Accuracy voltage measurement	0.2 %
Accuracy current measurement	0.2 %
Accuracy active energy (kWh, .../5 A)	Class 0.5S
Number of measurement points per period	400
Uninterrupted measurement	•
RMS - momentary value	
Current, voltage, frequency	•
Active, reactive and apparent power / total and per phase	•
Power factor / total and per phase	•

Comment: For detailed technical information please refer to the operation manual and the Modbus address list.

• = included - = not included

An RS232 connecting cable is not included in the delivery and must be ordered separately as item no. 08.02.427.

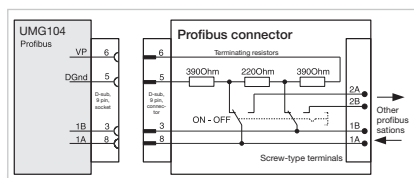

Fig.: Profibus connector, contact allocation

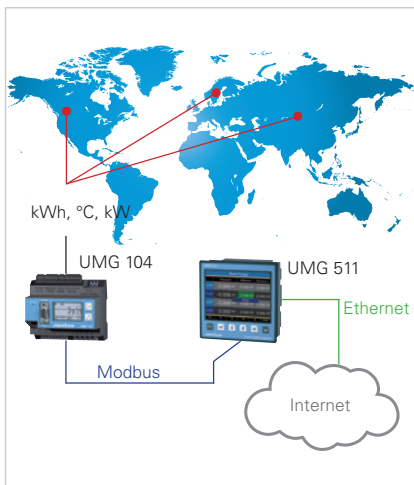

Fig.: Word-wide remote monitoring of the energy consumption and temperature for various different locations

Comment: For detailed technical information please refer to the operation manual and the Modbus address list.

• = included - = not included

*1 Optional additional functions with the packages GridVis®-Professional, GridVis®-Enterprise and GridVis®-Service.

Energy measurement	
Active, reactive and apparent energy [L1,L2,L3, L4, Σ L1-L3, Σ L1-L4]	•
Number of tariffs	8
Recording of the mean values	
Voltage, current / actual and maximum	•
Active, reactive and apparent power / actual and maximum	•
Frequency / actual and maximum	•
Demand calculation mode (bi-metallic function) / thermal	•
Other measurements	
Clock	•
Power quality measurements	
Harmonics per order / current and voltage	1st – 40th
Harmonics per order / active and reactive power	1st – 40th
Distortion factor THD-U in %	•
Distortion factor THD-I in %	•
Voltage unbalance	•
Rotary field indication	•
Current and voltage, positive, zero and negative sequence component	•
Measured data recording	
Memory (Flash)	4 MB
Average, minimum, maximum values	•
Measured data channels	4
Alarm messages	•
Time stamp	•
Time basis average value	freely user-defined
RMS averaging, arithmetic	•
Displays and inputs / outputs	
LCD display	•
Digital inputs	2
Digital outputs (as switch or pulse output)	2
Thermistor input (PT100, PT1000, KTY83, KTY84)	•
Voltage and current inputs	every 4
Password protection	•
Communication	
Protocols	
Modbus RTU	• / •
Profibus DP V0	- / •
Software GridVis®-Basic*1	
Online graphs	•
Databases (Janitza DB, Derby DB); MySQL, MS SQL with higher GridVis® versions)	•
Manual reports (energy, power quality)	•
Topology views	•
Manual read-out of the measuring devices	•
Graph sets	•
Programming / threshold values / alarm management	
Comparator (2 Groups with 4 comparators each)	•
Technical data	
Type of measurement	Constant true RMS Up to 40th harmonic
Nominal voltage, three-phase, 4-conductor (L-N, L-L)	277 / 480 V AC
Nominal voltage, three-phase, 3-conductor (L-L)	480 V AC
Measurement in quadrants	4
Networks	TN, TT, IT
Measurement in single-phase / multi-phase networks	1 ph, 2 ph, 3 ph, 4 ph and up to 4 times 1 ph
Measured voltage input	
Overvoltage category	300 V CAT III
Measured range, voltage L-N, AC (without potential transformer)	10 ... 600 Vrms
Measured range, voltage L-L, AC (without potential transformer)	18 ... 1,000 Vrms
Resolution	0.01 V
Impedance	4 MOhm / phase
Frequency measuring range	45 ... 65 Hz
Power consumption	approx. 0.1 VA
Sampling frequency	20 kHz / phase

Measured current input	
Rated current	1 / 5 A
Resolution	1 mA
Measurement range	0.001 ... 8.5 Amps
Overvoltage category	300 V CAT III
Measurement surge voltage	4 kV
Power consumption	approx. 0.2 VA (Ri = 5 MOhm)
Overload for 1 sec.	100 A (sinusoidal)
Sampling frequency	20 kHz
Digital inputs and outputs	
Number of digital inputs	2
Maximum counting frequency	20 Hz
Input signal present	18 ... 28 V DC (typical 4 mA)
Input signal not present	0 ... 5 V DC, current < 0.5 mA
Number of digital outputs	2
Switching voltage	max. 60 V DC, 30 V AC
Switching current	max. 50 mA Eff AC / DC
Pulse output (energy pulse)	max. 20 Hz
Maximum cable length	up to 30 m unscreened, from 30 m screened
Mechanical properties	
Weight	350 g
Device dimensions in mm (H x W x D)	90 x 107.5 x approx. 82
Battery	Type Lithium CR2032, 3 V
Protection class per EN 60529	IP20
Assembly per IEC EN 60999-1 / DIN EN 50022	35-mm DIN rail
Connecting phase (U / I), Single core, multi-core, fine-stranded Terminal pins, core end sheath	0.08 to 2.5 mm ² 1.5 mm ²
Environmental conditions	
Temperature range	Operation: K55 (-10 ... +55 °C)
Relative humidity	Operation: 5 to 95 % (at 25 °C)
Operating height	0 ... 2,000 m above sea level
Degree of pollution	2
Installation position	user-defined
Electromagnetic compatibility	
Electromagnetic compatibility of electrical equipment	Directive 2004/108/EC
Electrical appliances for application within particular voltage limits	Directive 2006/95/EC
Equipment safety	
Safety requirements for electrical equipment for measurement, regulation, control and laboratory use – Part 1: General requirements	IEC/EN 61010-1
Part 2-030: Particular requirements for testing and measuring circuits	IEC/EN 61010-2-030
Noise immunity	
Industrial environment	IEC/EN 61326-1
Electrostatic discharge	IEC/EN 61000-4-2
Voltage dips	IEC/EN 61000-4-11
Emissions	
Class B: Residential environment	IEC/EN 61326-1
Radio disturbanc voltage strength 30 – 1000 MHz	IEC/CISPR11/EN 55011
Radiated interference voltage 0.15 – 30 MHz	IEC/CISPR11/EN 55011
Safety	
Europe	CE labelling
USA and Canada	UL variants available
Firmware	
Firmware update	Update via GridVis® software. Firmware download (free of charge) from the website: http://www.janitza.com/downloads/

Comment:
For detailed technical information please refer to the operation manual and the Modbus address list.

• = included - = not included

Janitza electronics GmbH
Vor dem Polstück 1
D-35633 Lahnau
Germany

Tel.: +49 6441 9642-0
Fax: +49 6441 9642-30
info@janitza.de
www.janitza.com

Sales partner

Version 01/2015 • Subject to technical alterations.