

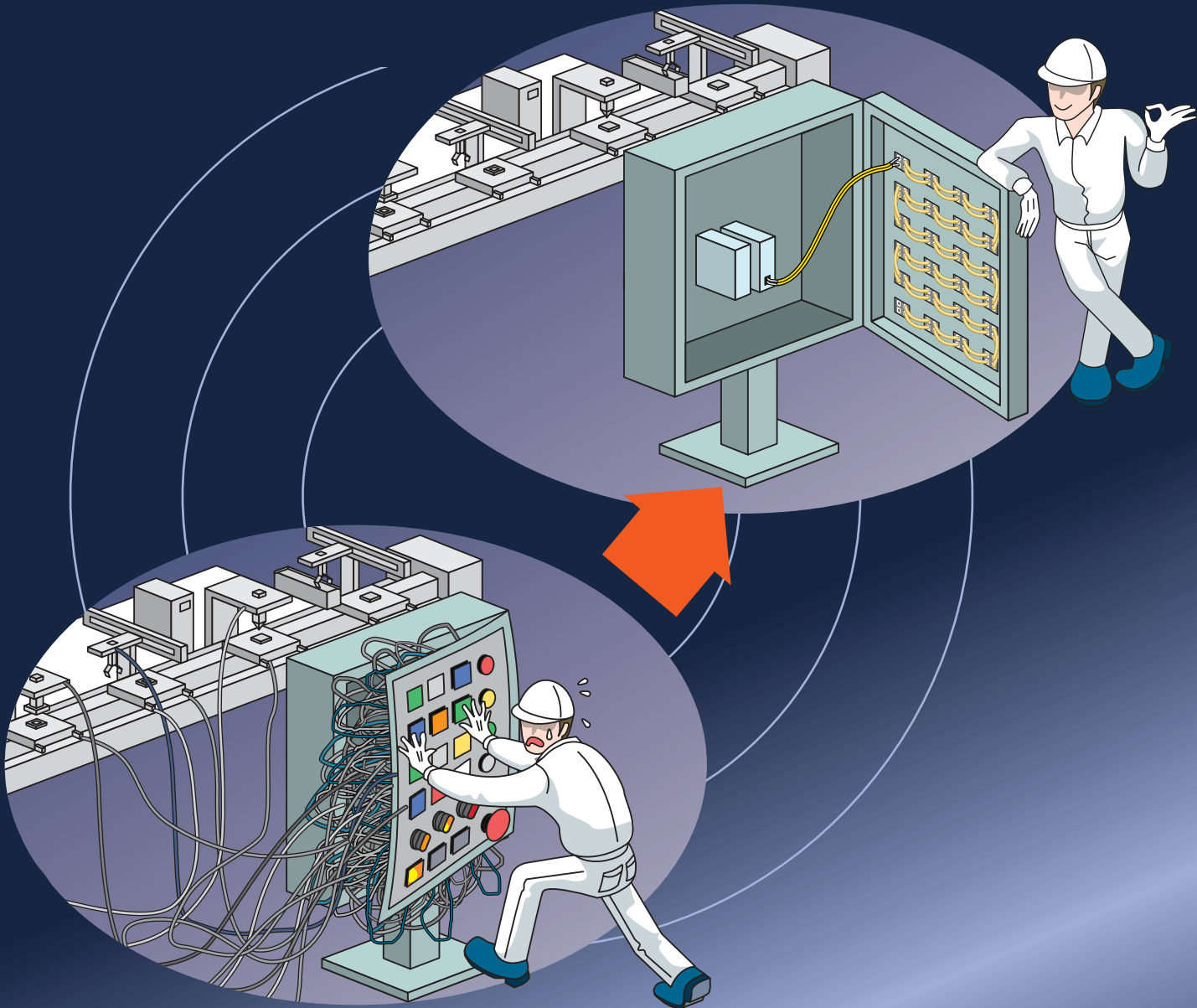

# AS-Interface Devices

- MicroSmart AS-Interface Master Module
- PS2R AS-Interface Power Supplies
- SX5A AS-Interface/CC-Link Gateway
- SX5A AS-Interface/DeviceNet Gateway
- SX5A AS-Interface Communication Terminals  
(Slave Modules)
- SX5A AS-Interface Repeater
- SwitchNet™ HW/L6 Series Control Units





# No more spaghetti wiring!

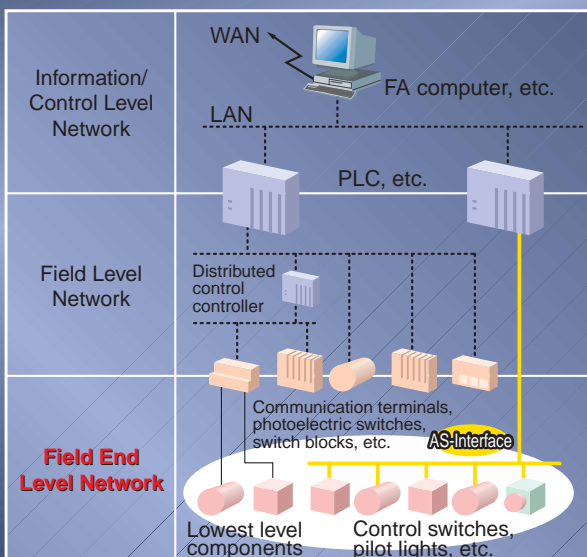

The built-in communication IC for lowest-level components expands the possibility of next-generation production systems.

IDEC's dedication to "Saving" realizes simpler and more convenient systems.

# SwitchNet<sup>®</sup> Control Units directly connect to AS-Interface



What is **SwitchNet**<sup>™</sup>:  
SwitchNet is an IDEC's trade mark for pushbuttons, pilot lights, and other control units capable of direct connection to the AS-Interface. SwitchNet devices are completely compatible with AS-Interface Ver. 2.1.

Conventional bulky wiring

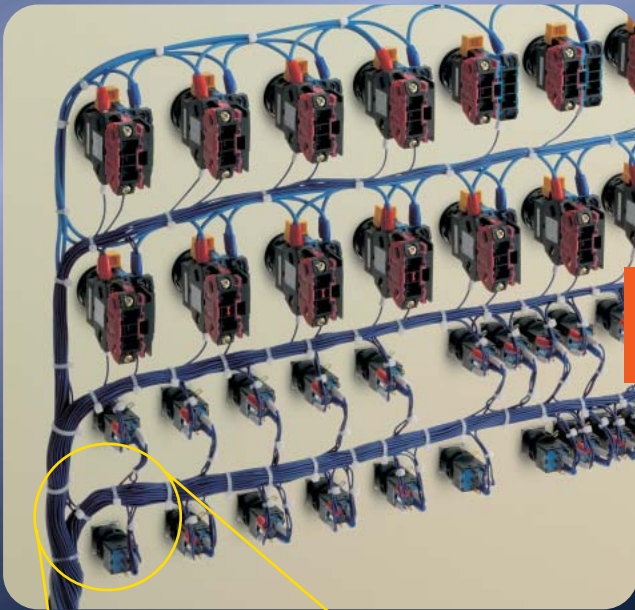

SwitchNet<sup>™</sup> wiring

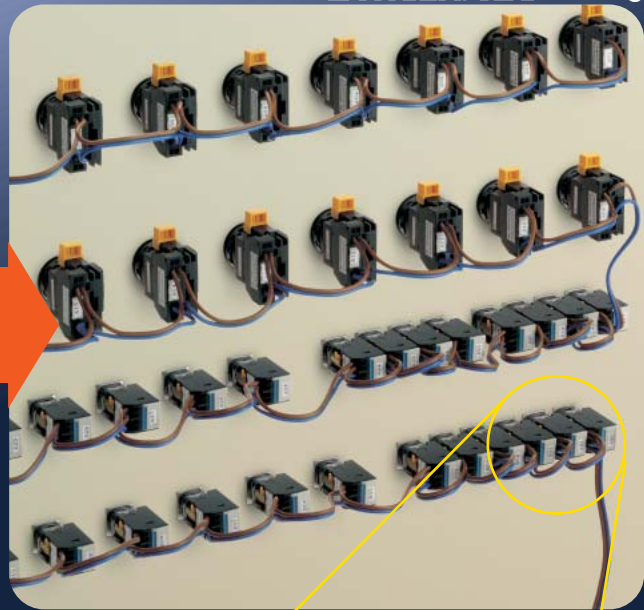







# AS-Interface

(Actuator-Sensor-Interface)

# Link to

<p><b>MicroSmart CPU Module + AS-Interface Master Module + I/O Modules</b></p>  <p><b>1 model</b>    ➔ Page 12</p>	<p><b>AS-Interface / CC-Link Gateway</b></p>  <p><b>1 model</b>    ➔ Page 16</p>	<p><b>AS-Interface / DeviceNet Gateway</b></p>  <p><b>1 model</b>    ➔ Page 18</p>	<p><b>AS-Interface Power Supply</b></p>  <p><b>73W</b>      <b>145W</b></p> <p><b>2 model</b>      ➔ Page 14</p>
---	---	---	---

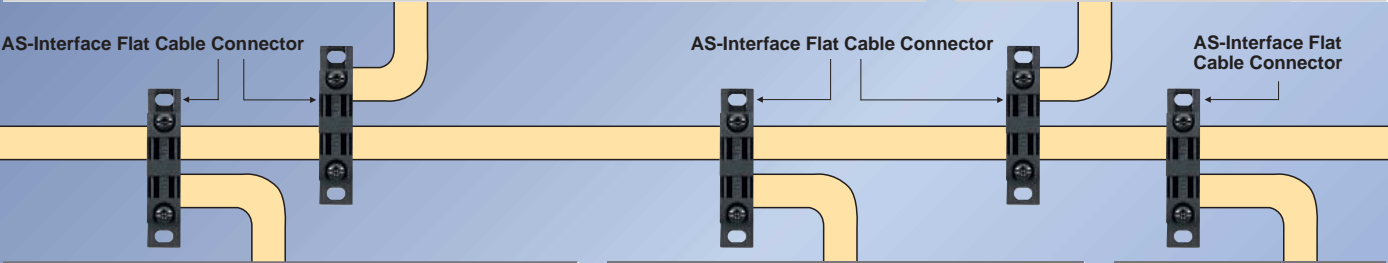

**AS-Interface Communication Terminal Outside-panel Type IP67**



**4 inputs / 2 outputs**

**3 model**      ➔ Page 22

**AS-Interface Communication Terminal Inside-panel Type IP20**



**4 inputs / 3 outputs**

**2 model**      ➔ Page 23

**FL1C IDEC SmartRelay**



**AS-Interface Master Module**  
 Type No.: FC4A-AS62M  
 Applicable CPU modules: FC4A-D20RK1, FC4A-D20RS1, FC4A-D40K3, FC4A-D40S3  
 Applicable slaves: Digital and analog slaves (62 maximum)

**AS-Interface Communication Terminal**  
 Outside-panel type I/O modules  
 Type No.: SX5A-SWN40S02 (4 inputs)  
           SX5A-SWN40K02N (4 inputs)  
           SX5A-SWM22KS2N (2 inputs / 2 outputs)  
           SX5A-SWM43KS2N (4 inputs / 3 outputs)  
 Degree of protection: IP67  
 I/O spec: 4 NPN inputs (for 2- and 3-wire sensors)  
           4 PNP inputs (for 2- and 3-wire sensors)  
           2 PNP inputs (for 2- and 3-wire sensors), 2 PNP outputs  
           4 PNP inputs (for 2- and 3-wire sensors), 3 PNP outputs  
 Wiring style: M12 connector  
 Used with an optional base module.

**AS-Interface Power Supply**  
 Type No.: PS2R-Q30ABL (73W)  
           PS2R-F30ABL (145W)  
 Rated input voltage: 100 to 240V AC  
 Rated output voltage: 30.5V DC (AS-Interface)  
 Rated output current: 2.4A (73W), 4.8A (145W)

**AS-Interface Communication Terminal**  
 Inside-panel type I/O modules  
 Type No.: SX5A-SSN40S0N (4 inputs)  
           SX5A-SSN40K0N (4 inputs)  
           SX5A-SSM43KSN (4 inputs / 3 outputs)  
 Degree of protection: IP20  
 I/O spec: 4 NPN inputs (for 2- and 3-wire sensors)  
           4 PNP inputs (for 2- and 3-wire sensors)  
           4 PNP inputs (for 2- and 3-wire sensors), 3 PNP outputs  
 Wiring style: Screw terminal block

# the world with reduced wiring

## SwitchNet Control Units directly connect to AS-Interface

Intelligent panels can be built with substantially reduced wiring at a lower total cost.

- Signals and power are carried through two wires.
- A maximum of 62 switches and pilot lights can be connected. The wire length can be extended to 300m by using two repeaters.
- Spring clamp terminals save wiring time greatly.

Intelligent pilot lights and illuminated pushbuttons enable brightness control.

The brightness can be controlled in four levels according to the command from the AS-Interface master transmitted through the AS-Interface. More dynamic display and energy savings are made possible.

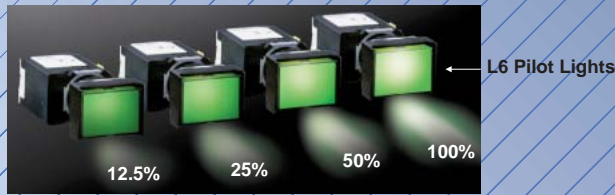

Each control switch or pilot light contains a communication IC (ASI-SW: AS-Interface Ver. 2.1).

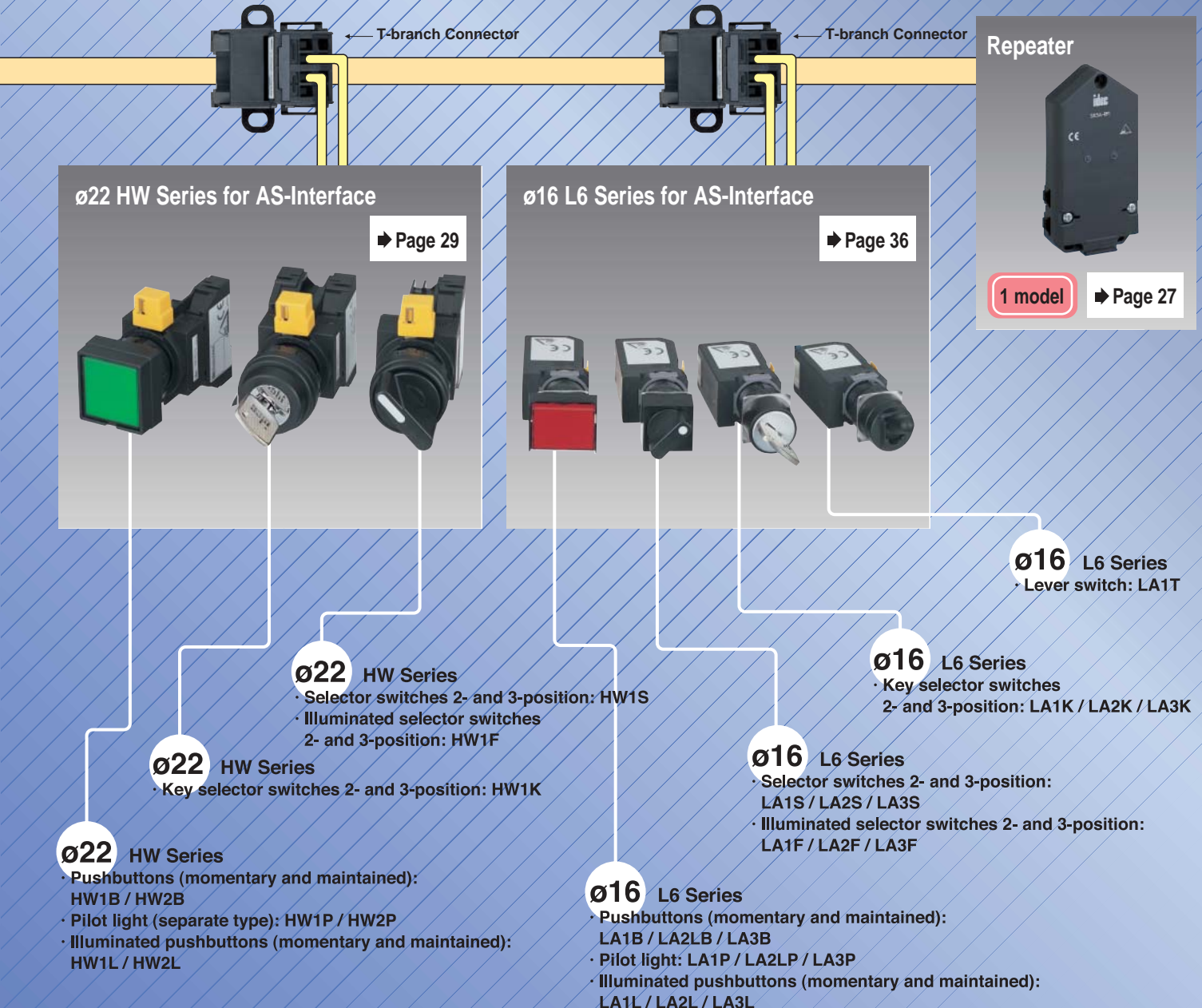

## Quick and secure connection

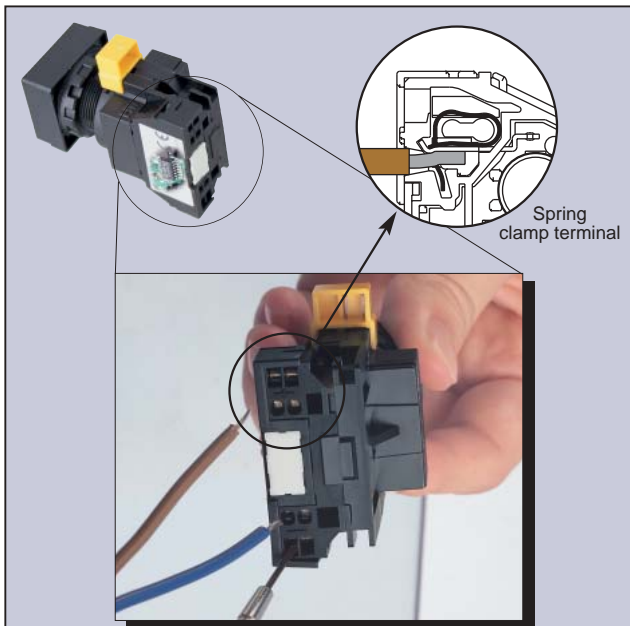

**Spring clamp reduces wiring time**  
SwitchNet control units feature spring clamp terminals, eliminating the need for tightening screws. Wiring time is substantially reduced.

## Easy wiring

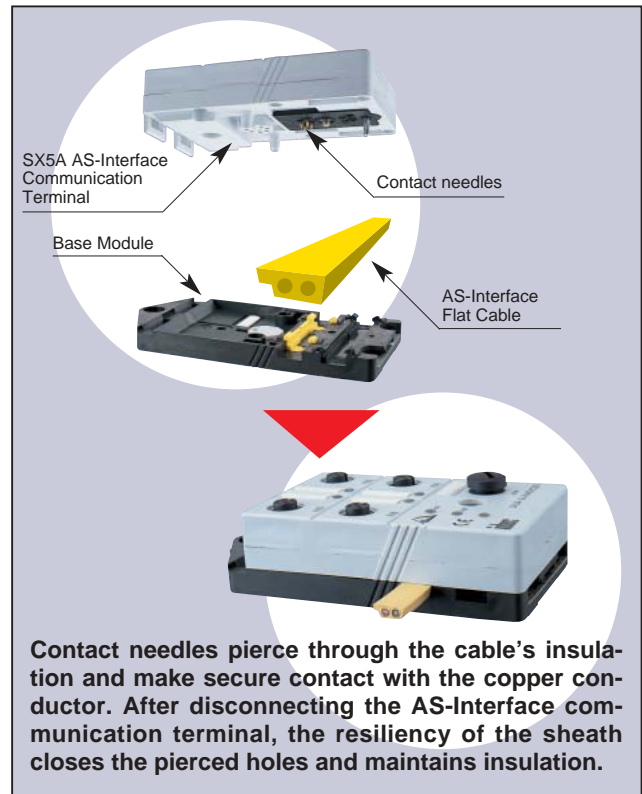

## Flexible Network Topology

The AS-Interface network structure can be selected from various types of topology to meet application requirements for slave locations and cable branching.

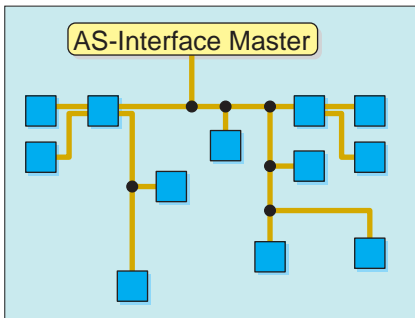

Tree structure

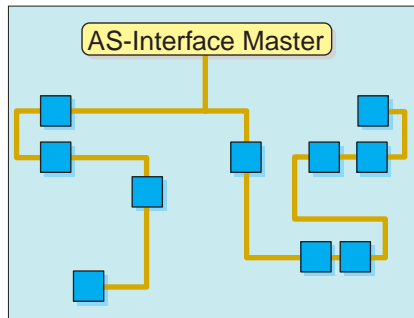

Line structure

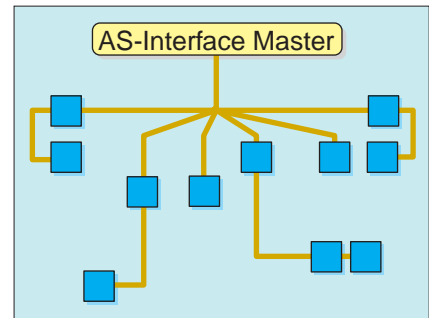

Star structure

■ AS-Interface slave  
AS-Interface power supply can be connected at any place. No terminator is needed.

Three types of connectors are available for easy designing of the inside- and outside-panel layout.

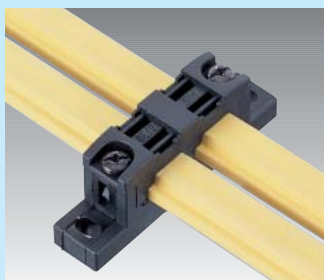

AS-Interface Flat Cable Branch Connector (IP65)



M12 Branch Connector (IP65)

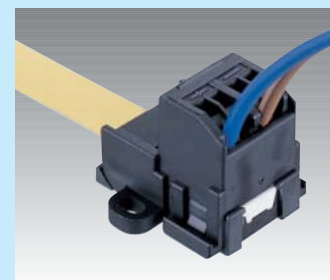

T-branch Connector (IP20)

## Compliant with AS-Interface Ver. 2.1

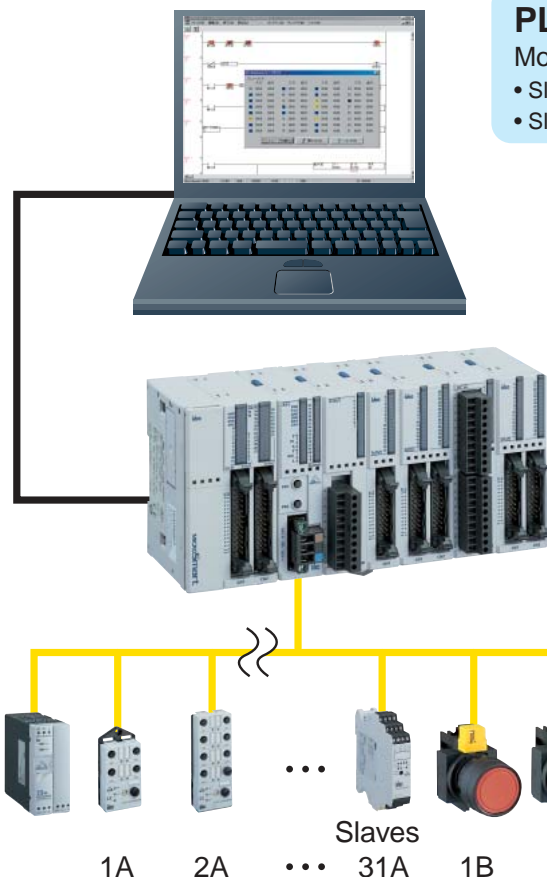

### PLC Programming Software: WindLDR Ver 4.21

Monitor function

- Slave configuration
- Slave I/O statuses

### MicroSmart AS-Interface Master Module

In addition to the control by the MicroSmart CPU module, the AS-Interface master module can also perform various configuration and monitoring functions using the pushbuttons and LED indicators on the front.

- SwitchNet™ illumination brightness can be controlled in four levels: 100%, 50%, 25%, 15%
- Monitoring slave I/O statuses
- Automatic slave address assignment when replacing slaves
- Changing slave addresses when adding slaves
- Configuring slaves
- Switching between protected mode (operation mode) and configuration mode

AS-Interface Ver. 2.1 Compliant

## 62-slave mode compatible

434 I/O points maximum can be controlled.

### AS-Interface Ver. 2.1 and Ver. 2.0 Comparison

Master and slaves of either AS-Interface Ver. 2.1 or Ver. 2.0 can be connected to one AS-Interface network. Specifications are subject to the combination.

Master Version	Ver. 2.1	Ver. 2.0
Maximum Slave Quantity	62 (Note)	31
Ver. 2.1 slaves	Ver. 2.1 functionality available	Up to Ver. 2.0 functionality available
Ver. 2.0 slaves	Up to Ver. 2.0 functionality available	Up to Ver. 2.0 functionality available

Note: When using a Ver. 2.1 master with Ver. 2.0 slaves, one slave occupies two slave addresses, and the maximum slave quantity is reduced to 31.

### AS-Interface Main Specifications

Master Version	Ver. 2.1	Ver. 2.0
Control Method	Master/slave	
Topology	Line structure, tree structure, star structure	
Transmission Medium	AS-Interface flat cable (2-wire parallel cable is also applicable)	
Maximum Current within Network	8A per network	
Maximum Slave Quantity	62	31
Maximum I/O Points	434 points (A/B slaves)	248 points (standard slaves)
Maximum Network Length	100m (expandable to 200m using one repeater, or 300m using two repeaters)	
Bus Scan Cycle	10 ms maximum (when connecting 62 A/B slaves)	5 ms maximum (when connecting 31 standard slaves)

### Self-diagnostic Functions of AS-Interface

- Communication error
- Peripheral error detection notices errors on slaves
- Power supply failure

The diagnostic functions help locate and solve errors. These communication errors are reported on the fault LED indicator.

### AS-Interface Maximum Communication Distances

Maximum communication distance (without repeater) = 100m  
 Expandable distance by adding one repeater = 100m  
 Expandable distance by adding one repeater = 100m

Maximum communication distance (with 2 repeaters) = 300m

### AS-Interface Communication Speed

When 62 slaves are connected to the AS-Interface network, data refresh is completed in 10 ms.

- When connecting 31 slaves, maximum scan time is 5 ms.
- When connecting 62 slaves, maximum scan time is 10 ms.

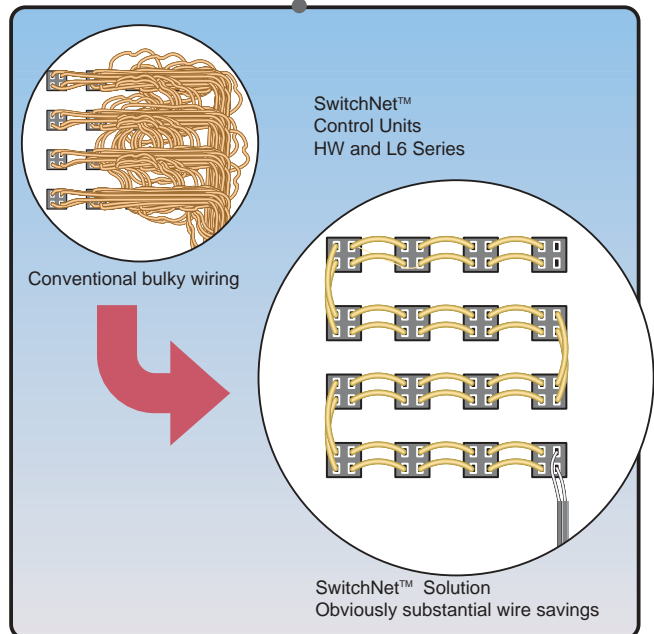
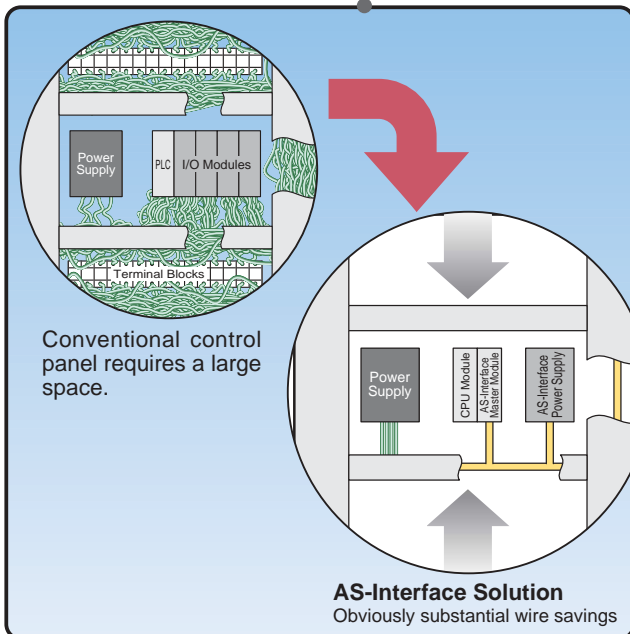
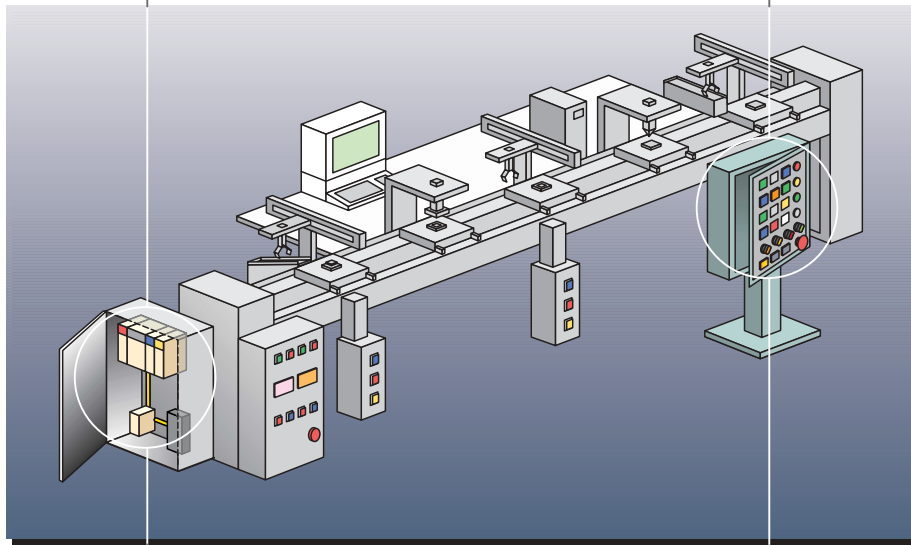
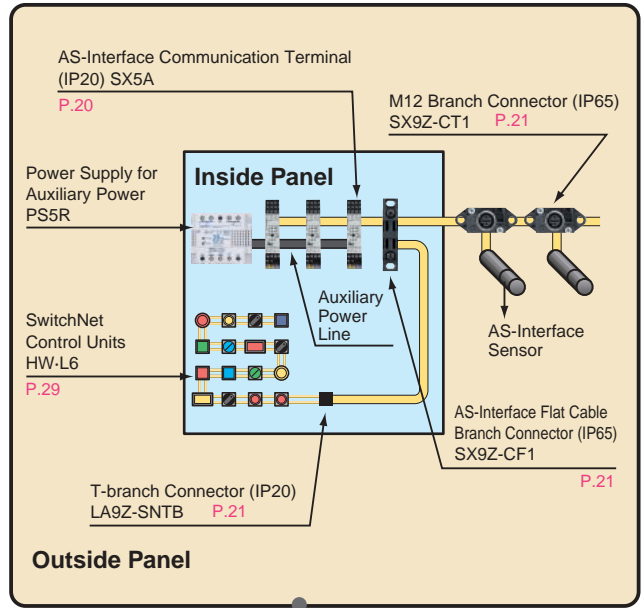
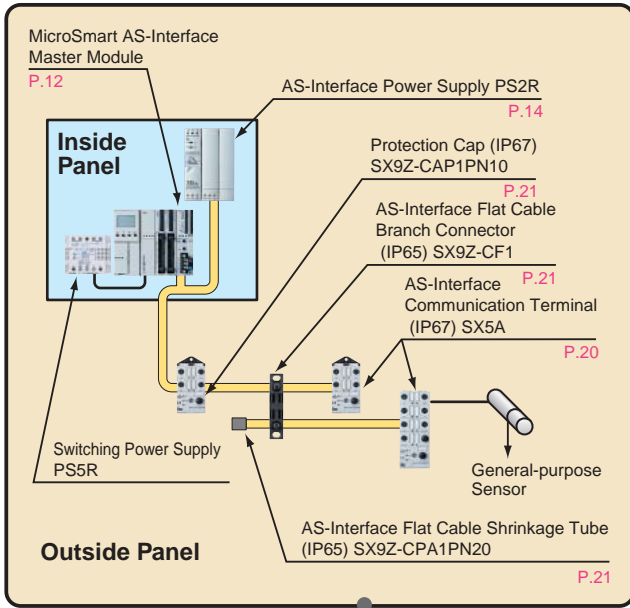



## Example of inside-panel wiring: Total cost savings by about 1/3

### Comparison of Wiring Method (IDEC's products)

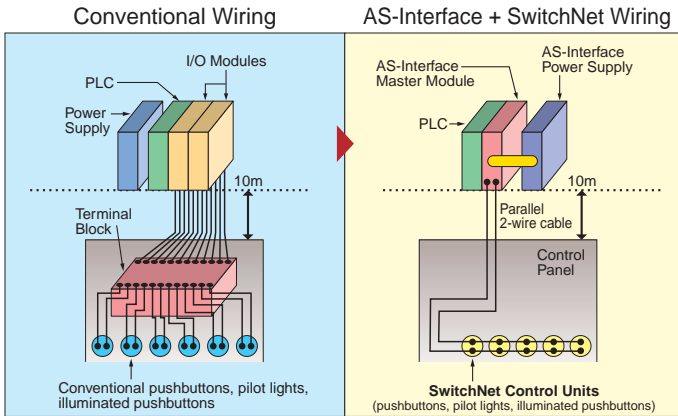

### Conventional Wiring

When using the conventional wiring method involving a PLC and terminal blocks, inside the control panel is filled with wires for control switches, pilot lights, and other devices. Approximately a half of the total panel building cost is accountable to labor cost for wiring.

### AS-Interface + SwitchNet Wiring

All SwitchNet control units are connected to the AS-Interface master module using 2-wire cables. Wiring time drops to approximately 1/4 of the conventional method, and the total cost is reduced by approximately 40%. In addition, maintenance work is also simplified greatly.

### Comparison of Costs (IDEC's products)

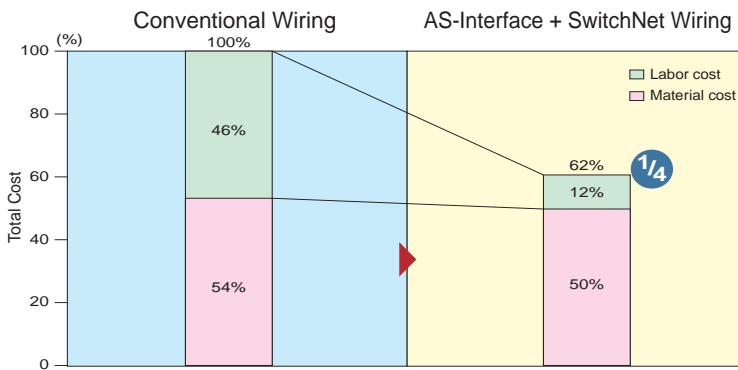

The comparison is based on a simulated control panel configuration consisting of 60 control units.

## Example of inside- and outside-panel wiring: Total cost savings by about 1/4

### Comparison of Wiring Method (IDEC's products)

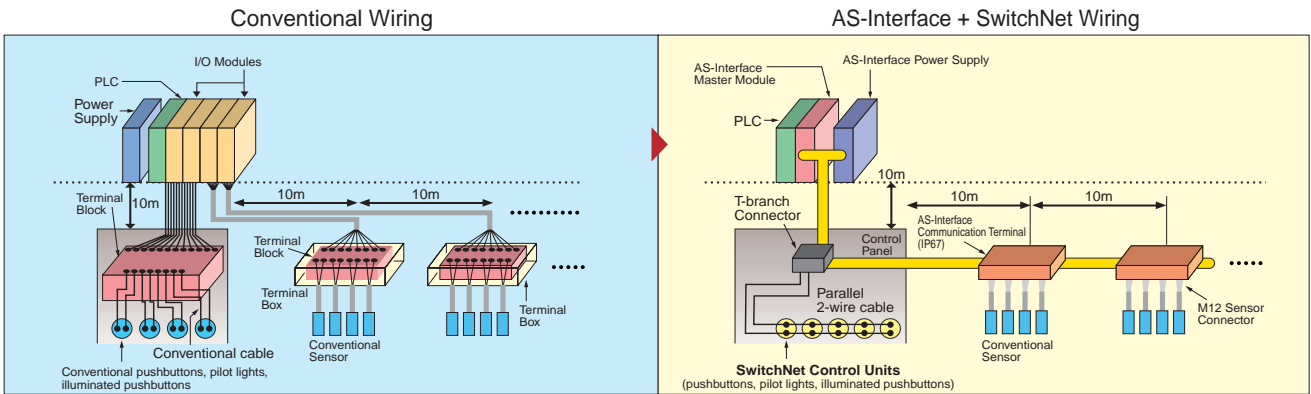

### Comparison of Costs (IDEC's products)

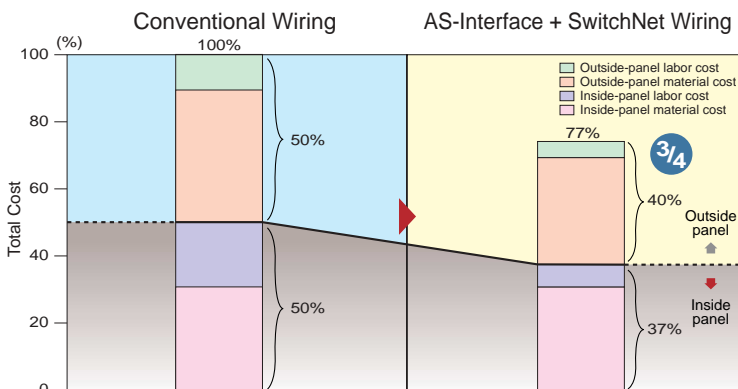

The comparison is based on a simulated control panel configuration consisting of 60 control units.

### Conventional Wiring

A large amount of cost and space are required by the wiring to and inside the terminal boxes.

### AS-Interface + SwitchNet Wiring

SwitchNet wiring reduces the cost for inside-panel wiring, resulting in total cost reduction by approximately 1/4.

## FC4A Series MICROSmart AS-Interface Master Module: FC4A-AS62M

See Page 12



For details about the MicroSmart, see a separate brochure.



- AS-Interface Ver. 2.1 compliant
  - Digital and analog slaves can be connected.
  - Master profile: M1e
  - 23.5-mm-wide compact housing
  - Applicable CPU modules: 20-I/O relay output slim types and 40-I/O slim types
- Type No.: FC4A-D20RK1, FC4A-D20RS1, FC4A-D40K3, FC4A-D40S3

## PS2R AS-Interface Power Supply

See Page 14

73W



PS2R-Q30ABL  
Output capacity 73W  
(30.5V, 2.4A)

145W



PS2R-F30ABL  
Output capacity 145W  
(30.5V, 4.8A)

- AS-International Association certified
- UL, CSA, TÜV Rheinland approved
- CE marked
- Universal AC input: 85 to 264V AC

## FL1C IDEC SmartRelay AS-Interface Communication Module FL1B-CAS2

### FL1B-CAS2



- AS-Interface Ver. 2.0 compliant
- A maximum of 31 slaves can be connected.
- I/O points: 4 input points, 4 output points.
- The space-saving, labor-saving, and cost-saving intelligent relay achieves decentralized control.

### FL1C IDEC SmartRelay

- Parameter values can be changed using buttons.
- I/O points expandable to 24 digital inputs, 16 digital outputs, and 8 analog inputs using expansion I/O modules (4 I/O modules + 4 analog modules maximum).
- AS-Interface and LONWORKS® communication modules achieve decentralized control.
- 10A output. No external relay required.
- A maximum of 130 function blocks and 24 internal relays can work at the same time.



Cat. No. EP1049-0  
For details about the FL1C IDEC SmartRelay, see the catalog.

## SX5A AS-Interface Communication Devices

See Page 16 to 28

### Gateways

#### AS-Interface / CC-Link Gateway



SX5A-GM1N

- AS-Interface Ver. 2.1 compliant
- Degree of protection: IP65
- For connecting AS-Interface to CC-Link
- Power is supplied from AS-Interface.
- Status and error indication on LEDs and 2-digit display

#### AS-Interface / DeviceNet Gateway



SX5A-GD1N

- AS-Interface Ver. 2.1 compliant
- Degree of protection: IP20
- For connecting AS-Interface to DeviceNet
- Power is supplied from the AS-Interface.
- Status and error indication on LEDs and color graphical display

### Repeater



SX5A-RP1

- No address setting required
- AS-Interface network can be extended up to 300 m.
- IP65 protection
- Input statuses of AS-Interface 1 and 2 are displayed with the LED indicators.

### SX5A AS-Interface Communication Terminal (Outside-panel Type)



SX5A-SWN40S02\*  
SX5A-SWN40K02N  
(4 inputs)



SX5A-SWM22KS2N  
(2 inputs / 2 outputs)



SX5A-SWM43KS2N  
(4 inputs / 3 outputs)

- Degree of protection: IP67, connector type
- Expansion slave addresses up to 62 in the A/B slave mode
- Compatible with 2- and 3-wire sensors (\* up to 31 slaves)
- With AS-Interface power and I/O status indicators
- Overload detection on the sensor power supply
- Output overload detection (2 in/2 out type, 4 in/3 out type)

### SX5A AS-Interface Communication Terminal (Inside-panel Type)



SX5A-SSN40S0N  
SX5A-SSN40K0N  
(4 inputs)



SX5A-SSM43KSN  
(4 inputs / 3 outputs)

- Degree of protection: IP20, terminal block type
- Expansion slave addresses up to 62 in the A/B slave mode
- Detachable terminal block
- Communication monitor function
- Compatible with 2- and 3-wire sensors
- Input port power can be selected to supply from inside or outside
- With AS-Interface power, auxiliary power, and I/O status indicators

# SwitchNet™

- Control switches and pilot lights containing ASI-SW, a new AS-Interface communication IC, with IP65 degree of protection.
- The HW series for ø22mm mounting holes are available in 216 models, and the ø16 L6 series in 277 models — a total of 493 models to choose from.
- Spring clamp terminals substantially reduce wiring time.
- Illuminated units can change the brightness in four levels:

100%, 50%, 25%, and 12.5%.

- The same panel layout (mounting centers and behind-panel depth) can be used as the conventional HW and L6 series.

Mounting Hole	Series	Minimum Mounting Centers (W × H)	Behind-panel Depth
ø22	HW series	30.0 × 50.0 mm (Note 1)	49.3 mm
ø16	L6 series	24.0 × 18.0 mm (Note 2)	43.8 mm

Note 1: 30.0 × 50.0 mm for ø40 mushroom buttons

Note 2: Same mounting centers for round, square, and rectangular units.

## HW Series (ø22mm mounting hole) See Page 29

Non-illuminated Pushbuttons					
Round Flush	Round Extended	ø29 Mushroom	ø40 Mushroom	Square Flush	Square Extended
I/O: 1 in, momentary and maintained operation					
Illuminated Pushbuttons					
Round Flush	Round Extended	Round Extended with Full Shroud	ø29 Mushroom	ø40 Mushroom	Square Flush
I/O: 1 in/1 out, momentary and maintained operation					
Pilot Lights		Selector Switch	Key Selector Switch	Illuminated Selector Switch	
Round Flush	Square Flush	Knob Operator	Key Operator		
I/O: 1 out		I/O: 1 in (2-position) 1 in + 1 in on 2 slaves (3-position)		I/O: 1 in/1 out (2-position) 1 in/1 out + 1 in on 2 slaves (3-position)	

## L6 Series (ø16mm mounting hole) See Page 36

Non-illuminated Pushbuttons			Illuminated Pushbuttons		
Round	Square	Rectangular	Round	Square	Rectangular
I/O: 1 in, momentary and maintained operation			I/O: 1 in/1 out, momentary and maintained operation		
Pilot Lights			Selector Switches		
Round	Square	Rectangular	Round	Square	Rectangular
I/O: 1 out			I/O: 1 in (2-position), 2 in (3-position)		
Key Selector Switches			Illuminated Selector Switches		
Round	Square	Rectangular	Round	Square	Rectangular
I/O: 1 in (2-position), 2 in (3-position)			I/O: 1 in/1 out (2-position), 2 in/1 out (3-position)		
Lever Switch					
I/O: 1 in (2-position), 2 in (3-position)					

# MicroSmart AS-Interface Master Module

## Capable of Connecting 62 Slaves using a Two-wire Cable

- Compliance with AS-Interface Ver. 2.1 specifications
- Digital and analog slaves can be connected.
- Configuration and slave monitoring can be done using the LED indicators and pushbuttons on the front panel as well as using WindLDR.
- The master profile is compliant with the entire specifications of M3.
- The AS-Interface master module can be used with 20-I/O relay output slim type CPU modules (FC4A-D20RK1 and FC4A-D20RS1) and 40-I/O slim type CPU modules (FC4A-D40K3 and FC4A-D40S3).
- The CPU module can control a maximum of 634 I/O points: digital I/O points 200 plus AS-Interface slave I/O points 434.
- When an AS-Interface master module is mounted, five more I/O modules can be added.
- The CPU module functionality can be expanded using optional clock cartridge and memory cartridge.
- The CPU module has an RS232C port as standard, and another RS232C or RS485 port can be added using an optional communication adapter or communication module.
- Analog signals can also be processed using the built-in analog voltage input terminal or optional analog I/O modules.
- IEC62026-2 compliant.

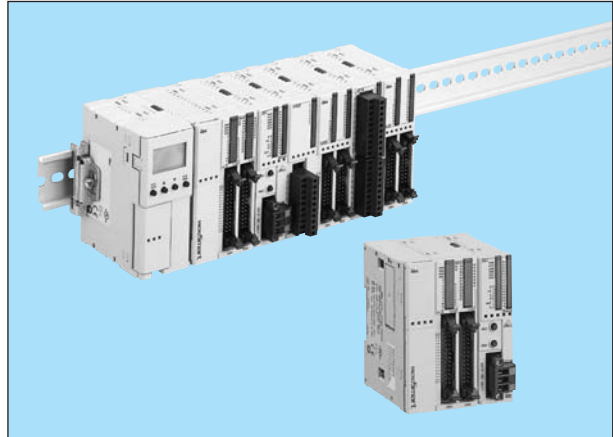





## Types

### • AS-Interface Master Module

Name & Appearance	Type No.	Package Quantity
MicroSmart AS-Interface Master Module 	FC4A-AS62M	1

### • CPU Modules compatible with AS-Interface Master Module

Name & Appearance	Power Voltage	Input Type	Output	High-speed Transistor Output	I/O Points	Type No.	Package Quantity
Slim Type 	24V DC	24V DC Sink/source	Relay 2A 240V AC/2A 30V DC/2A	Sink 0.3A	20 points (12 in / 8 out) *	FC4A-D20RK1	1
Slim Type 				Source 0.3A		FC4A-D20RS1	
Slim Type 			Transistor sink output 0.3A	40 points (24 in / 16 out)	FC4A-D40K3		
Slim Type 			Transistor source output 0.3A		FC4A-D40S3		





Note \*: Two points are transistor outputs, and six points are relay outputs.

### • Programming and Monitoring Software

Name & Appearance	Type No.	Package Quantity
WindLDR (Ver. 4.21 or higher) 	FC9Y-LP2CDW	1

# MicroSmart AS-Interface Master Module

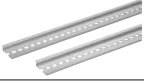
## • Accessories

Name & Appearance	Description	Type No.	Ordering Type No.	Package Quantity
Terminal Block for AS-Interface Master Module 	3-pole	FC4A-PMT3	FC4A-PMT3PN02	2
Direct Mounting Strip 	For direct panel mounting	FC4A-PSP1	FC4A-PSP1PN05	5
35-mm-wide DIN Rail 	Aluminum (1m long)	BAA1000	BAA1000PN10	10
	Steel (1m long)	BAP1000	BAP1000PN10	10
Mounting Clip 		BNL5	BNL5PN10	10
AS-Interface Master Module User's Manual 		FC9Y-B644	FC9Y-B644	1

Note: When ordering, specify the Ordering Type No.

## Specifications (AS-Interface Master Module)

### • General Specifications

Operating Temperature	0 to 55°C (no freezing)
Storage Temperature	-25 to +70°C (no freezing)
Relative Humidity	Level RH1, 30 to 90% (non-condensing)
Pollution Degree	2 (IEC 60664)
Degree of Protection	IP20
Corrosion Immunity	Atmosphere free from corrosive gases
Altitude	Operation: 0 to 2000m Transport: 0 to 3000m
Vibration Resistance	<ul style="list-style-type: none"> <li>When mounted on a DIN rail: 10 to 57 Hz amplitude 0.075 mm, 57 to 150 Hz acceleration 9.8 m/s<sup>2</sup> 2 hours per axis on each of three mutually perpendicular axes</li> <li>When mounted on a panel surface: 2 to 25 Hz amplitude 1.6 mm, 25 to 100 Hz acceleration 39.2 m/s<sup>2</sup> 90 minutes per axis on each of three mutually perpendicular axes</li> </ul>
Shock Resistance	147 m/s <sup>2</sup> , 11 ms duration, 3 shocks on each of three mutually perpendicular axes (IEC 61131)

### • Function Specifications

External Power Supply	AS-Interface power supply, 29.5 to 31.6V DC
AS-Interface Current Draw	65 mA (normal operation) 110 mA maximum
Effect of Improper Input Connection	No damage
Connector on Mother Board	MSTB2.5/3-GF-5.08BK (Phoenix Contact) Insertion/removal durability: 100 times minimum
Internal Current Draw	80 mA (5V DC)
AS-Interface Master Module Power Consumption	540 mW (24V DC)
Weight (approx.)	85g

### • Communication Specifications

Maximum Bus Cycle	When 1 through 19 slaves are connected: 3 ms When 20 through 62 slaves are connected: 0.156 × (1 + N) ms where N is the number of active slaves 5 ms maximum when 31 slaves are connected 10 ms maximum when 62 slaves are connected
Maximum Slaves	Standard slaves: 31 A/B slaves: 62
Maximum I/O Points	Standard slaves: 248 total (124 inputs + 124 outputs) A/B slaves: 434 total (248 inputs + 186 outputs)
AS-Interface Cable Maximum Length	When using no repeater or extender: 100m When using a total of 2 repeaters or extenders: 300m
Rated Bus Voltage	30V DC

## Dimensions

### • FC4A-AS62M

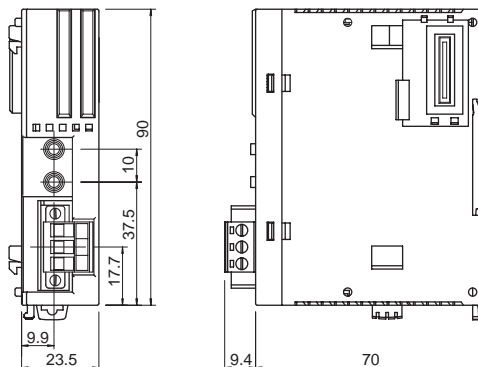

All dimensions in mm.

# PS2R AS-Interface Power Supply



## AS-Interface Power Supply with Universal AC Input Voltage

- Input voltage range: 100 to 240V AC
- Two output ratings: 73W and 145W
- Slim housing style mountable on DIN rails
- IP20 finger-safe terminals
- CE marked (LVD, EMC)
- UL listed (UL 508), CSA (No. 950), TÜV (EN 60950, EN61010-1)
- Noise standards EN 55022, EN 61000-6-2 compliant
- I/O terminals are separated to top and bottom for easy wiring.
- With input indicator (orange) and output indicator (green)
- Mountable on 35-mm-wide and 75-mm-wide DIN rails
- IEC62026-2 compliant





## Types

### • AS-Interface Power Supply

Name & Appearance	Output Capacity	Input Voltage	Output Voltage	Type No.	Package Quantity
AS-Interface Power Supply 	73W	100 to 240V AC	30.5V DC	PS2R-Q30ABL	1
AS-Interface Power Supply 	145W			PS2R-F30ABL	

### • Accessories

Name & Appearance	Description	Type No.	Ordering Type No.	Package Quantity
35-mm-wide DIN Rail 	Aluminum (1m long)	BAA1000	BAA1000PN10	10
	Steel (1m long)	BAP1000	BAP1000PN10	10
Mounting Clip 		BNL5	BNL5PN10	10

Note: When ordering, specify the Ordering Type No.

## Specifications

### • AS-Interface Power Supply

Type No.	PS2R-Q30ABL	PS2R-F30ABL			
Input	Efficiency		83% (typical) at the rated input/output		
	Voltage		100 to 240V AC (85 to 264V AC)		
	Frequency		47 to 63 Hz		
	Current	100V AC	1.8A (typical) at the rated load	3.0A (typical) at the rated load	
		220V AC	1.0A (typical) at the rated load	2.0A (typical) at the rated load	
	Leakage Current		3.5 mA maximum (UL, CSA, VDE)		
Inrush Current		30A maximum (25°C at cold start)			
Output	Rated Voltage		30.5V DC		
	Rated Current		2.4A	4.8A	
	Adjustable Voltage Range		Fixed		
	Ripple Noise Voltage		300 mV p-p maximum (0 to 10 kHz), 50 mV p-p maximum (10 to 500 kHz) according to AS-Interface standard		
	Input/Load Fluctuation		3%		
	Overall Fluctuation		29.5 to 31.6V DC including input fluctuation, output fluctuation, temperature fluctuation, and ripple voltage		
	Delay Time		2 sec maximum (delay in output voltage change from 5V to 26.5V) according to AS-Interface standard		
	Startup Time		1 sec maximum (output voltage change from 21.5V to 29.5V) according to AS-Interface standard		
Output Holding Time		10 ms minimum at 85V AC, rated load			

# PS2R AS-Interface Power Supply

Type No.		PS2R-Q30ABL	PS2R-F30ABL
Supplementary Functions	Overcurrent Protection	110% (typical), automatic reset (Note 1)	
	Overvoltage Protection	120% minimum (Note 2)	
	Undervoltage Protection	95% maximum, automatic reset	
	Input Indicator	Orange	
	Output Indicator	Green	
Dielectric Strength		Between inputs and outputs: 3.0 kV AC, 1 minute Between inputs and ground: 3.0 kV AC, 1 minute Between outputs and ground: 0.5 kV AC, 1 minute	
Insulation Resistance		Between inputs and outputs: 100 MΩ minimum (500V DC megger) Between inputs and ground: 100 MΩ minimum (500V DC megger)	
Operating Temperature		0 to 60°C (See the derating curve.) Vertical mounting only	
Storage Temperature		-25 to +70°C (no freezing, non-condensation)	
Operating Humidity		95% RH (non-condensation)	
Vibration Resistance		10 to 57 Hz amplitude 0.075 mm, 57 to 150 Hz acceleration 10 m/s <sup>2</sup> 10 cycles per axis on each of three mutually perpendicular axes	
Shock Resistance		147 m/s <sup>2</sup> , 11 ms duration, 2 shocks per axis, on six mutually perpendicular axes	
Terminal		IP20	
Weight (approx.)		800g	1300g
Dimensions		120H × 54W × 120D mm	120H × 81W × 120D mm
Safety Standards		UL 508 listed CSA C22.2 No. 950 EN 60950, EN 61010	
AS-Interface Standard		EN 50295	
EMC	(EMI) Radiated Emission	IEC 61000-6-2 EN 55022 class B	
	Conducted Emission	EN 55022 class B	

Note 1: The AS-Interface power supply is provided with an overvoltage protection circuit, but a long period of overload and short-circuit should be averted.  
Note 2: After turning off the input voltage, allow more than 10 seconds before turning on again.

## Block Diagram

- PS2R-Q30ABL
- PS2R-F30ABL

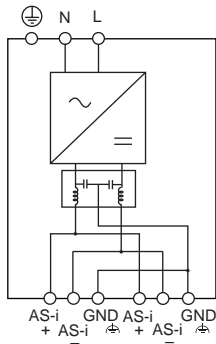

## Output Derating

(Operating temperature is the temperature around the power supply)

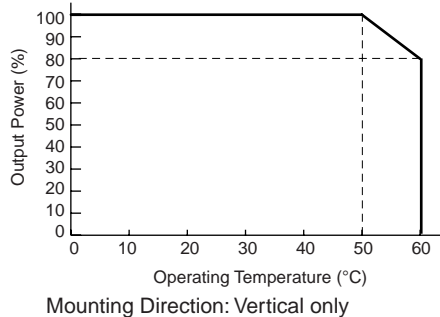

## Terminal Names

- ① (L) AC input terminal
- ② (N) AC input terminal (ground side)
- ③ (⊕) Ground terminal (protective ground)
- ④ (AS-i+) AS-Interface + output terminal
- ⑤ (AS-i-) AS-Interface - output terminal
- ⑥ (⊖) Ground terminal (output side)
- ⑦ (-) Input indicator (goes on when input is on)
- ⑧ (AS-i) Output indicator (goes on when output is on)

- PS2R-Q30ABL

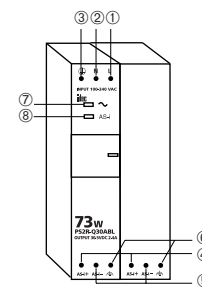

- PS2R-F30ABL

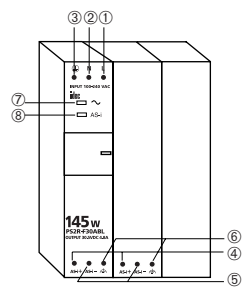

## Dimensions

- PS2R-Q30ABL

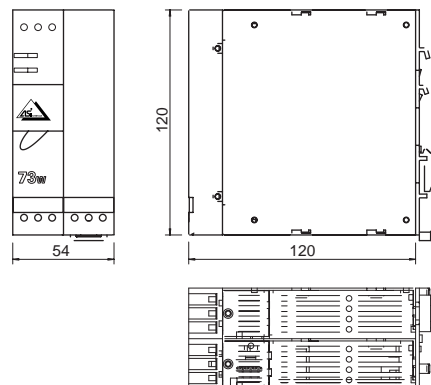

- PS2R-F30ABL

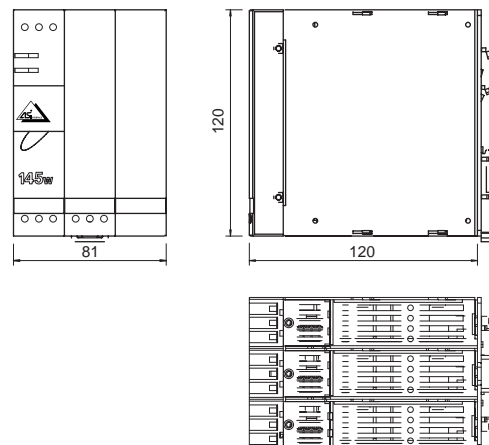

All dimensions in mm.

# SX5A AS-Interface Gateway

## AS-Interface/CC-Link Gateway

### SX5A-GM1N

- The SX5A-GM1N gateway converts the CC-Link and AS-Interface protocols. Serves as a slave of CC-Link and a master of AS-Interface.
- AS-Interface Ver. 2.1 compliant
- Degree of protection: IP65
- AS-Interface can be connected to CC-Link.
- Power is supplied from AS-Interface.
- Status and error indication on LEDs and 2-digit display
- All AS-Interface functions can be operated via CC-Link.



## Specifications

Type No.		SX5A-GM1N	
General Specifications	Rated Input Voltage	26.5 to 31.6V DC	
	Rated Current	200 mA	
	Operating Temperature	0 to +55°C (no freezing)	
	Storage Temperature	-25 to +85°C (no freezing)	
	Operating Humidity	30 to 95% RH (no condensation)	
	Degree of Protection	IP65	
	Insulation Resistance	5 MΩ minimum (500V DC megger)	
	Dielectric Strength	1000V AC, 1 minute	
	Applicable Wire	AS-Interface	AS-Interface flat cable
		CC-Link	3-wire twisted pair cable
	Weight	Approx. 355 g	
Dimensions	95W × 102H × 71D mm		
Mounting	35-mm DIN rail or screw mounting		
Communication Specifications	AS-Interface	Topology	Bus
		Max. Number of Nodes per Network	62
		Max. Number of I/Os per Network	434
		Cycle Time	10 msec (62 slaves)
		Max. Network Length	100 m (AS-Interface flat cable)
		Max. Current inside Network	8A per AS-Interface circuit
		Applicable AS-Interface Version	Version 2.1
	CC-Link	Topology	Bus
		Max. Network Length	100 m (10 Mbps), 150 m (5 Mbps), 200 m (2.5 Mbps), 600 m (625 kbps), 1200 m (156 kbps)
Transmission Speed		10 Mbps, 5 Mbps, 2.5 Mbps, 625 kbps, 156 kbps	
Applicable CC-Link Version	Version 1.0		
Standards		UL/c-UL, CE	

## Front Panel

### • Display

The front panel has 10 LED indicators and a 2-digit display.

### LED Indicators

LED	Color (ON)	Description
PW	Green	Sufficient power is supplied to the gateway.
L RUN	Green	Communication is active via the CC-Link interface.
L ERR	Green	The CC-Link has a communication error.
SD	Green	The CC-Link interface is transmitting data.
RD	Green	The CC-Link interface is receiving data.
CONF ERR	Red	The AS-Interface has a configuration error.
U AS-i	Green	Sufficient power is supplied to the AS-Interface circuit.
AS-i active	Green	Normal operation
PRG ENABLE	Green	Automatic addressing function is enabled.
PRG MODE	Orange	AS-Interface master is in configuration mode.

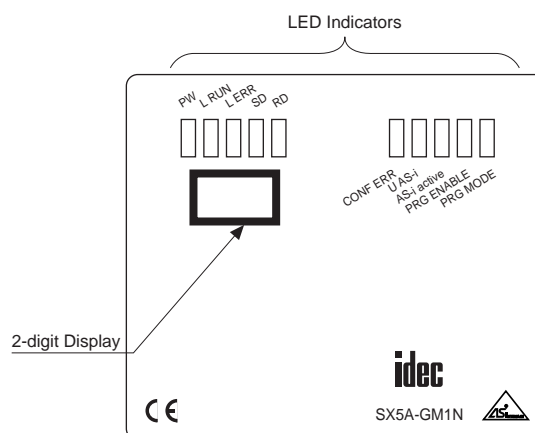



# SX5A AS-Interface Gateway

## Mounting and Removing (DIN Rail)

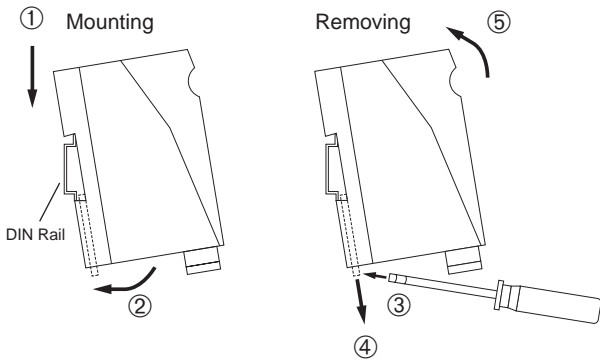

## Dimensions

### • SX5A-GM1N

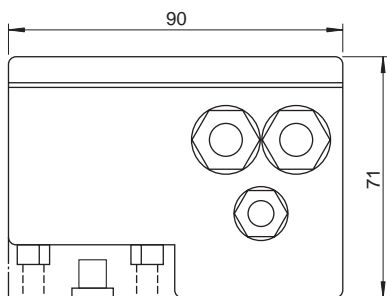
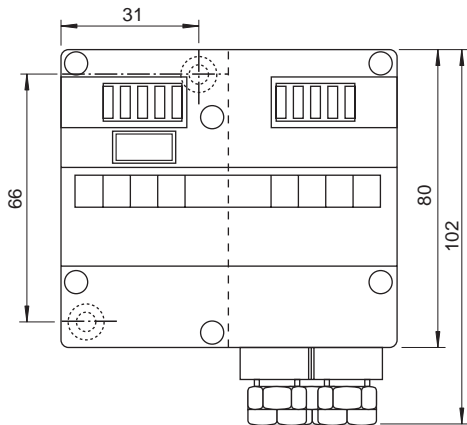

## Mounting Hole Layout

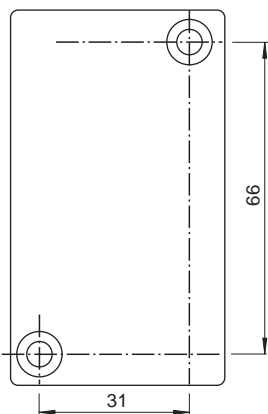

All dimensions in mm.

## Internal Connection

### ① CC-Link Terminals

To connect the SX5A-GM1N gateway to the CC-Link, remove the top cover and connect the CC-Link cable to the screw terminals. After connecting the cable, reinstall the top cover.

1	2	3	4	5
FG	SLD	DG	DA	DB
6	7	8	9	10
FG	SLD	DG	DA	DB



### Terminator

When the SX5A-GM1N is not positioned at the end of the CC-Link line, remove the terminator.

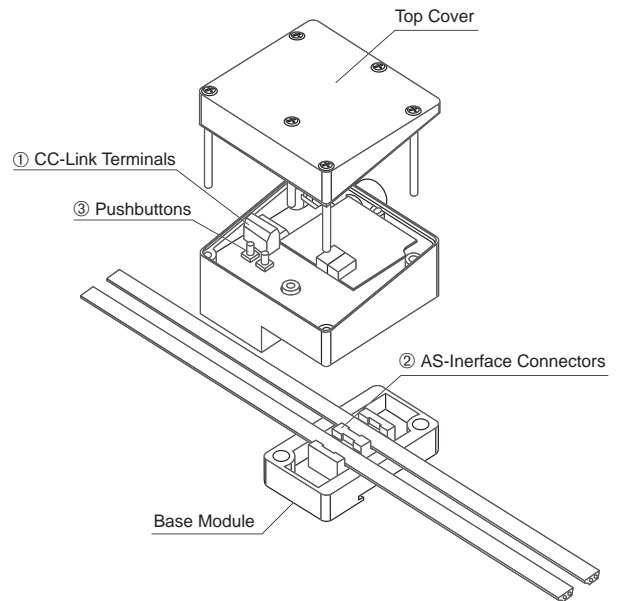

### ② AS-Interface Connectors

Power is supplied to the SX5A-GM1N by connecting to the AS-Interface network via the base module.



### Warning

When connecting only one AS-Interface flat cable, plug the unused cable connector using the attached gasket to ensure waterproof characteristics.

### ③ Pushbuttons

1. Sets the CC-Link slave number and baud rate.
2. Switches to AS-Interface configuration mode and protected mode.

# SX5A AS-Interface Gateway

## AS-Interface/DeviceNet Gateway

### SX5A-GD1N

- The SX5A-GD1N is a gateway to convert the DeviceNet and AS-Interface protocols. Serves as a slave of the DeviceNet and a master of the AS-Interface.
- AS-Interface Ver. 2.1 compliant
- Degree of protection: IP20
- AS-Interface can be connected to the DeviceNet.
- Power is supplied from the AS-Interface.
- Status and error indication on LEDs and color graphical display
- All AS-Interface functions can be operated via DeviceNet.



## Specifications

Type No.		SX5A-GD1N		
General Specifications	Rated Input Voltage	26.5 to 31.6V DC		
	Rated Current	200 mA		
	Operating Temperature	0 to +55°C (no freezing)		
	Storage Temperature	-15 to +70°C (no freezing)		
	Operating Humidity	30 to 95% RH (no condensation)		
	Degree of Protection	IP20		
	Insulation Resistance	100 MΩ minimum (500V DC megger)		
	Dielectric Strength	1000V AC, 1 minute		
	Applicable Wire	AS-Interface	AS-Interface flat cable Stranded wire: 0.5 to 0.75 mm <sup>2</sup> (ferrule) Single wire: 0.5 to 1.5 mm <sup>2</sup> Shield wire outside diameter: 2.8 mm maximum	
		DeviceNet	2-wire twisted pair cable	
Weight	Approx. 420 g			
Dimensions	100W × 75H × 115D mm			
Mounting	35-mm DIN rail or screw mounting			
Communication Specifications	AS-Interface	Topology	Bus	
		Max. Number of Nodes per Network	62	
		Max. Number of I/Os per Network	434	
		Cycle Time	10 ms (62 slaves) (AS-Interface cable)	
		Max. Network Length	100 m AS-Interface flat cable (3V maximum voltage drop on the transmission line)	
		Max. Current inside Network	8A per AS-Interface circuit	
	Applicable AS-Interface Version	Version 2.1		
	DeviceNet	Topology	Bus	
		Max. Network Length	500 m (125 kbps), 250 m (250 kbps), and 100 m (500 kbps)	
		Data Size	Maximum input 64 bits, output 32 bits	
Transmission Speed		125, 250, and 500 kbps		
Applicable DeviceNet Version	Version 2.0 Errate 4			
Standards	UL/c-UL, CE			

# SX5A AS-Interface Gateway

## Front Panel

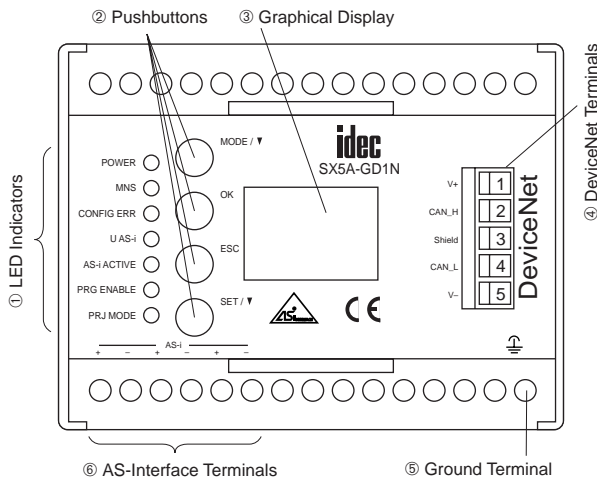

### ① LED Indicators

LED	Color (ON)	Description
POWER	Green	Sufficient power is supplied to the gateway.
MNS	Red/Green	Red flash: No CAN communication in preoperational mode. Green flash: CAN communication node in preoperational mode. Green ON: CAN communication node in operational mode.
CONFIG ERR	Red	Configuration error
U AS-i	Green	Sufficient power is supplied to the AS-Interface circuit.
AS-i ACTIVE	Green	Normal operation
PRG ENABLE	Green	Automatic addressing function is enabled.
PRJ MODE	Orange	AS-Interface master is in configuration mode.

### ② Pushbuttons

MODE	Switches to configuration and protected modes. Saves the AS-Interface configuration data as default settings.
OK, ESC	Switches to graphical mode.
SET	Sets slave address.

### ③ Graphical Display

Using the graphical display, the entire AS-Interface network can be operated without using the DeviceNet master. Connected equipment can be tested completely, ensuring easy and quick operation.

### ④ DeviceNet Terminals

Terminal	Signal	Function	Color
1	V+	DeviceNet Power +	Red
2	CAN_H	Communication Data High	White
3	Shield	Shield	—
4	CAN_L	Communication Data Low	Blue
5	V-	DeviceNet Power -	Black

### ⑤ Ground Terminal

### ⑥ AS-Interface Terminals

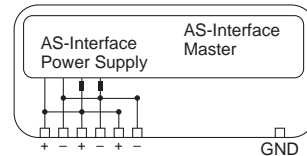

The power to the SX5A-GD1N is supplied from the AS-Interface line (200 mA). No additional 24V DC power is necessary.

The SX5A-GD1N starts when turning on the AS-Interface power.

Terminal	Signal
+	AS-Interface positive terminal (3-pole)
-	AS-Interface negative terminal (3-pole)
GND	Ground

## Mounting and Removing (DIN Rail)

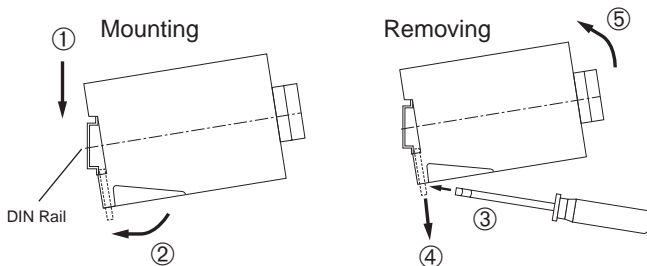

## Mounting Hole Layout

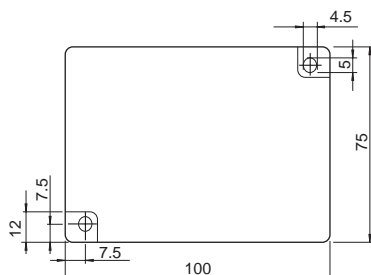

## Dimensions

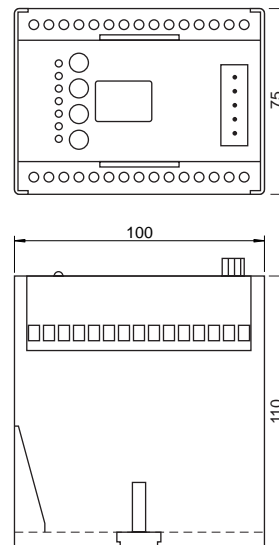

All dimensions in mm.

# SX5A AS-Interface (Communication Terminal and Repeater)

## Available in IP67 and IP20 Types

### AS-Interface Communication Terminals (Slave Modules)

#### IP67 Type I/O Module

- AS-Interface Ver. 2.1 compliant, capable of connecting 62 slaves
- Compatible with 2- and 3-wire sensors
- With AS-Interface power and input status indicators
- Overload detection function on the sensor power supply
- Output overload detection function (2 in/2 out type, 4 in/3 out type)

#### IP20 Terminal Block Type

- AS-Interface Ver. 2.1 compliant, capable of connecting 62 slaves
- Detachable terminal blocks
- Compatible with 2- and 3-wire sensors
- Input port power can be selected to supply from inside or outside.
- AS-Interface power and input status indicators
- IEC62026-2 compliant

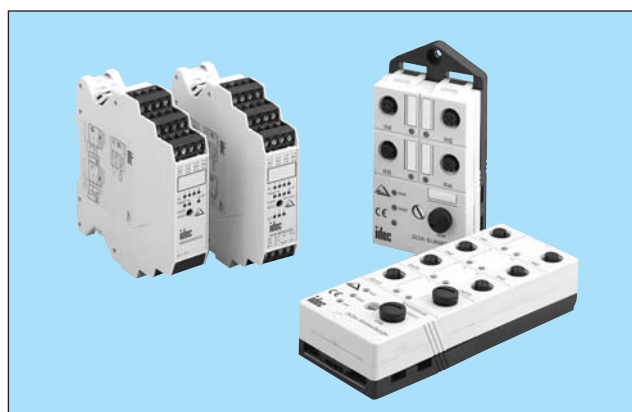



#### Repeater

- No address setting required. The AS-Interface network can be extended up to 300 m.
- IP65 protection
- The piercing technology allows easy connection to AS-Interface flat cables.



## Types

### • SX5A AS-Interface Communication Terminals

Name & Appearance	Terminal	I/O Specifications				Type No.	Package Quantity	Applicable Base Module
		Input Points	Input Type	Output Points	Output Type			
 IP67 Type I/O Module	Connector	4	NPN	—	—	SX5A-SWN40S02	1	SX5A-B3FF
		4	PNP	—	—	SX5A-SWN40K02N	1	SX5A-B3FF
		2	PNP	2	PNP	SX5A-SWM22KS2N	1	SX5A-B3FF
		4	PNP	3	PNP	SX5A-SWM43KS2N	1	SX5A-B2FF
 IP20 Type I/O Module	Terminal Block	4	NPN	—	—	SX5A-SSN40S0N	1	—
		4	PNP	—	—	SX5A-SSN40K0N	1	—
		4	PNP	3	PNP	SX5A-SSM43KSN	1	—

Note: The IP67 type I/O module is not supplied with a base module. Order an applicable base module separately.

### • Base Modules













Name & Appearance	Applicable I/O Module	Description	Type No.	Package Quantity
 Base Module for IP67 Type I/O Module	4 in type 2 in/2 out type	Substructure module to connect two AS-Interface flat cables for AS-Interface bus and auxiliary power	SX5A-B3FF	1
	4 in/3 out type		SX5A-B2FF	1

### • Repeater

Name & Appearance	Description	Type No.	Package Quantity	Note
 Repeater	A repeater can extend the AS-Interface network for up to 100 m.	SX5A-RP1	1	See page 27 for details.

# SX5A AS-Interface (Communication Terminal and Repeater)

## • Accessories

Name & Appearance	Description	Type No.	Ordering Type No.	Package Quantity	Note
 <p>Hand-held Programming Device</p>	Assign slave addresses and monitor system configuration	SX9Z-ADR1N	SX9Z-ADR1N	1	Attachments: <ul style="list-style-type: none"> <li>• Programming device cable (SX9Z-CN1)</li> <li>• Programming device AC adapter (SX9Z-ADPT)</li> <li>• SwitchNet addressing port adapter (LA9Z-SNADP)</li> <li>• Operation manual (English/Japanese)</li> </ul>
 <p>Programming Device Cable</p>	Connect the programming device to slave	SX9Z-CN1	SX9Z-CN1	1	
 <p>Programming Device AC Adapter</p>	Charge the programming device	SX9Z-ADPT	SX9Z-ADPT	1	AC input voltage: 100 to 240V AC
 <p>SwitchNet Addressing Port Adapter</p>	Connect the programming device cable to SwitchNet	LA9Z-SNADP	LA9Z-SNADP	1	
 <p>AS-Interface Flat Cable Branch Connector</p>	Branch AS-Interface flat cable to AS-Interface flat cable	SX9Z-CF1	SX9Z-CF1	1	
 <p>T-branch Connector</p>	Branch AS-Interface flat cable to 2-wire cable	LA9Z-SNTB	LA9Z-SNTB	1	
 <p>M12 Branch Connector</p>	Branch AS-Interface flat cable to M12 connector	SX9Z-CT1	SX9Z-CT1	1	Pin Assignment  1: ASI+ 3: AS- 2: NC 4: NC
 <p>AS-Interface Flat Cable Shrinkage Tube</p>	Protect the end of AS-Interface cable	SX9Z-CPA1	SX9Z-CPA1PN20	20	Degree of protection: IP65
 <p>Protection Cap</p>	Ensure IP67 degree on unused M12 I/O plugs	SX9Z-CAP1	SX9Z-CAP1PN10	10	
 <p>35-mm-wide DIN Rail</p>	Aluminum (1m long)	BAA1000	BAA1000PN10	10	
	Steel (1m long)	BAP1000	BAP1000PN10	10	
 <p>Mounting Clip</p>		BNL5	BNL5PN10	10	

Note: When ordering, specify the Ordering Type No.

# SX5A AS-Interface (Communication Terminal and Repeater)

## IP67 Type I/O Module

- AS-Interface Ver. 2.1 compliant. A maximum of 62 slaves can be connected.
- Only the SX5A-SWN40S02 is a Ver. 2.0 standard slave, which allows for connection of up to 31 slaves.
- Compatible with 2- and 3-wire sensors
- With AS-Interface power and input status indicators
- Overload detection function on the sensor power supply
- Output overload detection function (2 in/2 out type, 4 in/3 out type)
- IEC62026-2 compliant



## Specifications

Type No.	SX5A-SWN40S02		SX5A-SWN40K02N		SX5A-SWM22KS2N		SX5A-SWM43KS2N			
General	Rated Operating Voltage U <sub>e</sub>	26.5 to 31.6V DC supplied from AS-Interface line								
	Rated Operating Current I <sub>e</sub>	≤ 40 mA (without sensor) 240 mA maximum			≤ 40 mA (without sensor) 140 mA maximum		≤ 40 mA (without sensor) 240 mA maximum			
	External Auxiliary Power Supply U <sub>AUX</sub>	—		20 to 30V DC PELV (protective very-low voltage: protection class 3 VDE0106 / IEC 60364-4-41 compliant)						
	Operating Temperature	-25 to +60°C (no freezing)								
	Storage Temperature	-25 to +85°C (no freezing)								
	Degree of Protection	IP67 (EN 60529); Attach the SX9Z-CAP1 protection caps on unused I/O connectors.								
	Connection Method	Insulation penetration technology for flat cables (yellow/black) M12 connector for I/O								
	Weight	100 g	100 g	100 g	150 g					
Mounting Method	Screw mounting on base module									
Input	Input Points/Signals	4 DC inputs 2- and 3-wire sensors (NPN)		4 DC inputs 2- and 3-wire sensors (PNP)		2 DC inputs 2- and 3-wire sensors (PNP)		4 DC inputs 2- and 3-wire sensors (PNP)		
	Input Power	20 to 31V DC supplied from AS-Interface line								
	Load Current Capacity	≤ 200 mA (T <sub>B</sub> ≤ 40°C) ≤ 150 mA (T <sub>B</sub> ≤ 60°C)			≤ 100 mA (T <sub>B</sub> ≤ 40°C) ≤ 75 mA (T <sub>B</sub> ≤ 60°C)		≤ 200 mA (T <sub>B</sub> ≤ 40°C) ≤ 150 mA (T <sub>B</sub> ≤ 60°C)			
		Provided with overload and short-circuit protection								
	OFF Current	OFF ≤ 1 mA		OFF ≤ 2 mA						
	ON Current (sink)	ON ≥ 4.5 mA		ON ≥ 4 mA						
Protection Circuit	Input current limit ≤ 8 mA									
Output	Output Points/Signals	—		2 PNP transistor outputs (with overload/short-circuit protection)		3 PNP transistor outputs (with overload/short-circuit protection)				
	Output Power	—								
	Voltage	—								
	Current	—		1A per output point		2A (OUT1, OUT2) 1.5A (OUT3) 4A total				
	Communication Error	—		Output turns off						
Communication	Slave Type	Standard slave		A/B slave						
	Profile	IO	0		0		B		7	
		ID	1		A		A		A	
		ID2	—		2		2		2	
	Data Bits	Input	Output	Input	Output	Input	Output	Input	Output	
D0	IN1	—	IN1	—	—	OUT1	IN1	OUT1		
D1	IN2	—	IN2	—	—	OUT2	IN2	OUT2		
D2	IN3	—	IN3	—	IN3	—	IN3	OUT3		
D3	IN4	—	IN4	—	IN4	—	IN4	—		
LED Indicators	PWR	AS-Interface power: Green LED								
	AUX	—		External auxiliary power U <sub>AUX</sub> : Green LED						
	IN	4 yellow LEDs			2 yellow LEDs		4 yellow LEDs			
	OUT	—		2 yellow LEDs		3 yellow LEDs				
	FAULT	Error indication: Red LED ON: Communication error or address 0 Flash: Sensor power supply or output is overloaded								
Address Assignment	Addressing Method	Remove the protection cap from the addressing port on the I/O module. Connect the hand-held programming device (SX9Z-ADR1N) to the addressing port on the I/O module using the programming device cable (SX9Z-CN1), then the I/O module stops communication through the AS-Interface line. Change slave address using the programming device.								
Certification	AS-International Association									
Standards	UL/c-UL, CE									

# SX5A AS-Interface (Communication Terminal and Repeater)

## IP20 Type I/O Module

- AS-Interface Ver. 2.1 compliant
- A maximum of 62 slaves can be connected.
- Detachable terminal blocks
- Communication monitor function
- Compatible with 2- and 3-wire sensors
- Input port power can be selected to supply from inside or outside.
- AS-Interface power and input status indicators
- IEC62026-2 compliant



## Specifications

Type No.		SX5A-SSN40S0N	SX5A-SSN40K0N	SX5A-SSM43KSN
General	Rated Operating Voltage $U_e$	26.5 to 31.6V DC supplied from AS-Interface line		
	Rated Operating Current $I_e$	$\leq 30$ mA (without sensor)		$\leq 35$ mA (without sensor)
	External Auxiliary Power Supply $U_{AUX}$	—		20 to 30V DC PELV (protective very-low voltage; protection class 3 VDE0106 / IEC 60364-4-41 compliant)
	Operating Temperature	-25 to +60°C (no freezing)		
	Storage Temperature	-25 to +85°C (no freezing)		
	Degree of Protection	IP20 (EN 60529)		
	Connection Method	Detachable terminal block: Applicable wire size $\leq 2.5$ mm <sup>2</sup>		
	Weight	150 g		
Input	Mounting Method	DIN rail mounting		
	Input Points/Signals	4 DC inputs, 2- and 3-wire sensors (NPN)	4 DC inputs, 2- and 3-wire sensors (PNP)	
	Input Power	Supplied from AS-Interface line (default: internal switch set to INT) Supplied from an external 12 to 24V DC PELV (internal switch set to EXT)		
	Load Current Capacity	$\leq 150$ mA (provided with overload and short-circuit protection)		
	OFF Current	OFF $\leq 2$ mA		
Output	ON Current (sink)	ON $\geq 4$ mA		
	Output Points/Signals	—		3 PNP transistor outputs (with overload/short-circuit protection)
	Output Power	—		Supplied from external auxiliary power supply $U_{AUX}$
	Voltage	—		External auxiliary power voltage $U_{AUX} - 0.5V$
	Current	—		3A max. (OUT1), 1.5A max. (OUT2, OUT3), 6A total ( $T_B \leq 40^\circ C$ ) 2A max. (OUT1), 1A max. (OUT2, OUT3), 4A total ( $T_B \leq 60^\circ C$ )
Communication Error	—		Output turns off	
Communication	Slave Type	A/B slaves		
	Profile	IO	0	7
		ID	A	A
		ID2	0	0
Data Bits	Input	Output	Input	Output
D0	IN1	—	IN1	OUT1
D1	IN2	—	IN2	OUT2
D2	IN3	—	IN3	OUT3
D3	IN4	—	IN4	—
LED Indicators	PWR	AS-Interface power: Green LED		
	AUX	—		External auxiliary power $U_{AUX}$ : Green LED
	IN	4 yellow LEDs		
	OUT	—		
	FAULT	Error indication: Red LED ON: Communication error or address 0 Flash: Sensor power supply or output is overloaded		
	INT	Input power supplied from AS-Interface line: Green LED		
Address Assignment	Addressing Method	Connect the hand-held programming device (SX9Z-ADR1N) to the addressing port on the I/O module using the programming device cable (SX9Z-CN1), then the I/O module stops communication through the AS-Interface line. Change slave address using the programming device.		
Certification	AS-International Association			
Standards	UL/c-UL, CE			

# SX5A AS-Interface (Communication Terminal and Repeater)

## Internal Circuits

### • SX5A-SWN40S02

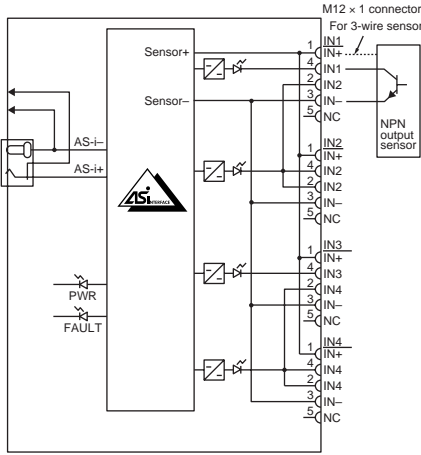

### • SX5A-SWN40K02N

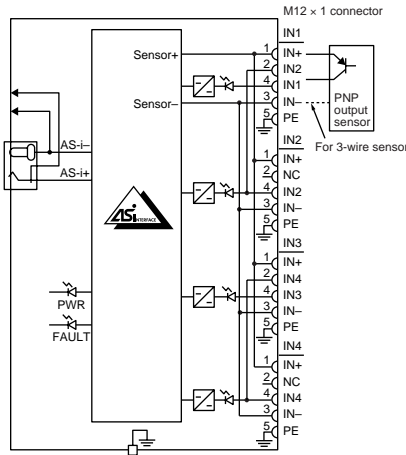

Connect to protective ground on control panel.

### • SX5A-SWM22KS2N

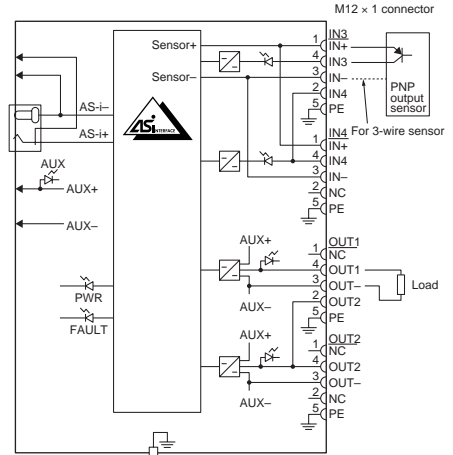

Connect to protective ground on control panel.

### • SX5A-SWM43KS2N

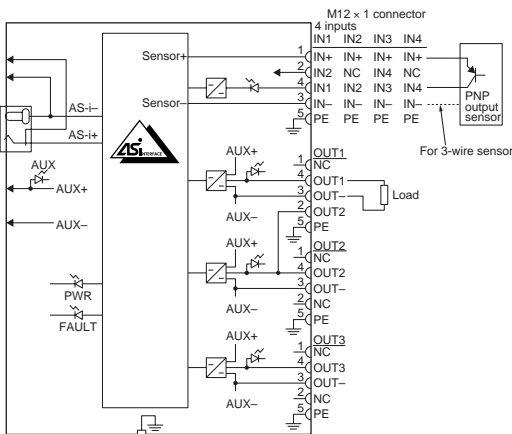

Connect to protective ground on control panel.

### • SX5A-SSN40S0N

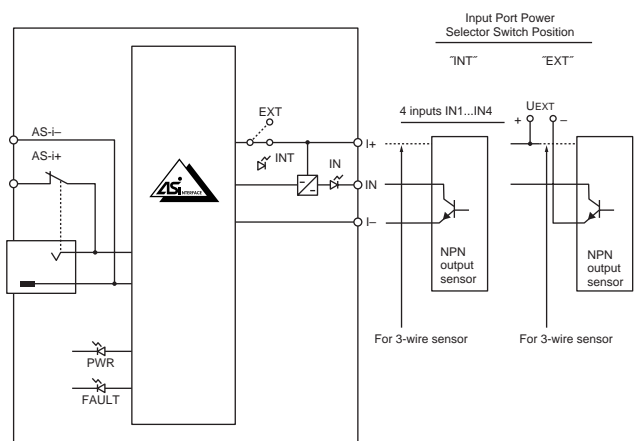

### • SX5A-SSN40K0N

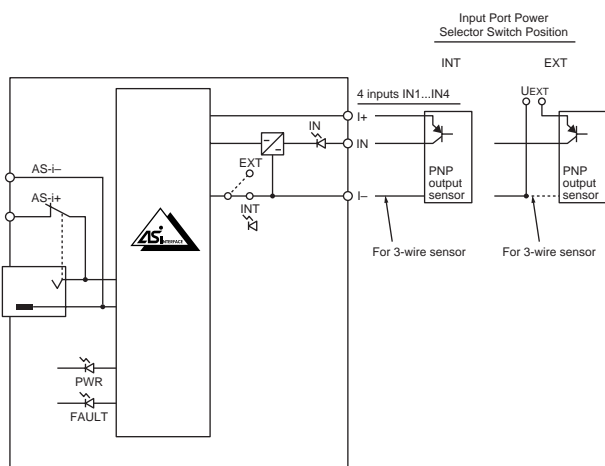

### • SX5A-SSM43KSN

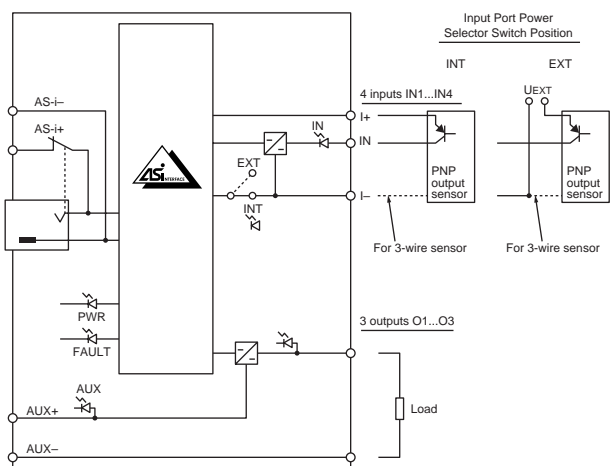



# SX5A AS-Interface (Communication Terminal and Repeater)

## Connector Arrangement

- SX5A-SWN40S02
- SX5A-SWN40K02N

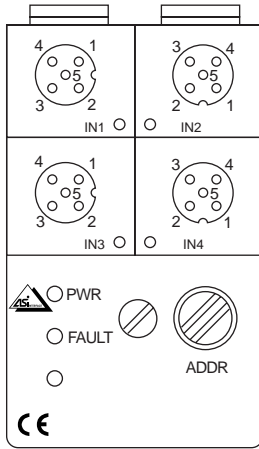

- SX5A-SWM22KS2N

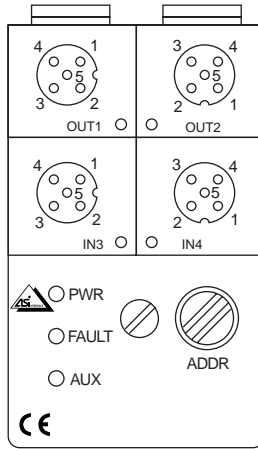

- SX5A-SWM43KS2N

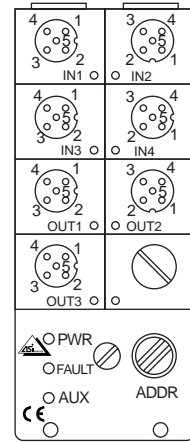

## Terminal Arrangement

- SX5A-SSN40S0N, SX5A-SSN40K0N

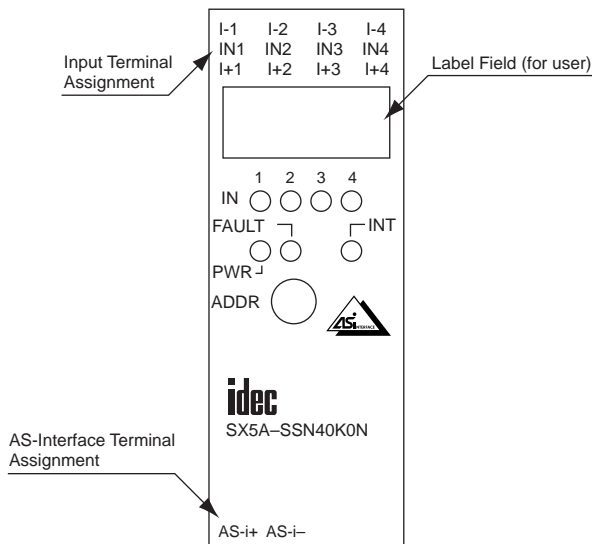

- SX5A-SSM43KSN

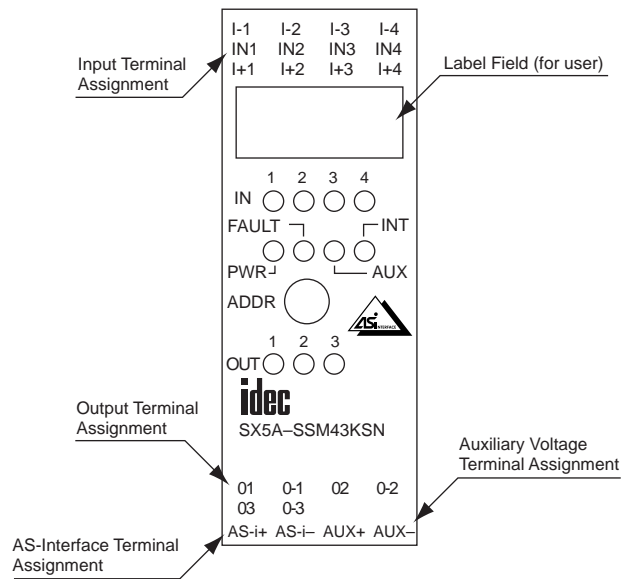

## Input Port Power Selection

Power for input ports and connected sensors can be supplied from either inside (AS-Interface) or outside (external power supply). The selection is done using the switch inside the I/O module.

While the input power is supplied from inside, the INT LED remains on. While the input power is supplied from outside, the INT LED remains off. I/O statuses are indicated on the front LED indicators.

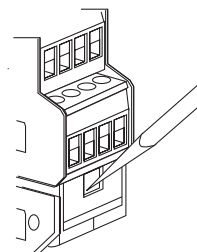

1. Unlock  
Press on BOTH sides.
2. Open  
Pull upper part until STOP.

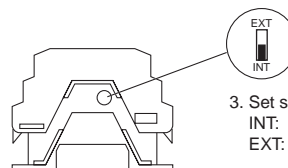

3. Set switch  
INT: sensor supply from AS-Interface  
EXT: external sensor supply

Switching the input power supply INT/EXT

# SX5A AS-Interface (Communication Terminal and Repeater)

## Dimensions

- SX5A-SWN40S02
- SX5A-SWN40K02N
- SX5A-SWM22KS2N

Base module is separately ordered.

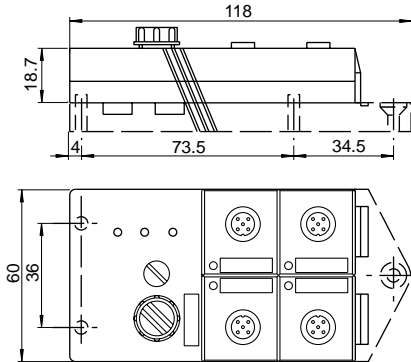

- SX5A-SWM43KS2N

Base module is separately ordered.

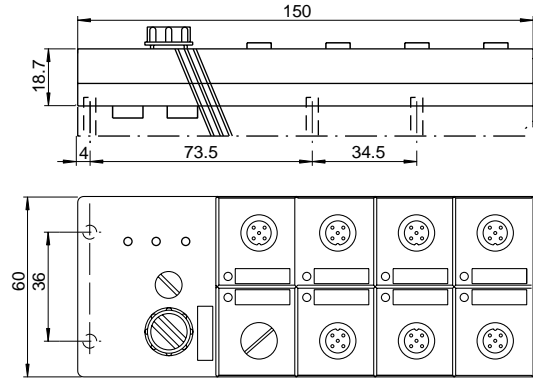

- SX5A-B3FF

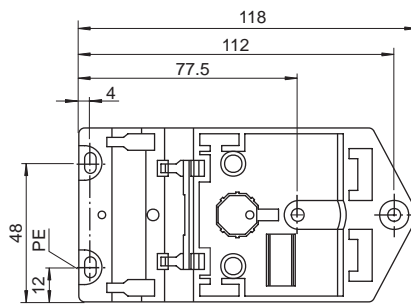

- SX5A-B2FF

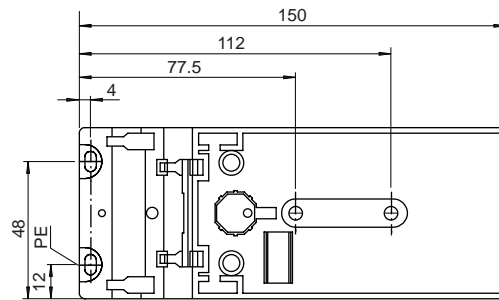

- SX5A-SSN40S0N
- SX5A-SSN40K0N
- SX5A-SSM43KSN

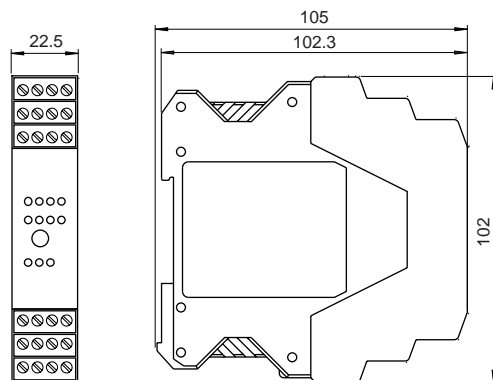

All dimensions in mm.

# SX5A AS-Interface (Communication Terminal and Repeater)

## Repeater

### SX5A-RP1

- No address setting required
- An AS-Interface network can be extended up to 300 m.
- IP65 protection
- The insulation penetration technology allows easy connection to AS-Interface flat cables.
- Input statuses of AS-Interface 1 and 2 are displayed with the LED indicators.
- The SX5A-RP1 repeater is used to extend the AS-Interface cable. One repeater extends the length of network for up to 100 m. A maximum of two repeaters can be used in a network, enabling the construction of a network of up to 300 m.
- The repeater does not require address setting.



## Specifications

Type No.	SX5A-RP1	
General	Rated Input Voltage	26.5 to 31.6V DC
	Rated Current	60 mA (per segment), 120 mA (total)
	Operating Temperature	0 to +55°C (no freezing)
	Storage Temperature	-25 to +75°C (no freezing)
	Operating Humidity	30 to 95% RH (no condensation)
	Degree of Protection	IP65
	Insulation Resistance	5 MΩ minimum (500V DC megger)
	Dielectric Strength	1000V AC, 1 minute
	Applicable Wire	AS-Interface flat cable
	Weight	Approx. 170 g
	Dimensions	60W × 118.5H × 22.5D mm
	Mounting	Screw mounting
Standard	CE	

### • LED Indicators (see Dimensions)

Indicators	Color (when ON)	Description
AS-Interface 1	Green	Power is supplied to line 1.
AS-Interface 2	Green	Power is supplied to line 2.

## Dimensions

### • SX5A-RP1

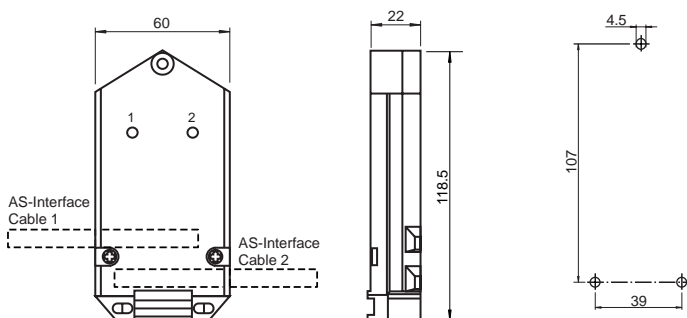

All dimensions in mm.

## Mounting Hole Layout

## System Setup

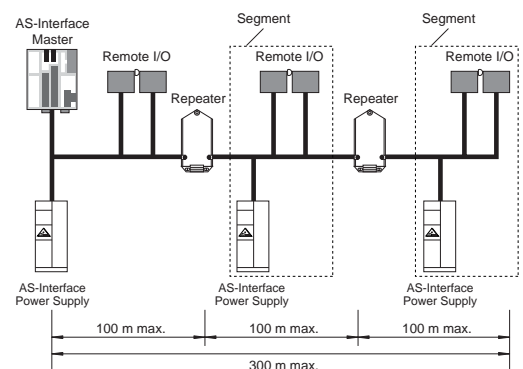

# SX5A AS-Interface (Communication Terminal and Repeater)

## • Hand-held Programming Device

Type No.	SX9Z-ADR1N
Standards	CE
Power Supply	Powered by built-in battery (recharged using the attached AC adapter)
Operation Time	8 hours or 250 read/write operations after full charge
Charging Time	Approx. 14 hours
Operating Temperature	0 to +55°C
Storage Temperature	-25 to +85°C (no freezing)
Degree of Protection	IP20
Weight	Approx. 275g
Communication Specifications	AS-Interface Version 2.1
Operation	Slave address assignment and data read/write (compatible with the 62-slave mode)
Connection	Connects to a slave using the attached programming device cable

## • Address Assignment for Communication Terminals

Remove the protection cap from the addressing port on the I/O module.

Connect the hand-held programming device (SX9Z-ADR1N) to the addressing port on the I/O module using the programming device cable (SX9Z-CN1), then the I/O module stops communication through the AS-Interface line. Change slave addresses using the programming device.

For addressing procedures, see the user's manual for the hand-held programming device.

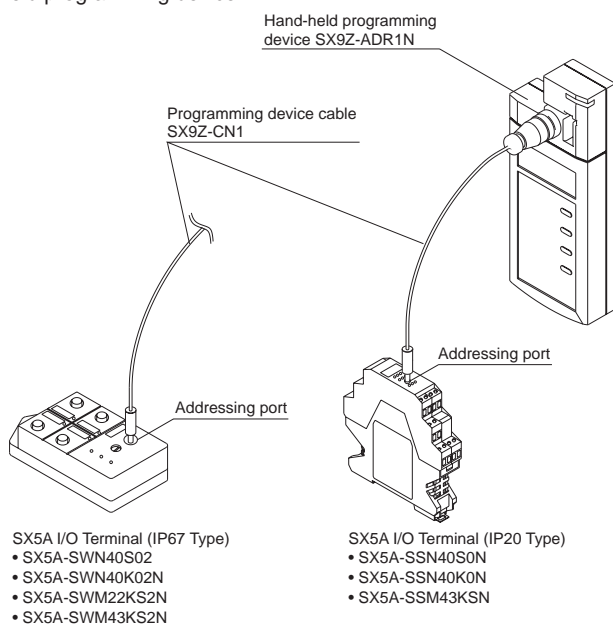

## • Using SwitchNet Addressing Port Adapter on HW

To open the addressing port lid, insert a screwdriver into the side slot as shown. Do not lose the lid since it falls apart the communication block.

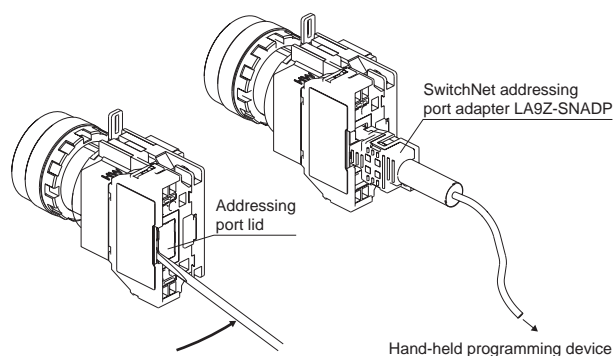

Attach the addressing port adapter to the programming device cable, and insert the addressing port adapter into the addressing port on the communication block.

## • Address Assignment for SwitchNet

Turn off the power to the SwitchNet control unit, and open the lid of the addressing port. Connect the programming device cable (SX9Z-CN1) to the hand-held programming device (SX9Z-ADR1N), and attach the SwitchNet addressing port adapter (LA9Z-SNADP) to the programming device cable (SX9Z-CN1). Insert the addressing port adapter into the addressing port on the SwitchNet control unit. Change slave address using the programming device.

For addressing procedures, see the user's manual for the hand-held programming device. After completing address assignment, attach the lid to the addressing port.

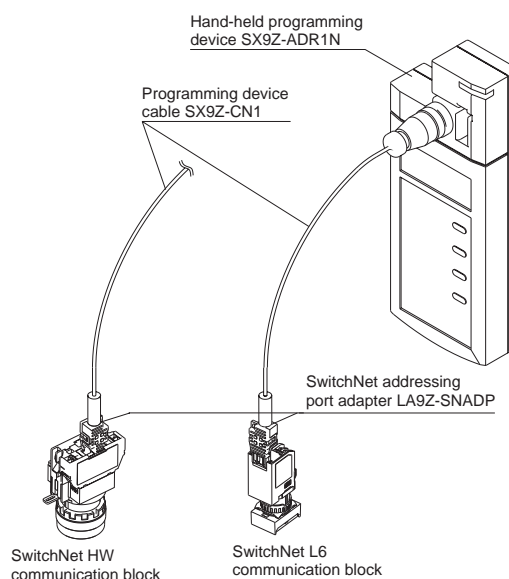

## • Using SwitchNet Addressing Port Adapter on L6

To open the addressing port lid, insert a screwdriver into the right-side hole as shown. The addressing port lid can be removed from the communication block by pulling it out strongly.

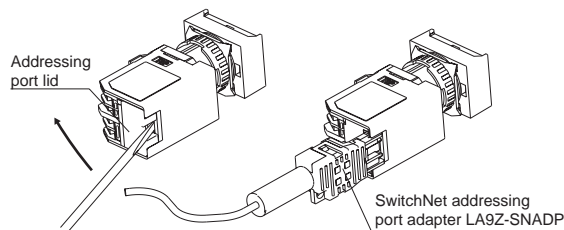

Attach the addressing port adapter to the programming device cable, and insert the addressing port adapter into the addressing port on the communication block.

# SwitchNet™ HW Series Control Units

## 216 Models of ø22dia Control Units Contain AS-Interface (ASI-SW)

- AS-Interface Ver. 2.1 compliant, capable of connecting 62 slaves
- Signals and power are carried through two wires.
- The wire length can be extended to 300m by using two repeaters.
- Spring clamp terminals save wiring time greatly.
- Available models include pushbuttons, pilot lights, illuminated pushbuttons, selector switches, key selector switches, and illuminated selector switches.
- Illuminated units can change the brightness in four levels: 100%, 50%, 25%, and 12.5%.
- The operator shapes and mounting hole dimensions are identical with the conventional HW series control units.
- Degree of protection: IP65 (from front of the panel)
- IEC 62026-2 compliant

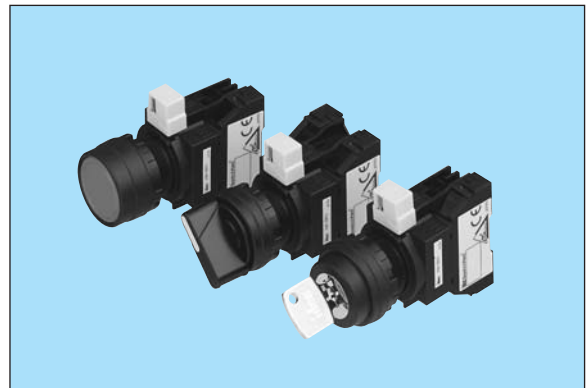

## Types







### • HW Series







Non-illuminated Pushbuttons	Style	Operation	Type No.	Button Color Code	Package Quantity	Note
	Round Flush	Momentary	HW1B-M1A110S①	B (black) G (green) R (red) S (blue) W (white) Y (yellow)  In place of ①, specify a button color code.	1	For dimensions, see page 35.
		Maintained	HW1B-A1A110S①			
	Round Extended	Momentary	HW1B-M2A110S①			
		Maintained	HW1B-A2A110S①			
	Mushroom ø29mm	Momentary	HW1B-M3A110S①			
		Maintained	HW1B-A3A110S①			
	Mushroom ø40mm	Momentary	HW1B-M4A110S①			
		Maintained	HW1B-A4A110S①			
	Square Flush	Momentary	HW2B-M1A110S①			
		Maintained	HW2B-A1A110S①			
	Square Extended	Momentary	HW2B-M2A110S①			
		Maintained	HW2B-A2A110S①			







Pilot Lights	Style	Type No.	Lens Color Code	Package Quantity	Note
	Round Flush	HW1P-1A101S4②-T	A (amber) G (green) R (red) S (blue) W (white) Y (yellow)	1	One LED lamp is included: LSTD-2②. For dimensions, see page 35.
	Square Flush	HW2P-1A101S4②-T	In place of ②, specify a lens color code.		

# SwitchNet™ HW Series Control Units

## • HW Series

Illuminated Pushbuttons	Style	Operation	Type No.	Lens Color Code	Package Quantity	Note
	Round Flush	Momentary	HW1L-M1A111S4②	A (amber) G (green) R (red) S (blue) W (white) Y (yellow) In place of ②, specify a lens color code.	1	One LED lamp is included: LSTD-2②. For dimensions, see page 35.
		Maintained	HW1L-A1A111S4②			
	Round Extended	Momentary	HW1L-M2A111S4②			
		Maintained	HW1L-A2A111S4②			
	Round Extended with Full Shroud	Momentary	HW1L-MF2A111S4②			
		Maintained	HW1L-AF2A111S4②			
	Mushroom ø29mm	Momentary	HW1L-M3A111S4②			
		Maintained	HW1L-A3A111S4②			
	Mushroom ø40mm	Momentary	HW1L-M4A111S4②			
		Maintained	HW1L-A4A111S4②			
	Square Flush	Momentary	HW2L-M1A111S4②			
		Maintained	HW2L-A1A111S4②			

Selector Switches	Style	Operation	Type No.	Package Quantity	Note	
	Knob	90° 2-position	Maintained 	HW1S-2A110S	1	For dimensions, see page 35. 3-position selector switches use two communication blocks.
			Spring Return from Right 	HW1S-21A110S		
		45° 3-position	Maintained 	HW1S-3A220XS		
			Spring Return from Right 	HW1S-31A220XS		
			Spring Return from Left 	HW1S-32A220XS		
			Spring Return Two-way 	HW1S-33A220XS		











Key Selector Switches	Style	Operation	Type No.	Key Retained Position Code	Package Quantity	
	Key	90° 2-position	Maintained 	HW1K-2③A110S	A, B, C	1
			Spring Return from Right 	HW1K-21③A110S	B	
		45° 3-position	Maintained 	HW1K-3③A220XS	A, B, C, D, E, G, H	
			Spring Return from Right 	HW1K-31③A220XS	B, D, G	
			Spring Return from Left 	HW1K-32③A220XS	C, D, H	
			Spring Return Two-way 	HW1K-33③A220XS	D	







Note 1: In place of ③ in the Type No., specify a key retained position code from the table below.

Note 2: 3-position selector switches use two communication blocks.

Note 3: For dimensions, see page 35.

### [Key Retained Position Code]

90° 2-position			45° 3-position						
A	B	C	A	B	C	D	E	G	H
									
No retained	Right retained	Left retained	No retained	Right retained	Left retained	R/L retained	Center retained	C/R retained	C/L retained

Illuminated Selector Switches	Style	Operation	Type No.	Lens Color Code	Package Quantity	
	Knob	90° 2-position	Maintained 	HW1F-2A111S4②	A (amber) G (green) R (red) S (blue) W (white) Y (yellow)	1
			Spring Return from Right 	HW1F-21A111S4②		
		45° 3-position	Maintained 	HW1F-3A221XS4②		
			Spring Return from Right 	HW1F-31A221XS4②		
			Spring Return from Left 	HW1F-32A221XS4②		
			Spring Return Two-way 	HW1F-33A221XS4②		

Note 1: In place of ② in the Type No., specify a lens color code.

















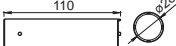

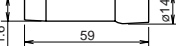

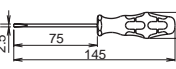

Note 2: 3-position selector switches use two communication blocks.

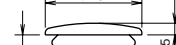
Note 3: One LED lamp is included: LSTD-2②.

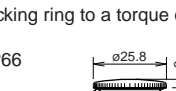
Note 4: For dimensions, see page 35.

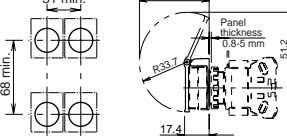
# SwitchNet™ HW Series Control Units

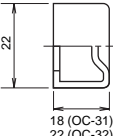

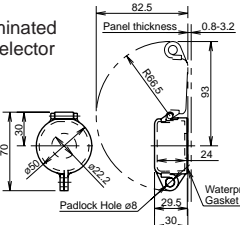



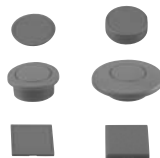

## • Accessories

Name & Appearance		Application/ Specification	Type No.	Ordering Type No.	Package Quantity	Remarks
		Branches AS-Interface flat cable to 2-wire cable	LA9Z-SNTB	LA9Z-SNTB	1	Current capacity 3A For wiring instructions, see page 35.
		Assigns slave addresses and monitor system configuration	SX9Z-ADR1N	SX9Z-ADR1N	1	Attachments: • Programming device cable (SX9Z-CN1) • Programming device AC adapter (SX9Z-ADPT) • SwitchNet addressing port adapter (LA9Z-SNADP) • Operating manual (English/Japanese)
		Connects the programming device to slave	SX9Z-CN1	SX9Z-CN1	1	Included with hand-held programming device SX9Z-ADR1N
		Charges the programming device	SX9Z-ADPT	SX9Z-ADPT	1	AC input voltage: 100-240V AC Included with hand-held programming device SX9Z-ADR1N
		Connects the programming device cable to SwitchNet	LA9Z-SNADP	LA9Z-SNADP	1	Included with hand-held programming device SX9Z-ADR1N
Tools		Made of metal Weight: Approx. 150g	MW9Z-T1	MW9Z-T1	1	Used to tighten the plastic locking ring. 
		Made of rubber	OR-55	OR-55	1	Used to remove and install LED lamps. 
		Weight: Approx. 20g	BC1S-SD0	BC1S-SD0	1	Used to wire spring clamp terminals. 
		Made of plastic	HW9Z-RL	HW9Z-RLPN10	10	Prevents rotation of control unit in mounting hole. 
		Black rubber	OB-31	OB-31PN05	5	For plugging unused $\varnothing 22$ mounting holes in panel. 
		Diecast metal (Locking ring: plastic)	LW9Z-BM	LW9Z-BM	1	<ul style="list-style-type: none"> <li>For plugging unused <math>\varnothing 22</math> mounting holes in panel.</li> <li>Tighten the attached locking ring to a torque of 1.2 N-m.</li> <li>Degree of protection: IP66</li> </ul> 
	Spring return	Made of plastic	HW9Z-K1	HW9Z-K1	1	<ul style="list-style-type: none"> <li>For preventing inadvertent operation on flush pushbuttons and illuminated pushbuttons.</li> <li>Degree of protection: IP65</li> <li>Maintained cover stops at 90° and 180°.</li> </ul> 
	Maintained cover		HW9Z-K11	HW9Z-K11	1	
	For flush buttons	Made of rubber (EPDM)	OC-31	OC-31	1	Used to cover and protect pushbuttons. Not used outdoors and not oil resistant. 
	For extended buttons		OC-32	OC-32	1	
		Body: Polyarylate Gasket: Nitrile rubber	HW9Z-KL1	HW9Z-KL1	1	Used to protect pushbuttons, illuminated pushbuttons, or selector switches. 

Note: When ordering, specify the Ordering Type No. and quantity.

# SwitchNet™ HW Series Control Units

## • HW Series Replacement Parts

Name & Appearance		Application/Specification	Type No.	Ordering Type No.	Package Quantity	Remarks
	Round Flush	Polyacetal	HW1A-B1①	HW1A-B1①PN05	5	In place of ①, specify a button color code. B (black) G (green) R (red) S (blue) W (white) Y (yellow)
	Round Extended	Polyacetal	HW1A-B2①	HW1A-B2①PN05	5	
	ø29 Mushroom	Polyacetal	HW1A-B3①	HW1A-B3①PN02	2	
	ø40 Mushroom	Polyacetal	HW1A-B4①	HW1A-B4①PN02	2	
	Square Flush	Polyacetal	HW2A-B1①	HW2A-B1①PN05	5	
	Square Extended	Polyacetal	HW2A-B2①	HW2A-B2①PN05	5	
	Round Flush Illuminated PB	Polyarylate	HW9Z-L11②	HW9Z-L11②PN05	5	In place of ②, specify a lens color code. A (amber) C (clear) G (green) R (red) S (blue) Y (yellow)  Note: For white illumination W, use a C (clear) lens.
	Round Extended Pilot Light Illuminated PB	Polyarylate	HW9Z-L12②	HW9Z-L12②PN05	5	
	Square Flush Pilot Light Illuminated PB	Polyarylate	HW9Z-L21②	HW9Z-L21②PN05	5	
	ø29 Illuminated PB	AS resin	ALW31L-②	ALW31L-②PN02	2	②: C (clear), G (green), R (red), S (blue)
		Marking type	ALW31LD-②	ALW31LD-②PN02	2	
	ø40 Illuminated PB	AS resin	ALW41L-②	ALW41L-②	1	②: C (clear), G (green), R (red), S (blue)
		Marking type	ALW41LD-②	ALW41LD-②	1	
	Round Flush	Acrylic resin	HW9Z-P11	HW9Z-P11PN05	5	Color: white
	Round Extended	Acrylic resin	HW9Z-P12	HW9Z-P12PN05	5	
	Square Flush	Acrylic resin	HW9Z-P21	HW9Z-P21PN05	5	
	ø29/ø40 Mushroom	Acrylic resin	ALW3B	ALW3BPN05	5	
		Polyarylate	HW9Z-FDY②	HW9Z-FDY②	1	In place of ②, specify a lens color code. A (amber) G (green) R (red) S (blue) W (white) Y (yellow)
	For key selector switch	Metallic	HW9Z-SK-231	HW9Z-SK-231PN02	2	
		Plastic	HW9Z-LN	HW9Z-LNPN05	5	Black
		Plastic	HW9Z-LS	HW9Z-LSPN10	10	Yellow

Note: When ordering, specify the Ordering Type No. and quantity.

## • LED Lamp

Rated Voltage	Current Draw	Type No.	Ordering Type No.	Lens Color Code	Package Quantity	Lamp Base
24V AC/DC ±10%	10mA AC 11mA DC	LSTD-2②	LSTD-2②	A (amber), G (green), R (red), S (blue), W (white), Y (yellow) In place of ②, specify a lens color code.	1	BA9S
			LSTD-2②PN10		10	

Note: When ordering, specify the Ordering Type No.

## • HW Nameplates

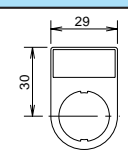
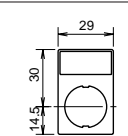
Name	Specifications	Type No.	Ordering Type No.	Package Quantity	Note/Dimensions
HWAM Nameplate	Without legend plate Made of black plastic 1.5 mm thick	HWAM	HWAM	1	Order a legend plate HWNP-④ separately. 
			HWAMPN10	10	
HWAQ Nameplate	Without legend plate Made of black plastic 1.5 mm thick	HWAQ	HWAQ	1	Order a legend plate HWNP-④ separately. 
			HWAQPN10	10	

Note: When ordering, specify the Ordering Type No.



# SwitchNet™ HW Series Control Units

## • Legend Plate

Name	Specifications	Type No.	Ordering Type No.	Package Quantity	Note/Dimensions
HWNP Legend Plate	Black aluminum plate 1.0 mm thick	HWNP-④	HWNP-④	1	White letter on black background. In place of ④, specify a legend code from the table below. 
			HWNP-④PN10	10	

When ordering, specify the Ordering Type No.

### [Legend Codes ④ for Legend Plate]

Legend Code ④	Legend
0	(blank)
1	ON
2	OFF
3	START
4	STOP
31	OFF-ON
35	HAND-AUTO
53	HAND-OFF-AUTO

- Fig. 1 shows the procedure to install the legend plate into the nameplate.
- Fig. 2 shows how to remove the legend plate from the nameplate. Insert a thin screwdriver into the top of the legend plate to remove the legend plate.
- When using the nameplate, the applicable panel thickness reduces by 1.5 mm, the thickness of the nameplate.
- When anti-rotation is not necessary and the recess is not provided in the mounting hole, break the anti-rotation tab off the nameplate as shown in Fig. 2.

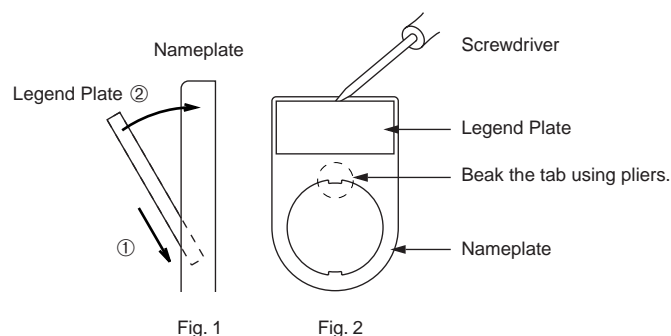

## Specifications

### • General Specifications

Operating Voltage	26.5 to 31.6V DC
Maximum Input Current	Pushbutton, selector 2-position, key selector 2-position: 16 mA Pilot light, illuminated PB, illuminated selector 2-position: 25 mA Selector 3-position, key selector 3-position: 32 mA (2 slaves: 1-in slave 16 mA) Illuminated selector 3-position: 41 mA (2 slaves: 1-in slave 16 mA, 1-in/1-out slave 25 mA)
Dielectric Strength	Between AS-Interface terminal and dead parts: 500V AC, 1 minute
Insulation Resistance	Between AS-Interface terminal and dead parts: 100 MΩ minimum (500V DC megger)
Operating Temperature	-25 to +55°C (no freezing)
Storage Temperature	-40 to +80°C (no freezing)
Operating Humidity	95% RH maximum (non-condensing)
Altitude	Operate: 2000m maximum, Transport: 3000m maximum
Pollution Degree	3 (IEC 60664)
Degree of Protection	IP65 (outside of panel)
Corrosion Immunity	Atmosphere free from corrosive gases
Vibration Resistance	5 to 55 Hz amplitude 0.5 mm, 50 m/s <sup>2</sup> (5G) 1 hour per axis on each of three mutually perpendicular axes
Shock Resistance	1000 m/s <sup>2</sup> (100G), 5 shocks on each of three mutually perpendicular axes
Weight	Approx. 40g (3-position selector switches: approx. 44g)

### • Communication Specifications

Applicable Standard	AS-Interface Ver. 2.1
Slave Profile	I/O code/ID code/ID2 code: B/A/E
Occupied Slave Addresses	Pushbutton, pilot light, illuminated PB, selector 2-position (knob, key, illuminated): 1 slave address Selector 3-position (knob, key, illuminated): 2 slave addresses
Digital I/O Data Allocation	See page 34.
Illumination Control	LED illumination brightness of SwitchNet units can be controlled using the Write_Parameter command. For Write_Parameter command and settings, see page 29.
AS-Interface Communication Specifications	Control system: Master/slave system Topology: Free topology Transmission medium: 2-wire cable Maximum slaves: 62 (A/B slaves), 31 (standard slaves) Maximum I/O points: 434 (A/B slaves), 248 (standard slaves) Maximum network length: 100m (without repeater) Maximum bus scan time: 10 ms (62 A/B slaves), 5 ms (31 standard slaves)

# SwitchNet™ HW Series Control Units

## • Mechanical/Electrical Specifications

Terminal Style	Spring clamp
Applicable Wire	Parallel 2-wire cable (twisted cable not applicable) Single wires can also be used for connection over short distances. Stranded wire: 0.5 to 0.75 mm <sup>2</sup> (AWG20 to 18) Solid wire: 0.5 to 1.5 mm <sup>2</sup> (AWG20 to 16) When using a ferrule on a stranded wire, use the ferrule shown far below on this page. Do not twist single wires together.
Mounting Hole Size	ø22.3 mm, +0.4 or -0 mm
Applicable LED Lamp	LSTD-2② (rated current 10 mA DC)
Mechanical Life	Momentary: 5,000,000 operations minimum Maintained, selector: 500,000 operations minimum Addressing port adapter durability: 100 insertions/removals minimum

## • Certification

Certification	AS-International Association
Standards	UL listed, c-UL listed, CE marked

## • Digital I/O Data Allocation

Slave Unit	Used I/O	Communication Block Mounting Position	Input Data (slave send data)				Output Data (slave receive data)			
			DI3	DI2	DI1	DI0	DO3	DO2	DO1	DO0
Pushbutton	1 in	②	0	X1	1	1	*	—	—	—
Pilot light	1 out	②	0	0	1	1	*	—	—	X1
Illuminated pushbutton	1 in/1 out	②	0	X1	1	1	*	—	—	X1
Selector, Key selector 2-position	1 in	②	0	X2	1	1	*	—	—	—
Selector, Key selector 3-position	1 in	①	0	X3	1	1	*	—	—	—
	1 in	②	0	X3	1	1	*	—	—	—
Illuminated selector 2-position	1 in/1 out	②	0	X2	1	1	*	—	—	X1
Illuminated selector 3-position	1 in	①	0	X3	1	1	*	—	—	—
	1 in/1 out	②	0	X3	1	1	*	—	—	X1

Notes:

- In the above table, bits marked with X1, X2, and X3 are used.
- X1: When pushbutton is pressed, input data is 1 (on). When not pressed, input data is 0 (off). When output data is 1 (on), LED is on. When output data is 0 (off), LED is off.
- X2: The input data of 2-position selector switches depend on the operator position as shown below.

2-position Operator		
Operator Position	1	2
DI2	0	1

- X3: The input data of 3-position selector switches depend on the operator position as shown below.

3-position Operator				
Operator Position	1	0	2	
Communication Block Mounting Position	Input Data Bit			
①	DI2	1	0	0
②	DI2	0	0	1

- Unused input bits DI3 and DI2 are 0 (off), and unused input bits DI1 and DI0 are 1 (on). Slaves ignore unused output data sent from the master.
- \*: The master uses bit DO3 for addressing A/B slaves.

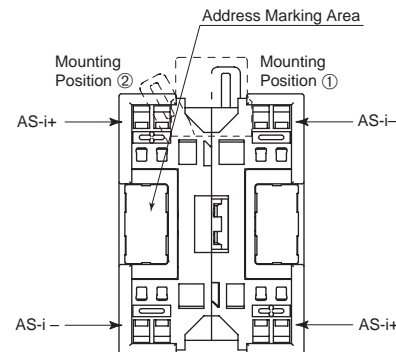

On 3-position selector switches and illuminated selector switches, communication blocks ① and ② are mounted in positions as shown above.

## • Write\_Parameter Command

0	0	A4	A3	A2	A1	A0	1	Sel P3	P2	P1	P0	PB	1
---	---	----	----	----	----	----	---	--------	----	----	----	----	---

## [Write\_Parameter Settings]

LED Brightness	Settings			Remarks
	Output Selection	Control Data		
		P2	P1	
100%	1: DO0 0: DO1	1	1	Default
50%		0	1	
25%		1	0	
12.5%		0	0	

## • Ferrules (Phoenix Contact)

Cable Size (Stranded)	Phoenix Type	Order No.	Pcs./Pkt.
0.5 mm <sup>2</sup> (AWG20)	AI 0,5-8 WH	32 00 01 4	100
0.75 mm <sup>2</sup> (AWG18)	AI 0,75-8 GY	32 00 51 9	100

# SwitchNet™ HW Series Control Units

## Dimensions

All dimensions in mm.

### • Top and Side Views

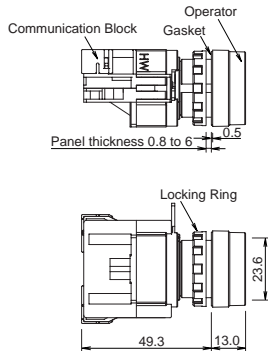

### • Pilot Lights • Illuminated Pushbuttons

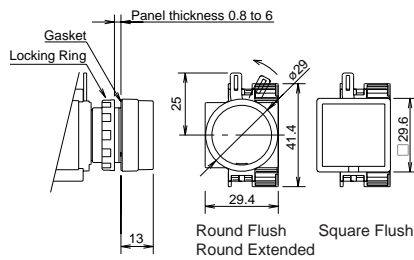

### • Selector Switch

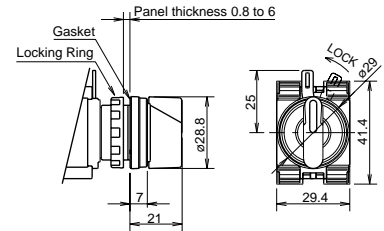

### • Pushbuttons

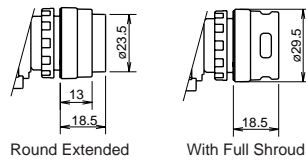
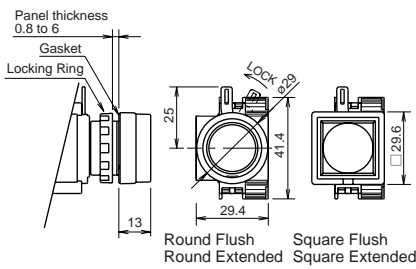

### • Key Selector Switch

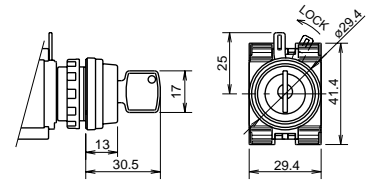

### • Illuminated Selector Switch

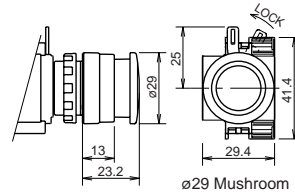
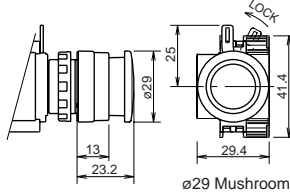
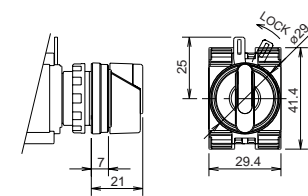

### Panel Cut-out

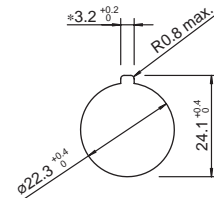

The 3.2 recess marked with \* is for anti-rotation. When nameplates and anti-rotation rings are not used, this recess is not necessary.

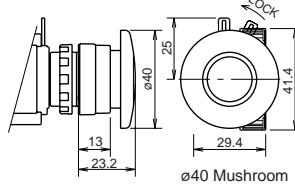
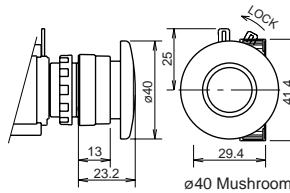

## T-branch Connector: LZ9Z-SNTB

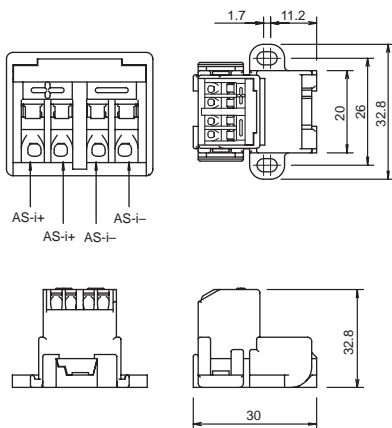

### Mounting Hole Layout

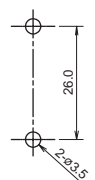

### • Wiring Instructions

1. Locate the wire hole on top of the T-branch connector. To open the spring clamp in the wire hole, insert an optional screwdriver (BC1S-SD0) diagonally into the adjoining screwdriver hole until it hits the bottom. Slightly jerk the screwdriver to insert easily.

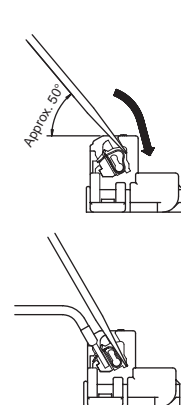

### Screwdriver Tip According to DIN5264

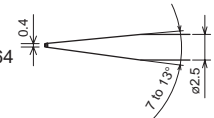

2. With the screwdriver held in the hole, insert a wire or ferrule to the bottom of the wire hole, then pull out the screwdriver.

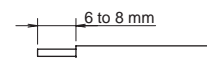

3. Strip the cable insulation 6 to 8 mm from the end. When wiring with 0.75 mm<sup>2</sup> or AWG18 stranded wires, use of the ferrule shown on page 34 is recommended to ensure a sufficient tensile strength. If a stranded wire of this thickness is connected without using a ferrule, the wire tensile strength reduces.

# SwitchNet™ L6 Series Control Units

## 277 Models of ø16dia Control Units Contain AS-Interface (ASI-SW)

- AS-Interface Ver. 2.1 compliant, capable of connecting 62 slaves
- Signals and power are carried through two wires.
- The wire length can be extended to 300m by using two repeaters.
- Spring clamp terminals save wiring time greatly.
- Available models include pushbuttons, pilot lights, illuminated push-buttons, selector switches, key selector switches, illuminated selector switches, and lever switches.
- Illuminated units can change the brightness in four levels: 100%, 50%, 25%, and 12.5%.
- The operator shapes and mounting hole dimensions are identical with the conventional L6 series control units.
- Degree of protection: IP65 (from front of the panel)
- IEC 62026-2 compliant

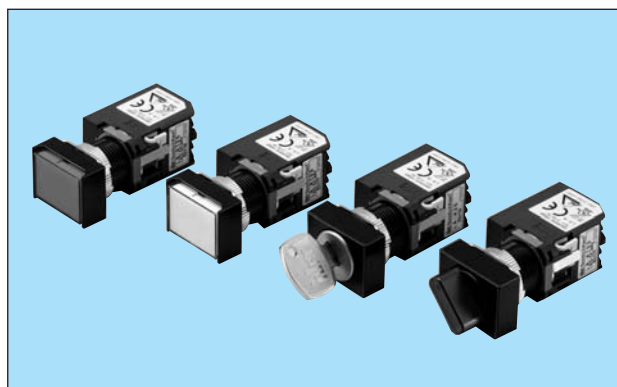

## Types





















### • L6 Series





















Non-illuminated Pushbuttons	Style	Operation	Type No.	Button Color Code	Package Quantity	Note
	Round	Momentary	LA1B-M1A1S①	B (black) G (green) R (red) S (blue) W (white) Y (yellow)  In place of ①, specify a button color code.	1	For dimensions, see page 42.
		Maintained	LA1B-A1A1S①			
	Square	Momentary	LA2B-M1A1S①			
		Maintained	LA2B-A1A1S①			
	Rectangular	Momentary	LA3B-M1A1S①			
		Maintained	LA3B-A1A1S①			

Pilot Lights	Style	Type No.	Button Color Code	Package Quantity	Note
	Round	LA1P-1A04S②	A (amber) G (green) R (red) S (blue) W (white) Y (yellow)  In place of ②, specify a lens color code.	1	One LED lamp is included: LFTD-2②. For dimensions, see page 42.
	Square	LA2P-1A04S②			
	Rectangular	LA3P-1A04S②			

Illuminated Pushbuttons	Style	Operation	Type No.	Button Color Code	Package Quantity	Note
	Round	Momentary	LA1L-M1A14S②	A (amber) G (green) R (red) S (blue) W (white) Y (yellow)  In place of ②, specify a lens color code.	1	One LED lamp is included: LFTD-2②. For dimensions, see page 42.
		Maintained	LA1L-A1A14S②			
	Square	Momentary	LA2L-M1A14S②			
		Maintained	LA2L-A1A14S②			
	Rectangular	Momentary	LA3L-M1A14S②			
		Maintained	LA3L-A1A14S②			

# SwitchNet™ L6 Series Control Units









Selector Switches	Style	Operation			Type No.	Package Quantity	Note
	Round	90° 2-position	Maintained		LA1S-2A1S	1	For dimensions, see page 42.
			Spring Return from Right		LA1S-21A1S		
		45° 3-position	Maintained		LA1S-3A2S		
			Spring Return from Right		LA1S-31A2S		
			Spring Return from Left		LA1S-32A2S		
Spring Return Two-way		LA1S-33A2S					
	Square	90° 2-position	Maintained		LA2S-2A1S		
			Spring Return from Right		LA2S-21A1S		
		45° 3-position	Maintained		LA2S-3A2S		
			Spring Return from Right		LA2S-31A2S		
			Spring Return from Left		LA2S-32A2S		
Spring Return Two-way		LA2S-33A2S					
	Rectangular	90° 2-position	Maintained		LA3S-2A1S		
			Spring Return from Right		LA3S-21A1S		
		45° 3-position	Maintained		LA3S-3A2S		
			Spring Return from Right		LA3S-31A2S		
			Spring Return from Left		LA3S-32A2S		
Spring Return Two-way		LA3S-33A2S					

Key Selector Switches	Style	Operation			Type No.	Key Retained Position Code ③	Package Quantity
	Round	90° 2-position	Maintained		LA1K-2A1S③	A, B, C	1
			Spring Return from Right		LA1K-21A1S③	B	
		45° 3-position	Maintained		LA1K-3A2S③	A, B, C, D, E, G, H	
			Spring Return from Right		LA1K-31A2S③	B, D, G	
			Spring Return from Left		LA1K-32A2S③	C, D, H	
Spring Return Two-way		LA1K-33A2S③	D				
	Square	90° 2-position	Maintained		LA2K-2A1S③	A, B, C	
			Spring Return from Right		LA2K-21A1S③	B	
		45° 3-position	Maintained		LA2K-3A2S③	A, B, C, D, E, G, H	
			Spring Return from Right		LA2K-31A2S③	B, D, G	
			Spring Return from Left		LA2K-32A2S③	C, D, H	
Spring Return Two-way		LA2K-33A2S③	D				
	Rectangular	90° 2-position	Maintained		LA3K-2A1S③	A, B, C	
			Spring Return from Right		LA3K-21A1S③	B	
		45° 3-position	Maintained		LA3K-3A2S③	A, B, C, D, E, G, H	
			Spring Return from Right		LA3K-31A2S③	B, D, G	
			Spring Return from Left		LA3K-32A2S③	C, D, H	
Spring Return Two-way		LA3K-33A2S③	D				



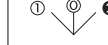

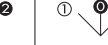
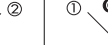















Note 1: In place of ③ in the Type No., specify a key retained position code from the table below.

Note 2: For dimensions, see page 42.

## [Key Retained Position Code]









90° 2-position			45° 3-position						
A	B	C	A	B	C	D	E	G	H
									
No retained	Right retained	Left retained	No retained	Right retained	Left retained	R/L retained	Center retained	C/R retained	C/L retained

# SwitchNet™ L6 Series Control Units

Illuminated Selector Switches	Style	Operation			Type No.	Lens Color Code	Package Quantity		
	Round	90° 2-position	Maintained		LA1F-2A14S②	A (amber) G (green) R (red) S (blue) W (white) Y (yellow) In place of ② in the Type No., specify a lens color code.	1		
			Spring Return from Right		LA1F-21A14S②				
		45° 3-position	Maintained		LA1F-3A24S②				
			Spring Return from Right		LA1F-31A24S②				
			Spring Return from Left		LA1F-32A24S②				
Spring Return Two-way		LA1F-33A24S②							
	Square	90° 2-position	Maintained		LA2F-2A14S②			A (amber) G (green) R (red) S (blue) W (white) Y (yellow) In place of ② in the Type No., specify a lens color code.	1
			Spring Return from Right		LA2F-21A14S②				
		45° 3-position	Maintained		LA2F-3A24S②				
			Spring Return from Right		LA2F-31A24S②				
			Spring Return from Left		LA2F-32A24S②				
		Spring Return Two-way		LA2F-33A24S②					
	Rectangular	90° 2-position	Maintained		LA3F-2A14S②	A (amber) G (green) R (red) S (blue) W (white) Y (yellow) In place of ② in the Type No., specify a lens color code.	1		
			Spring Return from Right		LA3F-21A14S②				
		45° 3-position	Maintained		LA3F-3A24S②				
			Spring Return from Right		LA3F-31A24S②				
			Spring Return from Left		LA3F-32A24S②				
		Spring Return Two-way		LA3F-33A24S②					









Note 1: One LED lamp is included: LFTD-2②.

Note 2: For dimensions, see page 42.

Lever Switches	Style	Operation			Type No.	Package Quantity	Note
	Round	2-position	Maintained		LA1T-2A1S	1	For dimensions, see page 42.
			Spring Return from Up		LA1T-21A1S		
			Spring Return from Down		LA1T-22A1S		
		3-position	Maintained		LA1T-3A2S		
			Spring Return from Up		LA1T-31A2S		
			Spring Return from Down		LA1T-32A2S		
			Spring Return Two-way		LA1T-33A2S		

# SwitchNet™ L6 Series Control Units

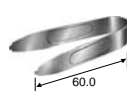
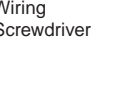
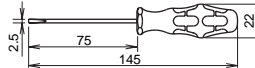
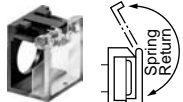

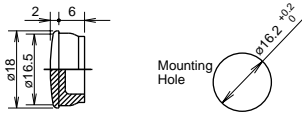
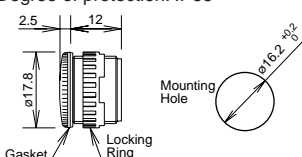

## • L6 Accessories

Name & Appearance		Application/ Specification	Type No.	Ordering Type No.	Package Quantity	Remarks
		Branches AS-Interface flat cable to 2-wire cable	LA9Z-SNTB	LA9Z-SNTB	1	Current capacity 3A For wiring instructions, see page 35.
		Assigns slave addresses and monitor system configuration	SX9Z-ADR1N	SX9Z-ADR1N	1	Attachments: • Programming device cable (SX9Z-CN1) • Programming device AC adapter (SX9Z-ADPT) • SwitchNet addressing port adapter (LA9Z-SNADP) • Operation manual (English/Japanese)
		Connects the programming device to slave	SX9Z-CN1	SX9Z-CN1	1	Included with hand-held programming device SX9Z-ADR1N
		Charges the programming device	SX9Z-ADPT	SX9Z-ADPT	1	AC input voltage: 100-240V AC Included with hand-held programming device SX9Z-ADR1N
		Connects the programming device cable to SwitchNet	LA9Z-SNADP	LA9Z-SNADP	1	Included with hand-held programming device SX9Z-ADR1N
Tools		Made of nickel-plated brass	MT-001	MT-001	1	• Used to tighten the plastic locking ring when installing the L6 unit on a panel. • Tightening torque: 0.88 N-m maximum
		Made of rubber	OR-44	OR-44	1	Used to remove and install LED lamps.
		Made of stainless steel	MT-101	MT-101	1	Used to remove the lens or button from the operator.
		Weight: Approx. 20g	BC1S-SD0	BC1S-SD0	1	Used to wire spring clamp terminals. 
	For round/square units	Material: Polyarylate (lens and base)	AL-K6SP	AL-K6SP	1	• For preventing inadvertent operation. • Degree of protection: IP65 • For dimensions, see page 43.
	For rectangular units		AL-KH6SP	AL-KH6SP	1	
	For round units	Clear part: Elastomer Black part: Polypropylene	AL-D6	AL-D6	1	• For minimum mounting centers when using dust proof covers, see page 43. • Operating temperature: -10 to +55°C
	For square units		AL-DQ6	AL-DQ6	1	
	For rectangular units		AL-DH6	AL-DH6	1	
	Rubber Mounting Hole Plug	Nitrile rubber (black)	AL-B6	AL-B6PN05	5	Degree of protection: IP65 
	Metallic Mounting Hole Plug	Metal (Locking ring: plastic)	AL-BM6	AL-BM6	1	Degree of protection: IP65 

Note: When ordering, specify the Ordering Type No. and quantity.

# SwitchNet™ L6 Series Control Units

## • L6 Series Replacement Parts

Name & Appearance	Material	Type No.	Ordering Type No.	Package Quantity	Remarks	
	For round units	Polyarylate	AL6M-B①	AL6M-B①PN05	5	In place of ①, specify a button color code. B (black), G (green), R (red), S (blue), W (white), Y (yellow)
	For square units	Polyarylate	AL6Q-B①	AL6Q-B①PN05		
	For rectangular units	Polyarylate	AB6H-B①	AB6H-B①PN05		
	For round units	Polyarylate	AL6M-L②	AL6M-L②PN05	5	In place of ②, specify a lens color code. A (amber), C (clear), G (green), R (red), S (blue), Y (yellow) Note: For white illumination W, use a C (clear) lens.
	For square units	Polyarylate	AL6Q-L②	AL6Q-L②PN05		
	For rectangular units	Polyarylate	AL6H-L②	AL6H-L②PN05		
	For round units	Acrylic resin	AL6M-W	AL6M-WPN05	5	White
	For square units	Acrylic resin	AL6Q-W	AL6Q-WPN05		
	For rectangular units	Acrylic resin	AL6H-W	AL6H-WPN05		
	For key selector switch	Nickel-plated brass	AS6-SK-132	AS6-SK-132PN02	2	Thickness: 2 mm
	For illuminated selector switch	Plastic	LA1A-F②	LA1A-F②PN02	2	In place of ②, specify a lens color code. A (amber), G (green), R (red), S (blue), W (white), Y (yellow)

Note: When ordering, specify the Ordering Type No. and quantity.

## • LED Lamp

Rated Voltage	Current Draw	Type No.	Ordering Type No.	Lens Color Code	Package Quantity	Lamp Base
24V AC/DC ±10%	8 mA AC/DC	LFTD-2②	LFTD-2②	A (amber), G (green), R (red), S (blue), W (white), Y (yellow) In place of ②, specify a lens color code.	1	T 1-3/4 Miniature flange base
			LFTD-2②PN10		10	

Note: When ordering, specify the Ordering Type No.

## Specifications

### • General Specifications

Operating Voltage	26.5 to 31.6V DC
Maximum Input Current	Pushbutton, selector, key selector, lever: 16 mA Pilot light, illuminated pushbutton, illuminated selector: 22 mA
Dielectric Strength	Between AS-Interface terminal and dead parts:500V AC, 1 minute
Insulation Resistance	Between AS-Interface terminal and dead parts:100 MΩ minimum (500V DC megger)
Operating Temperature	-25 to +55°C (no freezing)
Storage Temperature	-40 to +80°C (no freezing)
Operating Humidity	95% RH maximum (non-condensing)
Altitude	Operate: 2000m maximum Transport: 3000m maximum
Pollution Degree	3 (IEC 60664)
Degree of Protection	IP65 (outside of panel: operator), IP20 (inside of panel: terminal)
Corrosion Immunity	Atmosphere free from corrosive gases
Vibration Resistance	5 to 55 Hz amplitude 0.5 mm, 50 m/s <sup>2</sup> (5G) 1 hour per axis on each of three mutually perpendicular axes
Shock Resistance	1000 m/s <sup>2</sup> (100G), 5 shocks on each of three mutually perpendicular axes
Weight	Approx. 20g

### • Communication Specifications

Applicable Standard	AS-Interface Ver. 2.1
Slave Profile	I/O code/ID code/ID2 code: B/A/E
Occupied Slave Address	1 slave address
Digital I/O Data Allocation	See page 38.
Illumination Control	LED illumination brightness of SwitchNet units can be controlled using the Write_Parameter command. For Write_Parameter command and settings, see page 41.
AS-Interface Communication Specifications	Control system: Master/slave system Topology: Free topology Transmission medium: 2-wire cable Maximum slaves: 62 (A/B slaves), 31 (standard slaves) Maximum I/O points: 434 (A/B slaves), 248 (standard slaves) Maximum network length: 100m (without repeater) Maximum bus scan time: 10 ms (62 A/B slaves), 5 ms (31 standard slaves)



# SwitchNet™ L6 Series Control Units

## • Mechanical/Electrical Specifications

Terminal Style	Spring clamp
Applicable Wire	Parallel 2-wire cable (twisted cable not applicable) Single wires can also be used for connection over short distances. Stranded wire: 0.5 to 0.75 mm <sup>2</sup> (AWG20 to 18) Solid wire: 0.5 to 1.5 mm <sup>2</sup> (AWG20 to 16) When using a ferrule on a stranded wire, use the ferrule shown far below on this page. Do not twist single wires together.
Mounting Centers	Vertical: 18 mm, Horizontal: 24 mm
Mounting Hole Size	ø16.2 mm, +0.2 or -0 mm
Applicable LED Lamp	LFTD-2② (rated current 8 mA AC/DC)
Mechanical Life	Momentary: 2,000,000 operations minimum Maintained, selector, lever: 250,000 operations minimum Addressing port adapter durability: 100 insertions/removals minimum

## • Certification

Certification	AS-International Association
Standards	UL listed, c-UL listed, CE marked

## • Digital I/O Data Allocation

Slave Unit	Used I/O	Input Data (slave send data)				Output Data (slave receive data)			
		DI3	DI2	DI1	DI0	DO3	DO2	DO1	DO0
Pushbutton	1 in	0	X1	1	1	*	—	—	—
Pilot light	1 out	0	0	1	1	*	—	—	X1
Illuminated pushbutton	1 in/1 out	0	X1	1	1	*	—	—	X1
Selector, Key selector, Lever 2-position	1 in	0	X2	1	1	*	—	—	—
Selector, Key selector, Lever 3-position	2 in	X3	X3	1	1	*	—	—	—
Illuminated selector 2-position	1 in/1 out	0	X2	1	1	*	—	—	X1
Illuminated selector 3-position	2 in/1 out	X3	X3	1	1	*	—	—	X1

Notes:

- In the above table, bits marked with X1, X2, and X3 are used.
- X1: When pushbutton is pressed, input data is 1 (on). When not pressed, input data is 0 (off). When output data is 1 (on), LED is on. When output data is 0 (off), LED is off.
- X2: The input data of 2-position selector switches and 2-position lever switches depend on the operator position as shown below.

2-position Operator		
Operator Position	1	2
DI2	0	1

- X3: The input data of 3-position selector switches and 3-position lever switches depend on the operator position as shown below.

3-position Operator			
Operator Position	1	0	2
DI3	0	0	1
DI2	1	0	0

- Unused input bits DI3 and DI2 are 0 (off), and unused input bits DI1 and DI0 are 1 (on). Slaves ignore unused output data sent from the master.
- \*: The master uses bit DO3 for addressing A/B slaves.

## • Write\_Parameter Command

0	0	A4	A3	A2	A1	A0	1	Sel P3	P2	P1	P0	PB	1
---	---	----	----	----	----	----	---	-----------	----	----	----	----	---

## [Write\_Parameter Settings]

LED Brightness	Settings			Remarks
	Output Selection	Control Data		
	P2	P1	P0	
100%	1: DO0 0: DO1	1	1	Default
50%		0	1	
25%		1	0	
12.5%		0	0	

## • Ferrules (Phoenix Contact)

Cable Size (Stranded)	Phoenix Type	Order No.	Pcs./Pkt.
0.5 mm <sup>2</sup> (AWG20)	AI 0,5-8 WH	32 00 01 4	100
0.75 mm <sup>2</sup> (AWG18)	AI 0,75-8 GY	32 00 51 9	100

## • Marking Plate Size and Engraving Area for Illuminated Units

Style	Marking Plate Size	Marking Area
Round	ø13.8 mm	ø12 mm
Square	13.8 × 13.8 mm	12 × 12 mm
Rectangular	13.8 × 19.8 mm	12 × 18 mm

Note: Engraving depth 0.5 mm maximum

# SwitchNet™ L6 Series Control Units

## Dimensions

- Pushbutton
- Pilot Light
- Illuminated Pushbutton

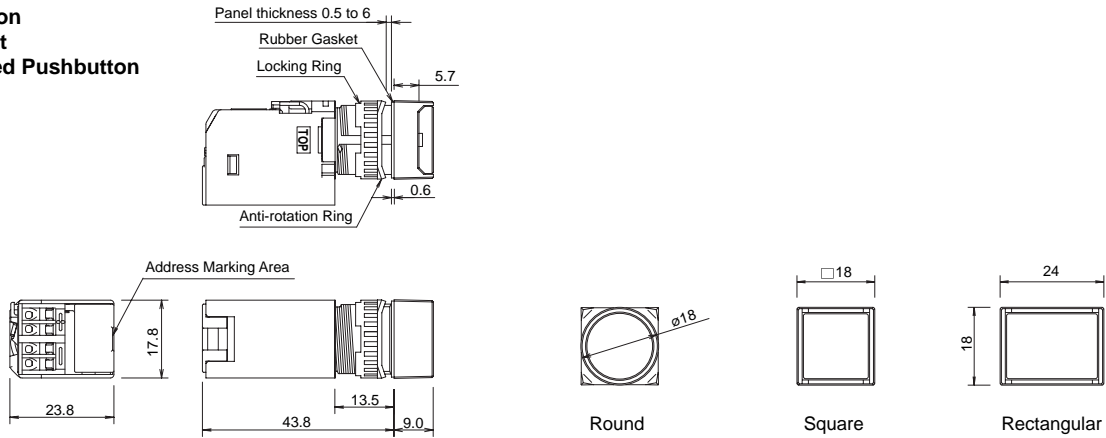

- Selector Switch
- Illuminated Selector Switch

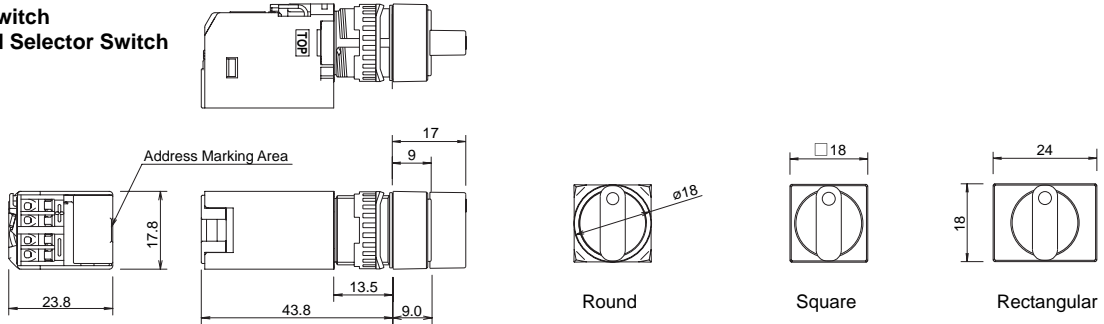

- Key Selector Switch

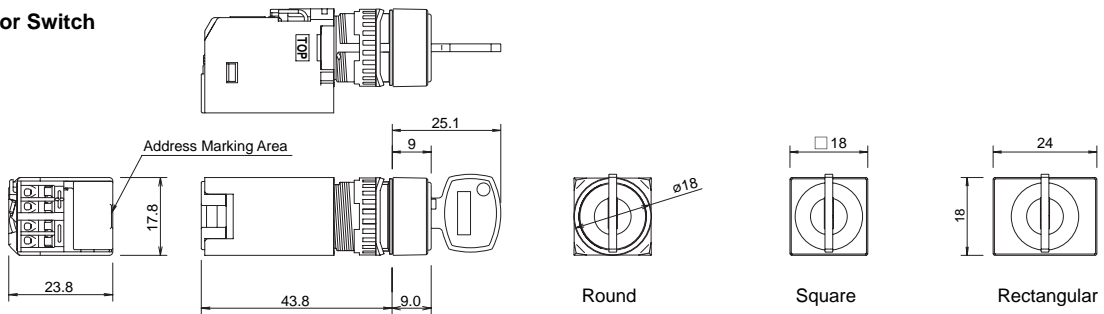

- Lever Switch

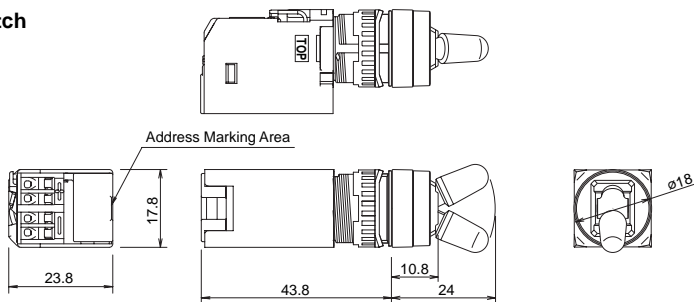

All dimensions in mm.

# SwitchNet™ L6 Series Control Units

## Dimensions of Accessories

### • Switch Guard

For Round/Square Units (AL-K6SP) For Rectangular Units (AL-KH6SP)

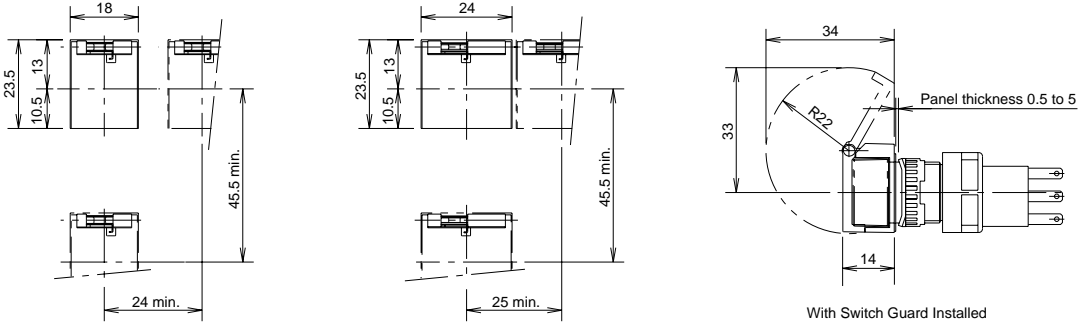

### • Dustproof Cover

For Round Units (AL-D6)

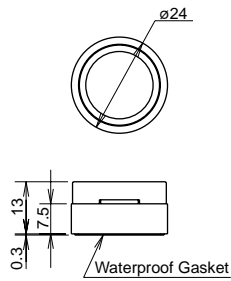

For Square Units (AL-DQ6)

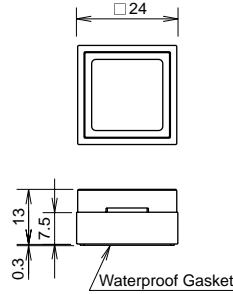

For Rectangular Units (AL-DH6)

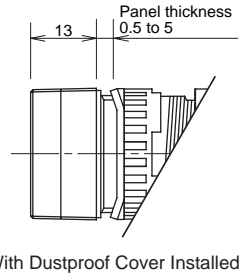
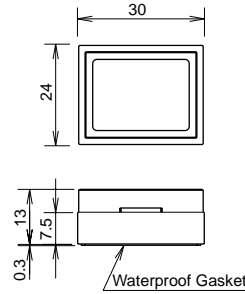

## Minimum Mounting Centers

### • Round/Square Units

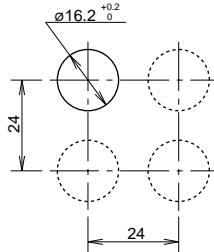

### • Rectangular Units

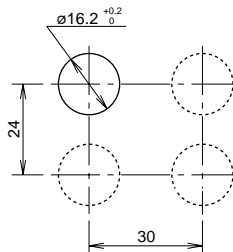

Determine the mounting centers in consideration of easy operation.

All dimensions in mm.

## Wiring

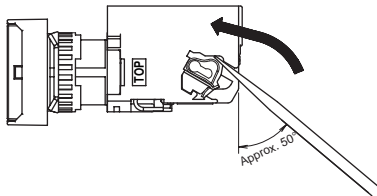

Locate the wire hole in the back of the communication contact block. To open the spring clamp in the wire hole, insert an optional screwdriver (BC1S-SD0) diagonally into the adjoining screwdriver hole until it hits the bottom. Slightly jerk the screwdriver to insert easily.

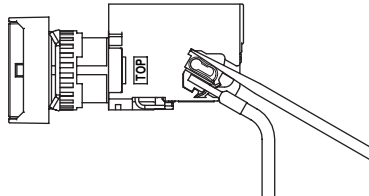

With the screwdriver held in the hole, insert a wire or ferrule to the bottom of the wire hole, then pull out the screwdriver. If an excessive force (normal operating force: 20 to 30N) is applied to the contact block while the L6 control unit is mounted on a panel, the communication block may be damaged. If the spring clamp does not open easily, remove the communication block from the operator and try again.

### • Applicable Screwdriver Tip

Screwdriver Tip According to DIN5264

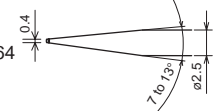

### • Terminal Arrangement

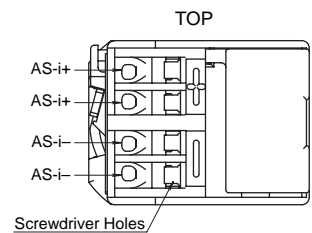

# Operating Instructions

## MicroSmart AS-Interface Master Module

### Installation Location

- The MicroSmart modules must be installed correctly for optimum performance.
- The MicroSmart is designed for installation in a cabinet. Do not install the MicroSmart outside a cabinet.
- The environment for using the MicroSmart is "Pollution degree 2." Use the MicroSmart in environments of pollution degree 2 (according to IEC 60664-1).
- Make sure that the operating temperature does not drop below 0°C or exceed 55°C. If the temperature does exceed 55°C, use a fan or cooler.
- Mount the MicroSmart on a vertical plane.
- To eliminate excessive temperature build-up, provide ample ventilation. Do not install the MicroSmart near, and especially above, any device which generates considerable heat, such as a heater, transformer, or large-capacity resistor. The relative humidity should be above 30% and below 95%.
- The MicroSmart should not be exposed to excessive dust, dirt, salt, direct sunlight, vibrations, or shocks. Do not use the MicroSmart in an area where corrosive chemicals or flammable gases are present. The modules should not be exposed to chemical, oil, or water splashes.

### Cable Connection

- Caution** • Make sure that the operating conditions are within the specification values.
- Connect the ground terminal of the CPU module to a proper ground, otherwise electric shock may occur.
  - Do not touch live terminals, otherwise electric shock may occur.
  - Applicable ferrules, crimping tool, and screwdriver are listed below.
  - When using ferrules, insert a wire to the bottom of the ferrule and crimp the ferrule.
  - When connecting a stranded wire or multiple wires to a screw terminal block, use a ferrule, otherwise the wire may slip off the terminal block.
- Ferrules for Terminal Block**
- Cross-section 0.5 mm<sup>2</sup>  
 For 1-cable connection: AI 0,5-8 WH  
 For 2-cable connection: AI-TWIN 2x0,5-8 WH
- Cross-section 0.75 mm<sup>2</sup>  
 For 1-cable connection: AI 0,75-8 GY  
 For 2-cable connection: AI-TWIN 2x0,75-8 GY
- Cross-section 1.5 mm<sup>2</sup>  
 For 1-cable connection: AI 1,5-8 BK
- Crimping Tool**  
 CRIMPFOX ZA 3 (Phoenix Contact)
- Screwdriver**  
 SZS 0.6x3.5 (Phoenix Contact)
- Screw Tightening Torque**  
 AS-Interface connector terminal screws: 0.5 to 0.6 N·m  
 AS-Interface connector mounting screws: 0.3 to 0.5 N·m

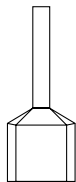

Recommended ferrules shown above are made by Phoenix Contact.

### AS-Interface Cable Wiring

- Before wiring the AS-Interface cable, remove the AS-Interface cable terminal block from the AS-Interface cable connector on the AS-Interface master module.
- AS-Interface specifies use of brown cables for the AS-i+ line, and blue cables for the AS-i- line. Connect the cables according to the colors indicated on the terminal block. Tighten the terminal screws to a torque of 0.5 to 0.6 N·m. (Replacement terminal block: FC4A-PMT3PN02, package quantity: 2)
- Insert the terminal block to the connector on the AS-Interface master module, and tighten the mounting screws to a torque of 0.3 to 0.5 N·m.

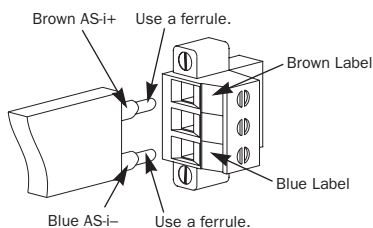

## PS2R AS-Interface Power Supply

### Precautions for Installation



#### 1. Heat Dissipation by Convection

Keep minimum spacings of 50 mm above and below, and 15 mm on both sides to ensure proper ventilation.

#### 2. Applicable Wires, Ferrules, and Tightening Torque

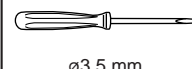
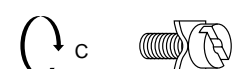

Ferrule/Wire	Single	Double	Single	Single	Double
mm <sup>2</sup>	0.14 to 1.5	0.14 to 0.75	0.14 to 2.5	0.14 to 4	0.14 to 1.5
AWG	26 to 16	26 to 18	26 to 14	26 to 12	26 to 16

 ø3.5 mm			0.6 N·m 5.4 in·lbs
--	---	---	-----------------------

#### 3. Mounting on 35- and 75-mm-wide DIN Rails

##### [Mounting]

To mount the power supply on a DIN rail, place the input terminal side up and put the groove of the power supply on the DIN rail as shown. Press the power supply towards the DIN rail.

##### [Removing]

Insert a flat screwdriver into the slot in the clamp. While pulling out the clamp, turn the power supply bottom out.

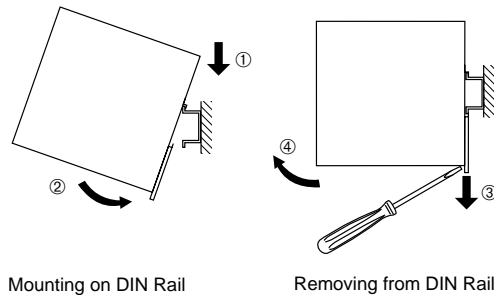

##### • Mounting Direction

The AS-Interface power supply can be mounted on a vertical plane only. Other mounting directions are not allowed because of heat dissipation.

##### • Overvoltage Protection

When an overcurrent of 110% the rated output current flows due to an overload, the output voltage drops automatically and intermittent operation starts.

When the load returns to normal conditions, the normal output voltage is automatically restored. Prevent overload or short-circuiting for a long period of time, otherwise the internal elements will deteriorate and be damaged.

##### • Overvoltage Protection

When the output voltage exceeds 120% the rated output voltage, the output is turned off. When the output voltage is turned off due to an overvoltage, turn the input off, and after more than 10 seconds, turn the input on again.

##### • Undervoltage Protection

When the output voltage drops below 95% the rated output voltage, the output is turned off. When the cause of the error is removed, the normal output voltage is automatically restored.

##### • Insulation/Dielectric Tests

When performing insulation and dielectric strength tests, connect the AC input terminals together and output + and - terminals together. Do not apply or interrupt the voltage suddenly, otherwise a surge voltage may damage the power supply.

# Operating Instructions

## SwitchNet™ HW Series Control Units

### Panel Mounting

Remove the communication block from the operator. Insert the operator into the panel cut-out from the front, then install the communication block to the operator.

#### • Removing/Installing the Communication Block

Turn the locking lever on the communication block in the direction opposite to the arrow on the housing. Then the communication block can be removed.

To install the communication block, align the TOP markings on the communication block and the operator, and insert the communication block. Then, turn the locking lever in the direction of the arrow.

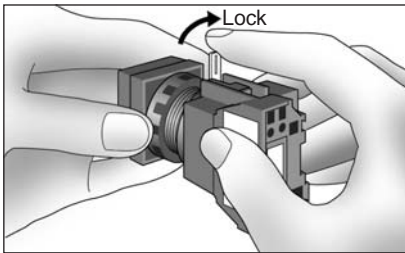

#### • Notes for Panel Mounting

When mounting the operator onto a panel, use the optional locking ring wrench (MW9Z-T1) to tighten the locking ring. Recommended tightening torque is 2.0 N-m. Do not use pliers. Excessive tightening will damage the locking ring.

On pilot lights and illuminated pushbuttons, do not apply an excessive force to the LED lamp installed in the unit. Otherwise the lamp base may be damaged.

#### • Notes for Illuminated Pushbuttons with Full Shroud

The full shroud cannot be removed from the full shroud type operator.

### Using the Safety Lever Lock

To make sure that the lock lever is in the locked position, use of the attached safety lever lock (HW9Z-LS, yellow) is recommended.

Use the safety lever lock according to the instructions described below.

1. The minimum vertical mounting centers of HW control units are 50 mm. Determine the mounting centers in consideration of convenience for installing the safety lever lock. (100 mm is recommended.)
2. After mounting the HW units on a panel, turn the locking lever to the locked position and put on the safety lever lock.
3. When the HW units are mounted on mounting centers smaller than the recommended distance, first put on the safety lever lock with the locking lever unlocked, and install the communication block onto the operator. Turn the lock lever into the locked position, and push down the safety lever lock into place.
4. To remove the safety lever lock, insert a screwdriver into the hole in the safety lever lock, and pull up the safety lever lock.

#### • Installing/Removing the Safety Lever Lock

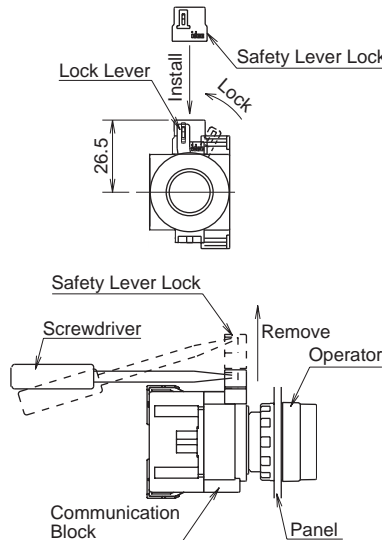

### Replacement of the Lens and Marking Plate

#### • Removing

1. To remove the lens unit (lens, marking plate, and lens holder), insert a screwdriver into the recess of the lens. Recesses are on the TOP mark side and the opposite side.

#### [Removing the Lens Unit]

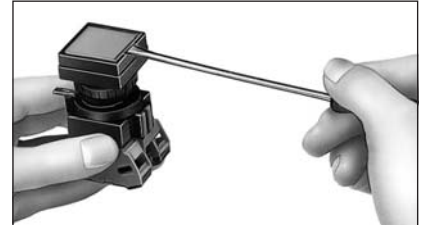

2. To remove the lens, insert a screwdriver between the lens and lens holder to disengage the latches. Then, the marking plate can be removed.

#### [Removing the Lens]

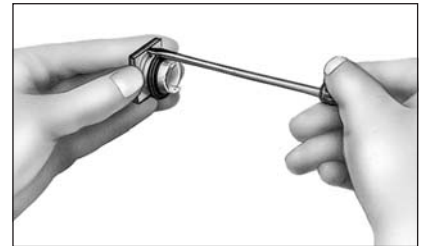

Note: The filter on the lens holder is for water-proof and oiltight purposes and cannot be removed.

#### • Installing

For round lens types, place the marking plate on the lens holder with the anti-rotation projection engaged and press the lens onto the lens holder to engage the latches. For square lens types, insert the marking plate into the lens, and press the lens onto the lens holder to engage the latches.

Pay attention to the orientation of the marking plate.

#### Round Lens Type

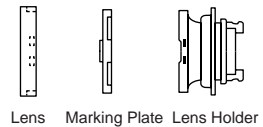

#### Square Lens Type

Note the orientation.

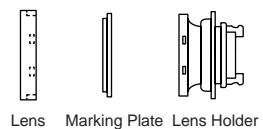

# Operating Instructions

## SwitchNet™ HW Series Control Units

### Legend Marking

For HW series pilot lights and illuminated pushbuttons, legends and symbols can be engraved on marking plates, or printed Mylar can be inserted under the lens for labelling purposes.

#### • Marking Plate and Marking Film Size

Lens Style	Round Lens Type (Flush)	Square Lens Type
Built-in Marking Plate	<p>Engraving Area ø19.6</p>	<p>Engraving Area 19.9</p>
Applicable Marking Film	<p>ø21.5 19.4</p>	<p>22.7</p>
	<ul style="list-style-type: none"> <li>Engraving must be made on the engraving area within 0.5 mm deep.</li> <li>The marking plate is made of white acrylic resin.</li> </ul>	
	<ul style="list-style-type: none"> <li>Mylar for printing labels is not included and must be provided and printed by user.</li> <li>Two 0.1-mm-thick films or one 0.2-mm-thick film can be installed in the lens.</li> <li>Recommended marking film: Mylar</li> </ul>	

#### • Insertion Order of Marking Plate and Film

##### Round Lens (Flush) Type

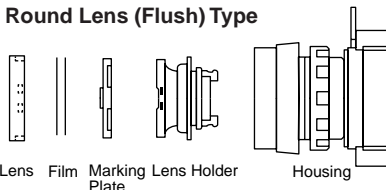

Note: Mylar is not included.

##### Square Lens (Flush) Type

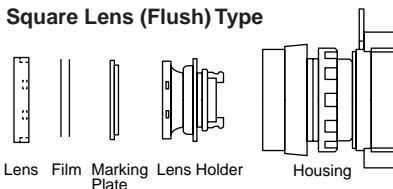

Note: Mylar is not included with the control unit. When using Mylar, place the marking plate in the reverse direction.

### Replacement of LED Lamps

LED lamps can be replaced using the lamp holder tool (OR-55) from the front of the panel. The lamp can also be replaced by removing the communication block from the operator unit.

#### • Replacement of Lamps from Panel Front

##### [How to Remove]

Push in and turn the LED lamp counter-clockwise using the lamp holder tool, then the LED lamp can be removed.

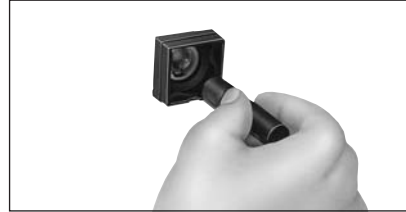

##### [How to Install]

1. Insert the LED lamp into the lamp holder tool and hold the lamp as shown below.

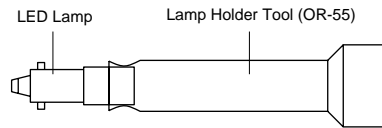

2. Align the contact pins of the lamp base with the grooves in the lamp receptacle in the operator unit, then push in the LED lamp lightly and turn it clockwise into place.

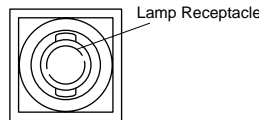

### Wiring

1. Locate the wire hole in the back of the communication contact block. To open the spring clamp in the wire hole, insert an optional screwdriver (BC1S-SD0) into the adjoining screwdriver hole until it hits the bottom. Slightly jerk the screwdriver to insert easily.

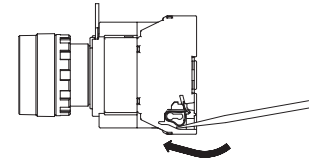
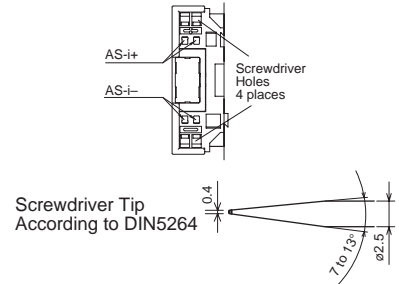

2. With the screwdriver held in the hole, insert a wire or ferrule to the bottom of the wire hole, then pull out the screwdriver.

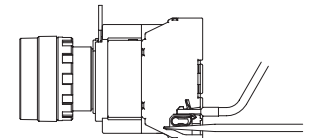

Strip the cable insulation 6 to 8 mm from the end.

### Anti-rotation Ring

When using the anti-rotation ring, align the TOP marking on the operator and the ▲ mark on the anti-rotation ring with the recess in the mounting hole.

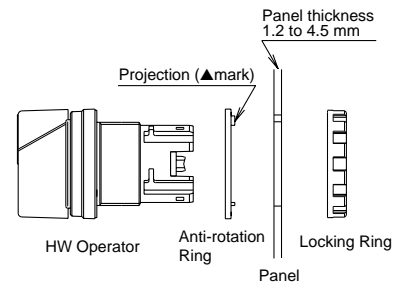

### Panel Cut-out (IEC 947-5-1)

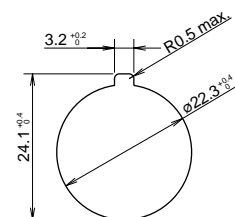

For addressing procedures, see page 28.

# Operating Instructions

## SwitchNet™ L6 Series Control Units

### Replacement of the Lens and Marking Plate

#### • Removal

To remove the operator (color lens, marking plate, and lens holder), hold the color lens recesses with the lens removal tool (MT-101) and pull it out. Remove the marking plate by disengaging the latches between the color lens and lens holder. Engrave a legend on the correct side of the marking plate, if required.

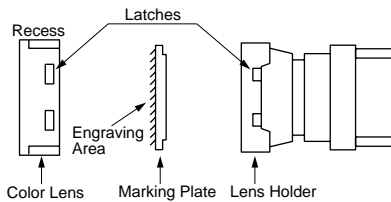

#### • Installation

Place the marking plate on the lens holder in the correct direction, and press the color lens onto the lens holder to engage the latches. Insert the lens holder into the housing in the correct direction.

### Replacement of LED Lamps

Lamps can be replaced using the lamp holder tool (OR-44) from the front of the panel. The lamp can also be replaced by removing the communication block from the operator unit.

#### • Replacement from Panel Front

##### [Removal]

1. Push and turn the LED lamp counter-clockwise using the lamp holder tool, then the LED lamp and the lamp holder can be removed.

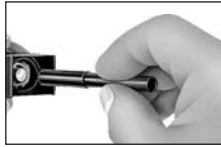

2. Push in the lamp head into the lamp holder, and pull out the LED lamp from the rear of the lamp holder.



##### [Installation]

1. First, insert the LED lamp into the lamp holder from the rear. The lamp can be pushed in easily using the thinner end of the lamp holder tool.
2. Hold the LED lamp in the lamp holder tool as shown below.

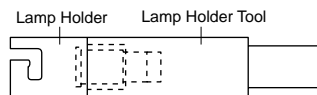

3. Insert the LED lamp into the communication block. With the slit in the lamp holder aligned with the contact pin inside, push in and turn clockwise until the lamp holder is retained.

### Panel Mounting

Remove the communication block from the operator. Insert the operator into the panel cut-out from the front, then install the communication block to the operator.

#### • Removing/Installing the Communication Block

With the yellow lever stop depressed in the direction of ①, turn the lock lever in the direction of ② (opposite to the arrow on the communication block), and pull out the communication block.

To install, align the TOP markings on the operator and the communication block together, insert the operator into the communication block, and turn the lock lever in the direction of ③ (the arrow on the communication block).

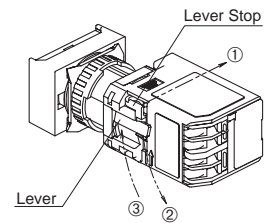

#### • Notes for Panel Mounting

Use the optional ring wrench (MT-001) to mount the operator onto a panel. Tighten the locking ring to a recommended torque of 0.88 N·m. Use of pliers or excessive tightening will damage the locking ring.

For addressing procedures, see page 28.

## Precautions for AS-Interface Wiring (Common Notices)

1. Do not run the AS-Interface network cables in parallel with or near power lines. Keep the cables away from noise sources.
  2. Turn power off before starting wiring. After wiring, confirm that wiring is connect before turning power on.
  3. For wiring, use cables appropriate for each slave as listed in the table below.
- Cables applicable to slaves can also be used for the AS-Interface master module and AS-Interface power supply.
  - For SwitchNet slaves (HW and L6 units), single wires can also be used for connection over short distances: stranded wires 0.5 to 0.75 mm<sup>2</sup> (AWG20 to 18) or solid wires 0.5 to 1.5 mm<sup>2</sup> (AWG20 to 16).

Slave	Applicable Cable	Cable Type No.	Manufacturer	Remarks
SwitchNet HW/L6 all models SX5A AS-Interface I/O Module IP20 type	2-core parallel cable			
SX5A AS-Interface I/O Module all models	AS-Interface Flat Cable	Yellow (data and power)	2170 228	LAPP Sheath material: EPDM
		Black (auxiliary power)	2170 229	

Note: Do not use twisted cables and do not twist single cables together.

4. When using a ferrule on a stranded wire for wiring SwitchNet slaves (HW and L6 units) or T-branch connectors, use the ferrule shown in the table below. If a stranded wire of 0.75 mm<sup>2</sup> or AWG18 is connected without using a ferrule, the wire tensile strength reduces.

Cable Size (Stranded Wire)	Ferrule Type (Phoenix)	Order No.	Pcs./Pkt.
0.5 mm <sup>2</sup> (AWG20)	AI 0,5-8 WH	32 00 01 4	100
0.75 mm <sup>2</sup> (AWG18)	AI 0,75-8 GY	32 00 51 9	100

5. The maximum total cable length is 100m, including all network cables. The maximum cable length can be extended to 200m using one repeater, or to 300m using two repeaters.
6. AS-Interface does not require a terminator.
7. Slave module address is set to 00 before shipment from factory.
8. Network error causes include:
  - Disconnected or shorted network cable
  - Strong external noise
  - Dropped power voltage for the master and slaves below the minimum power voltage.
  - Use of an improper network cable

# MICROSmart Micro Programmable Logic Controller

All-in-one and slim type CPU modules  
Powerful communication functions and flexible system expansion



WindLDR Ver. 4.21  
Programming and Monitoring



For details about the MicroSmart, see the catalog.

## • CPU Modules

Type	Type No.	I/O Points
All-in-One	FC4A-C10R2	6 in / 4 out
	FC4A-C16R2	9 in / 7 out
	FC4A-C24R2	14 in / 10 out
Slim	FC4A-D20K3	12 in / 8 out
	FC4A-D20S3	12 in / 8 out
	FC4A-D20RK1	12 in / 8 out
	FC4A-D20RS1	12 in / 8 out
	FC4A-D40K3	24 in / 16 out
	FC4A-D40S3	24 in / 16 out

## • I/O Modules

Module	I/O Points	Models
Input	8 inputs	1
	16 inputs	2
	32 inputs	1
Output	8 outputs	3
	16 outputs	3
	32 outputs	2
I/O	4 in / 4 out	1
	16 in / 8 out	1
Analog	2 in / 1 out	2
	2 inputs	1
	1 output	1

## • AS-Interface Master Module

Type No.	AS-i Version
FC4A-AS62M	Ver. 2.1

## • Option

Type No.	Models
HMI Module	1
HMI Base Module	1
Communication Adapter	3
Communication Module	3
Memory Cartridge	1
Clock Cartridge	1



## PS5R Switching Power Supply

IP20 finger-safe spring-up terminals  
DIN rail mounting, AC universal input voltage



Output	Type No.	Input Voltage	Output Voltage	Remarks
7.5W	PS5R-A①	100 to 240V AC (85-264V AC/105-370V DC compatible)	12 or 24V DC	Limit for Harmonic Current Emissions (EN 61000-3-2) compliant
15W	PS5R-B①			
30W	PS5R-C①			
50W	PS5R-D24			
100W	PS5R-E24	100 to 200V AC (85 to 132V AC) 200 to 240V AC (170-264A AC/240-370VDC)	24V DC	Limit for Harmonic Current Emissions (EN 61000-3-2) compliant
75W	PS5R-Q24			
120W	PS5R-F24			
240W	PS5R-G24			

Specify an output voltage code in place of ①.

Output Voltage	Code
12V DC	12
24V DC	24



## ⚠ Safety Precautions

- All IDEC AS-Interface devices are manufactured under IDEC's rigorous quality control system, but users must add a backup or failsafe provision to the control system using the device in applications where heavy damage or personal injury may be caused in case the device should fail.
- Turn off the power to the device before starting installation, removal, wiring, maintenance, and inspection of the device. Failure to turn power off may cause electric shocks or fire hazard.
- Use a power supply and I/O devices of the rated value, otherwise fire hazard may occur.
- Special expertise is required to install, wire, program, and operate the AS-Interface devices. People without such expertise must not use the AS-Interface devices.
- Read the user's manual or operating instruction sheet attached to the product to make sure of correct operation.

Specifications and other descriptions in this catalog are subject to change without notice.



## IDEC IZUMI CORPORATION

**IDEC CORPORATION (USA)**  
1175 Elko Drive, Sunnyvale, CA 94089-2209, USA  
Tel: +1-408-747-0550, Toll Free: (800) 262-IDECC, Fax: +1-408-744-9055  
E-mail: opencontact@idec.com, www.idec.com

**IDEC CANADA LIMITED**  
Unit 22-151, Brunel Road Mississauga, Ontario, L4Z 1X3, Canada  
Tel: +1-905-890-8561, Toll Free: (888) 317-4332, Fax: +1-905-890-8562

**IDEC ELECTRONICS LIMITED**  
Unit 2, Beechwood, Chineham Business Park, Basingstoke, Hampshire RG24 8WA, UK  
Tel: +44-1256-321000, Fax: +44-1256-327755  
E-mail: idec@uk.idec.com

**IDEC ELEKTROTECHNIK GmbH**  
Wendenstraße 331, D-20537 Hamburg, Germany  
Tel: +49-40-25 30 54-0, Fax: +49-40-25 30 54-24  
E-mail: service@idec.de, www.idec.de

**IDEC AUSTRALIA PTY. LTD.**  
2/3 Macro Court, Rowville, Victoria 3178, Australia  
Toll Free: 1-800-68-4332, Fax: +61-3-9763-3255  
E-mail: sales@au.idec.com

7-31, Nishi-Miyahara 1-Chome, Yodogawa-ku, Osaka 532-8550, Japan  
Tel: +81-6-6398-2571, Fax: +81-6-6392-9731  
www.idec.com

**IDEC IZUMI ASIA PTE. LTD.**  
No. 31, Tannery Lane #05-01, Dragon Land Building, Singapore 347788  
Tel: +65-6746-1155, Fax: +65-6844-5995  
E-mail: generalinfo@idecasia.com.sg

**IDEC IZUMI (H.K.) CO., LTD.**  
Room 1409, Tower 1, Silvercord, 30 Canton Road, Tsimshatsui, Kowloon, Hong Kong  
Tel: +852-2-376-2823, Fax: +852-2-376-0790  
E-mail: idec@idechk.com

**IDEC IZUMI (Shanghai) Co., Ltd.**  
Room E, 15F, Majesty Building, No. 138 Pudong Avenue, Shanghai 200120, P.R.C.  
Tel: +86-21-5887-9181, Fax: +86-21-5887-8930  
E-mail: idec@cn.idec.com

**IDEC TAIWAN CORPORATION**  
8F, No. 79, Hsin Tai Wu Road, Sec. 1, Hsi-Chih, Taipei County, Taiwan  
Tel: +886-2-2698-3929, Fax: +886-2-2698-3931  
E-mail: service@idectwn.com.tw