

### Manual brazing workplace

IBU105 (Induction Brazing Unit – 1 x TTH5t 5kW)

Scope of work: Induction soldering of honing tools

This assembly is a manual brazing workplace for the soldering of honing tools utilizing a soldering alloy.

The single components of the honing tool are placed within the soldering device with an inductor especially designed for this application. Moreover, this soldering device also consists of a temperature control ensuring an accurate temperature gradation, ultimately leading to a consistent tool quality. Via the integrated cooling device (air cooling), the liquidus phase of the solder during cooling can be minimized. If needed, this assembly can naturally be equipped with a shielding gas unit.

The utilization of honing tools often describes the last production process of a fine machining treatment and can be applied to nearly every material. It is the goal to positively influence the dimensional accuracy, thus minimizing the frictional resistance

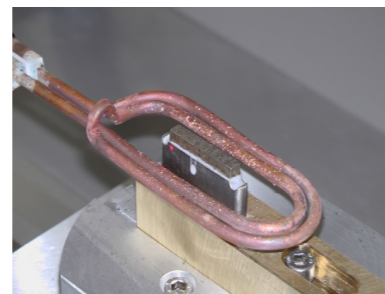
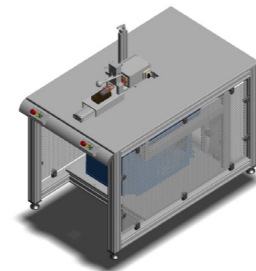

**You Tube**

<http://www.iew.eu/en/products/brazing-units/>

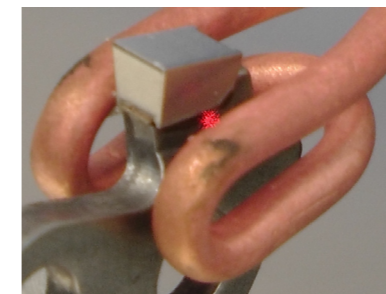
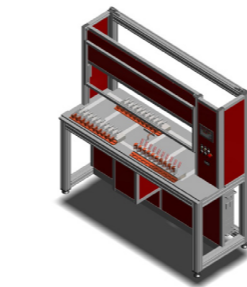
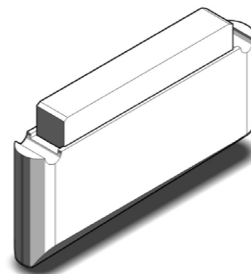

**You Tube**

<http://www.iew.eu/en/products/brazing-units/>

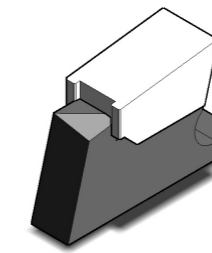

### Manual brazing workplace

IBU105 (Induction Brazing Unit – 1 x TTH5 5kW)

Scope of work: Induction brazing of saw teeth onto chain links

This assembly is a semiautomatic brazing workplace for the inductive brazing of saw teeth onto chain links.

Thereby, a staff member assembles a product carrier with 10 chain links, adds the saw teeth together with the brazing foil and finally fixes them in a retainer jaw. After closing the fixation, the carrier plate is positioned behind a manually lockable safety glass. The following brazing process starts automatically and the 10 brazing joints are clocked one after another, utilizing a carriage system and an open fork inductor. The completion of the brazing process is followed by an acoustic signal.

The assembly naturally features a PLC as well as a contact-free temperature measuring system (infrared-pyrometer). The carrier plate comes up with an integrated water cooling system to ensure stable brazing conditions.

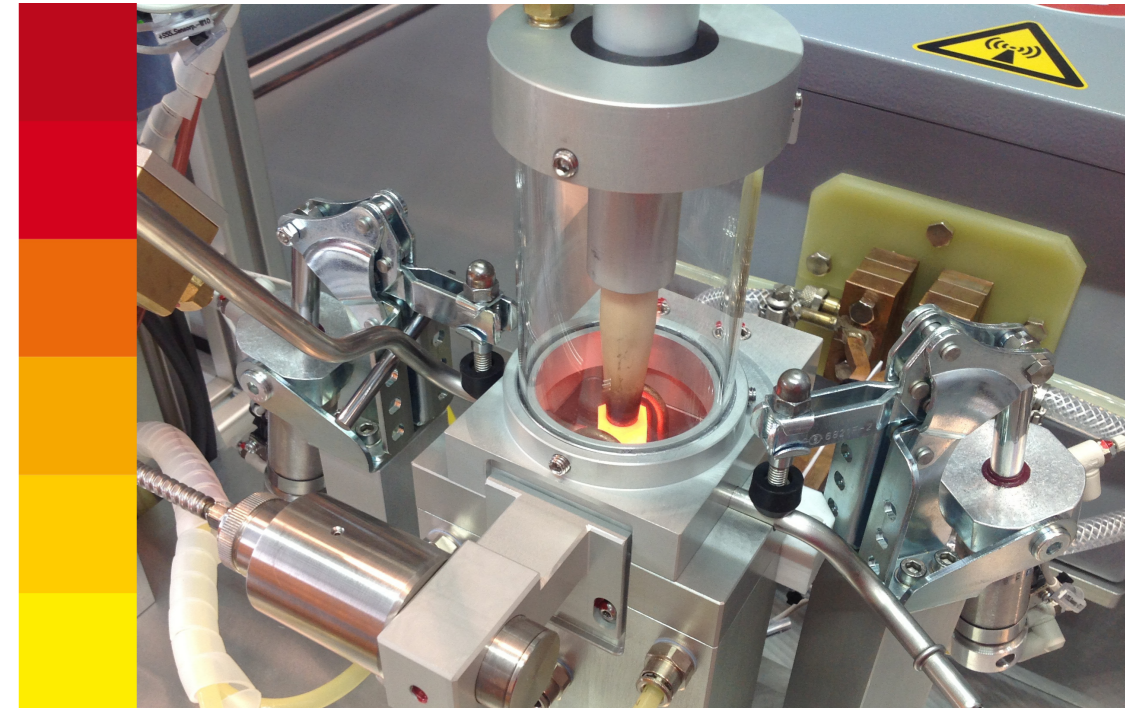

**Induction brazing assemblies  
Protection gas induction brazing assemblies**

**Manual and automatic systems**

iew Induktive Erwärmungsanlagen GmbH  
[www.iew.eu](http://www.iew.eu)

Stand: 14 09 2014

## Roundtable

IRT210 (Induction Round Table – 2 x TTH10 10kW)

Scope of work: Induction brazing of stainless steel tubes in the automotive industry

This induction round table was especially developed for the brazing of ball-type nipples onto stainless steel tubes with protective gas.

The operational procedure can be summarized as follows: A staff member inserts a new assembly group with an already mounted ball-type nipple. The ball-type nipple is brazed onto the steel tube during the first cycle, automatically rotated by 180° and then completed, after the staff member mounted the second ball-type nipple with a copper brazing preform. There are always two steel tubes in front of the operator, one for the first and one for the second brazing joint. The induction round table consists of 12 double stations.

Furthermore, the brazing assembly is equipped with a system that automatically discharges steel tubes that do not meet the prior defined brazing parameters. This prevents that n.i.o. parts are further processed. This induction round table can realise more than 2.5 million brazing joints per year.

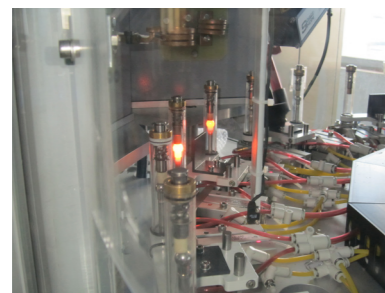
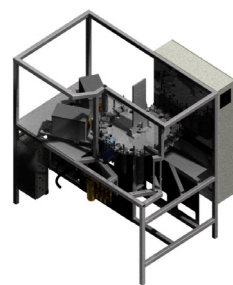

YouTube

<http://www.iew.eu/en/products/brazing-units/>

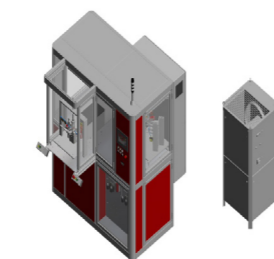
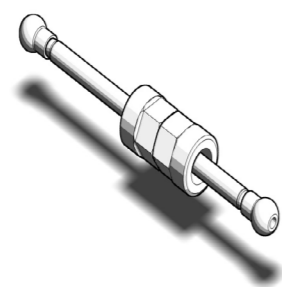

## Manual brazing workplace

IBU115 (Induction Brazing Unit – 1 x TTH15 15kW)

Scope of work: Induction brazing of stainless steel tubes in the automotive industry

This brazing workplace has been equipped with a protection gas unit and has been designed for the inductive brazing of stainless steel tubes and turned/milled parts in the shape of T- and pipe fittings.

The operator manually inserts the single components and activates a clamping tool via a two hand activator. The brazing assembly naturally comes with a RFID component identification. This ensures that the customer specific brazing program is chosen and all product-dependent parameters regarding the protection gas unit are initialized. Preparation- and type errors can thereby be eliminated. The brazing assembly has been designed for a five-day working week in a three shift working pattern for 30.000 parts a year with 2 brazing joints each. The PLC interface always displays the current brazing process and supervises every single assembly step. Furthermore, the corresponding temperature profile is graphically displayed. The brazing parameters are saved within a loc-file (Name of operator, temperatur profile, maximum temperature, amount of protection gas, etc.).

The device was designed in a way that allows an alteration of the product line. To achieve this, only the customer specific product carries has to be altered. Thereby, the operation of the IBU115 is warranted for years.

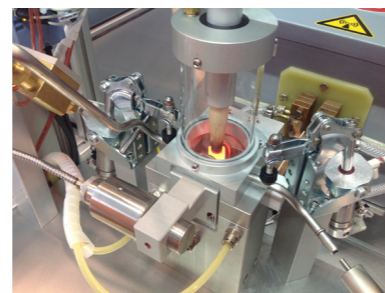

YouTube

<http://www.iew.eu/en/products/brazing-units/>

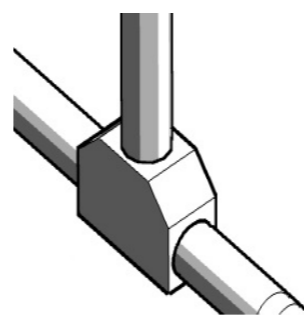

## Manual brazing workplace

IBU220 (Induction Brazing Unit – 2 x TTH20 20kW)

Scope of work: Research and development regarding induction heating

The IBU220 was especially designed for brazing and hardening processes in the research and development.

This workplace consists of two 20kW generators and the corresponding heating station with pre-assembled inductors and an electric lifting system with 300mm traverse way. Due to the desired flexibility in the research and development, this assembly has not been outfitted with a set equipment, instead it can be altered depending on the test series. This device has also been equipped with a protection gas unit. Since this device also features a PLC, both induction units can be triggered separately. Additionally, successive heating processes can be realised (Brazing unit 1 done -> Automatic start of brazing unit 2 and vice versa).

This leads to the highest possible flexibility regarding the heat treatment.



YouTube

<http://www.iew.eu/en/products/brazing-units/>

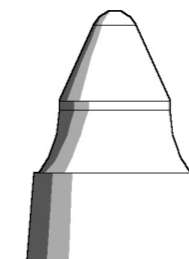

## Manual brazing workplace

IBU105 (Induction Brazing Unit – 1 x TTH5t 5kW)

Scope of work: Induction brazing of carbide metal- / PCD- / PCBN- / CBN- tools

This workplace has been constructed for the inductive brazing of carbide metals as well as PCD-, PCBN-, and CBN tools.

Thereby, the operator inserts the single components into the brazing device and moves them into a closed, respectively open inductor. The herein described workplace was naturally equipped with a temperature control (infrared-pyrometer) to prevent possible thermal damage (graphitization) of the diamond. Of course, this brazing device can also be equipped with a protection gas unit.

For this special customer order we also integrated a shower to simultaneously harden the workpiece. In combination with the infrared pyrometer, the PLC initializes a hardening shower after the brazing filler metal reaches the solidus temperature. However, this hardening process cannot be compared to regular hardening processes (Hardening normally at approx. 1000 °C / Brazing in this case 700 °C) but nonetheless leads to an increased hardness of the workpiece.

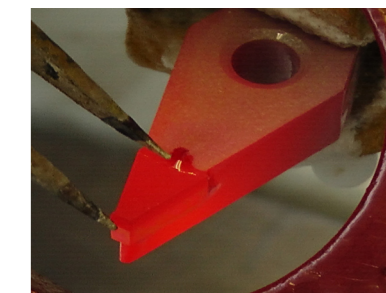
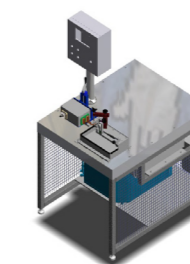

YouTube

<http://www.iew.eu/en/products/brazing-units/>

