

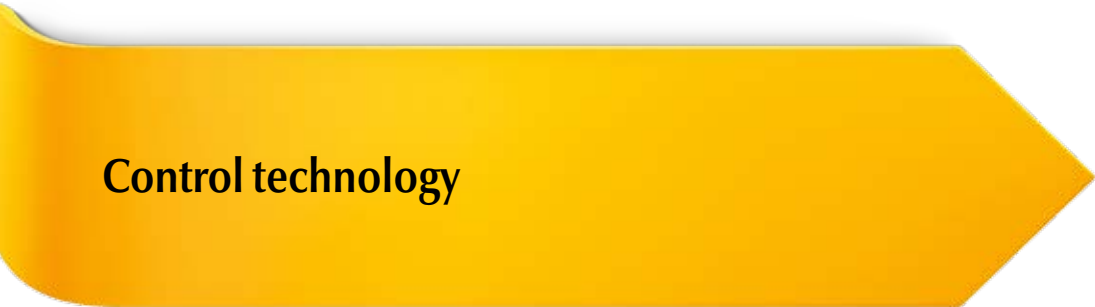

Visualisation; Diagnostics

Easy to Configure

Programming IEC



## Control technology



- ▶ Electronic monitoring relays PMDsigma and PMDsrangle
- ▶ Safety relays PNOZsigma, PNOZ X, PNOZcompact, PNOZelog and PNOZpower
- ▶ Configurable control systems PNOZmulti 2, PNOZmulti Mini, PNOZmulti
- ▶ Control systems and I/O systems PSSuniversal





## COMPONENTS

Sensor, control and drive technology

## SYSTEMS

Automation systems

**The 4-fold safety of automation**

### Technical

Put your trust in innovative products and tailor-made solutions

### Personal

Rely on professional advice and individual care

### Ecological

Build on energy-efficient products and environmentally friendly applications

Pilz is your solution supplier for all automation tasks. Including standard control functions. Pilz developments protect man, machine and the environment.

Pilz has a tradition as a family-run company stretching back over 60 years. Real proximity to customers is visible in all areas, instilling confidence through individual consultation, total flexibility and reliable service. Worldwide, round the clock, in 31 subsidiaries and branches, as well as 21 sales partners on every continent.

More than 1 900 staff, each one of them an ambassador for safety, make sure that your company's most valuable asset – your staff – can work safely and free from injury.



Further information:  
[www.pilz.com](http://www.pilz.com) +  
Webcode: web0837

S  
ems

## SERVICES

Consulting, engineering  
and training

ical  
ergy-efficient  
and environmentally-  
lications

**Economical**  
Count on efficient production and  
the security of investment provided  
by our system solutions

**pilz**  
the spirit of safety

Automation  
solutions from Pilz –  
at home in every  
industry.





Pilz control technology –  
for safety and automation.

# ► Control technology

Pilz offers the right solution for every control technology situation. From stand-alone applications to networked and distributed systems – for safety and automation. Resolve your automation function economically, safely and from one source with compatible components and systems: from simple monitoring relays PMD to safety relays PNOZ, the configurable control systems PNOZmulti and the programmable control systems PSSuniversal PLC. As a result, a large number of applications can be implemented in compliance with the standards. Our software tools enable simple handling and make commissioning easier. Combine that with network components and software and you get complete automation architectures. Extensive diagnostic options mean you can benefit from short downtimes and high plant availability.

## Contents

<b>Automation: complete and simple!</b>	6	<b>Product group: configurable control systems PNOZmulti</b>	56
<b>Control technology product area</b>	8	► Configurable control systems PNOZmulti 2	60
<b>Product group: monitoring relays PMD</b>		► Configurable small control systems PNOZmulti Mini	68
► Electronic monitoring relays PMDsigma	10	► Configurable safety systems PNOZmulti	74
► Electronic monitoring relays PMDsrange	12	► Software tool PNOZmulti Configurator	84
<b>Product group: safety relay PNOZ</b>		► Accessories	86
► Safety relay PNOZsigma	18	<b>Product group: decentralized modules PDP67 and PDP20</b>	88
► Safety relay PNOZ X	30	► Cable navigator	90
► Safety relay PNOZcompact	38	<b>Product group: control systems and I/O systems PSSuniversal</b>	92
► Safety relay PNOZelog	40	► Control systems and I/O systems PSSuniversal	94
► Safe line inspection device PLIDdys	48	► Control systems and I/O systems in the automation system PSS 4000	98
► Safety relay PNOZpower	50	► Accessories	108
		<b>Did you know?</b>	112
		<b>Services</b>	114
		<b>Index</b>	116

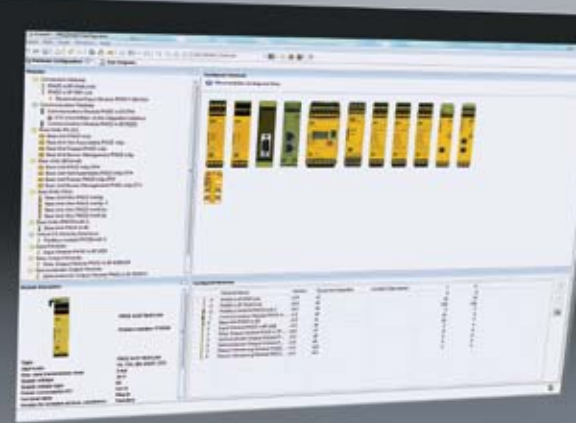

Visualisation; Diagnostics

Easy to Configure



**Pilz automation solutions – All in One: Safety & Automation**

Pilz offers you solutions for complete automation. From sensor technology to control and drive technology – with safety and automation included. On all components and systems, simple commissioning, simple handling and simple diagnostics play an important role!

Profit from flexible automation solutions for small machines or even large, networked plants. Regardless of whether you want to standardize your safety, implement safety and automation in the periphery or are looking for the solution for complete automation.

Pilz solutions are embedded into the relevant system environment –

whether a new structure or a retrofit – and open for a variety of interfaces and functionalities.

**The perfect combination:**

**Control technology** enables numerous application options, including monitoring of electrical and functional safety, through to complete machine control.



Programming IEC 61131-3

Rapid Installation

## All in One: Safety & Automation

- ▶ Full diagnostic options for reduced machine downtimes
- ▶ Open communication for high flexibility
- ▶ Innovative software solutions for easy configuration, programming and visualization
- ▶ High scalability for individual solutions
- ▶ One system for safety and automation



In combination with the various control systems, safe **sensors** and **decentralized modules** guarantee the efficient use of plant and machinery in compliance with standards. Ready-to-install systems and universally compatible solutions offer high potential savings.

In the area of **drive technology**, the offer includes drive-integrated

safety functions, safe logic functions and the connection of visualization, sensor and actuator technology.

Your plant or machinery are completed with **operator and graphics devices** from Pilz.

Design, programming, configuration, commissioning, diagnostics and visualization can be achieved

quickly and simply using Pilz **automation software**.

Pilz offers scalable solutions to suit each requirement – from sensor technology to control and drive technology.

## ► Pilz control technology – for safety and automa

The optimum solution for every requirement – with these control systems and components you can implement each application in compliance with the standards. User-friendly software provides support when implementing your automation projects. From a stand-alone machine to networked plants – with Pilz your automation can be complete and simple.

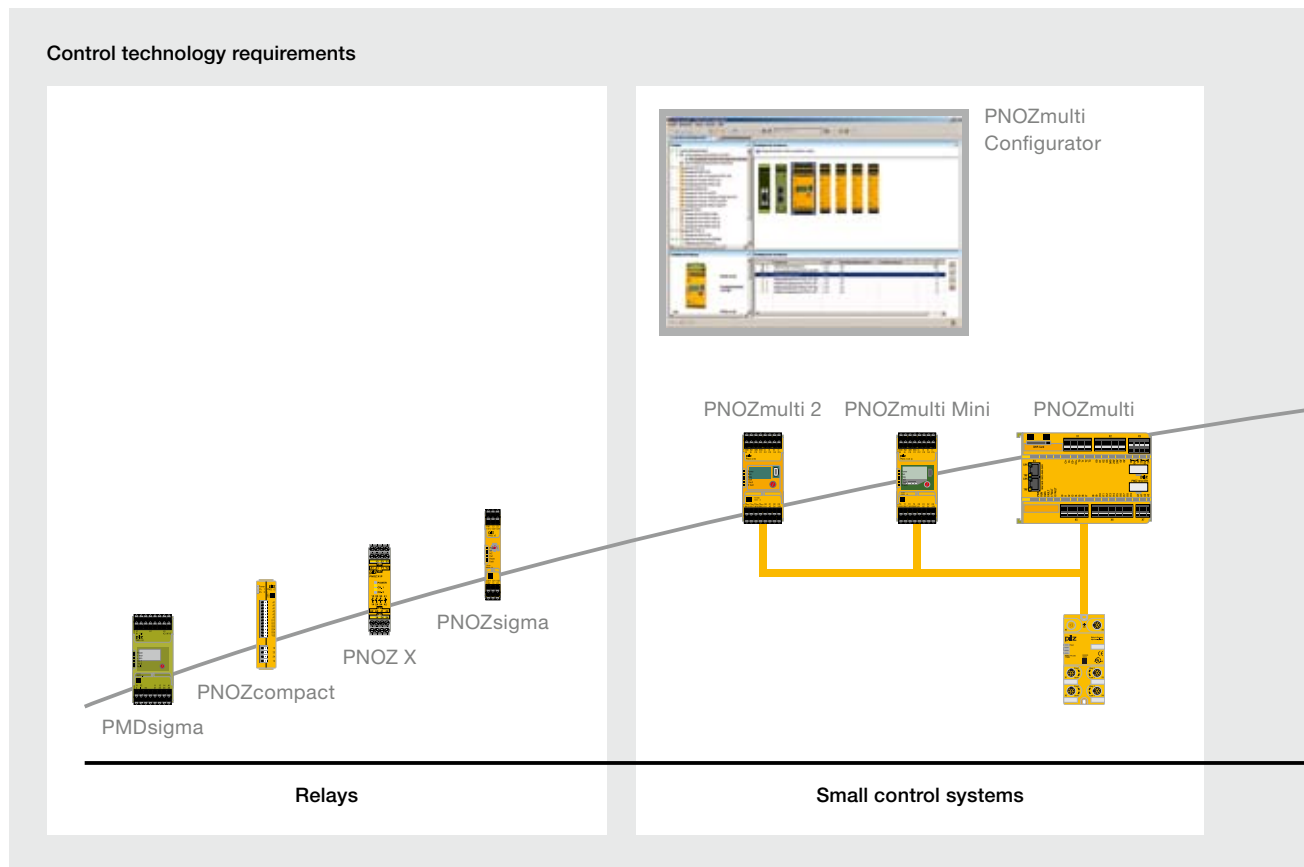

With Pilz control technology you can implement:

- Simple machines with up to three safety functions for monitoring E-STOPS, safety gates, light grids and many more
- Complex stand-alone machines with high safety requirements, such as presses, for example
- interlinked plants with a decentralized structure, such as packaging machines, for example
- Complete lines with decentralized networking, such as transfer lines, for example

Innovation is our motto! We work closely with customers to continually develop the devices and systems. Technologies such as the real-time Ethernet SafetyNET p keep opening up new prospects in control technology.

### Standards for safety

Pilz's thorough expertise in safety technology pays off. Our control systems and decentralized periphery modules meet the very highest safety requirements and thus conform to international standards for machine safety.



tion

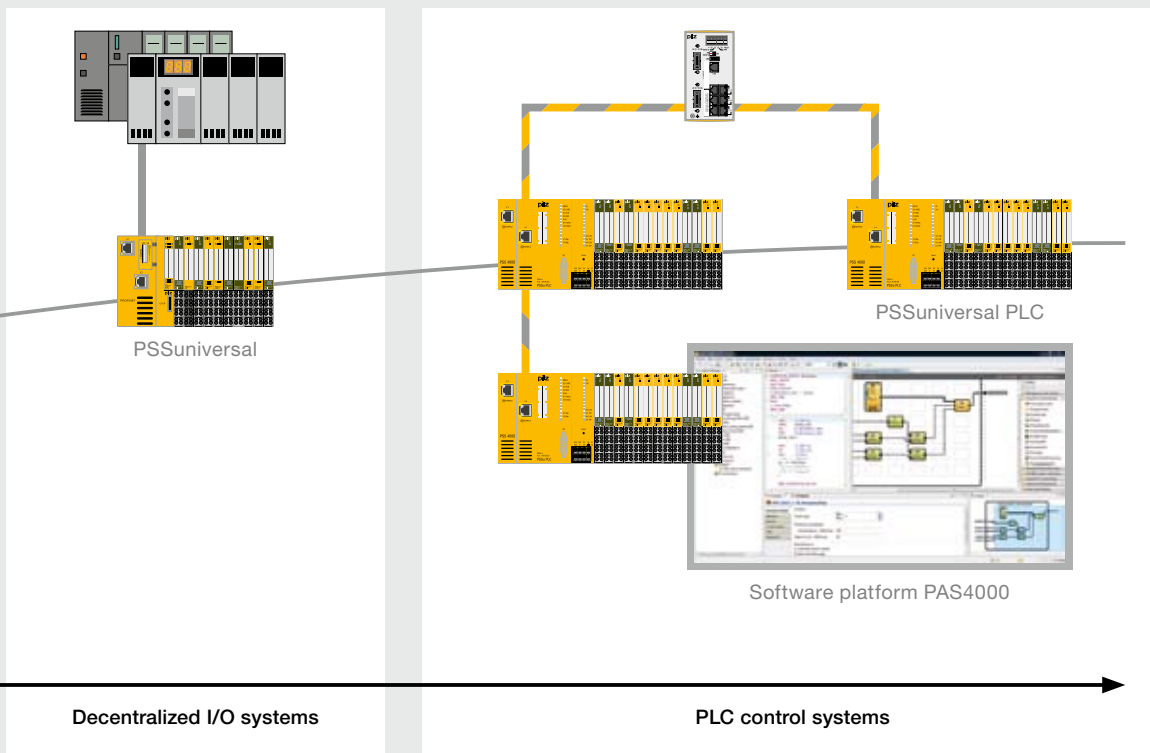

- ▶ EN/IEC 61508 up to SIL CL 3
- ▶ EN/IEC 62061 up to SIL CL 3
- ▶ EN ISO 13849-1 up to PL e

What is more, the devices conform to a wide variety of application-specific standards, which allows them to be used without problem in a huge range of applications and industries.

**Ethernet technology – remote diagnostics**

Long waiting times are a thing of the past. Thanks to the Ethernet interface of the configurable control systems PNOZmulti and the control systems PSSuniversal, remote diagnostic data can be accessed quickly and simply in a service situation. Complete networks can be built up thanks to its master functionality.

Relays

Small control systems

Decentralized I/O systems

PLC control systems

## ► Electrical safety with the electronic monitoring

On electronic monitoring relays, electrical safety is the focus. Electronic monitoring relays reduce the number of hazardous situations for man and machine and increase the service life of plant and machinery. Save costs and ensure an efficient production cycle.



PMD s10

### Applications PMD s10

Using the measured true power, it is possible to derive variables such as fill level, volume, torque or air pressure, for example. The following applications illustrate potential areas of use, by way of example:

- Contamination of sieves or filters on ventilation systems
- To check for dry running or pump blockage
- Viscosity of fluids on mixers
- Wear and tear on tools
- To control the brush pressure on car washes
- To monitor conveyors for blockages or wear and tear



### Technical details – Electronic monitoring relays PMDsigma



PMD s20

Type	Application area	Dimensions (H x W x D) in mm
PMD s10	Monitors and converts true power for single/three-phase AC/DC supplies, relay and analog outputs, monitors overload and underload. Suitable for use with frequency-controlled motors and current transformers.	100/98 <sup>1)</sup> x 45 x 120
PMD s20	Monitors the insulation resistance of unearthed AC/DC systems (IT systems)	100/98 <sup>1)</sup> x 45 x 120

# relays PMDsigma

## Applications PMD s20

The PMD s20 can be used to monitor the insulation resistance of unearthed AC/DC systems. Thanks to the separate supply voltage, monitoring of the de-energized system is possible. Typical application areas include:

- ▶ Clinical operating theaters
- ▶ Offshore installations such as wind turbines, clarification plants and shiplifts
- ▶ Electroplating and surface finishing systems

### Your benefits at a glance

- ▶ For universal use: only one unit to stock
- ▶ Quick and easy settings, just turn and click, so set-up and commissioning times are short
- ▶ Error-proof: menu-based configuration
- ▶ Ideal when exchanging units: configuration is stored on the chip card
- ▶ Simple diagnostics via the display mean minimum downtimes
- ▶ Approved for applications worldwide



Features	Order number
<ul style="list-style-type: none"> <li>▶ Measuring range is set automatically for current and voltage</li> <li>▶ Function parameter settings are menu-driven</li> <li>▶ Analogue outputs for current and voltage. Voltage output 0 ... 10 V. Current output convertible from 0 ... 20 mA to 4 ... 20 mA.</li> <li>▶ Relay outputs for monitoring underload and overload</li> <li>▶ Supply voltage (<math>U_B</math>): 24 ... 240 VAC/DC</li> <li>▶ Output contacts: 2 auxiliary contacts (C/O)</li> <li>▶ Measuring voltage (3 AC), <math>U_M</math> (AC/DC): 100 ... 550 V</li> <li>▶ Measuring current (<math>I_M</math>): 1 ... 12 A AC/DC</li> </ul>	<ul style="list-style-type: none"> <li>▶ Spring-loaded terminals PMD s10 C _____ 761 100</li> <li>▶ Plug-in screw terminals PMD s10 _____ 760 100</li> </ul>
<ul style="list-style-type: none"> <li>▶ Response value <math>R_{on}</math>: selectable from 10 ... 200 k<math>\Omega</math></li> <li>▶ Voltage:                             <ul style="list-style-type: none"> <li>- Voltage supply via universal power supply: 24 ... 240 VAC/DC</li> <li>- Measuring voltage of the IT system to be monitored: 0 ... 400 VAC/DC</li> </ul> </li> <li>▶ Frequency range AC: 50 ... 60 Hz</li> <li>▶ Start-up suppression/reaction time: selectable from 0 ... 30 s</li> <li>▶ Hysteresis: selectable from 0 ... 50 %</li> </ul>	<ul style="list-style-type: none"> <li>▶ Spring-loaded terminals PMD s20 C _____ 761 120</li> <li>▶ Plug-in screw terminals PMD s20 _____ 760 120</li> </ul>



Keep up-to-date on PMDsigma:

Webcode 5215

Online information at [www.pilz.com](http://www.pilz.com)

<sup>1)</sup> Height with spring-loaded terminals / plug-in screw terminals

## ▶ Electronic monitoring relays PMDsrage



S3UM

S1IM

S1WP

### Reliably taking control of every situation

Reliable electronic monitoring and control of plant and machinery is at the heart of our range of monitoring relays. PMDsrage units in 22.5 mm slimline housing cover the widest range of functions.

### Selection guide – Electronic monitoring relays PMDsrage



#### Type

#### Technical features

#### S3UM

Monitors AC voltages for overvoltage and undervoltage, phase sequence/failure and asymmetry, three-phase

- ▶ Monitors supplies with and without neutral conductors
- ▶ Trip device for undervoltage and overvoltage
- ▶ Evaluates phase sequence
- ▶ Detects asymmetry and phase failure



#### S1PN

Monitors phase sequence and phase failure on three-phase supplies

- ▶ Measuring voltage up to 690 VAC
- ▶ Monitors phase sequence, phase failure, fuse



#### S1IM

Monitors AC/DC currents for max. current values, single-phase

- ▶ 12 measuring ranges can be selected from 0.002 to 15 A
- ▶ Reaction time can be set to up to 10 seconds
- ▶ Operates to either normally energized or normally de-energized mode
- ▶ Galvanic isolation between measuring and supply voltage
- ▶ UP version: measuring inputs are not polarity-sensitive



#### S1EN

Monitors insulation and earth faults on galvanically isolated AC/DC supplies, single and three-phase

- ▶ For DC and AC supplies
- ▶ Normally energized mode
- ▶ Fault latching or automatic reset
- ▶ Normal/test mode
- ▶ External reset button can be connected



#### S1WP

Monitors and converts true power, DC supplies and single-/three-phase AC supplies, relay and analog output, monitors overload and underload

- ▶ Nine different measuring ranges
- ▶ Large voltage measurement range
- ▶ Analogue output can be switched for current and voltage
- ▶ Relay output for monitoring underload and overload
- ▶ Suitable for use with frequency-controlled motors
- ▶ Suitable for current transformers



#### S1MS

Monitors the temperature of PTC temperature sensors to protect the motor from overheating

- ▶ For DC and AC supplies
- ▶ Normally energized mode
- ▶ Automatic reset

In addition to current, voltage and insulation monitors, the range also includes relays for true power, phase sequence and temperature monitoring. Quick and easy installation, practical terminals, a variety of operator elements as well as luminous displays all help to make commissioning easier and ensure the units are perfectly tailored to the specific application.



**Your benefits at a glance**

- ▶ Parameters can be set on the front, meaning short commissioning times
- ▶ Save space in the control cabinet: Widths of just 22.5 mm
- ▶ Rapid diagnostics via LED status display

	Order number <sup>1)</sup>
<ul style="list-style-type: none"> <li>▶ Supply voltage (U<sub>B</sub>): AC: 120 V; DC: 24 V</li> <li>▶ Output contacts: 1 auxiliary contact (C/O)</li> <li>▶ Measuring voltage (3 AC) (U<sub>M</sub>): AC: 42, 230, 100/110, 400/440, 440/480, 415/460, 500/550 V, selectable</li> <li>▶ Dimensions (H x W x D): 87 x 22.5 x 122 mm</li> </ul>	<ul style="list-style-type: none"> <li>▶ 24 VDC (U<sub>B</sub>), 230 VAC (U<sub>M</sub>) _____ 837 260</li> <li>▶ 24 VDC (U<sub>B</sub>), 400/440 VAC (U<sub>M</sub>) _____ 837 270</li> <li>▶ 24 VDC (U<sub>B</sub>), 415/460 VAC (U<sub>M</sub>) _____ 837 280</li> </ul>
<ul style="list-style-type: none"> <li>▶ Supply voltage (U<sub>B</sub>): AC: 200 ... 240, 400 ... 500, 550 ... 690 V</li> <li>▶ Output contacts: 2 auxiliary contacts (2 C/O)</li> <li>▶ Dimensions (H x W x D): 87 x 22.5 x 121 mm</li> </ul>	<ul style="list-style-type: none"> <li>▶ 200 ... 240 V _____ 890 200</li> <li>▶ 400 ... 500 V _____ 890 210</li> <li>▶ 550 ... 690 V _____ 890 220</li> </ul>
<ul style="list-style-type: none"> <li>▶ Supply voltage (U<sub>B</sub>): AC: 24, 42 ... 48, 110 ... 127, 230 ... 240 V; DC: 24 V</li> <li>▶ Output contacts: 1 auxiliary contact (C/O)</li> <li>▶ Dimensions (H x W x D): 87 x 22.5 x 121 mm</li> </ul>	<ul style="list-style-type: none"> <li>▶ 110 ... 130 VAC (U<sub>B</sub>), 15 A (I<sub>M</sub>) _____ 828 040</li> <li>▶ 230 ... 240 VAC (U<sub>B</sub>), 15 A (I<sub>M</sub>) _____ 828 050</li> <li>▶ 24 VDC (U<sub>B</sub>), 15 A (I<sub>M</sub>) _____ 828 035</li> </ul>
<ul style="list-style-type: none"> <li>▶ Supply voltage (U<sub>B</sub>): AC/DC: 24 ... 240 V</li> <li>▶ Output contacts: 1 auxiliary contact (C/O)</li> <li>▶ Rated mains voltage (monitored supply):                             <ul style="list-style-type: none"> <li>- 50 kΩ version: AC/DC: 0 ... 240 V</li> <li>- 200 kΩ version: AC/DC: 0 ... 400 V</li> </ul> </li> <li>▶ Dimensions (H x W x D): 87 x 22.5 x 121 mm</li> </ul>	<ul style="list-style-type: none"> <li>▶ 24 ... 240 VAC/DC (U<sub>B</sub>), 50 kΩ _____ 884 100</li> <li>▶ 24 ... 240 VAC/DC (U<sub>B</sub>), 200 kΩ _____ 884 110</li> </ul>
<ul style="list-style-type: none"> <li>▶ Supply voltage (U<sub>B</sub>): DC: 24 V, AC/DC: 230 V</li> <li>▶ Output contacts: 1 auxiliary contact (C/O)</li> <li>▶ Measuring voltage: 3 AC/1 AC/DC:                             <ul style="list-style-type: none"> <li>0 ... 70, 0 ... 120, 0 ... 140, 0 ... 240, 0 ... 320, 0 ... 415, 0 ... 550 V</li> </ul> </li> <li>▶ Dimensions (H x W x D): 87 x 22.5 x 121 mm</li> </ul>	<ul style="list-style-type: none"> <li>▶ 9 A (I<sub>M</sub>), 24 VDC (U<sub>B</sub>), 0 ... 240 VAC/DC _____ 890 010</li> <li>▶ 9 A (I<sub>M</sub>), 24 VDC (U<sub>B</sub>), 0 ... 415 VAC/DC _____ 890 020</li> <li>▶ 9 A (I<sub>M</sub>), 24 VDC (U<sub>B</sub>), 0 ... 550 VAC/DC _____ 890 030</li> </ul>
<ul style="list-style-type: none"> <li>▶ Supply voltage (U<sub>B</sub>): AC: 48, 110, 230, 240, 400 V; AC/DC: 24 V</li> <li>▶ Output contacts: 2 auxiliary contacts (2 C/O)</li> <li>▶ Dimensions (H x W x D): 87 x 22.5 x 121 mm</li> </ul>	<ul style="list-style-type: none"> <li>▶ 24 VAC/DC (U<sub>B</sub>) _____ 840 775</li> <li>▶ 230 VAC (U<sub>B</sub>) _____ 840 760</li> <li>▶ 400 VAC (U<sub>B</sub>) _____ 840 770</li> </ul>



Keep up-to-date on PMDsrage:

Webcode 5219

Online information at [www.pilz.com](http://www.pilz.com)

<sup>1)</sup> Additional versions on request

Order number features: U<sub>B</sub> = Supply voltage; U<sub>M</sub> = Measuring voltage; I<sub>M</sub> = Measuring current

## ► Safety relay PNOZ®

In 1987 Pilz patented the world's first emergency stop relay to protect man and machine. That was a milestone in safety technology. Today, PNOZ safety relays are proven daily in millions of applications worldwide. In addition to the classic E-STOP function, our safety relays also monitor safety gates, light beam devices, two-hand controls, safety mats and many other safety functions.

We can offer the optimum safety solution for each application. Our safety relays are distinguished by a variety of supply voltage ranges, the number of safety contacts, the number of terminals or the ability to plug in terminals. Unit types in push-in technology offer a great advantage in terms of both economy and safety.

They help you to reduce costs through short commissioning and service times. Based on their different features and functionalities, our products can be divided into the following product ranges:

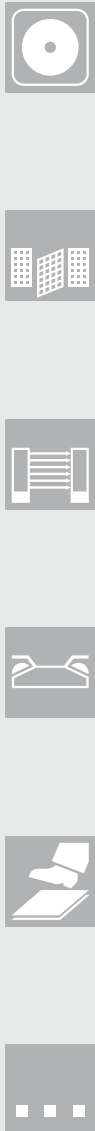

**PNOZsigma**

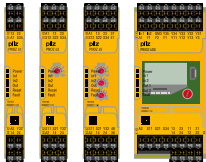
**PNOZ X**

**PNOZcompact**

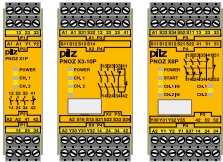

**PNOZelog**

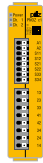
**PNOZpower**

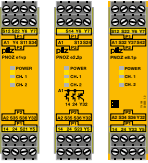
### Safety relay

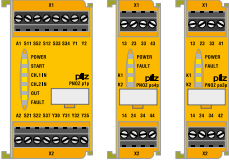
#### PNOZsigma

- ▶ Maximum functionality in minimum width
- ▶ Operating modes and times are selectable
- ▶ Scalability thanks to modular structure

#### PNOZ X

- ▶ Tailor-made safety for each function
- ▶ Electromechanical, volt-free
- ▶ With universal power supply

#### PNOZcompact

- ▶ Square, simple, yellow
- ▶ Ideal for high volume manufacturers of series machines
- ▶ Basic function of a safety application

#### PNOZelog

- ▶ Easy to link
- ▶ Non-wearing
- ▶ Expanded diagnostics

#### PNOZpower

- ▶ High loads from 8 A to 16 A
- ▶ Switch motor loads directly
- ▶ Modular output contacts

### Finding your PNOZ

This diagram will help you to choose. You have specific requirements, we have the right solution.



More than three safety functions/  
configurable?

Yes

No

Breaking capacity > 8 A?

Yes

No

Good scalability/  
user-friendly diagnostics?

Yes

No

Plug-in terminals/  
universal power supply?

Yes

No

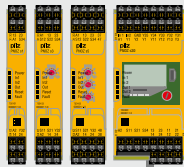

**PNOZsigma**  
Further information from page 18

No

Ability to connect safety functions via AND/OR logic

Yes

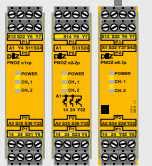

**PNOZelog**  
Further information from page 40

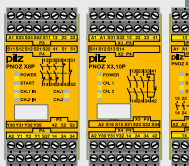

**PNOZ X**  
Further information from page 30



**PNOZcompact**  
Further information from page 38

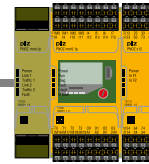

**PNOZmulti Mini**  
Further information from page 68

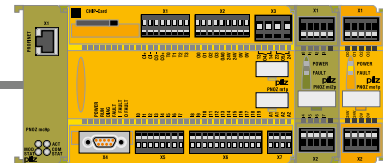

**PNOZmulti**  
Further information from page 74

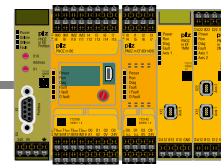

**PNOZmulti 2**  
Further information from page 60



**PNOZmulti Configurator**  
Further information from page 58

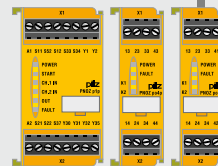

**PNOZpower**  
Further information from page 50

## ► Protection of man and machine

It pays to use safety technology - The protection of man and machine through the targeted control of hazardous movements, cost savings thanks to fewer accidents, reduced downtimes and fewer production losses - these are real benefits that you can enjoy when you use safe control technology from Pilz.

### Safety relays PNOZ – Certified worldwide

When using the safety relays PNOZ, the aim is to keep the risk to man and machine as low as possible. Internationally co-ordinated statutory instruments were introduced to ensure that the same level of protection could be guaranteed in all countries.

Our safety relays comply with these international standards and regulations. The safety relay PNOZ has been approved by BG, TÜV and many other notified bodies and offers users considerable benefits. Long service life and high availability ensure it is cost-effective to use.

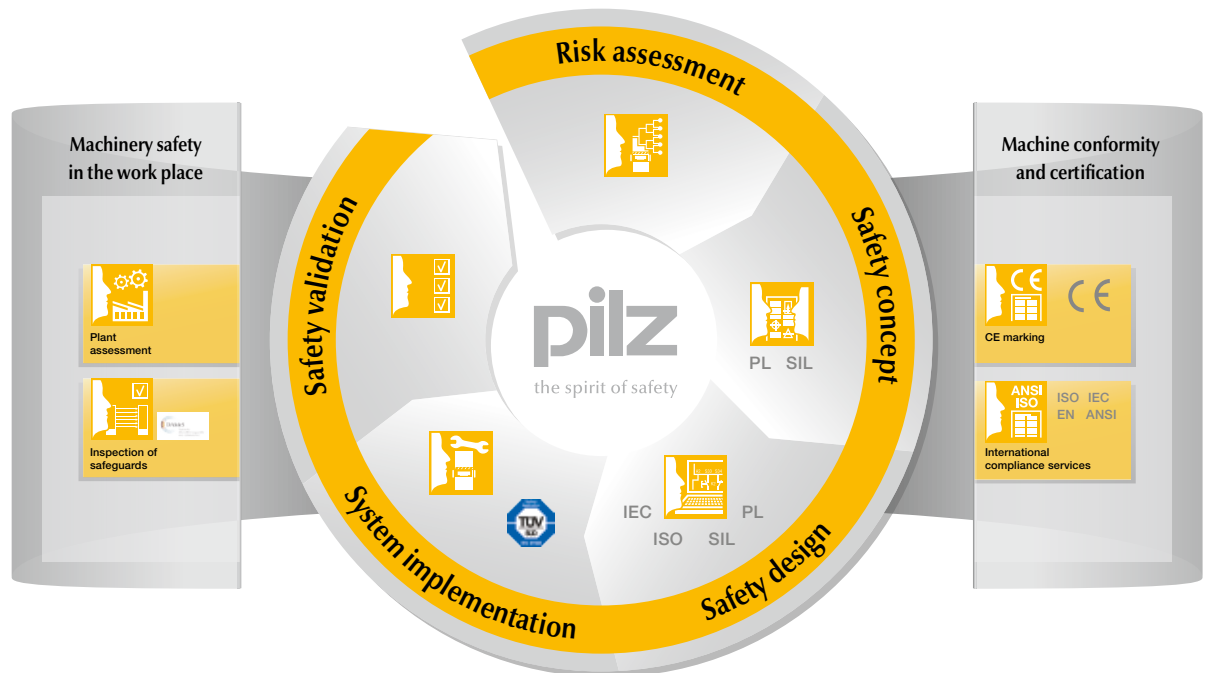



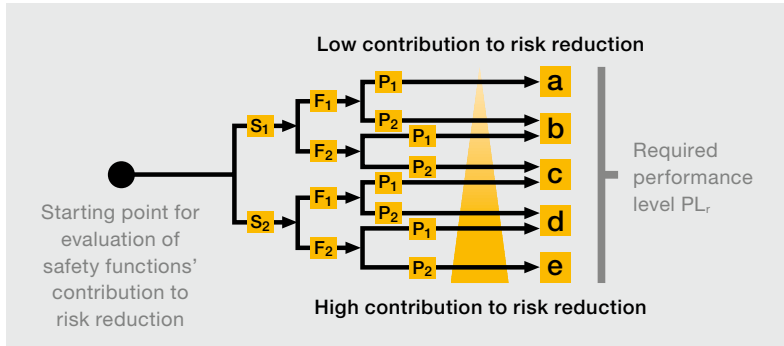

Risk analysis in accordance with EN ISO 13849-1

**EN ISO 13849-1**

As the successor standard to EN 954-1, EN ISO 13849-1 is based on the familiar categories. Equally, it examines complete safety functions, including all the components involved in their design. EN ISO 13849-1 goes beyond the qualitative approach of EN 954-1 to include a quantitative assessment of the safety functions. A performance level (PL) is used for this, building upon the categories.

Consequences	Se	Class CL = Fr + Pr + Av				
		3-4	5-7	8-10	11-13	14-15
Death, losing an eye or arm	4	SIL 2	SIL 2	SIL 2	SIL 3	SIL 3
Permanent, losing fingers	3		OM	SIL 1	SIL 2	SIL 3
Reversible, medical attention	2			OM	SIL 1	SIL 2
Reversible, first aid	1				OM	SIL 1

Risk assessment and definition of the required safety integrity level (SIL)

**Safety assessment in accordance with EN/IEC 62061**

According to the standard EN/IEC 62061, safety requirements in control technology can be divided into safety integrity levels. SIL 3 represents the highest risk reduction and protection level, where the safety function must always be maintained. The risk is estimated through consideration of the severity of injury (Se), the frequency and duration of exposure to the hazard (Fr), probability of occurrence of a hazardous event (Pr) and the possibility of avoiding or limiting the harm (Av).

**Your benefits at a glance**

The use of safety relays PNOZ offers you:

- ▶ The security and innovative strength of one of the leading brands in automation technology
- ▶ The appropriate solution for each application
- ▶ High plant availability thanks to user-friendly diagnostics
- ▶ Low downtimes for your plant or machinery
- ▶ Optimum cost/performance ratio
- ▶ Faster commissioning, for example, through units with plug-in terminals
- ▶ Maximum safety with minimum space requirement
- ▶ Simple wiring, fast commissioning
- ▶ A solid partner with expertise
- ▶ Certified safety, because our products comply with international standards and regulations and have been tested and approved worldwide
- ▶ Quality guarantee, we are certified to DIN ISO 9001
- ▶ Use of products that are geared towards the future, thanks to innovative developments
- ▶ Complete solution comprising evaluation devices, compatible sensor technology and control and signal devices

Find out more about the standards:

 Webcode 0240

Online information at [www.pilz.com](http://www.pilz.com)

## ► Safety relays PNOZsigma

The compact safety relays PNOZsigma combine many years of experience with today's very latest safety technology: you can achieve maximum safety and cost-effectiveness with minimum effort. With particularly narrow housing widths and multifunctionality compressed into each unit, PNOZsigma provides maximum functionality in minimum width. So you can implement safety technology faster, with greater flexibility and therefore more efficiently, while saving space.



PNOZ s1    PNOZ s3    PNOZ s5    PNOZ s30

### Fewer types – suitable for a variety of uses

- Selectable operating modes and timers enable each unit to be flexible in its application
- A single unit type monitors different safety functions
- Your stockholding can be reduced to a few unit types

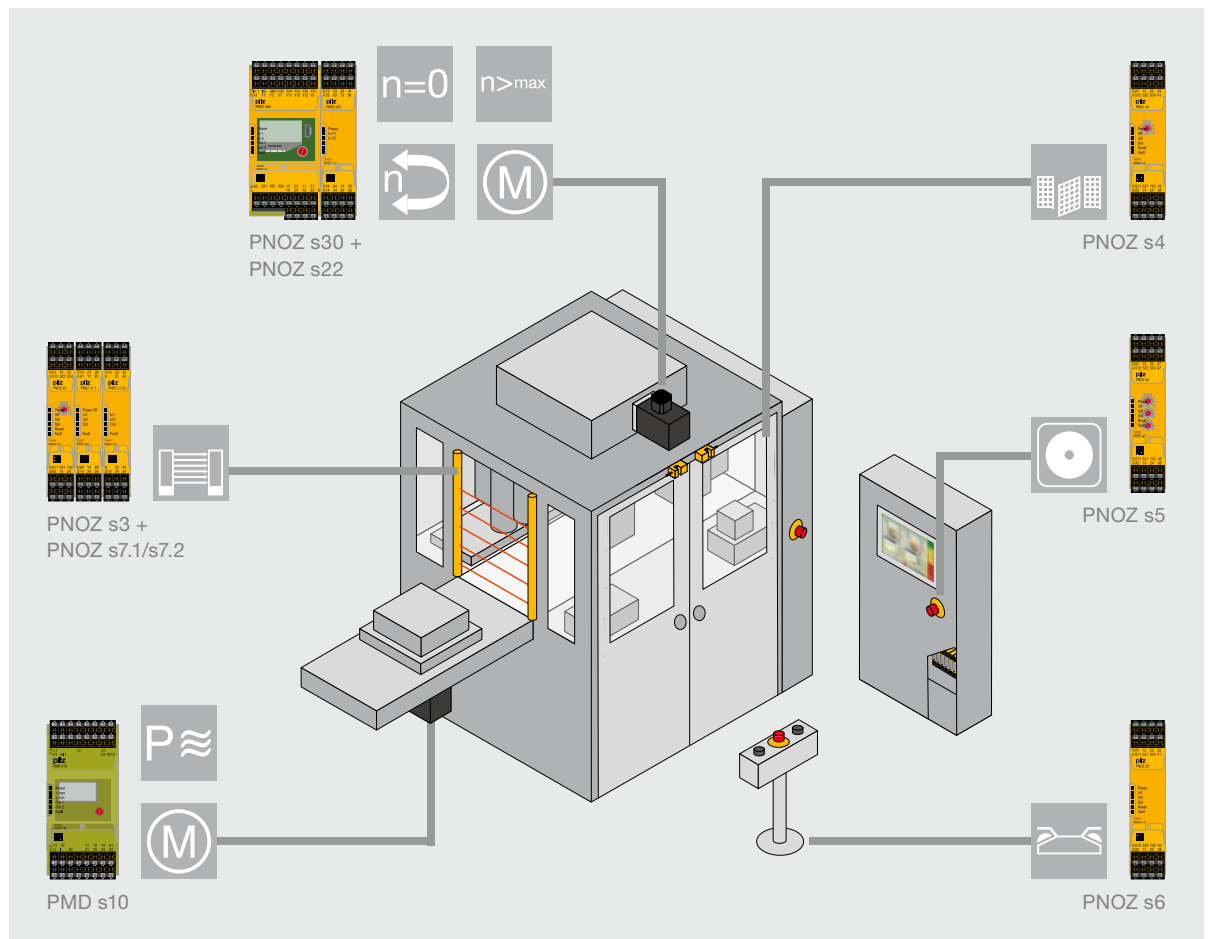

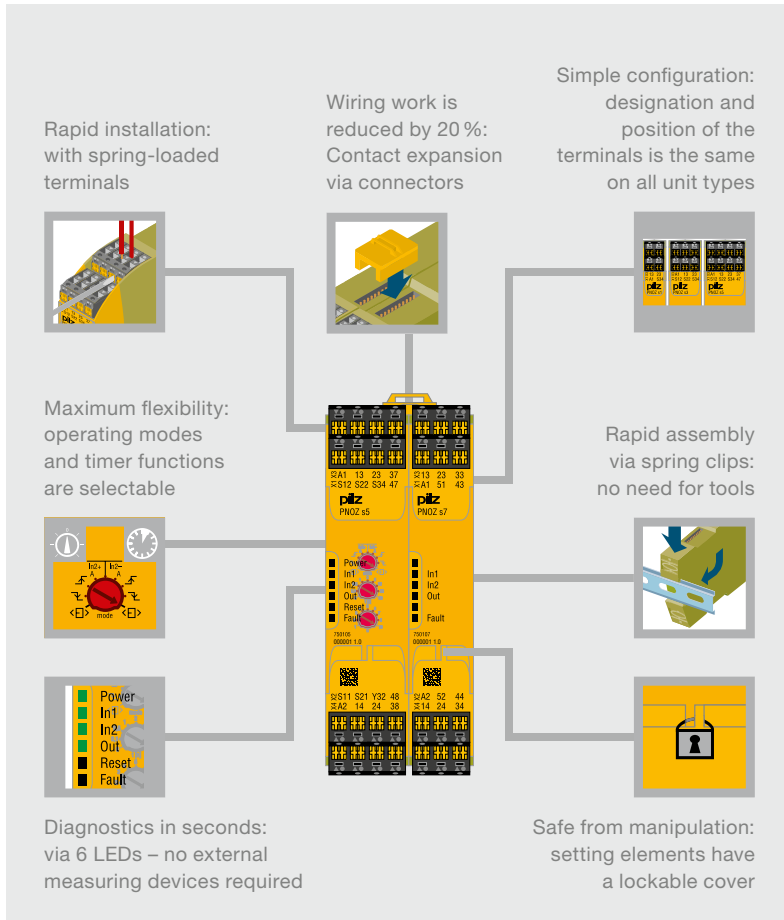

- Your benefits at a glance**
- ▶ Narrower widths save space within the control cabinet, and therefore costs!
  - ▶ Reduce wiring costs through push-in technology and expand the number of contacts via connectors
  - ▶ Rapid commissioning and high availability
  - ▶ Low logistics costs: few unit types to stock, covering many safety functions
  - ▶ Use the complete solution from Pilz and supplement the PNOZsigma with compatible, approved safety components: from E-STOP pushbuttons to safe sensors such as safety switches and light curtains, through to operator terminals for diagnostics and visualization

**Up to 50 % space saving**

- ▶ Widths from 12.5 mm
- ▶ Housing is up to 50 % narrower with the same functionality<sup>1)</sup>
- ▶ Reduced space requirement in the control cabinet saves costs

<sup>1)</sup> Compared with standard electromechanical safety relays on the market

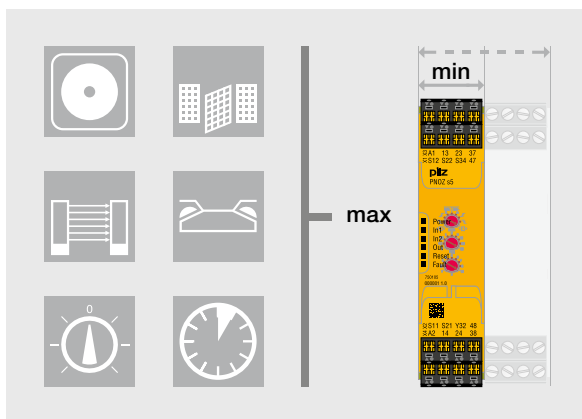

Keep up-to-date on safety relays PNOZsigma:

Webcode 5229

Online information at [www.pilz.com](http://www.pilz.com)

## ► Convenient speed monitoring

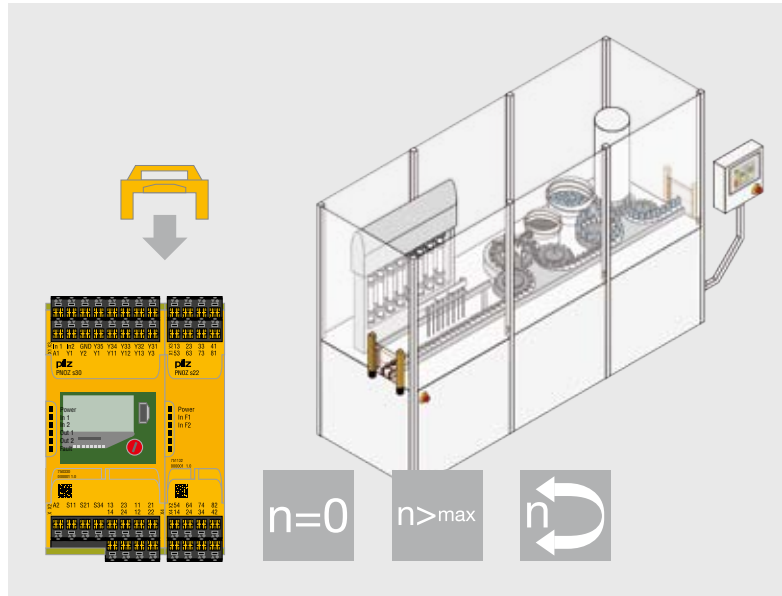

Relay contacts can be multiplied by combining PNOZ s22 and PNOZ s30.

### Safe speed monitor PNOZ s30

Convenient speed monitoring – the speed monitor PNOZ s30 provides safe monitoring of standstill, speed, direction of rotation and shear pin breakage. For example, travelling at reduced speed during set-up mode increases operator safety. Productivity is increased, as an unnecessary shutdown is prevented. This all saves costs and protects machinery as well as staff. It also enables you to comply with the requirement of the new Machinery Directive, which states that in the field of drive monitoring, the operating status must be safely monitored and maintained when the drive is brought to a standstill. Typical applications are amusement parks, balancing machines, high bay racking, centrifuges, filling machines, machining centers and wind turbines.

### Your benefits at a glance

- Increased productivity and safety for operating personnel
- Productivity is increased by avoiding unnecessary shutdown processes: advance warning is given when a defined warning threshold is reached
- Save time during setup and when units are exchanged, thanks to convenient operation via rotary knob (push and turn)
- Suitable for all common motor feedback systems and proximity switches
- Contact expansion module PNOZ s22: Duplication of the relay contacts enables the application's function range to be expanded

### Contact expansion module PNOZ s22 – Twice as good

PNOZ s22 provides two relay functions that can be controlled separately in accordance with PL e of EN ISO 13849-1. Each relay function provides 3 N/O/1 N/C contacts. These can be controlled separately, so that the outputs can be assigned different functions, depending on the base unit. Safe separation between the two relay functions enables different potentials to be switched.

Keep up-to-date on safety relays PNOZsigma:



Webcode 5229

Online information at [www.pilz.com](http://www.pilz.com)



## ► PNOZsigma types

### Safety relay PNOZ s4 with approval in accordance with EN 81-1/A3

The "Lifts standard" EN 81-1 defines the safety rules for the "construction and installation of lifts; Part 1: Electric lifts". The PNOZ s4 has this approval and guarantees lift operators and lift manufacturers maximum functionality in minimum width. At a width of 22.5 mm, PNOZ s4 achieves PL e of EN ISO 13849-1 and SIL CL claim 3. The application area of PNOZ s4 extends from passenger lifts and goods/service lifts through to all types of lifting machinery, which are subject to this standard.

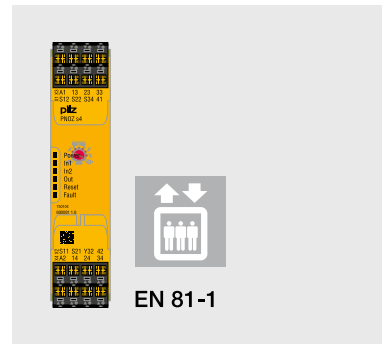

### Safe firing with PNOZ s4.1

Thanks to three safe, diverse safety contacts, the PNOZ s4.1 is approved for use in burner controls. It is approved in accordance with the standard EN 50156-1 for electrical equipment on furnaces, in particular with regard to the requirements for application design and installation.



### Multiple expansion with PNOZ s7.1 and PNOZ s7.2

With a base unit and a PNOZ s7.1, the number of safety contacts can be expanded almost without limit. Up to ten PNOZ s7.2 can be connected to a PNOZ s7.1. If you need more contacts, an additional PNOZ s7.1 can be added to the series. No wiring is involved – just a connector and one simple hand movement.

At just 17.5 mm wide, the PNOZ s7.1 has three safety contacts, while the PNOZ s7.2 has four safety contacts plus one auxiliary contact. They can be combined with other PNOZsigma expansion units at any time.

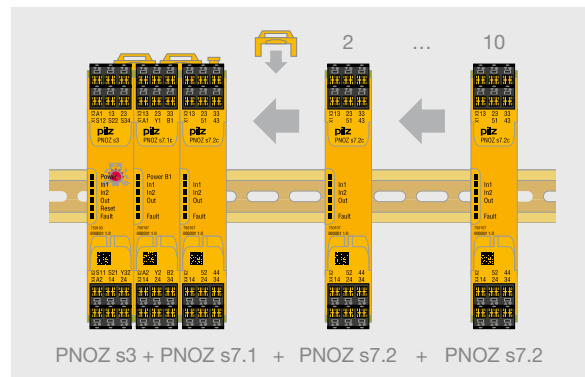

Rapid contact expansion – it's easy with PNOZsigma!

## ▶ Safety relay PNOZ s50 for safe brake control

The stand-alone safety relay PNOZ s50 offers an economical solution for controlling two brakes up to category PL e of EN ISO 13849-1. The contactless technology allows very short reaction times to be achieved, enhancing personal protection. You can take advantage of the full flexibility and the individual shutdown options for your application of this manufacturer-independent solution.



PNOZ s50

### Safe, contactless braking – so it's non-wearing

PNOZ s50 helps to make your plant energy efficient: Application cycle times are shortened because temporary overexcitation is followed by selectable voltage reduction (pulse width modulation PWM). The safety relay enables rapid switching in emergency situations and slow, low-wearing switching in normal operation, thereby helping to reduce maintenance costs.

As an addition to the PNOZsigma product range, PNOZ s50 has a rotary knob for menu navigation and a display for showing setup parameters and diagnostic messages.

Both motor brakes and safety brakes can be safely controlled and monitored with the safety relay PNOZ s50. Safety is significantly improved due to “wear monitoring”, particularly on motor-integrated holding brakes (but not holding brakes).



Find out more in the animation on the safety relay PNOZ s50

### Safety relay PNOZ s50



PNOZ s50

#### Technical features

- ▶ Stand-alone device
- ▶ 2 brakes up to PL e of EN ISO 13849-1 / SIL CL 3 of EN/IEC 62061
- ▶ 1 brake up to PL d of EN ISO 13849-1 / SIL CL 3 of EN/IEC 62061
- ▶ 2 x 2-pole safe electronic digital outputs for 24 VDC, each 4.5 A
- ▶ Temporary overexcitation with subsequent voltage reduction
- ▶ Ambient temperature: 0 ... 45 °C
- ▶ Number of inputs:
  - Failsafe: 4
  - Standard: 4
- ▶ Number of failsafe semiconductor outputs:
  - 1-pole: 3
  - 2-pole: 2

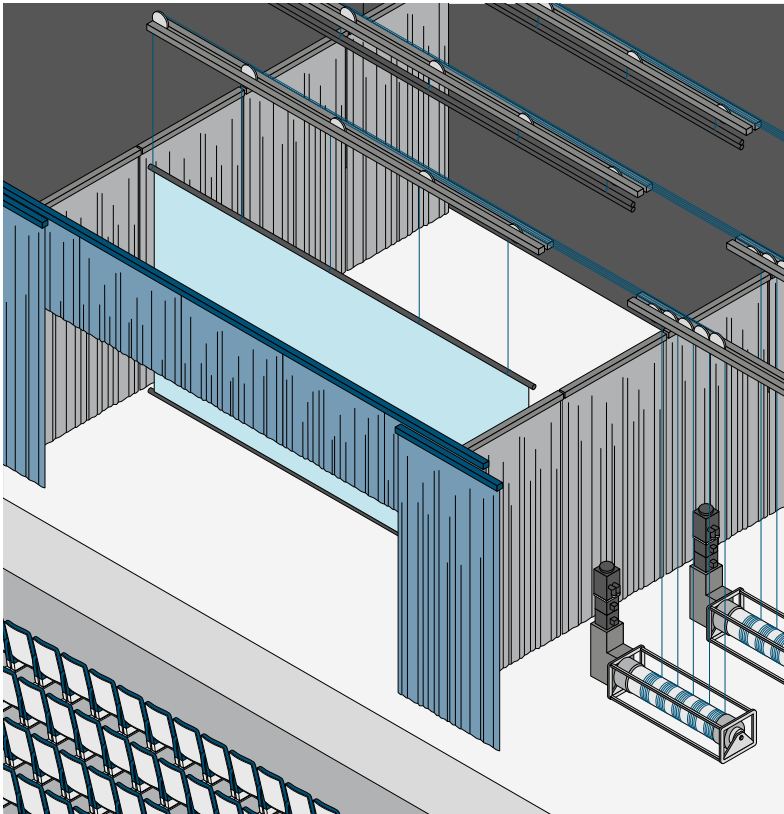

**Your benefits at a glance**

- ▶ Highest level of safety up to PL e when controlling 2 brakes (holding brakes or safety brakes)
- ▶ Contactless technology up to 4.5 A per brake enables short reaction times, a long-lasting solution and high availability
- ▶ Reduced cycle times through temporary overexcitation with subsequent voltage reduction
- ▶ High safety and low wear on the brake thanks to fast and slow shutdown of the power circuits
- ▶ Rapid diagnostics by means of display
- ▶ Manufacturer-independent brake control thanks to safe, digital inputs

In many applications it is necessary to safeguard an additional brake alongside the holding brake. In the field of stage technology, for example, winches are operated with a dual brake.

- ▶ Supply voltage:
  - 1-pole: 24 VDC
  - 2-pole: 24 VDC, 48 VDC
- ▶ Voltage tolerance:
  - 1-pole: -15 % ... +20 %
  - 2-pole: -10 % ... +10 %
- ▶ Output current of semiconductor outputs (1-pole): 0.1 A
- ▶ Test pulse outputs – semiconductor outputs (1-pole): 2

- ▶ Reduced voltage of semiconductor outputs (2-pole): 6 V, 8 V, 12 V, 16 V, 24 V
- ▶ Output current of semiconductor outputs (2-pole):
  - 24 VDC supply voltage:
    - Continuous duty (1 output/2 outputs): 1 x 6.5 A/2 x 4.5 A
    - Overexcitation (1 output/2 outputs): 1 x 6.5 A/  $\Sigma = 10$
  - 48 VDC supply voltage:
    - Continuous duty (1 output/2 outputs): 1 x 3.25 A/2 x 2.25 A
    - Overexcitation (1 output/2 outputs): 1 x 3.25 A/2 x 3.25 A

**Order number**

751 500  
(with spring-loaded terminals)

Technical documentation on safety relays PNOZ s50:

 Webcode 5229

Online information at [www.pilz.com](http://www.pilz.com)

## ▶ Selection guide – PNOZsigma

### Safety relays PNOZsigma

Type	Application	Performance Level (PL) – EN ISO 13849-1
		
PNOZ s1	◆ ◆	c
PNOZ s2	◆ ◆	e
PNOZ s3	◆ ◆ ◆	e
PNOZ s4	◆ ◆ ◆	e
PNOZ s4.1	◆ ◆ ◆	e
PNOZ s5	◆ ◆ ◆ ◆	e
PNOZ s6	◆ EN 574, Type IIIC	e
PNOZ s6.1	◆ EN 574, Type IIIA	c
PNOZ s7	Contact expansion	e
PNOZ s7.1	Contact expansion	e
PNOZ s7.2	Contact expansion	e
PNOZ s8	Contact expansion	c
PNOZ s9	Contact expansion or safe timer relay ◆	e
PNOZ s10	Contact expansion	e
PNOZ s11	Contact expansion	e
PNOZ s22	Contact expansion for PNOZ s30 and PNOZ mm0.1p/mm0.2p	e

Type	Application	Performance Level (PL) – EN ISO 13849-1
		
PNOZ s30	Safe speed and standstill monitor ◆ ◆ ◆	e

Type	Application	Performance Level (PL) – EN ISO 13849-1
		
PNOZ s50 <sup>1)</sup>	Safe brake control ◆	e





Safety Integrity Level (SIL) CL – claim limit in accordance with IEC 62061	Output contacts				Universal power supply 48 ... 240 VAC/DC	Housing width in mm
	Safe		Auxiliary contacts			
2	2	-	-	1		12.5
3	3	-	1	1		17.5
3	2	-	-	1		17.5
3	3	-	1	1	◆	22.5
3	3	-	1	1	◆	22.5
3	2	2	-	1	◆	22.5
3	3	-	1	1	◆	22.5
1	3	-	1	1	◆	22.5
3	4	-	1	-		17.5
3	3	-	-	-		17.5
3	4	-	1	-		17.5
2	2	-	-	1		12.5
3	-	3	1	-		17.5
3	4	-	1	-		45.0
3	8	-	1	-		45.0
3	2 x 3	-	2 x 1	-		22.5

Safety Integrity Level (SIL) CL – claim limit in accordance with IEC 62061	Output contacts				Universal power supply 24 ... 240 VAC/DC	Housing width in mm
	Safe		Auxiliary contacts			
3	2	-	2	4	◆	45.0

Safety Integrity Level (SIL) CL – claim limit in accordance with IEC 62061	Semiconductor outputs		Universal power supply 24 ... 240 VAC/DC	Housing width in mm
	2-pole	1-pole		
3	2	3		45.0

Technical  
documentation  
on safety relays  
PNOZsigma:

Webcode 0685

Online information  
at [www.pilz.com](http://www.pilz.com)

<sup>1)</sup> For technical details see page 22

## ► Technical details – PNOZsigma



### Safety relays PNOZsigma



PNOZ s1



PNOZ s3



PNOZ s5



PNOZ s6

Type	Supply voltage (U <sub>B</sub> ):	Outputs: Voltage/current/rating	Dimensions (H x W x D) in mm
<b>PNOZ s1</b>	24 VDC	DC1: 24 V/3 A/72 W	100/98 <sup>1)</sup> x 12.5 x 120
<b>PNOZ s2</b>	24 VDC	DC1: 24 V/6 A/150 W	100/98 <sup>1)</sup> x 17.5 x 120
<b>PNOZ s3</b>	24 VDC	DC1: 24 V/6 A/150 W	100/98 <sup>1)</sup> x 17.5 x 120
<b>PNOZ s4</b>	<ul style="list-style-type: none"> <li>▶ 24 VDC</li> <li>▶ 24 ... 240 VAC/DC</li> </ul>	DC1: 24 V/6 A/150 W	100/98 <sup>1)</sup> x 22.5 x 120
<b>PNOZ s4.1</b>	<ul style="list-style-type: none"> <li>▶ 24 VDC</li> <li>▶ 48 ... 240 VAC/DC</li> </ul>	DC1: 24 V/6 A/150 W	100/98 <sup>1)</sup> x 22.5 x 120
<b>PNOZ s5</b>	<ul style="list-style-type: none"> <li>▶ 24 VDC</li> <li>▶ 48 ... 240 VAC/DC</li> </ul>	DC1: 24 V/6 A/150 W	100/98 <sup>1)</sup> x 22.5 x 120
<b>PNOZ s6</b>	<ul style="list-style-type: none"> <li>▶ 24 VDC</li> <li>▶ 48 ... 240 VAC/DC</li> </ul>	DC1: 24 V/6 A/150 W	100/98 <sup>1)</sup> x 22.5 x 120
<b>PNOZ s6.1</b>	<ul style="list-style-type: none"> <li>▶ 24 VDC</li> <li>▶ 48 ... 240 VAC/DC</li> </ul>	DC1: 24 V/6 A/150 W	100/98 <sup>1)</sup> x 22.5 x 120

Features	Order number	
	Spring-loaded terminals	Plug-in screw terminals
<ul style="list-style-type: none"> <li>▶ Single-channel wiring</li> <li>▶ Manual/automatic reset</li> </ul>	751 101	750 101
<ul style="list-style-type: none"> <li>▶ Single-channel wiring</li> <li>▶ Monitored reset</li> <li>▶ Manual/automatic reset</li> <li>▶ Safe separation</li> </ul>	751 102	750 102
<ul style="list-style-type: none"> <li>▶ Single- and dual-channel wiring</li> <li>▶ Detection of shorts across contacts</li> <li>▶ Monitored reset</li> <li>▶ Manual/automatic reset</li> <li>▶ Start-up testing</li> </ul>	751 103	750 103
<ul style="list-style-type: none"> <li>▶ Single- and dual-channel wiring</li> <li>▶ Detection of shorts across contacts</li> <li>▶ Monitored reset</li> <li>▶ Manual/automatic reset</li> <li>▶ Start-up testing</li> <li>▶ Approval to EN 81-1/A3 in accordance with the Lifts Directive</li> </ul>	<ul style="list-style-type: none"> <li>▶ 24 VDC _____ 751 104</li> <li>▶ 24 VDC, coated version ____ 751 184</li> <li>▶ 24 ... 240 VAC/DC _____ 751 134</li> </ul>	<ul style="list-style-type: none"> <li>▶ 24 VDC _____ 750 104</li> <li>▶ 24 ... 240 VAC/DC _____ 750 134</li> </ul>
<ul style="list-style-type: none"> <li>▶ Single- and dual-channel wiring</li> <li>▶ Detection of shorts across contacts</li> <li>▶ Monitored reset</li> <li>▶ Manual/automatic reset</li> <li>▶ Start-up testing</li> <li>▶ 3 safe, diverse safety contacts</li> <li>▶ Approved in accordance with EN 50156-1 for electrical equipment for furnaces</li> </ul>	<ul style="list-style-type: none"> <li>▶ 24 VDC _____ 751 124</li> <li>▶ 48 ... 240 VAC/DC _____ 751 154</li> </ul>	<ul style="list-style-type: none"> <li>▶ 24 VDC _____ 750 124</li> <li>▶ 48 ... 240 VAC/DC _____ 750 154</li> </ul>
<ul style="list-style-type: none"> <li>▶ Single- and dual-channel wiring</li> <li>▶ Detection of shorts across contacts</li> <li>▶ Monitored reset</li> <li>▶ Manual/automatic reset</li> <li>▶ Start-up testing</li> <li>▶ Timer functions: delay-on de-energization</li> <li>▶ Time range: 0 ... 300 s</li> </ul>	<ul style="list-style-type: none"> <li>▶ 24 VDC _____ 751 105</li> <li>▶ 24 VDC, coated version ____ 751 185</li> <li>▶ 48 ... 240 VAC/DC _____ 751 135</li> </ul>	<ul style="list-style-type: none"> <li>▶ 24 VDC _____ 750 105</li> <li>▶ 48 ... 240 VAC/DC _____ 750 135</li> </ul>
<ul style="list-style-type: none"> <li>▶ Dual-channel wiring</li> <li>▶ Detection of shorts across contacts</li> </ul>	<ul style="list-style-type: none"> <li>▶ 24 VDC _____ 751 106</li> <li>▶ 48 ... 240 VAC/DC _____ 751 136</li> </ul>	<ul style="list-style-type: none"> <li>▶ 24 VDC _____ 750 106</li> <li>▶ 48 ... 240 VAC/DC _____ 750 136</li> </ul>
<ul style="list-style-type: none"> <li>▶ Dual-channel wiring</li> <li>▶ Detection of shorts across contacts</li> </ul>	<ul style="list-style-type: none"> <li>▶ 24 VDC _____ 751 126</li> <li>▶ 48 ... 240 VAC/DC _____ 751 156</li> </ul>	<ul style="list-style-type: none"> <li>▶ 24 VDC _____ 750 126</li> <li>▶ 48 ... 240 VAC/DC _____ 750 156</li> </ul>

<sup>1)</sup> Height with spring-loaded terminals / plug-in screw terminals



Technical documentation on safety relays PNOZsigma:

Webcode 0685

Online information at [www.pilz.com](http://www.pilz.com)

## ► Technical details – PNOZsigma



### Safety relays PNOZsigma



PNOZ s7



PNOZ s7.1



PNOZ s8



PNOZ s10



PNOZ s11



PNOZ s22



PNOZ s30

Type	Supply voltage (U <sub>B</sub> ):	Outputs: Voltage/current/rating	Dimensions (H x W x D) in mm
PNOZ s7	24 VDC	DC1: 24 V/6 A/150 W	100/98 <sup>1)</sup> x 17.5 x 120
PNOZ s7.1	24 VDC	DC1: 24 V/6 A/150 W	100/98 <sup>1)</sup> x 17.5 x 120
PNOZ s7.2	24 VDC	DC1: 24 V/6 A/150 W	100/98 <sup>1)</sup> x 17.5 x 120
PNOZ s8	24 VDC	DC1: 24 V/3 A/72 W	100/98 <sup>1)</sup> x 12.5 x 120
PNOZ s9	24 VDC	DC1: 24 V/6 A/150 W	100/98 <sup>1)</sup> x 17.5 x 120
PNOZ s10	24 VDC	DC1: 24 V/12 A/300 W	100/98 <sup>1)</sup> x 45.0 x 120
PNOZ s11	24 VDC	DC1: 24 V/6 A/150 W	100/98 <sup>1)</sup> x 45.0 x 120
PNOZ s22	24 VDC	DC1: 24 V/6 A/150 W	100/98 <sup>1)</sup> x 22.5 x 120
PNOZ s30	24 ... 240 VAC/DC	DC1: 24 V/4 A/100 W	100/98 <sup>1)</sup> x 45.0 x 120

Features	Order number	
	Spring-loaded terminals	Plug-in screw terminals
<ul style="list-style-type: none"> <li>▶ Safe separation</li> </ul>	<ul style="list-style-type: none"> <li>▶ 24 VDC _____ 751 107</li> <li>▶ 24 VDC, coated version ____ 751 187</li> </ul>	750 107
<ul style="list-style-type: none"> <li>▶ Cascading module for connection to PNOZ s7.2</li> <li>▶ Safe separation of safety contacts</li> <li>▶ LEDs for input and switch status</li> <li>▶ Can also be used with other safety control devices, without a PNOZsigma base unit: one input circuit affects the output relays</li> </ul>	751 167	750 167
<ul style="list-style-type: none"> <li>▶ Contact expansion module in conjunction with PNOZ s7.1</li> </ul>	751 177	750 177
-	751 108	750 108
<ul style="list-style-type: none"> <li>▶ Safe separation</li> <li>▶ Timer functions: delay-on energization, delay-on de-energization, pulsing, retriggerable</li> <li>▶ Time range: 0 ... 300 s</li> </ul>	<ul style="list-style-type: none"> <li>▶ 24 VDC _____ 751 109</li> <li>▶ 24 VDC, coated version ____ 751 189</li> </ul>	750 109
<ul style="list-style-type: none"> <li>▶ Safe separation</li> </ul>	751 110	750 110
<ul style="list-style-type: none"> <li>▶ Safe separation</li> </ul>	751 111	750 111
<ul style="list-style-type: none"> <li>▶ Two safety contacts that can be controlled separately</li> <li>▶ Contact expansion for the speed monitor PNOZ s30 and the base units PNOZ mm0.1p/mm0.2p of the configurable safety relays PNOZmulti Mini</li> </ul>	751 132	750 132
<ul style="list-style-type: none"> <li>▶ Safe monitoring of standstill, speed, direction of rotation and shear pin breakage</li> <li>▶ Parameters for device functions can be freely set</li> <li>▶ Parameters are entered via rotary knob (push and turn) in conjunction with a monochrome display</li> <li>▶ Set parameters are saved on a chip card</li> <li>▶ Integrated display shows the set limit values/ parameters as well as the current speed</li> <li>▶ Tolerances can be freely set for each limit value</li> <li>▶ Axis position monitoring is available as an option with the standstill function</li> <li>▶ Advance warning of shutdown when a certain threshold is reached</li> </ul>	751 330	750 330

<sup>1)</sup> Height with spring-loaded terminals / plug-in screw terminals



Technical documentation on safety relays PNOZsigma:

Webcode 0685

Online information at [www.pilz.com](http://www.pilz.com)

## ▶ Safety relays PNOZ X

Safety relays from the product range PNOZ X are proven through their reliability and robustness and have developed a wide application range in the most varied of safety applications. PNOZ is the world's most widely used safety relay. One PNOZ is used per safety function.



PNOZ X1P



PNOZ X3P



PNOZ X9P

### Customized safety for each application

Its technical features are based on voltage-free, electromechanical contacts in 2 relay technology. Sizes vary from 22.5 to 90 mm, the number of contacts from two to eight. Whatever your safety requirement – PNOZ X has already proved itself a million times over in the rugged everyday industrial environment. Why not take advantage!

### Your benefits at a glance

- ▶ Technology proven over many years of use
- ▶ Huge selection of products
- ▶ For all safety functions such as monitoring E-STOPS, safety gates, light beam devices, muting, pressure sensitive mats, two-hand control and much more
- ▶ Delayed and instantaneous contact expansion modules, safe timers, safe monitoring relays for standstill, speed and other functions
- ▶ Excellent price/performance ratio
- ▶ Rapid commissioning thanks to plug-in terminals
- ▶ Maximum safety with minimum space requirement
- ▶ Complete solution comprising evaluation devices, compatible sensor technology, control and signal devices
- ▶ Low storage costs thanks to universal power supply and plug-in terminals



Keep up-to-date on safety relays PNOZ X:

 Webcode 5225



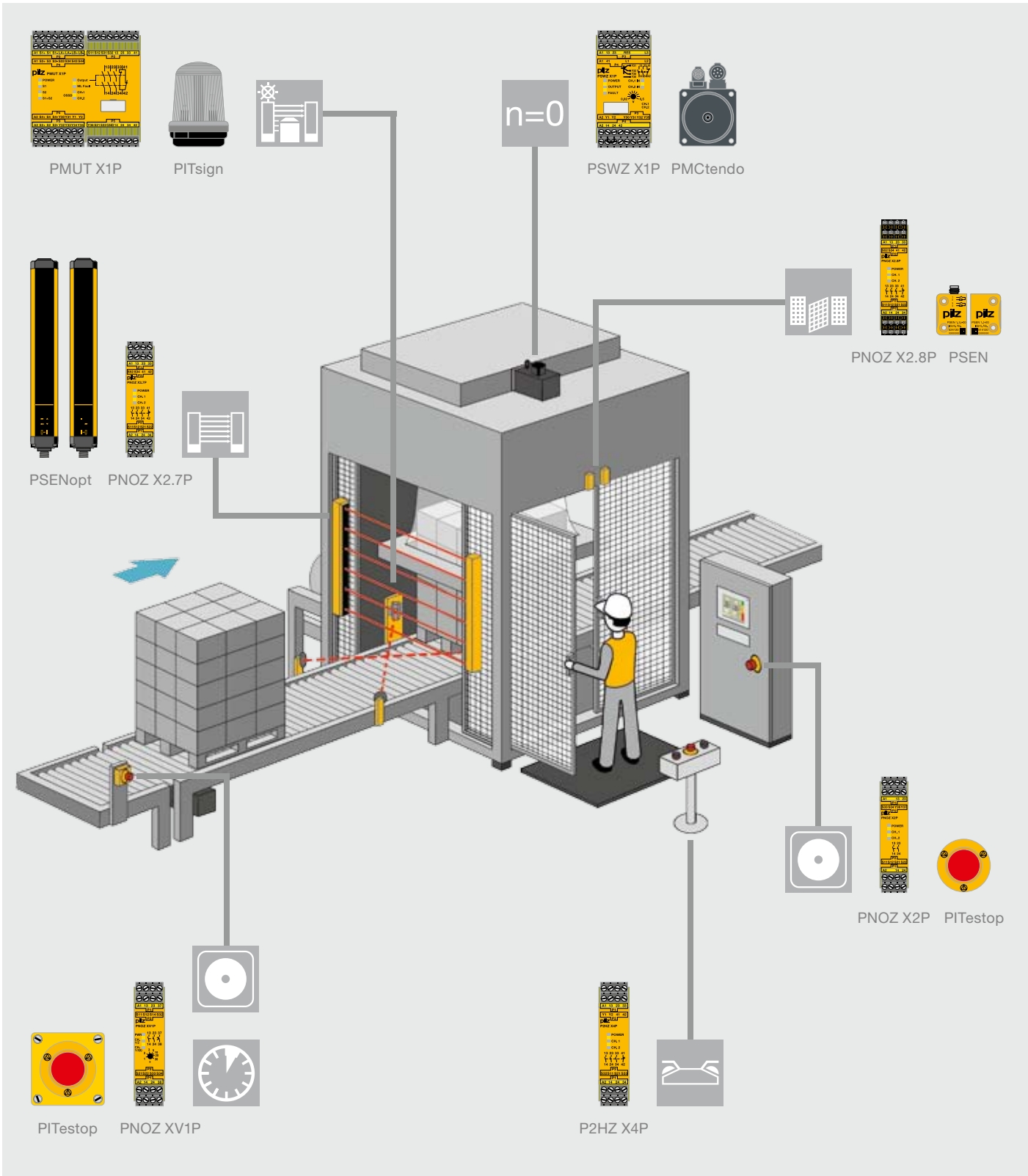



Online information at [www.pilz.com](http://www.pilz.com)







Example: using safety relays PNOZ X on a packaging machine.

## ► Selection guide – PNOZ X

### Safety relays PNOZ X

Type	Application					
						
PNOZ X1P	◆	◆				
PNOZ X2P	◆	◆				
PNOZ X2.7P	◆	◆	◆			
PNOZ X2.8P	◆	◆	◆			
PNOZ X3P	◆	◆	◆			
PNOZ X7P	◆	◆				
PNOZ X8P	◆	◆	◆			
PNOZ X9P	◆	◆	◆			
PNOZ X10.11P	◆	◆	◆			
PNOZ X11P	◆	◆	◆			
PNOZ XV1P	◆	◆	◆			
PNOZ XV3P	◆	◆	◆			
PNOZ XV3.1P	◆	◆	◆			
PMUT X1P	◆		◆	◆		
P2HZ X1P					◆	EN 574, Type IIIC
P2HZ X4P					◆	EN 574, Type IIIC
PSWZ X1P						◆
PZE X4P	Contact expansion					



Performance Level (PL) – EN ISO 13849-1	Safety Integrity Level (SIL) CL – claim limit in accordance with IEC 62061	Output contacts				Housing width in mm
		Safety-related		Non-safety-related		
						
e	3	3	-	1	-	22.5
e	3	2	-	-	-	22.5
e	3	3	-	1	-	22.5
e	3	3	-	1	-	22.5
e	3	3	-	1	1	45.0
e	3	2	-	-	-	22.5
e	3	3	-	2	2	45.0
e	3	7	-	2	2	90.0
e	3	6	-	4	-	90.0
e	3	7	-	1	2	90.0
e (d) <sup>1)</sup>	3	2	1	-	-	22.5
e (d) <sup>1)</sup>	3	3	2	-	-	45.0
e (d) <sup>1)</sup>	3	3	2	1	-	90.0
e	3	3	-	1	5	90.0
e	3	3	-	1	2	45.0
e	3	3	-	1	-	22.5
e	3	2	-	1	1	45.0
e	3	4	-	-	-	22.5

<sup>1)</sup> Value applies for instantaneous (delayed) safety contacts

Technical documentation on safety relays PNOZ X:

 Webcode 0685

Online information at [www.pilz.com](http://www.pilz.com)

## ► Technical details – PNOZ X

### Safety relays PNOZ X



PNOZ X1P



PNOZ X2.8P



PNOZ X3P



PNOZ X9P

Type	Supply voltage (U <sub>B</sub> ):	Outputs: Voltage/current/rating	Dimensions (H x W x D) in mm
<b>PNOZ X1P</b>	24 VDC	DC1: 24 V/6 A/150 W	101/94 <sup>1)</sup> x 22.5 x 121
<b>PNOZ X2P</b>	<ul style="list-style-type: none"> <li>▶ 24 VAC/DC</li> <li>▶ 48 ... 240 VAC/DC</li> </ul>	DC1: 24 V/6 A/150 W	101/94 <sup>1)</sup> x 22.5 x 121
<b>PNOZ X2.7P</b> <b>PNOZ X2.8P</b>	<ul style="list-style-type: none"> <li>▶ 24 VAC/DC</li> <li>▶ 24 ... 240 VAC/DC</li> </ul>	DC1: 24 V/6 A/150 W	101/94 <sup>1)</sup> x 22.5 x 121
<b>PNOZ X3P</b>	<ul style="list-style-type: none"> <li>▶ 24 VAC/DC</li> <li>▶ 24 ... 240 VAC/DC</li> </ul>	DC1: 24 V/8 A/200 W	101/94 <sup>1)</sup> x 45 x 121
<b>PNOZ X7P</b>	<ul style="list-style-type: none"> <li>▶ 24 VAC/DC</li> <li>▶ 110 ... 120, 230 ... 240 VAC</li> </ul>	DC1: 24 V/6 A/150 W	101/94 <sup>1)</sup> x 22.5 x 121
<b>PNOZ X8P</b>	<ul style="list-style-type: none"> <li>▶ 24 VDC</li> <li>▶ 24, 110, 230 VAC</li> </ul>	DC1: 24 V/8 A/200 W	101/94 <sup>1)</sup> x 45 x 121
<b>PNOZ X9P</b>	<ul style="list-style-type: none"> <li>▶ 12 VDC</li> <li>▶ 24 VDC, 100 ... 240 VAC</li> </ul>	DC1: 24 V/8 A/200 W	101/94 <sup>1)</sup> x 90 x 121
<b>PNOZ X11P</b>	<ul style="list-style-type: none"> <li>▶ 24 VDC, 24 VAC</li> <li>▶ 110 ... 120, 230 ... 240 VAC</li> </ul>	DC1: 24 V/8 A/200 W	101/94 <sup>1)</sup> x 90 x 121

Features	Order number	
	Spring-loaded terminals	Plug-in screw terminals
▶ 1-channel operation	787 100	777 100
▶ 2-channel operation with detection of shorts across contacts ▶ Automatic or monitored reset can be selected	▶ 24 VAC/DC _____ 787 303 ▶ 48 ... 240 VAC/DC _____ 787 307	▶ 24 VAC/DC _____ 777 303 ▶ 48 ... 240 VAC/DC _____ 777 307
▶ 2-channel operation with or without detection of shorts across contacts ▶ PNOZ X2.7P: Monitored start ▶ PNOZ X2.8P: Automatic start	▶ PNOZ X2.7P C - 24 VAC/DC _____ 787 305 - 24 ... 240 VAC/DC _____ 787 306 ▶ PNOZ X2.8P C - 24 VAC/DC _____ 787 301 - 24 ... 240 VAC/DC _____ 787 302	▶ PNOZ X2.7P C - 24 VAC/DC _____ 777 305 - 24 ... 240 VAC/DC _____ 777 306 ▶ PNOZ X2.8P C - 24 VAC/DC _____ 777 301 - 24 ... 240 VAC/DC _____ 777 302
▶ Dual-channel wiring, with or without detection of shorts across contacts ▶ Monitored or automatic reset can be selected ▶ 1 semiconductor output ▶ Safety gate function with N/C / N/O combination	▶ 24 VAC/DC _____ 787 310 ▶ 24 ... 240 VAC/DC _____ 787 313	▶ 24 VAC/DC _____ 777 310 ▶ 24 ... 240 VAC/DC _____ 777 313
▶ 1-channel operation	▶ 24 VAC/DC _____ 787 059 ▶ More available on request	▶ 24 VAC/DC _____ 777 059 ▶ More available on request
▶ 2-channel operation with or without detection of shorts across contacts ▶ Monitored or automatic reset can be selected ▶ 2 semiconductor outputs	▶ 24 VAC _____ 787 770 ▶ 24 VDC _____ 787 760 ▶ More available on request	▶ 24 VAC _____ 777 770 ▶ 24 VDC _____ 777 760 ▶ More available on request
▶ Dual-channel wiring, with or without detection of shorts across contacts ▶ Monitored or automatic reset can be selected ▶ 2 semiconductor outputs	▶ 24 VDC _____ 787 609 ▶ 24 VDC, 100 ... 240 VAC _____ 787 606	▶ 12 VDC _____ 777 607 ▶ 24 VDC _____ 777 609 ▶ 24 VDC, 100 ... 240 VAC _____ 777 606
▶ Dual-channel wiring, with or without detection of shorts across contacts ▶ Monitored or automatic reset can be selected ▶ 2 semiconductor outputs	▶ 24 VDC, 24 VAC _____ 787 080 ▶ 110 ... 120 VAC _____ 787 083 ▶ 230 ... 240 VAC _____ 787 086	▶ 24 VDC, 24 VAC _____ 777 080 ▶ 110 ... 120 VAC, 24 VDC _____ 777 083 ▶ 230 ... 240 VAC, 24 VDC _____ 777 086

<sup>1)</sup> Height with spring-loaded terminals / plug-in screw terminals



Relays

Technical documentation on safety relays PNOZ X:

Webcode 0685

Online information at [www.pilz.com](http://www.pilz.com)

## ► Technical details – PNOZ X

### Safety relays PNOZ X



PNOZ XV1P



PNOZ XV3P



PMUT X1P



P2HZ X4P

Type	Supply voltage (U <sub>B</sub> ):	Outputs: Voltage/current/rating	Dimensions (H x W x D) in mm
<b>PNOZ XV1P</b>	24 VDC	DC1: 24 V/5 A/125 W	101/94 <sup>1)</sup> x 22.5 x 121
<b>PNOZ XV3P</b>	24 VDC	DC1: 24 V/8 A/200 W	101/94 <sup>1)</sup> x 45 x 121
<b>PNOZ XV3.1P</b>	<ul style="list-style-type: none"> <li>▶ 24 VDC</li> <li>▶ 24 ... 240 VAC/DC</li> </ul>	DC1: 24 V/8 A/200 W	101/94 <sup>1)</sup> x 90 x 121
<b>PMUT X1P</b>	24 VDC	DC1: 24 V/8 A/200 W	101/94 <sup>1)</sup> x 90 x 121
<b>P2HZ X1P</b>	<ul style="list-style-type: none"> <li>▶ 24 VDC</li> <li>▶ 24, 42, 110, 115, 230, 240 VAC</li> </ul>	DC1: 24 V/5 A/125 W	101/94 <sup>1)</sup> x 45 x 121
<b>P2HZ X4P</b>	24 VAC/DC	DC1: 24 V/5 A/125 W	101/94 <sup>1)</sup> x 22.5 x 121
<b>PSWZ X1P</b>	24 ... 240 VAC/DC	DC1: 24 V/6 A/150 W	101/94 <sup>1)</sup> x 45 x 121
<b>PZE X4P</b>	24 VDC	DC1: 24 V/6 A/150 W	101/94 <sup>1)</sup> x 22.5 x 121

Features	Order number	
	Spring-loaded terminals	Plug-in screw terminals
<ul style="list-style-type: none"> <li>▶ Dual-channel wiring, with or without detection of shorts across contacts</li> <li>▶ Monitored or automatic reset can be selected</li> </ul>	<ul style="list-style-type: none"> <li>▶ 0.1 ... 3 s _____ 787 601</li> <li>▶ 1 ... 30 s _____ 787 602</li> </ul>	<ul style="list-style-type: none"> <li>▶ 0.1 ... 3 s _____ 777 601</li> <li>▶ 1 ... 30 s _____ 777 602</li> </ul>
<ul style="list-style-type: none"> <li>▶ Dual-channel wiring, with or without detection of shorts across contacts</li> <li>▶ Monitored or automatic reset can be selected</li> </ul>	<ul style="list-style-type: none"> <li>▶ 3 s _____ 787 512</li> <li>▶ 30 s _____ 787 510</li> <li>▶ More available on request</li> </ul>	<ul style="list-style-type: none"> <li>▶ 3 s _____ 777 512</li> <li>▶ 30 s _____ 777 510</li> <li>▶ More available on request</li> </ul>
<ul style="list-style-type: none"> <li>▶ Dual-channel wiring, with or without detection of shorts across contacts</li> <li>▶ Monitored or automatic reset can be selected</li> <li>▶ Universal power supply 24 ... 240 VAC/DC</li> </ul>	<ul style="list-style-type: none"> <li>▶ 3 s selectable, 24 ... 240 VAC/DC _____ 787 532</li> <li>▶ 30 s selectable, 24 ... 240 VAC/DC _____ 787 530</li> <li>▶ More available on request</li> </ul>	<ul style="list-style-type: none"> <li>▶ 3 s selectable, 24 ... 240 VAC/DC _____ 777 532</li> <li>▶ 30 s selectable, 24 ... 240 VAC/DC _____ 777 530</li> <li>▶ More available on request</li> </ul>
<ul style="list-style-type: none"> <li>▶ Up to 4 muting sensors</li> <li>▶ Monitoring and switching muting lamps</li> <li>▶ Parallel and sequential muting</li> <li>▶ Simultaneity monitoring</li> <li>▶ 5 semiconductor outputs</li> <li>▶ Reset input</li> <li>▶ Override function via key switch in the case of a fault</li> <li>▶ LED status indicators</li> </ul>	788 010	778 010
<ul style="list-style-type: none"> <li>▶ 2 semiconductor outputs</li> </ul>	<ul style="list-style-type: none"> <li>▶ 24 VDC _____ 787 340</li> <li>▶ More available on request</li> </ul>	<ul style="list-style-type: none"> <li>▶ 24 VDC _____ 777 340</li> <li>▶ More available on request</li> </ul>
<ul style="list-style-type: none"> <li>▶ 22.5 mm width</li> </ul>	<ul style="list-style-type: none"> <li>▶ 24 VAC _____ 787 354</li> <li>▶ 24 VDC _____ 787 355</li> </ul>	<ul style="list-style-type: none"> <li>▶ 24 VAC _____ 777 354</li> <li>▶ 24 VDC _____ 777 355</li> </ul>
<ul style="list-style-type: none"> <li>▶ Safe standstill monitoring</li> <li>▶ 1 or 2-channel operation</li> <li>▶ No external components required</li> <li>▶ Fault signal if simultaneity time is exceeded</li> <li>▶ Reset input</li> <li>▶ Detects open circuits</li> </ul>	<ul style="list-style-type: none"> <li>▶ U<sub>M</sub>: 0.5 V _____ 787 949</li> <li>▶ U<sub>M</sub>: 3 V _____ 787 950</li> </ul>	<ul style="list-style-type: none"> <li>▶ U<sub>M</sub>: 0.5 V _____ 777 949</li> <li>▶ U<sub>M</sub>: 3 V _____ 777 950</li> </ul>
<ul style="list-style-type: none"> <li>▶ 1-channel operation</li> </ul>	787 585	777 585

<sup>1)</sup> Height with spring-loaded terminals / plug-in screw terminals



Relays

Technical documentation on safety relays PNOZ X:

Webcode 0685

Online information at [www.pilz.com](http://www.pilz.com)

## ▶ Safety relay PNOZcompact

The safety relay is optimized for functionality and can be used in all areas of engineering. In series machine production in particular, the use of the PNOZcompact has many advantages thanks to its concentrated functionality: So high-volume projects with a high degree of standardization can be implemented economically. Opt for a safety relay PNOZ – the original, the synonym for safety relays.

**GIT  
SECURITY  
AWARD  
2015  
FINALIST**

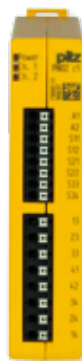

PNOZ c1

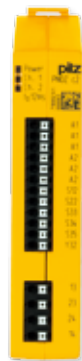

PNOZ c2

### Square, simple, yellow

Do you wish to safely monitor an emergency stop device, safety gate or light beam device? Is it important to you to save time through simple installation and maintenance? Then we have the right solution for you – the safety relay PNOZcompact.

PNOZ c1 is ideal for monitoring emergency stops or safety gates. A block diagram with connection example is printed on the side of the unit and is a great help. PNOZ c2 is ideally suited for safe monitoring of Type 4 light beam devices, e.g. PSENopt from Pilz or sensors with OSSD outputs in accordance with EN 61496-1, with a maximum reaction time of 12 ms. You save time through simple installation because the transmitter and receiver are supplied with voltage directly via the evaluation device.

### Safety relay PNOZcompact

#### Common features

- ▶ PL e of EN ISO 13849-1, Safety Integrity Level (SIL) CL claim limit 3 in accordance with IEC 62061
- ▶ Supply voltage (U<sub>B</sub>): 24 VDC
- ▶ LEDs to display operating voltage and switch status
- ▶ Spring-loaded terminals fixed on the device

Type	Application area	Dimensions (H x W x D) in mm
PNOZ c1	E-STOP relay and safety gate monitor	105 <sup>1)</sup> x 22.5 x 100
PNOZ c2	For monitoring Type 4 light beam devices or sensors with OSSD outputs in accordance with EN 61496-1	105 <sup>1)</sup> x 22.5 x 100

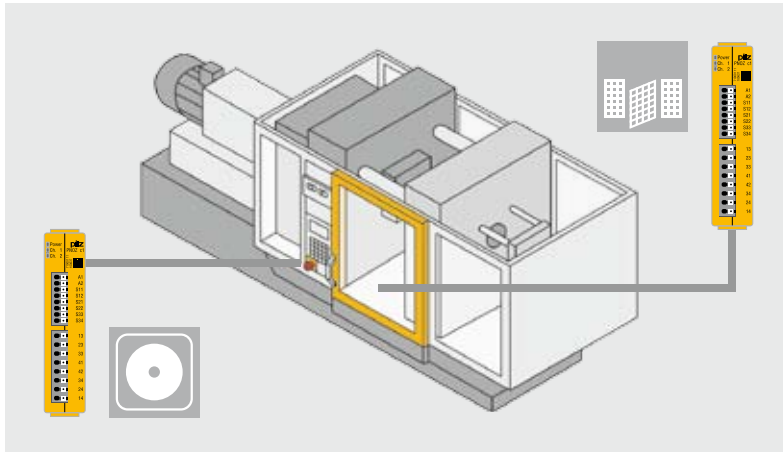

**Your benefits at a glance**

- ▶ Save space in the control cabinet thanks to the compact design
- ▶ Save time through simple installation and maintenance: push-in spring terminals fixed on the device, connected without the need for tools
- ▶ Tool-free assembly: simply attach the device to the top hat rail

Monitor an E-STOP or safety gate – in any industry – in any application – safe, simple, compact. Use one safety relay per safety function.

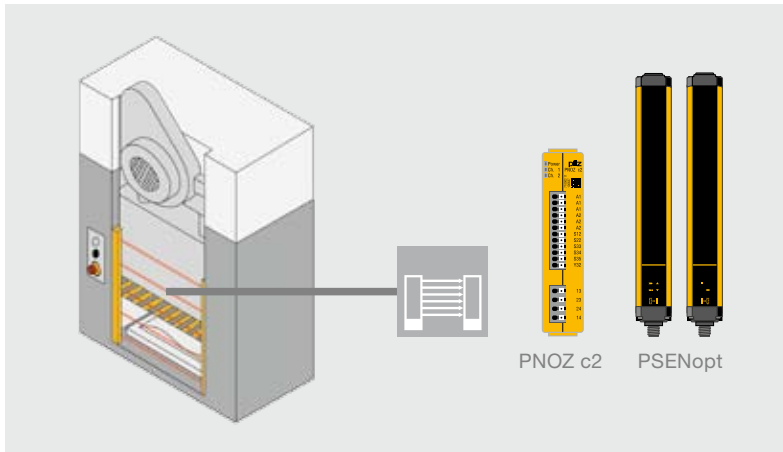

Monitor light beam devices such as PSENopt from Pilz or sensors with OSSD outputs in safe, simple and compact form. All common light beam devices can also be connected.

Keep up-to-date on safety relays PNOZcompact:



Webcode 8180

Online information at [www.pilz.com](http://www.pilz.com)

Features	Order number
<ul style="list-style-type: none"> <li>▶ 3 safety contacts/1 auxiliary contact (3 N/O/1 N/C)</li> <li>▶ Dual-channel wiring with detection of shorts across contacts, manual or automatic reset</li> <li>▶ Stop category: 0</li> </ul>	710001
<ul style="list-style-type: none"> <li>▶ 2 safety contacts (N/O)/1 semiconductor output</li> <li>▶ Dual-channel wiring without detection of shorts across contacts, monitored or automatic start</li> </ul>	710002

<sup>1)</sup> Height incl. spring clip



## ► Safety relays PNOZelog

Ideal for monitoring up to four safety functions, the innovative PNOZelog product range combines the experience of the electromechanical safety relays with the benefits of modern electronics.



PNOZ e1.1p



PNOZ e6.1p

### Extended diagnostics, easy to link

Wear-resistance, safety, long service life and high availability ensure it is cost-effective to use. What's more, the PNOZelog can be linked through logic AND/OR operations. Diagnostics on the PNOZelog have been extended. Power-up tests, self-checking and runtime tests guarantee maximum safety.

### Complete safety functions through logic function operations

Units in the PNOZelog product range can be linked via logic operations to form complete safety functions. AND/OR operations are both available. The use of logic functions means that the output requires no additional wiring. Both outputs on the PNOZelog units are freely available. As many units as necessary can be connected in series – ideal for monitoring up to four safety functions.

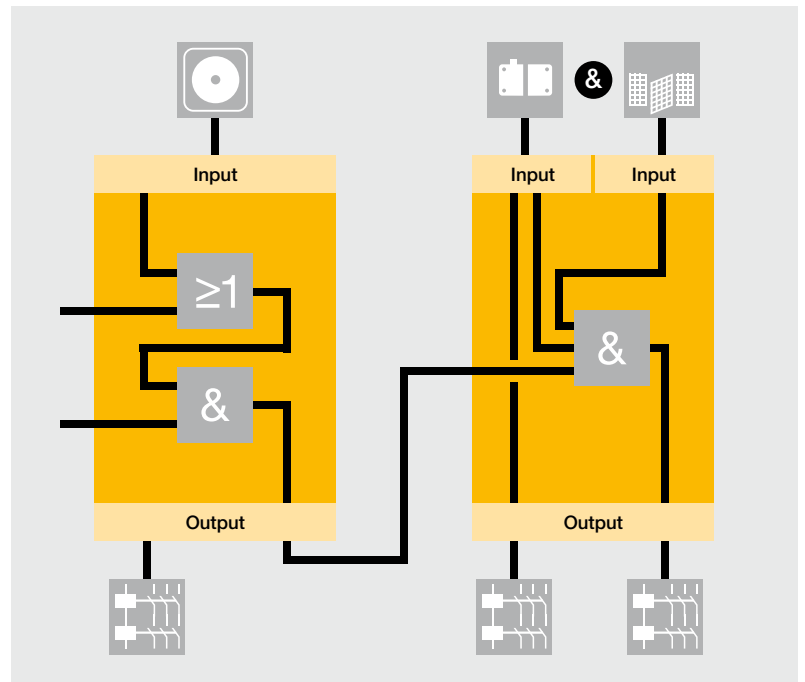

Less wiring due to linkable outputs.



A bifunctional PNOZelog – Minimum space, maximum functionality.

As a result of the internal logic AND operation, two safety functions can be covered simultaneously – with just a single unit!

**Your benefits at a glance**

- ▶ Less wiring thanks to simple logic operations (AND/OR)
- ▶ High availability thanks to extended diagnostics
- ▶ Consistent use of semiconductor technology means no maintenance is necessary – there are no malfunctions due to contact welding, contamination, bounce or burning
- ▶ Continuous self-checks provide the highest level of safety – fault detection is not linked to the on/off cycle
- ▶ Long service life, even with frequent operations or cyclical functions
- ▶ Safe switching operations even on the smallest of loads
- ▶ Rapid commissioning thanks to plug-in terminals; no additional tools are required
- ▶ Complete solution comprising evaluation devices, compatible sensor technology and control and signal devices



PNOZelog can be linked through logic AND/OR operations.

**“2-in-1” – the bifunctional PNOZelog**

Do you require E-STOP or safety gate monitoring within a compact safety unit? Monitor two safety functions simultaneously with just a single unit. You save on wiring. With a width of just 22.5 mm, the space requirement within the control cabinet is reduced to a minimum. Maximum functionality is achieved through the internal logic AND operation. Each safety function has a separate signal output.

- ▶ PNOZ e5.11p simultaneously monitors an E-STOP/safety gate combination or two safety gates
- ▶ The PNOZ e5.13p can also be connected to the safety switches PSENmag





Keep up-to-date on safety relays PNOZelog:







 Webcode 0209

Online information at [www.pilz.com](http://www.pilz.com)

## ► Selection guide – PNOZelog

### Safety relays PNOZelog

Type	Application					Performance Level (PL) – EN ISO 13849-1
						
PNOZ e1p	◆	◆	◆			e
PNOZ e1.1p	◆	◆	◆			e
PNOZ e1vp	◆	◆	◆			e
PNOZ e2.1p				◆	EN 574, Type IIIC	e
PNOZ e2.2p				◆	EN 574, Type IIIA	e
PNOZ e3.1p		◆				e
PNOZ e3vp		◆				e
PNOZ e4.1p					◆	d
PNOZ e4vp					◆	d
PNOZ e5.11p	◆	◆				e
PNOZ e5.13p	◆	◆				e
PNOZ e6.1p	◆	◆	◆			e
PNOZ e6vp	◆	◆	◆			e
PNOZ e7p	◆	◆	◆			e
PNOZ e8.1p with PLID d1	◆	◆				d

Safety Integrity Level (SIL) CL – claim limit in accordance with IEC 62061	Semiconductor outputs		Relay outputs		Link	
	Safety-related	Non-safety-related	Safety-related			
	 	 				
3	2	1	-	-		
3	2	1	-	-	◆	◆
3	2	◆	1	-	◆	◆
3	2	1	-	-	◆	◆
1	2	1	-	-	◆	◆
3	2	1	-	-	◆	◆
3	2	◆	1	-	◆	◆
2	2	1	-	-	◆	◆
2	2	◆	1	-	◆	◆
3	2	2	-	-	◆ <sup>1)</sup>	
3	2	2	-	-	◆ <sup>1)</sup>	
3	2	1	4	-	◆	◆
3	2	◆	1	4	◆	◆
3	2	1	-	-	◆	
2	2	2	-	-	◆	◆

<sup>1)</sup> Also AND-linked internally

Technical documentation on safety relays PNOZelog:

 Webcode 0685

Online information at [www.pilz.com](http://www.pilz.com)

## ► Technical details – PNOZelog

### Safety relays PNOZelog



PNOZ e1.1p



PNOZ e2.1p



PNOZ e3.1p



PNOZ e4.1p

Type	Application area	Outputs	Outputs: Voltage/ current/ rating
<b>PNOZ e1p</b>	Emergency stop, safety gate and light beam monitoring	Using semiconductor technology: ▶ 2 safety outputs ▶ 1 auxiliary output, can be switched to a diagnostic output ▶ 2 test pulse outputs	24 VDC/ 2 A/50 W
<b>PNOZ e1.1p</b>	Emergency stop, safety gate and light beam monitoring	Using semiconductor technology: ▶ 2 safety outputs ▶ 1 auxiliary output, can be switched to a diagnostic output ▶ 2 test pulse outputs	24 VDC/ 2 A/50 W
<b>PNOZ e1vp</b>	Emergency stop, safety gate and light beam monitoring	Using semiconductor technology: ▶ 2 safety outputs delayed/ instantaneous, delay-on de-energization selectable ▶ 1 auxiliary output, can be switched to a diagnostic output ▶ 2 test pulse outputs	24 VDC/ 2 A/50 W
<b>PNOZ e2.1p</b> <b>PNOZ e2.2p</b>	PNOZ e2.1p: in accordance with EN 574, requirement class IIIC; PNOZ e2.2p: in accordance with EN 574, requirement class IIIA: Two-hand monitoring	Using semiconductor technology: ▶ 2 safety outputs ▶ 1 auxiliary output, can be switched to a diagnostic output ▶ 2 test pulse outputs	24 VDC/ 2 A/50 W
<b>PNOZ e3.1p</b>	Safety gate monitoring	Using semiconductor technology: ▶ 2 safety outputs ▶ 1 auxiliary output, can be switched to a diagnostic output ▶ 2 test pulse outputs	24 VDC/ 2 A/50 W
<b>PNOZ e3vp</b>	Safety gate monitoring	Using semiconductor technology: ▶ 2 safety outputs delayed/ instantaneous, delay-on de-energization selectable ▶ 1 auxiliary output, can be switched to a diagnostic output ▶ 2 test pulse outputs	24 VDC/ 2 A/50 W
<b>PNOZ e4.1p</b>	Evaluation device for safety mats	Using semiconductor technology: ▶ 2 safety outputs ▶ 1 auxiliary output, can be switched to a diagnostic output ▶ 2 test pulse outputs	24 VDC/ 2 A/50 W

#### Common features

- ▶ Supply voltage ( $U_B$ ): 24 VDC
- ▶ Dimensions (H x W x D): 101/94<sup>1)</sup> x 22.5 x 121 mm

Features	Order number	
	Spring-loaded terminals	Plug-in screw terminals
<ul style="list-style-type: none"> <li>▶ Evaluation device for non-contact, coded safety switches PSENcode</li> <li>▶ Monitored or automatic reset can be selected</li> <li>▶ Selectable monitoring of shorts across contacts</li> </ul>	784 130	774 130
<ul style="list-style-type: none"> <li>▶ Evaluation device for non-contact, coded safety switches PSENcode</li> <li>▶ Monitored or automatic reset can be selected</li> <li>▶ One AND and one OR input for logic AND/OR connections between several PNOZelog units</li> <li>▶ Selectable monitoring of shorts across contacts</li> </ul>	784 133	774 133
<ul style="list-style-type: none"> <li>▶ Evaluation device for non-contact, coded safety switches PSENcode</li> <li>▶ Monitored or automatic reset can be selected</li> <li>▶ One AND and one OR input for logic AND/OR connections between several PNOZelog units</li> <li>▶ Selectable monitoring of shorts across contacts</li> </ul>	<ul style="list-style-type: none"> <li>▶ 10 s _____ 784 131</li> <li>▶ 300 s _____ 784 132</li> </ul>	<ul style="list-style-type: none"> <li>▶ 10 s _____ 774 131</li> <li>▶ 300 s _____ 774 132</li> </ul>
<ul style="list-style-type: none"> <li>▶ One AND and one OR input for logic AND/OR connections between several PNOZelog units</li> <li>▶ Shorts across contacts are monitored via two test pulse outputs</li> <li>▶ Status display</li> <li>▶ Feedback loop for monitoring external contactors</li> </ul>	<ul style="list-style-type: none"> <li>▶ PNOZ e2.1p _____ 784 136</li> <li>▶ PNOZ e2.2p _____ 784 135</li> </ul>	<ul style="list-style-type: none"> <li>▶ PNOZ e2.1p _____ 774 136</li> <li>▶ PNOZ e2.2p _____ 774 135</li> </ul>
<ul style="list-style-type: none"> <li>▶ Evaluation device for position switches and for non-contact, magnetic safety switches PSENmag (Series 2)</li> <li>▶ Monitored or automatic reset can be selected</li> <li>▶ One AND and one OR input for logic AND/OR connections between several PNOZelog units</li> <li>▶ Selectable monitoring of shorts across contacts</li> </ul>	784 139	774 139
<ul style="list-style-type: none"> <li>▶ Evaluation device for position switches and for non-contact, magnetic safety switches PSENmag (Series 2)</li> <li>▶ Monitored or automatic reset can be selected</li> <li>▶ One AND and one OR input for logic AND/OR connections between several PNOZelog units</li> <li>▶ Selectable monitoring of shorts across contacts</li> </ul>	<ul style="list-style-type: none"> <li>▶ 10 s _____ 784 137</li> <li>▶ 300 s _____ 784 138</li> </ul>	<ul style="list-style-type: none"> <li>▶ 10 s _____ 774 137</li> <li>▶ 300 s _____ 774 138</li> </ul>
<ul style="list-style-type: none"> <li>▶ Used to connect Mayser safety mats, type: SM/BK</li> <li>▶ Suitable for controlling PSS/SafetyBUS p/PNOZmulti</li> <li>▶ One AND and one OR input for logic AND/OR connections between several PNOZelog units</li> <li>▶ With or without reset function</li> </ul>	784 180	774 180



<sup>1)</sup> Height with spring-loaded terminals / plug-in screw terminals

Technical documentation on safety relays PNOZelog:

Webcode 0685

Online information at [www.pilz.com](http://www.pilz.com)

## ► Technical details – PNOZelog

### Safety relays PNOZelog



PNOZ e5.11p



PNOZ e5.13p



PNOZ e6.1p



PNOZ e7p

Type	Application area	Outputs	Outputs: Voltage/ current/ rating
<b>PNOZ e4vp</b>	Evaluation device for safety mats	Using semiconductor technology: ▶ 2 safety outputs delayed/instantaneous, delay-on de-energization selectable ▶ 1 auxiliary output, can be switched to a diagnostic output ▶ 2 test pulse outputs	24 VDC/ 1.5 A/40 W
<b>PNOZ e5.11p</b>	Combined unit for monitoring emergency switching off relay and/or safety gate, AND-linked internally	Using semiconductor technology: ▶ 2 safety outputs ▶ 2 auxiliary outputs	24 VDC/ 1.5 A/40 W
<b>PNOZ e5.13p</b>	Combined unit for monitoring emergency switching off relay and/or safety gate, AND-linked internally	Using semiconductor technology: ▶ 2 safety outputs ▶ 2 auxiliary outputs	24 VDC/ 1.5 A/40 W
<b>PNOZ e6.1p</b>	Emergency stop, safety gate and light beam monitoring	Using semiconductor technology: ▶ 2 safety outputs ▶ 1 auxiliary output, can be switched to a diagnostic output ▶ 2 test pulse outputs Relay outputs: ▶ 4 safety contacts (N/O)	Outputs using semiconductor technology: 24 VDC/4 A/50 W Relay outputs: DC1: 24 V/6 A/150 W
<b>PNOZ e6vp</b>	Emergency stop, safety gate and light beam monitoring	Using semiconductor technology: ▶ 2 safety outputs delayed/instantaneous, delay-on de-energization selectable ▶ 1 auxiliary output, can be switched to a diagnostic output ▶ 2 test pulse outputs Relay outputs: ▶ 4 safety contacts (N/O)	Outputs using semiconductor technology: 24 V/4 A/50 W Relay outputs: DC1: 24 V/6 A/150 W
<b>PNOZ e7p</b>	Safety light beam devices, emergency stop pushbuttons, safety gate limit switches, reset buttons	Using semiconductor technology: ▶ 2 safety outputs ▶ 2 test pulse outputs ▶ 1 auxiliary output	Outputs using semiconductor technology: 24 VDC
<b>PNOZ e8.1p</b>	Evaluation device for safe line inspection with PLID d1	Using semiconductor technology: ▶ 2 safety outputs ▶ 2 auxiliary outputs	24 VDC/ 1.5 A/40 W

#### Common features

- ▶ Supply voltage ( $U_B$ ): 24 VDC
- ▶ Dimensions (H x W x D): 101/94<sup>1)</sup> x 22.5 x 121 mm,  
PNOZ e6.1p and PNOZ e6vp: 101/94<sup>1)</sup> x 45 x 121 mm

Features	Order number	
	Spring-loaded terminals	Plug-in screw terminals
<ul style="list-style-type: none"> <li>▶ Used to connect Mayser safety mats, type: SM/BK</li> <li>▶ Suitable for controlling PSS/PNOZmulti</li> <li>▶ One AND and one OR input for logic AND/OR connections between several PNOZelog units</li> <li>▶ With or without reset function</li> </ul>	10 s _____ 784181	<ul style="list-style-type: none"> <li>▶ 10 s _____ 774 181</li> <li>▶ 300 s _____ 774 182</li> </ul>
<ul style="list-style-type: none"> <li>▶ 2 safety functions in one unit, AND-linked internally</li> <li>▶ Evaluation device for position switches and non-contact, coded safety switches PSENcode</li> <li>▶ One AND input for logic AND operations between several PNOZelog units</li> <li>▶ Monitored or automatic reset can be selected</li> </ul>	784 190	774 190
<ul style="list-style-type: none"> <li>▶ 2 safety functions in one unit, AND-linked internally</li> <li>▶ Evaluation device for position switches, non-contact safety switches PSENcode and PSENmag (Series 2.X)</li> <li>▶ Monitored or automatic reset can be selected</li> <li>▶ One AND input for logic AND operations between several PNOZelog units</li> </ul>	784 191	774 191
<ul style="list-style-type: none"> <li>▶ Connection option for E-STOP pushbuttons, safety gate limit switches, reset buttons, safety mats and safe edges made by Haake, proximity switch evaluation devices</li> <li>▶ Monitored or automatic reset can be selected</li> <li>▶ One AND and one OR input for logic AND/OR connections between several PNOZelog units</li> <li>▶ Selectable monitoring of shorts across contacts</li> </ul>	784 192	774 192
<ul style="list-style-type: none"> <li>▶ Connection option for E-STOP pushbuttons, safety gate limit switches, reset buttons, safety mats and safe edges made by Haake, proximity switch evaluation devices</li> <li>▶ Monitored or automatic reset can be selected</li> <li>▶ One AND and one OR input for logic AND/OR connections between several PNOZelog units</li> <li>▶ Selectable monitoring of shorts across contacts</li> </ul>	784 193	774 193
<ul style="list-style-type: none"> <li>▶ Connection option for E-STOP pushbuttons, safety gate limit switches, reset buttons, safety mats and safe edges made by Haake, proximity switch evaluation devices</li> <li>▶ Monitored or automatic reset can be selected</li> <li>▶ One AND and one OR input for logic AND/OR connections between several PNOZelog units</li> <li>▶ Selectable monitoring of shorts across contacts</li> </ul>	784 197	774 197
<ul style="list-style-type: none"> <li>▶ Monitored or automatic reset can be selected</li> <li>▶ Monitoring of shorts across contacts can be selected for E-STOP application</li> </ul>	784 198	774 198

<sup>1)</sup> Height with spring-loaded terminals / plug-in screw terminals



Technical documentation on safety relays PNOZelog:

Webcode 0685

Online information at [www.pilz.com](http://www.pilz.com)

## ▶ Safe line inspection device PLIDdys – Safe power-

The safe line inspection device PLIDdys provides safe power-up on two-wire connections, providing maximum safety on long cable routes.



PLID d1 + PNOZ e8.1p

With PLIDdys, unintended power-up or plant start-up can be excluded in the event of an error. This is particularly beneficial on interlinked plants or on plant sections distributed over a wide area, which may not always be clearly visible. An extremely compact design means it can be easily retrofitted into an existing plant and PLIDdys can be incorporated into the sensor or switch, for example. In combination with the evaluation device PNOZ e8.1p, the line inspection device PLIDdys is the optimum solution for safe cables/connections.



### Selection guide – Safe line inspection device PLIDdys



PLID d1

Type	Application area
PLID d1	Line inspection device PLIDdys in combination with the evaluation device PNOZ e8.1p
PNOZ e8.1p	Evaluation device for safe line inspection with PLID d1



# up in conjunction with PNOZ e8.1p

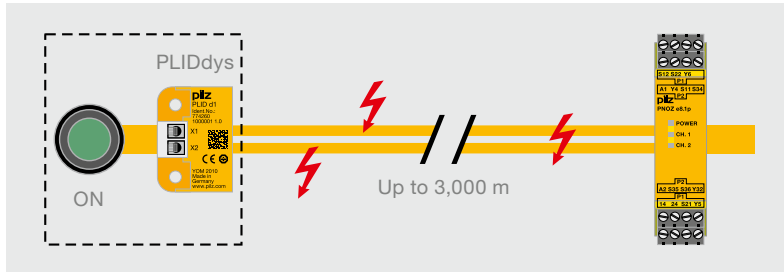

Monitoring for potential wiring errors and protection against power-up in the event of an error.

## Example applications of the line inspection device PLIDdys

Safe inspection of long cable routes in critical environments

- ▶ Cable cars, lift systems
- ▶ Conveyor belts in open cast mining or underground
- ▶ Tunnel boring machinery
- ▶ Press lines
- ▶ Fairground rides
- ▶ Drag chain applications
- ▶ Interlinked/distributed plant sections

## Your benefits at a glance

- ▶ All potential wiring errors are detected through constant line inspection by PLIDdys, no need for customized tests
- ▶ PLIDdys can be looped into the existing wiring, so few additional costs
- ▶ Easy to integrate into existing plants thanks to its small dimensions
- ▶ Saves costs, as the prevailing periphery can be retained
- ▶ Suitable for cable lengths up to 3,000 meters

Keep up-to-date on safe line inspection device PLIDdys:



Webcode 6892

Online information at [www.pilz.com](http://www.pilz.com)

Dimensions (L x W x H) in mm	Features	Order number
36 x 26 x 12.1 <sup>1)</sup>	<ul style="list-style-type: none"> <li>▶ Cable cross section of 0.5 mm<sup>2</sup> to 1.5 mm<sup>2</sup></li> <li>▶ Maximum cable length 3,000 m</li> <li>▶ Cable resistance maximum 220 Ohm</li> <li>▶ Supply voltage 24 VDC</li> <li>▶ Weight 10 g</li> <li>▶ Temperature range -30 °C ... +70 °C</li> </ul>	<ul style="list-style-type: none"> <li>▶ PLID d1 _____ 774 260</li> <li>▶ PLID d1 C<sup>3)</sup> _____ 784 260</li> </ul>
101/94 <sup>2)</sup> x 22.5 x 121	<ul style="list-style-type: none"> <li>▶ Outputs using semiconductor technology:                             <ul style="list-style-type: none"> <li>- 2 safety outputs</li> <li>- 2 auxiliary outputs</li> </ul> </li> <li>▶ Outputs: Voltage/current/rating: 24 VDC/1.5 A/40 W</li> <li>▶ Monitored or automatic reset can be selected</li> <li>▶ Monitoring of shorts across contacts can be selected for E-STOP application</li> </ul>	<ul style="list-style-type: none"> <li>▶ PNOZ e8.1p with spring-loaded terminals _____ 784 198</li> <li>▶ PNOZ e8.1p with plug-in screw terminals _____ 774 198</li> </ul>

<sup>1)</sup>Height of version with spring-loaded terminal 12.5 mm

<sup>2)</sup>Height with spring-loaded terminals / plug-in screw terminals

<sup>3)</sup>Version with spring-loaded terminal



## ► Safety relays PNOZpower

The safety relays PNOZpower are suitable for monitoring emergency stop devices, safety gates and light beam devices. PNOZpower can switch currents of up to 16 A AC/DC per contact. An overall breaking capacity of 40 A is available per module.



PNOZ p1p



PNOZ po3p

### Switching high loads safely

External contactors and contactor combinations are no longer required. The control circuit and main circuit are switched with one safety relay. The EC type examination is valid for the whole safety circuit.

### Modular and flexible

The base module processes the inputs; the output modules are specifically matched to the respective load. The number and capacity of the required safety contacts can be scaled, depending on the application. A maximum of five modules can be connected to the base unit. Modules are wired to the base unit via an internal bus system.

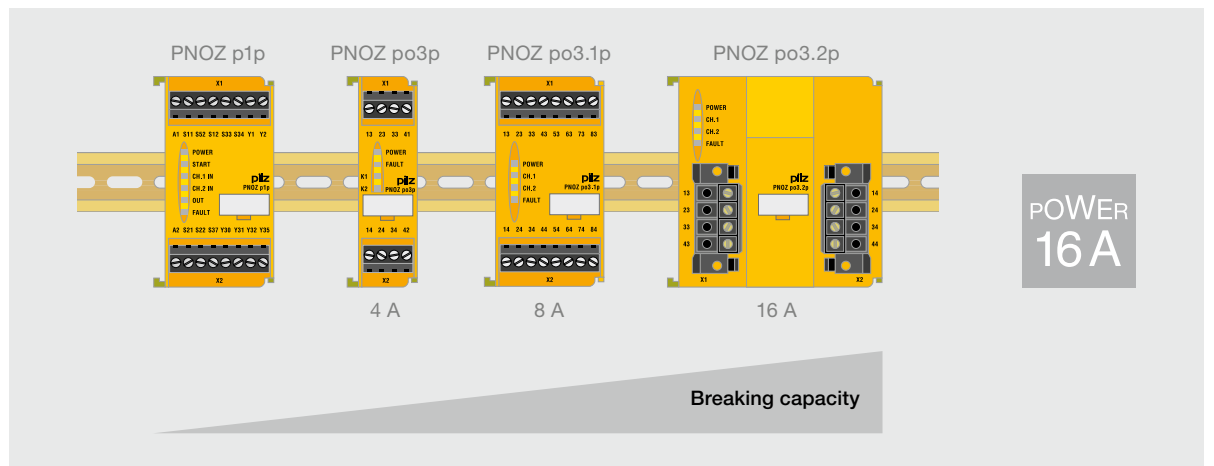

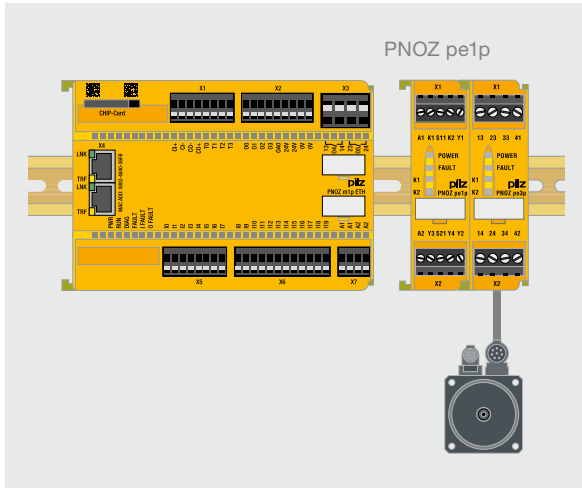

**Volt-free switching with the PNOZ pe1p control module**

In conjunction with at least one expansion module from the PNOZpower range, the control module PNOZ pe1p safely shuts down motors or supply voltages on valves and contactors.

**The PNOZ pe1p can be driven via:**

- ▶ The safety relays PNOZelog, PNOZ X and PNOZsigma
- ▶ The configurable control system PNOZmulti

The benefit to you: Volt-free switching up to 16 A.

**Your benefits at a glance**

- ▶ External contactor combinations and their respective wiring are no longer required, saving costs, space and commissioning time
- ▶ Diagnostics via LED: operating and fault status can be scanned on each module, resulting in fewer downtimes
- ▶ Plug-in connection terminals: pre-wired and easy to exchange if there is a fault
- ▶ Redundant load switching
- ▶ Scalable and flexible by selecting compatible modules – you only pay for the functions that you actually use
- ▶ Complete solution comprising evaluation devices, compatible sensor technology and control and signal devices

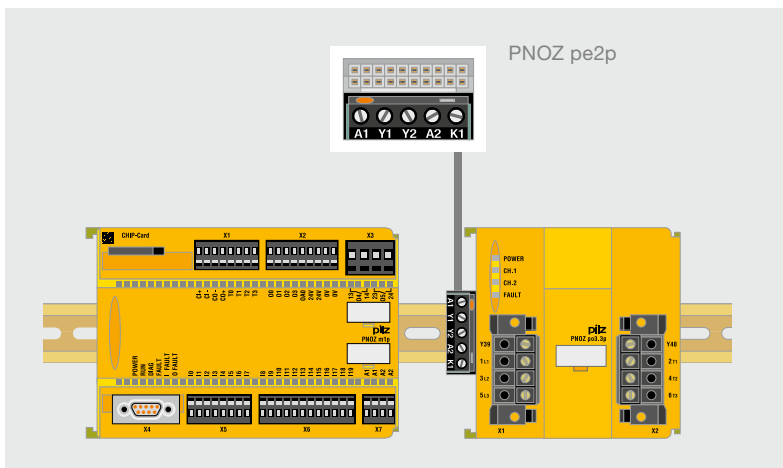

Safety relays PNOZpower and the configurable control system PNOZmulti are easily combined using the coupling connector PNOZ pe2p.

**Connection to PNOZmulti**

Specially developed for connection to the configurable control system PNOZmulti, PNOZpower units can be docked via the coupling connector PNOZ pe2p.





Keep up-to-date on safety relays PNOZpower:

 Webcode 5238

Online information at [www.pilz.com](http://www.pilz.com)

## ► Selection guide – PNOZpower

### Base units – Safety relays PNOZpower

Type	Application area	Application				Performance Level (PL) – EN ISO 13849-1
						
PNOZ p1p	Base unit	◆	◆	◆		e
PNOZ p1vp	Base unit, delayed	◆	◆	◆	◆	e (d) <sup>1)</sup>

### Contact expansion modules – Safety relays PNOZpower

Type	Output contacts		Performance Level (PL) – EN ISO 13849-1
	Safety-related	Non-safety-related	
			
PNOZ po3p	3	1	e
PNOZ po3.1p	8	-	e
PNOZ po3.2p	4	-	e
PNOZ po3.3p	3	-	e
PNOZ po4p	4	-	e

### Accessories – Safety relays PNOZpower

Type	Application area	Application	Performance Level (PL) – EN ISO 13849-1
PNOZ pe1p	Control module	For control via safety contacts or safe semiconductor outputs	e
PNOZ pe2p	Bus interface	Coupling connector for connecting PNOZpower expansion modules to a higher-level control system	e
PNOZ pps1p	Power supply	-	-

Safety Integrity Level (SIL) CL – claim limit in accordance with IEC 62061	Number of expansion modules	Supply voltage	Dimensions (H x W x D) in mm
3	Min. 1, max. 4 expansion modules	24 VDC	94 x 45 x 135
3	Min. 1, max. 8 expansion modules (max. 4 delayed and 4 instantaneous)	24 VDC	94 x 45 x 135

<sup>1)</sup> Value applies for instantaneous (delayed) safety contacts

Safety Integrity Level (SIL) CL – claim limit in accordance with IEC 62061	Number of expansion modules			Dimensions (H x W x D) in mm
	AC1	AC3	DC1:	
3	240 V/4 A/960 VA	-	24 V/4 A/96 W	94 x 22.5 x 121
3	240 V/8 A/2000 VA	-	24 V/8 A/200 W	94 x 45 x 121
3	240 V/16 A/4000 VA	-	24 V/16 A/400 W	94 x 90 x 135
3	240 V/16 A/4000 VA 400 V/10 A/4000 VA 500 V/8 A/4000 VA	240 V/3.0 kW 400 V/5.5 kW 500 V/4.0 kW	24 V/16 A/400 W	94 x 90 x 135
3	240 V/4 A/960 VA	-	24 V/4 A/96 W	94 x 22.5 x 121

Safety Integrity Level (SIL) CL – claim limit in accordance with IEC 62061	Number of expansion modules	Supply voltage	Dimensions (H x W x D) in mm
3	Min. 1, max. 4 expansion modules	24 VDC	94 x 22.5 x 121
3	Min. 1, max. 6 expansion modules	24 VDC	29 x 23.5 x 22
-	-	100 ... 240 VAC	94 x 45 x 121

Technical documentation on safety relays PNOZelog:

 Webcode 0685

Online information at [www.pilz.com](http://www.pilz.com)

## ► Technical details – PNOZpower

### Safety relays PNOZpower



PNOZ p1p



PNOZ pe1p



PNOZ pe2p



PNOZ pps1p



PNOZ po3p



PNOZ po3.2p

Type	Application area	Inputs/outputs	Supply voltage
<b>PNOZ p1p</b>	Base unit	2 semiconductor outputs	24 VDC
<b>PNOZ p1vp</b>	Base unit, delayed	2 semiconductor outputs	24 VDC
<b>PNOZ pe1p</b>	Control module	Expansion module control output connected to the PNOZpower bus	24 VDC
<b>PNOZ pe2p</b>	Bus interface	Output connected to PNOZpower bus	24 VDC
<b>PNOZ pps1p</b>	Power supply	-	100 ... 240 VAC/DC
<b>PNOZ po3p, PNOZ po4p</b>	Expansion modules	<ul style="list-style-type: none"> <li>► PNOZ po3p:                             <ul style="list-style-type: none"> <li>- 3 safety contacts (N/O)</li> <li>- 1 auxiliary contact (N/C)</li> </ul> </li> <li>► PNOZ po4p:                             <ul style="list-style-type: none"> <li>- 4 safety contacts (N/O)</li> </ul> </li> </ul>	Via PNOZpower bus
<b>PNOZ po3.1p</b>	Expansion module	8 safety contacts (N/O)	Via PNOZpower bus
<b>PNOZ po3.2p</b>	Expansion module	4 safety contacts (N/O)	Via PNOZpower bus
<b>PNOZ po3.3p</b>	Expansion module	3 safety contacts (N/O)	Via PNOZpower bus

Features	Order number
	Plug-in screw terminals
<ul style="list-style-type: none"> <li>▶ Dual-channel wiring, with or without detection of shorts across contacts</li> <li>▶ Monitored or automatic reset can be selected</li> <li>▶ Connection between PNOZ p1p and expansion modules via PNOZpower bus, using jumpers on the back of the unit</li> </ul>	773 300
<ul style="list-style-type: none"> <li>▶ Dual-channel wiring, with or without detection of shorts across contacts</li> <li>▶ Monitored or automatic reset can be selected</li> <li>▶ Delay time can be selected via rotary switch and potentiometer</li> <li>▶ Connection between PNOZ p1vp and expansion modules via PNOZpower bus, using jumpers on the back of the unit</li> </ul>	<ul style="list-style-type: none"> <li>▶ 30 s _____ 773 950</li> <li>▶ 300 s _____ 773 951</li> </ul>
<ul style="list-style-type: none"> <li>▶ 1-channel operation, without detection of shorts across contacts</li> <li>▶ 2-channel operation, with or without detection of shorts across contacts</li> <li>▶ Connection between PNOZ pe1p and expansion modules via PNOZpower bus, using jumpers on the back of the unit</li> <li>▶ Status indicator for output relay, supply voltage and fault</li> <li>▶ Connection for feedback loop</li> </ul>	773 900
<ul style="list-style-type: none"> <li>▶ Control via safety contacts or safe semiconductor outputs</li> <li>▶ 1-channel operation, without detection of shorts across contacts</li> <li>▶ Connection between PNOZ pe2p and expansion modules via the PNOZpower bus</li> </ul>	779 125
<ul style="list-style-type: none"> <li>▶ Galvanic isolation</li> <li>▶ Short circuit-proof</li> <li>▶ 24 VDC at the plug-in connector on the back of the unit for the PNOZpower bus and at the terminals</li> <li>▶ LEDs for supply voltage, output voltage and fault</li> </ul>	773 200
<ul style="list-style-type: none"> <li>▶ 2-channel operation with the ability to detect short circuits via the base unit</li> <li>▶ LEDs for switch status of channels 1/2, supply voltage and fault</li> </ul>	<ul style="list-style-type: none"> <li>▶ PNOZ po3p _____ 773 634</li> <li>▶ PNOZ po4p _____ 773 635</li> </ul>
	773 630
	773 631
<ul style="list-style-type: none"> <li>▶ 2-channel operation with the ability to detect short circuits via the base unit</li> <li>▶ LEDs for switch status of channels 1/2, supply voltage and fault</li> <li>▶ Suitable for safety-related switching of loads with utilization category AC3 (e.g. motor)</li> <li>▶ External start/stop input for non-safety-related load switching</li> </ul>	773 632



Relays

Technical documentation on safety relays PNOZpower:

Webcode 0685

Online information at [www.pilz.com](http://www.pilz.com)

## ► Configurable control systems PNOZmulti



Many functions, one solution – Configurable control systems bridge the gap between classic safety relays and programmable control systems. The configurable control systems PNOZmulti are convincing, with numerous benefits! The software tool PNOZmulti Configurator, for example, impresses by its simple handling: it is installed, opened and operated intuitively. You also have the widest range of options for carrying out diagnostics – for high plant availability and low downtimes. The diversity of fieldbus and communication options is a huge plus on the PNOZmulti. Use of the system does not depend on the higher level operational control system. A variety of expansion modules provide maximum flexibility within the application.



### **Configurable control systems PNOZmulti 2**

The configurable control systems PNOZmulti 2 are suitable for use from four safety functions and above. The full function range of the “classic” PNOZmulti is provided on a 45 mm width. The base unit has an illuminated display – for even faster diagnostics.



### **Configurable small control systems PNOZmulti Mini**

The configurable small control systems PNOZmulti Mini are mainly used for three safety functions and above. The small control systems have fewer expansion modules than PNOZmulti and PNOZmulti 2.



### **Configurable safety systems PNOZmulti**

The configurable safety systems PNOZmulti are suitable for use from four safety functions and above. The system is characterized by a diverse range of modules and communication options.



Benefit from a faster time-to-market compared with conventional solutions! You save time and costs in all engineering phases: during planning, configuration, commissioning, operation and maintenance.

**High degree of market success thanks to a complete system**

The diversity of fieldbus and communication options on PNOZmulti (PROFIBUS, PROFINET, EtherCAT, CANopen, POWERLINK, ...) is a great benefit. It means that use of the PNOZmulti does not depend on the higher level operational control system. Various expansion modules, such as the safe speed and standstill monitor, safe motion monitoring modules or safe analog input modules enable flexible application.

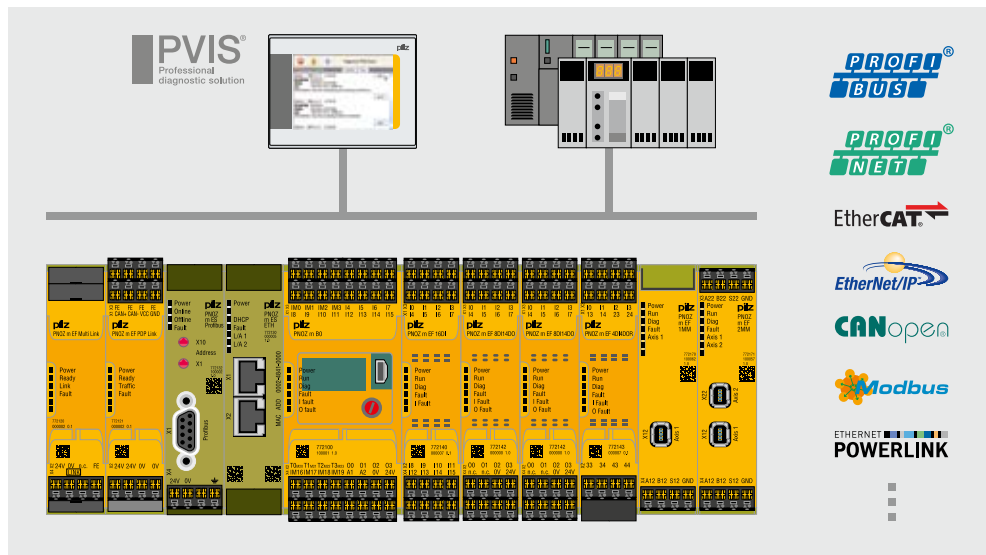

PROFI<sup>®</sup>  
BUS

PROFI<sup>®</sup>  
NET

EtherCAT

EtherNet/IP

CANopen

Modbus

ETHERNET  
POWERLINK

Small control systems

Configurable control systems PNOZmulti: the worldwide safety standard for all machine types.

**Potential for rationalization: safety components cover automation tasks**

The configurable control systems PNOZmulti are mainly used to implement multiple safety functions. They are also powerful enough to assume complete machine control on smaller machines. Machine builders and operators can rely on high-quality, available products. Also they no longer need an additional control system and so can make savings in a range of areas, from hardware costs and space in the control cabinet to procurement and stock holding costs.



Keep up-to-date on configurable control systems PNOZmulti:



Webcode 10522

Online information at [www.pilz.com](http://www.pilz.com)

## ► Configurable control systems PNOZmulti



With the PNOZmulti Configurator you can create your safety circuit quite easily on the PC – that includes planning, configuration, documentation and commissioning. The wide variety of components on this tool is impressive. And it's very easy to handle: install, open, work intuitively! The software has a broad function and command range, so that even larger projects can be implemented without problem. Working with custom macros saves you time and effort.

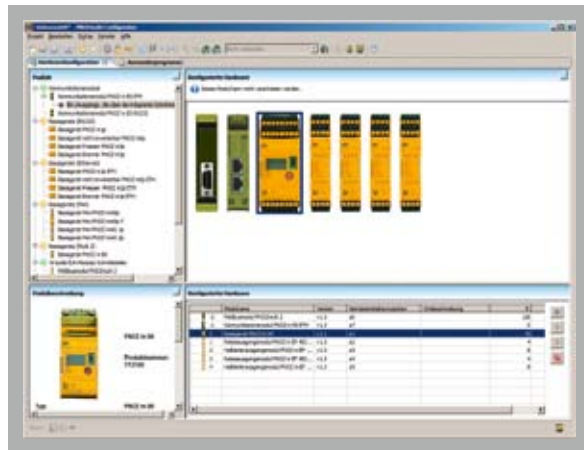

PNOZmulti Configurator – Simple configuration.

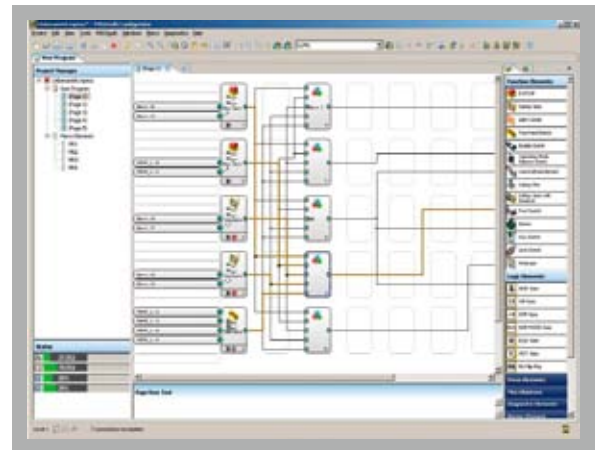

More logic connections are available to you with macros.

Technical details for the PNOZmulti Configurator can be found on page 84.

Keep up-to-date on the software tool PNOZmulti Configurator:



Webcode 8633

Online information at [www.pilz.com](http://www.pilz.com)

### Flexible to use and child's play to operate

The graphics-based user interface conforms to the Windows® standard; the elements of the safety circuit are available as icons or in selection menus.

First select the necessary hardware via drag & drop. The hardware consists of a base unit and, if necessary, expansion modules. The number of available inputs and outputs is displayed in table form. The software tool provides support, for example, by listing the expansion modules available for the selected base unit. The tool can also help if the permitted number of expansion modules has been exceeded or if modules have been positioned incorrectly. Online help with documentation is always available during configuration.

The completed safety circuit is transferred from the PNOZmulti Configurator to a PNOZmulti base unit on a chip card.

### Enter a new dimension with macro elements

The logic connections that are defined between inputs and outputs can be combined into macro elements. Once created, macro elements are stored in the macro library. They are then available for use in all further configurations. A simple import and export function and the ability to edit macros within the editor reduce your engineering time and save costs. Macros can also be read and write protected, so protecting your expertise.

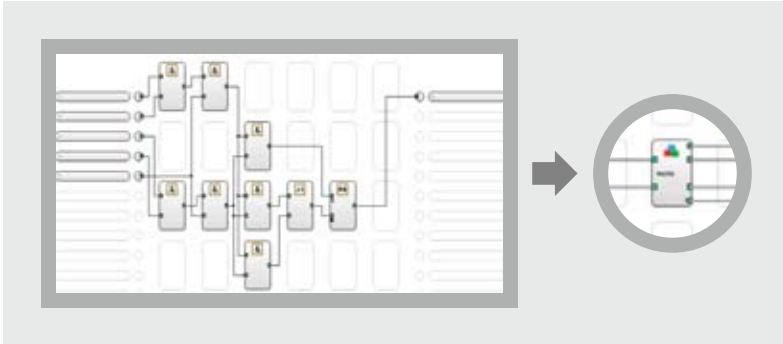

A wide range of logic connections can be combined to form a macro.

### High plant availability and short downtimes thanks to detailed diagnostic options

On the configurable control systems PNOZmulti you have the widest range of options for carrying out diagnostics. You can take advantage of our operator terminals PMI, the interface Ethernet TCP/IP and Modbus TCP, the status message to the connected PLC control system or the higher level fieldbus. Various fieldbus modules are available for this last option. They can be used to read diagnostic data and to set virtual inputs/outputs for non-safety-related outputs. The modules are simple to configure via the PNOZmulti Configurator.



### Reduce downtimes with PVIS

Thanks to the modern PVIS diagnostic concept, PNOZmulti and PMI operator terminals can provide an overall, integrated diagnostic solution. If a fault occurs, features such as plain text messages with precise information on the location, clearly defined responsibilities and integrated first fault display all ensure that production is quickly restarted. The PNOZmulti Configurator contains the PNOZmulti project, texts for diagnostics, proposed solutions and more. The benefits are obvious: there's less configuration required, greater flexibility and downtimes are reduced.

### Your benefits at a glance

- ▶ Short commissioning times thanks to simple wiring and software with preconfigured, certified blocks – simple changes and adjustments can be made later in the configuration
- ▶ Simple, universal diagnostics mean short machine downtimes and high plant availability
- ▶ Worldwide safety standard for various automation environments and different communication systems, cost effective and sustainable
- ▶ One system for safety and automation
- ▶ Safe complete solution comprising sensor technology, control technology and drive technology

Keep up-to-date on the diagnostic concept PVIS:



## ► Configurable control system PNOZmulti 2 – the



The configurable control systems PNOZmulti 2 are used to implement multiple safety functions on plant or machinery. The system is modular and expandable, so the solution can grow with your machine as it expands or as its requirements change. A variety of expansion and communication modules are available.

*energy*  
saving by Pilz



PNOZ m B0

The base unit from PNOZmulti 2 is particularly energy efficient – it uses up to 80 % less energy than comparable products. The illuminated display is an additional benefit – it enables particularly fast commissioning and diagnostics.

### **Flexible application**

With PNOZmulti 2 you can standardize your safety! Thanks to the connection to various communication networks, PNOZmulti 2 is becoming the worldwide safety standard. The safety architecture must only be created once and can then be connected to the various master operational control systems. It can be used regardless of type of machinery or plant, country and industry.

Configurable control systems PNOZmulti 2 – worldwide safety standard for all machine types.



# future-proof solution

**PVIS<sup>®</sup>**  
Professional diagnostic solution

**Energy saving by Pilz**

### Your benefits at a glance

- ▶ Short commissioning times through simple wiring and software tool PNOZmulti Configurator
- ▶ Simple and economical to expand by selecting compatible modules
- ▶ Simple, user-friendly diagnostics mean short downtimes and high plant availability
- ▶ One system for safety and automation
- ▶ Fast time-to-market: Inputs and outputs are freely configurable
- ▶ Particularly energy efficient: Base unit consumes up to 80% less energy than comparable products
- ▶ Certified worldwide



Small control systems

Keep up-to-date on configurable control systems PNOZmulti 2:

Webcode 10522

Online information at [www.pilz.com](http://www.pilz.com)

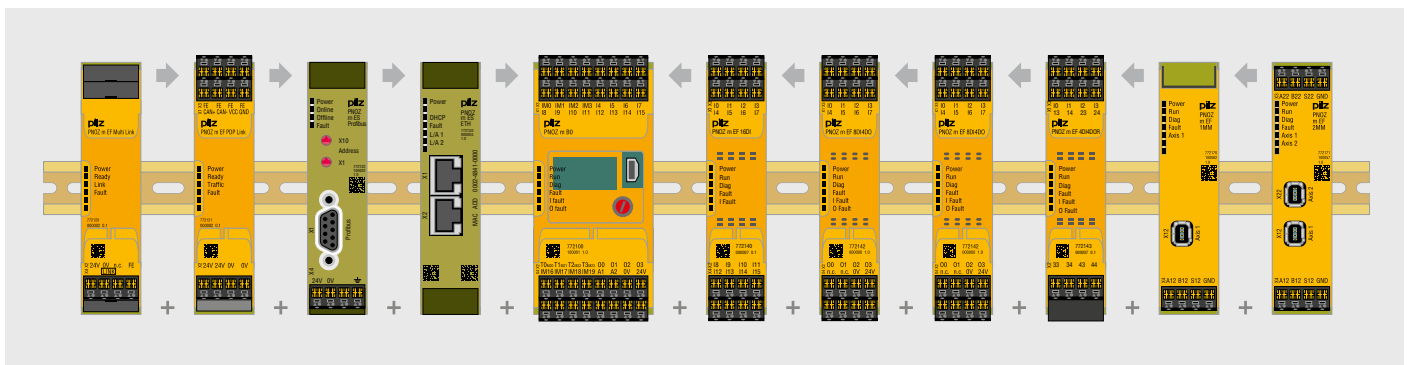

Expansion modules for various applications and connection to common fieldbus systems – that's flexibility.

## ► Expansion modules – for particular requirements



### Safe motion monitoring

The safe motion monitoring modules for the configurable control systems PNOZmulti 2 ensure safe monitoring of your drives. So plant and machinery are even more productive:

- ▶ Safety functions in accordance with EN 61800-5-2 (Adjustable speed electrical power drive systems)
- ▶ Safe Speed Range: SSR
- ▶ Safe Speed Monitor: SSM
- ▶ Safe Direction: SDI
- ▶ Safe Operating Stop: SOS

The safety functions can be implemented quickly and easily (including SS1 and SS2) using a variety of blocks.

### Flexible and robust

Modules are available for safe monitoring of one axis or two axes. The **industrial interface Mini I/O**, which is characterized by particularly high durability, enables all standard incremental encoders to be connected using drive-specific connection cables.

The safe motion monitoring modules for PNOZmulti 2 are configured easily using the software tool PNOZmulti Configurator.

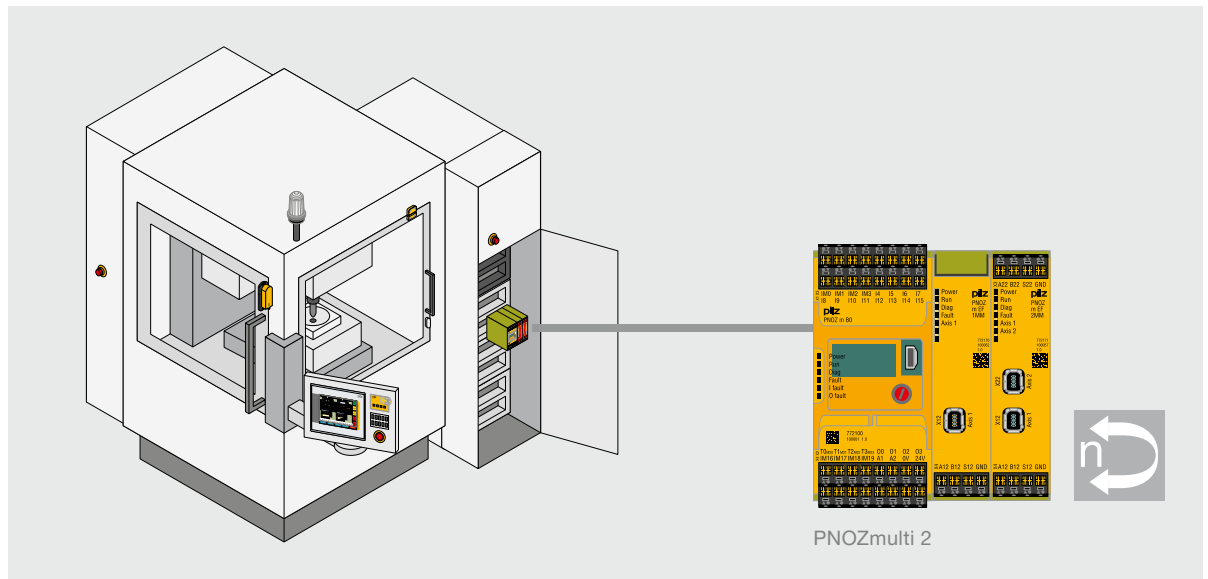

The complete solution for safe motion monitoring:  
Configurable control system PNOZmulti 2 with Pilz sensor technology and operator and visualization systems.



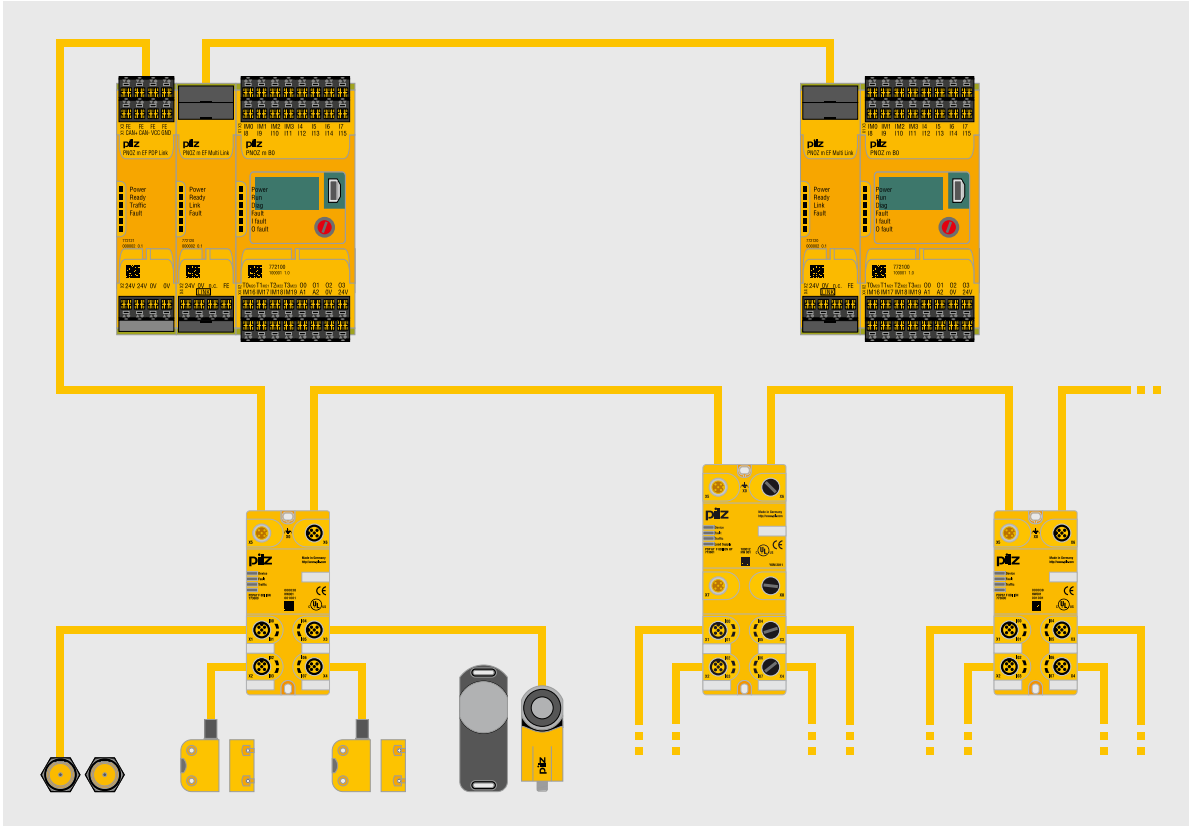

The decentralized modules PDP67 can be connected to the PNOZmulti 2 via a link module – for cost-effective, simple, decentralized expansion. A link module is also available for networking several base units.

### PNOZmulti 2 – with decentralized expansion

The configurable control systems PNOZmulti 2 can be expanded using link modules for decentralization and for safe communication between multiple base units. Safety functions on more complex plant and machinery can thus be easily implemented.

### Decentrally in the field

The PDP link module serves as the interface for the decentralized modules PDP67 (protection type IP67) to the base unit. As a result, the signals from the connected sensors are directly forwarded to this from the field for further processing. With up to 16 PDP67 modules on one base unit the number of sensors that can be connected increases by 64. This is what an economical solution looks like!

### Complex tasks – a team effort

The multi link module enables simple, safe data exchange between several base units. Thanks to the modular structure of the PNOZmulti 2 different topologies can be implemented on one base unit with up to four link modules. As a result, users can connect several PNOZmulti units to implement safety functions for complex plant and machinery.

Small control systems

## ▶ Technical details PNOZmulti 2

### PNOZmulti 2 – Base unit

Energy saving by Pilz



PNOZ m B0

Type	Application area
<b>PNOZ m B0</b>	<ul style="list-style-type: none"> <li>▶ Base unit, efficient from 4 safety functions, modular and expandable</li> <li>▶ Application range: to connect emergency stop pushbuttons, two-hand buttons, safety gate limit switches, light beam devices, scanners, enable switches, safety gate switches PSEN, operating mode selector switches, muting, safety mats, sensors</li> </ul>

#### Common features

- ▶ Can be configured with the software tool PNOZmulti Configurator
- ▶ Status indicators via LEDs

### PNOZmulti 2 – Expansion modules



PNOZ m EF 16DI



PNOZ m EF 4DI4DOR

Type	Application area
<b>PNOZ m EF 16DI</b>	Safe input module
<b>PNOZ m EF 8DI4DO</b>	Safe input/semiconductor output module
<b>PNOZ m EF 4DI4DOR</b>	Safe input/relay output module
<b>PNOZ m EF 1MM</b>	Safe monitoring of one axis
<b>PNOZ m EF 2MM</b>	Safe monitoring of two independent axes
<b>PNOZ m EF PDP Link</b>	Safe link module for connection of the decentralized modules PDP67
<b>PNOZ m EF Multi Link</b>	Safe link module for linking several PNOZmulti 2 base units

#### Common features

- ▶ Can be configured with the software tool PNOZmulti Configurator
- ▶ Status indicators via LEDs
- ▶ Max. 6 expansion modules can be connected to the right of the base unit



Features	Order number		
	Excl. terminals	Spring-loaded terminals	Plug-in screw terminals
<ul style="list-style-type: none"> <li>▶ Base unit complies with PL e of EN ISO 13849-1 and SIL CL 3 of IEC 62061; the maximum achievable value depends on the application, e.g. number of outputs</li> <li>▶ Configurable using PNOZmulti Configurator via chip card or USB interface</li> <li>▶ Exchangeable program memory</li> <li>▶ 20 safe inputs, up to 8 of which can be configured as auxiliary outputs</li> <li>▶ 4 safe semiconductor outputs, depending on the application up to PL e, SIL CL 3</li> <li>▶ 4 test pulse outputs, up to 4 of which can be configured as standard outputs</li> <li>▶ With illuminated display for error messages</li> <li>▶ State of the supply voltage, the inputs and outputs, status and device information, customized texts can be displayed</li> <li>▶ Rotary knob for menu control</li> </ul>	772 100  Mini USB cable ▶ 3 m _____ 312 992 ▶ 5 m _____ 312 993  ▶ Chip card 8 kByte 1 piece ____ 779 201 ▶ Chip card 32 kByte 1 piece ____ 779 211	751 008 (1 set)	750 008 (1 set)

Features	Order number		
	Excl. terminals	Spring-loaded terminals	Plug-in screw terminals
16 safe inputs	772 140	751 004 (1 set)	750 004 (1 set)
<ul style="list-style-type: none"> <li>▶ 8 safe inputs</li> <li>▶ 4 safe semiconductor outputs, depending on the application up to PL e, SIL CL 3</li> </ul>	772 142	751 004 (1 set)	750 004 (1 set)
<ul style="list-style-type: none"> <li>▶ 4 safe inputs</li> <li>▶ Relay outputs: 4 safety outputs, depending on the application up to PL e, SIL CL 3</li> </ul>	772 143	751 004 (1 set)	750 004 (1 set)
Support of safe drive function in accordance with EN 61800-5-2	772 170	783 542 (1 set)	793 542 (1 set)
Support of safe drive function in accordance with EN 61800-5-2	772 171	783 544 (1 set)	793 544 (1 set)
<ul style="list-style-type: none"> <li>▶ Max. 4 PDP link modules to the left of the base unit</li> <li>▶ Max. 4 decentralized modules PDP67 F 8 DI ION (VA) or PDP67 F 8 DI ION HP (VA) to the link module</li> </ul>	772 121	783 540 (1 set)	793 540 (1 set)
<ul style="list-style-type: none"> <li>▶ Point-to-point connection via 4-core shielded and twisted-pair cable</li> <li>▶ Transfer of 32 bit input data and 32 bit output data (virtual I/Os)</li> <li>▶ Max. 4 Multi link modules to the left of the base unit</li> </ul>	772 120	783 538 (1 set)	793 538 (1 set)

Keep up-to-date on:  
 ▶ Base units PNOZmulti 2

 Webcode 10523

▶ I/O modules PNOZmulti 2

 Webcode 10524

Online information at [www.pilz.com](http://www.pilz.com)

## ► Technical details PNOZmulti 2

### PNOZmulti 2 – Communication modules



Ethernet

PNOZ m ES ETH



RS232

PNOZ m ES RS232



PROFIBUS

PNOZ m ES PROFIBUS



CANopen

PNOZ m ES CANopen



EtherCAT

PNOZ m ES EtherCAT



ETHERNET POWERLINK

PNOZ m ES Powerlink



PROFINET

PNOZ m ES Profinet



EtherNet/IP

PNOZ m ES EtherNet IP

Type	Application area
PNOZ m ES ETH	Communication module with Ethernet/Modbus TCP interface
PNOZ m ES RS232	Communication module with serial interface
PNOZ m ES PROFIBUS	Communication module/ fieldbus module PROFIBUS-DP (slave)
PNOZ m ES CANopen	Communication module/ fieldbus module CANopen (Slave, CiA 301 V4.2.0)
PNOZ m ES EtherCAT	Communication module/ fieldbus module EtherCAT (slave, CANopen over EtherCAT)
PNOZ m ES Powerlink	Communication module/ fieldbus module Powerlink V2 (slave, CANopen over Ethernet)
PNOZ m ES Profinet	Communication module/ fieldbus module Profinet (I/O-Device)
PNOZ m ES EtherNet/IP	Communication module/ fieldbus module Ethernet/IP (Adapter)

#### Common features

- Can be configured with the software tool PNOZmulti Configurator
- Status indicators via LEDs
- Max. 1 communication and 1 fieldbus module can be connected to the left of the base unit

Features	Order number		
	Excl. terminals	Spring-loaded terminals	Plug-in screw terminals
<ul style="list-style-type: none"> <li>▶ Number of ETH interfaces: 2</li> <li>▶ Transmission rate 10 MBit/s or 100 MBit/s</li> <li>▶ Connection to fieldbus via RJ45 connector</li> </ul>	772 130	-	-
With serial interface RS232	772 131	783 538 (1 set)	793 538 (1 set)
<ul style="list-style-type: none"> <li>▶ Station addresses from 0 ... 99, selected via rotary switch</li> <li>▶ Transmission rate: max. 12 MBit/s</li> <li>▶ Connection to fieldbus via female 9-pin D-Sub connector</li> </ul>	772 132	783 542 (1 set)	793 542 (1 set)
<ul style="list-style-type: none"> <li>▶ Station addresses from 0 ... 99, selected via rotary switch</li> <li>▶ Transmission rate: Max. 1 MBit/s</li> <li>▶ Transmission rate selected via rotary switch</li> <li>▶ Connection to fieldbus via female 9-pin D-Sub connector</li> </ul>	772 134	783 542 (1 set)	793 542 (1 set)
<ul style="list-style-type: none"> <li>▶ Transmission rate: 100 MBit/s</li> <li>▶ max. 148 bytes TxPDO and 20 bytes RxPDO</li> <li>▶ Connection to fieldbus via RJ45 connector</li> </ul>	772 136	783 542 (1 set)	793 542 (1 set)
<ul style="list-style-type: none"> <li>▶ Transmission rate: 100 MBit/s</li> <li>▶ Connection to fieldbus via RJ45 connector</li> </ul>	772 119	783 542 (1 set)	793 542 (1 set)
<ul style="list-style-type: none"> <li>▶ Transmission rate: 100 MBit/s</li> <li>▶ Connection to fieldbus via RJ45 connector</li> </ul>	772 138	783 542 (1 set)	793 542 (1 set)
<ul style="list-style-type: none"> <li>▶ Transmission rate: 100 MBit/s</li> <li>▶ IP address is set via DIP switch on the front of the unit</li> <li>▶ Connection to fieldbus via RJ45 connector</li> </ul>	772 137	783 542 (1 set)	793 542 (1 set)

Keep up-to-date  
on communication  
modules:

 Webcode 10525

Online information  
at [www.pilz.com](http://www.pilz.com)

## ► Configurable small control system PNOZmulti



Do you need to monitor more than three safety functions, comfortably with as few clicks as possible in one software tool? Then the configurable small control systems PNOZmulti Mini are the right solution for you. Irrespective of the operational control system, you will always have a one-stop safety solution, which can easily be adapted to changing requirements. Diagnostic and status information is transferred to the higher level control system using various communication modules. Play it safe and use PNOZmulti Mini – the worldwide safety standard for all machine types.



PNOZ mm0.1p

### Compact device – Stand-alone base unit

At a width of just 45 mm, the stand-alone base unit has 20 freely configurable safe inputs, 4 safe semiconductor outputs (PL e/SIL CL 3) and 4 test pulse outputs. The compact design saves space in the control cabinet. The integrated display offers simple diagnostics and the ability to display customized texts. Short commissioning times and simple wiring save costs.

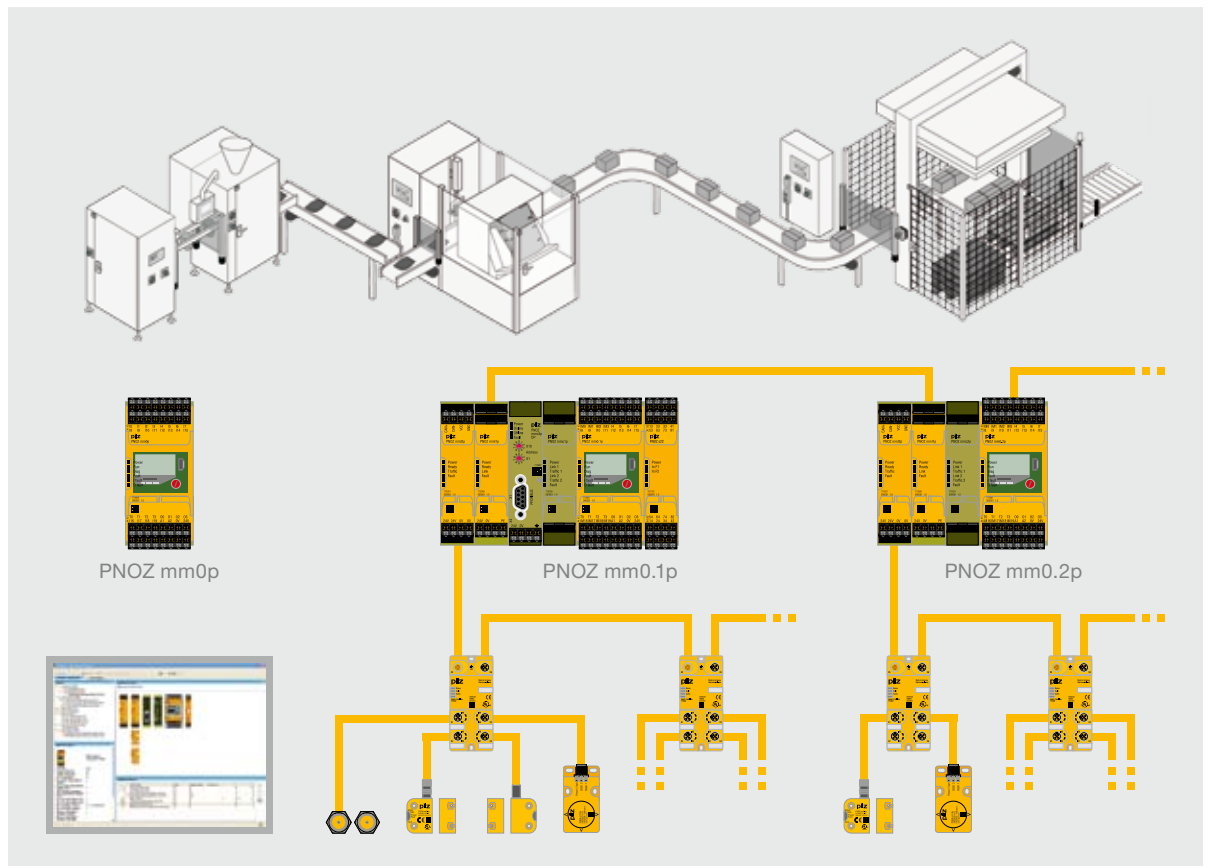

# Mini

## Genial device – Base unit is modular and expandable

The base unit PNOZ mm0.1p is ready to meet growing requirements. It has the same technical features as the PNOZ mm0p. The difference: it is modular and expandable. By selecting the appropriate modules and performing a simple configuration, you can expand your application easily and economically. Expand to the left using safe link and communication modules. Contact expansion modules from the PNOZsigma product range are available to multiply the relay contacts on the right-hand side.

## Communicative device – Base unit with Multi-Link inside

In addition to the functionality of the PNOZ mm0.1p, the base unit PNOZ mm0.2p also provides an integrated multi-link interface. This removes the need for an additional module, saving you costs. As a result, it is easy to link and exchange data between several base units PNOZmulti Mini and between PNOZmulti Mini and PNOZmulti 2.



Small control systems

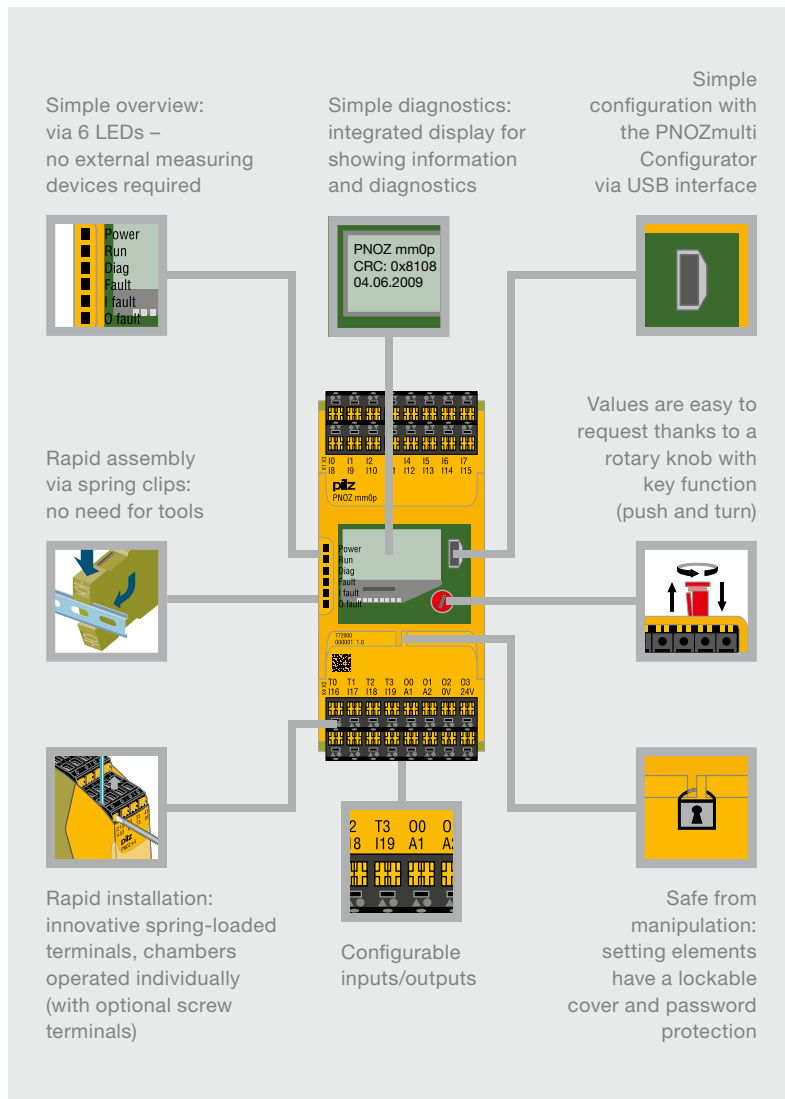

### Your benefits at a glance

- ▶ Efficient from three safety functions onwards
- ▶ The software tool PNOZmulti Configurator saves you time and costs in all engineering phases
- ▶ Maximum flexibility: Inputs and outputs are freely configurable
- ▶ Saves lots of space in the control cabinet due to the compact design
- ▶ Reduced downtimes thanks to PVIS support
- ▶ Customer texts can be displayed
- ▶ Worldwide safety standard for all machine types

Keep up-to-date on the configurable small control systems PNOZmulti Mini:



Webcode 10517

Online information at [www.pilz.com](http://www.pilz.com)

## ► Technical details – PNOZmulti Mini

### PNOZmulti Mini – Base units

**Common features:**

- ▶ Configurable using PNOZmulti Configurator via chip card or USB interface
- ▶ Exchangeable program memory
- ▶ 20 inputs, up to 8 of which can be configured as auxiliary outputs.
- ▶ 4 safe semiconductor outputs (PL e, SIL CL 3)
- ▶ 4 test pulse outputs, up to 4 of which can be configured as standard outputs
- ▶ Supply voltage (U<sub>B</sub>): 24 VDC
- ▶ Voltage/current/rating: 24 VDC/2 A/48 W, outputs using semiconductor technology
- ▶ With display for error messages, state of the supply voltage, state of the inputs and outputs, status and device information. Customized texts can be displayed
- ▶ Rotary knob for menu control
- ▶ Dimensions (H x W x D): 100/98<sup>1)</sup> x 45 x 120 mm



PNOZ mm0p



PNOZ mm0.1p



PNOZ mm0.2p

Type	Application area
PNOZ mm0p PNOZ mm0p-T <sup>2)</sup>	Base unit – Non-modular and expandable, from 3 ... 6 safety functions
PNOZ mm0.1p	Base unit – Modular and expandable, from 4 safety functions and for standard control functions
PNOZ mm0.2p	Base unit – As PNOZ mm0.1p, with an additional integrated multi-link interface

### PNOZmulti Mini – I/O modules

**Common features:**

- ▶ Can be configured using the PNOZmulti Configurator
- ▶ Can be connected to the left of the base unit



PNOZ mml1p





PNOZ mml2p

Type	Application area
PNOZ mml1p Multi-Link	Safe link module Multi-Link
PNOZ mml2p PDP	Safe link module PDP67 to connect a base unit to up to 4 decentralized modules PDP67
PDP67 F 8DI ION PDP67 F 8DI ION HP	Decentralized input modules

Features	Order number		
	Excl. terminals	Push-in spring terminals	Plug-in screw terminals
Application range: to connect emergency stop pushbuttons, two-hand buttons, safety gate limit switches, light beam devices, scanners, enable switches, safety gate switches PSEN, operating mode selector switches, muting, safety mats, sensors	<ul style="list-style-type: none"> <li>▶ PNOZ mm0p ____ 772 000</li> <li>▶ PNOZ mm0p-T _ 772 010</li> </ul> Mini USB cable <ul style="list-style-type: none"> <li>▶ 3 m _____ 312 992</li> <li>▶ 5 m _____ 312 993</li> </ul> <ul style="list-style-type: none"> <li>▶ Chip card 8 kByte 1 piece _____ 779 201</li> <li>▶ Chip card 32 kByte 1 piece _____ 779 211</li> </ul>	751 008 (1 set)	750 008 (1 set)
<ul style="list-style-type: none"> <li>▶ As PNOZ mm0p</li> <li>▶ Expandable to the left using the link modules PNOZ mm11p Multi-Link, PNOZ mm12p PDP and a communication module PNOZ mmc1p ETH or PNOZ mmc2p serial. A fieldbus module may also be connected</li> <li>▶ Expandable to the right using a contact expansion module PNOZsigma: PNOZ s22 or s7, s7.1, s7.2, s10, s11</li> <li>▶ Decentralization: PDP67 modules to connect sensor technology</li> <li>▶ PVIS support</li> </ul>	772 001	751 008 (1 set)	750 008 (1 set)
	772 002	751 008 (1 set)	750 008 (1 set)

Features	Order number		
	Excl. terminals	Push-in spring terminals	Plug-in screw terminals
<ul style="list-style-type: none"> <li>▶ Link module to safely connect base units PNOZmulti Mini, PNOZmulti and PNOZmulti 2</li> <li>▶ Point-to-point connection via 4-core shielded and twisted-pair cable</li> <li>▶ 32 virtual inputs and 32 virtual outputs</li> <li>▶ Max. four PNOZ mm11p units can be connected to the left of the base unit</li> <li>▶ Dimensions (H x W x D) in mm: 100 x 22.5 x 120</li> </ul>	772 020	783 538 (1 set)	793 538 (1 set)
<ul style="list-style-type: none"> <li>▶ Ability to connect up to four expansion modules to the left of the base unit PNOZ mm0.1p or mm0.2p</li> <li>▶ Max. four decentralized input modules PDP67 can be connected to an expansion module (16 sensors with a maximum configuration)</li> <li>▶ Dimensions (H x W x D) in mm: 98/100<sup>1)</sup> x 22.5 x 120</li> </ul>	772 021	783 540 (1 set)	793 540 (1 set)
<ul style="list-style-type: none"> <li>▶ For information please refer to pages 88/89</li> </ul>	-	-	-

Keep up-to-date on:  
 ▶ Base units  
 PNOZmulti Mini  
 Webcode 10519

▶ I/O modules  
 PNOZmulti Mini  
 Webcode 10520

Online information at [www.pilz.com](http://www.pilz.com)

<sup>1)</sup> Height with spring-loaded terminals / plug-in screw terminals

<sup>2)</sup>  Extended temperature range

## ► Technical details – PNOZmulti Mini

### PNOZmulti Mini – Communication modules



Ethernet

PNOZ mmc1p ETH



RS232

PNOZ mmc2p serial



PNOZ mmc3p DP



PNOZ mmc4p DN



PNOZ mmc6p CAN



PNOZ mmc7p CC



PNOZ mmc11p CAT

Type	Application area
PNOZ mmc1p ETH	Communication module, subscriber on Ethernet TCP/IP and Modbus TCP (Slave)
PNOZ mmc2p serial	Communication module with serial interface RS232
PNOZ mmc3p DP	Fieldbus module PROFIBUS-DP (Slave DPVO)
PNOZ mmc4p DN	Fieldbus module DeviceNet (Slave)
PNOZ mmc6p CAN	Fieldbus module CANopen (Slave)
PNOZ mmc7p CC	Fieldbus module CC-Link (Slave v1.10)
PNOZ mmc11p CAT	Fieldbus module EtherCAT (Slave)

**Common features:**

- Can be configured using the PNOZmulti Configurator
- Can be connected to the left of the base unit



Features	Order number		
	Excl. terminals	Push-in spring terminals	Plug-in screw terminals
<ul style="list-style-type: none"> <li>▶ 2 Ethernet interfaces</li> <li>▶ Transmission rate 10 MBit/s</li> <li>▶ Status indicators via LEDs</li> <li>▶ Max. 1 communication module can be connected to the left of the base unit; a fieldbus module can also be connected</li> <li>▶ Connected to base unit via a link on the back of the unit</li> <li>▶ Dimensions (H x W x D): 100 x 22.5 x 120 mm</li> </ul>	772 030	-	-
<ul style="list-style-type: none"> <li>▶ 1 serial interface RS232</li> <li>▶ Status indicators via LEDs</li> <li>▶ Max. 1 communication module can be connected to the left of the base unit; a fieldbus module can also be connected</li> <li>▶ Connected to base unit via a link on the back of the unit</li> <li>▶ Dimensions (H x W x D): 100 x 22.5 x 120 mm</li> </ul>	772 031	783 538 (1 set)	793 538 (1 set)
<ul style="list-style-type: none"> <li>▶ Station addresses from 0 ... 99, selected via rotary switch</li> <li>▶ Transmission rate: max. 12 MBit/s</li> <li>▶ Connection to fieldbus: via 9-pin female D-Sub connector</li> <li>▶ Dimensions (H x W x D) in mm: 100 x 22.5 x 115</li> </ul>	772 032	783 542 (1 set)	793 542 (1 set)
<ul style="list-style-type: none"> <li>▶ Station addresses from 0 ... 63, selected via DIP switch</li> <li>▶ Transmission rate: 500 kBit/s</li> <li>▶ Connection to fieldbus: via 5-pin Combicon plug-in connector</li> <li>▶ Dimensions (H x W x D) in mm: 100 x 22.5 x 110</li> </ul>	772 033	783 542 (1 set)	793 542 (1 set)
<ul style="list-style-type: none"> <li>▶ Station addresses from 0 ... 99, selected via rotary switch</li> <li>▶ Transmission rate: Max. 1 MBit/s</li> <li>▶ Transmission rate selected via rotary switch</li> <li>▶ Connection to fieldbus: via 9-pin female D-Sub connector</li> <li>▶ Dimensions (H x W x D) in mm: 100 x 22.5 x 115</li> </ul>	772 034	783 542 (1 set)	793 542 (1 set)
<ul style="list-style-type: none"> <li>▶ Transmission rate: Max. 10 MBit/s</li> <li>▶ Connection to fieldbus: via 5-pin Combicon plug-in connector</li> <li>▶ Dimensions (H x W x D) in mm: 100 x 22.5 x 110</li> </ul>	772 035	783 542 (1 set)	793 542 (1 set)
<ul style="list-style-type: none"> <li>▶ Transmission rate: Max. 100 MBit/s</li> <li>▶ Dimensions (H x W x D) in mm: 100 x 22.5 x 115</li> </ul>	772 036	783 542 (1 set)	793 542 (1 set)

Small control systems

Keep up-to-date  
on the communi-  
cation modules  
PNOZmulti Mini

 Webcode 10521

Online information  
at [www.pilz.com](http://www.pilz.com)

## ► Configurable safety system PNOZmulti



The configurable safety system PNOZmulti is ideal when several safety functions are to be implemented on a machine. Instead of wiring, you can simply configure your safety circuit on a PC. PNOZmulti is multifunctional, freely configurable and tailor-made for use in many areas of mechanical engineering.



PNOZ m1p ETH

The safety system PNOZmulti monitors safety functions such as E-STOP, safety gates, light beam devices, two-hand and many more. All safety functions are created with the software tool PNOZmulti Configurator. The hardware configuration with the selection of base unit and expansion modules can also be made easily via the PNOZmulti Configurator. So you can reduce your engineering times and get to market quicker. You can then save the completed configuration on to a chip card. From there it is transferred to the base unit.

### The right module for every requirement ...

If your plant expands, the PNOZmulti simply expands with it. Expansion modules are available to extend the modular system; these can be used in any combination to suit the requirement:

- Input and output modules, e.g. the safe analog input module
- Fieldbus modules
- Safe speed and standstill monitors
- Safe link modules for the safe interconnection of several PNOZmulti base units or the safe interconnection of decentralized periphery

All PNOZmulti base units have 20 inputs, 4 safe semiconductor outputs and 2 relay outputs. Versions are available with serial or ETH interface.



PNOZ ma1p

### Monitoring analog input signals safely

The safe analog input module PNOZ ma1p provides two independent, safe inputs. Up to eight limit values can be defined for each input with just a few clicks of the mouse in the PNOZmulti Configurator. The inputs are suitable for connecting transducers or encoders with standardized 10 V voltage signals or 20 mA current signals. As users you benefit from rapid commissioning and reduced wiring. With its analog input module, the PNOZmulti is particularly suitable for the process engineering sector, cable car and chair lift design and burner controls.

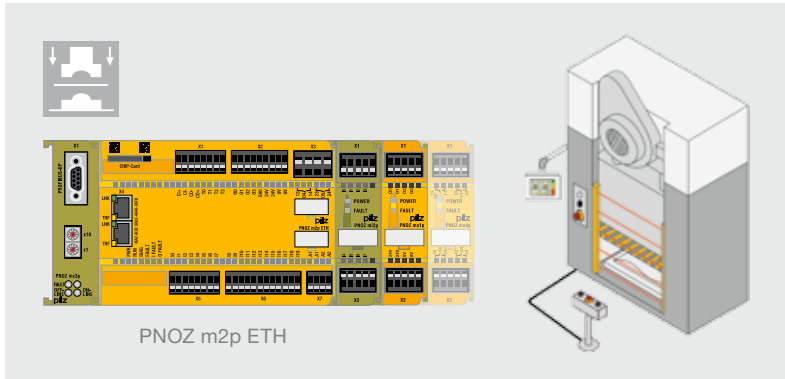

PNOZ m2p ETH

Specifically for press applications

**Use on presses**

The base unit PNOZ m2p is specially designed to control and monitor small and average-sized eccentric and hydraulic presses. Approved software blocks are available for operating modes such as set-up, single-stroke and automatic, and to monitor safety light curtains in single-break or double-break mode; these blocks make the system simple and economical to use.

In conjunction with the dual-pole semiconductor output module PNOZ mo3p, the PNOZ m2p can control press safety valves safely and economically.

**Your benefits at a glance**

- ▶ One system to cover safety-related and automation tasks
- ▶ Up to 40 % potential savings in all engineering phases thanks to a graphics configuration tool
- ▶ Variety of base units and modules for flexible, industry-wide applications
- ▶ Simple and economical to expand by selecting compatible modules
- ▶ Simple, user-friendly diagnostics mean short downtimes and high plant availability
- ▶ Certified worldwide



Small control systems

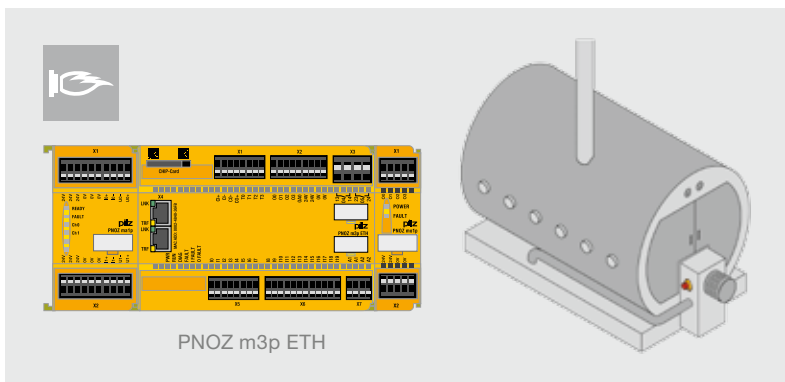

PNOZ m3p ETH

Specifically for burner management

**PNOZmulti in burner management**

PNOZ m3p controls and monitors furnaces, incl. safety chains. The safe ignition of the fuel and the monitoring of a furnace during operation are safety-related criteria that prevent an explosion with serious damages. With the base unit PNOZ m3p you have a safety-related solution to hand that fulfils these requirements.

Keep up-to-date on configurable safety systems PNOZmulti:

Webcode 5245

Online information at [www.pilz.com](http://www.pilz.com)

## ► Technical details – PNOZmulti

### PNOZmulti – Base units

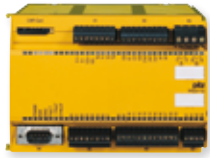

PNOZ m1p

Type	Application area
<b>PNOZ m0p, PNOZ m0p ETH</b>	Base unit – From 3 ... 6 safety functions  Only link modules and fieldbus modules can be connected, no other expansion modules can be used
<b>PNOZ m1p, PNOZ m1p ETH, PNOZ m1p coated version <sup>1)</sup>, PNOZ m1p ETH coated version <sup>1)</sup></b>	Base unit – from 4 safety functions and for automation functions
<b>PNOZ m2p, PNOZ m2p ETH</b>	Base unit – Specifically for press applications: Monitoring of operating modes such as setup, single-stroke and automatic, safety light curtains in single-break and double-break mode, camshaft with run monitoring, press safety valves
<b>PNOZ m3p, PNOZ m3p ETH</b>	Base unit – Specifically for burner management: Control and monitoring of furnaces, e.g. monitoring of safety chains, combustion air pressure, ignition, flame, external compound controller and tightness control; plus control of safety valves, ignition valves, exhaust valves, ignition, external compound controller and combustion air blower

### PNOZmulti – Input modules



PNOZ mi1p

Type	Application area	Inputs/outputs
<b>PNOZ mi1p PNOZ mi1p coated version <sup>1)</sup></b>	Safe input module	8 safe inputs
<b>PNOZ mi2p</b>	Input module	8 inputs for non-safety related functions

Features	Order number		
	Excl. terminals	Spring-loaded terminals	Plug-in screw terminals
<ul style="list-style-type: none"> <li>▶ Application range: to connect emergency stop pushbuttons, two-hand buttons, safety gate limit switches, light beam devices, scanners, enable switches, safety gate switches PSEN, operating mode selector switches, muting, safety mats, sensors</li> <li>▶ Configurable using PNOZmulti Configurator via chip card or RS 232 interface/Ethernet interface</li> <li>▶ Exchangeable program memory</li> <li>▶ Diagnostic interface</li> <li>▶ Max. 1 fieldbus module can be connected</li> <li>▶ PNOZ m1p/PNOZ m2p/PNOZ m3p: Max. 8 expansion modules can be connected</li> <li>▶ Inputs/outputs:                             <ul style="list-style-type: none"> <li>- 20 freely configurable inputs,</li> <li>4 test pulse outputs, 1 auxiliary output</li> <li>- Outputs using semiconductor technology: 4 safety outputs</li> <li>- Relay outputs: 2 safety contacts</li> </ul> </li> <li>▶ Supply voltage (U<sub>B</sub>): 24 VDC</li> <li>▶ Voltage/current/rating:                             <ul style="list-style-type: none"> <li>- Outputs using semiconductor technology: 24 VDC/2 A/48 W</li> <li>- Relay outputs: DC1: 24 V/6 A/144 W</li> </ul> </li> <li>▶ Dimensions (H x W x D): 94 x 135 x 121 mm</li> </ul>	<ul style="list-style-type: none"> <li>▶ PNOZ m0p _____ 773 110</li> <li>▶ PNOZ m0p ETH ____ 773 113</li> <li>▶ Chip card 8 kByte 1 piece _____ 779 201</li> <li>▶ Chip card 32 kByte 1 piece _____ 779 211</li> </ul>	783 100	793 100
	<ul style="list-style-type: none"> <li>▶ PNOZ m1p _____ 773 100</li> <li>▶ PNOZ m1p ETH ____ 773 103</li> <li>▶ PNOZ m1p coated version <sup>1)</sup> ____ 773 105</li> <li>▶ PNOZ m1p ETH coated version <sup>1)</sup> ____ 773 104</li> </ul>	783 100	793 100
	<ul style="list-style-type: none"> <li>▶ PNOZ m2p _____ 773 120</li> <li>▶ PNOZ m2p ETH ____ 773 123</li> </ul>	783 100	793 100
	<ul style="list-style-type: none"> <li>▶ PNOZ m3p _____ 773 125</li> <li>▶ PNOZ m3p ETH ____ 773 126</li> </ul>	783 100	793 100

Features	Order number		
	Excl. terminals	Spring-loaded terminals	Plug-in screw terminals
<ul style="list-style-type: none"> <li>▶ Max. 8 input modules can be connected to the base unit</li> <li>▶ Connected to base unit via a link on the back of the unit</li> </ul>	<ul style="list-style-type: none"> <li>▶ PNOZ mi1p _____ 773 400</li> <li>▶ PNOZ mi1p coated version <sup>1)</sup> ____ 773 405</li> </ul>	783 400 (1 set)	793 400 (1 set)
	773 410	783 400 (1 set)	793 400 (1 set)

Keep up-to-date on:

▶ Base units PNOZmulti

 Webcode 5548

▶ I/O modules PNOZmulti

 Webcode 5552

Online information at [www.pilz.com](http://www.pilz.com)

<sup>1)</sup>  Extended temperature range

## ► Technical details – PNOZmulti

### PNOZmulti – Input modules



PNOZ ma1p

Type	Application area	Inputs/outputs
PNOZ ma1p, PNOZ ma1p coated version <sup>1)</sup>	Safe analog input module	2 safe, analog inputs for voltage or current measurement (configurable)

### PNOZmulti – Output modules



PNOZ mo1p



PNOZ mc1p

Type	Application area	Inputs/outputs
PNOZ mo1p, PNOZ mo1p coated version <sup>1)</sup>	Safe semiconductor output module: switching 24 V actuators	Outputs using semiconductor technology: 4 safety outputs
PNOZ mo2p, PNOZ mo2p coated version <sup>1)</sup>	Safe relay output module: volt-free switching of actuators	Relay outputs: 2 safety outputs
PNOZ mo3p	Safe semiconductor output module, 2-pole	2-pole outputs using semiconductor technology: 2 safety outputs
PNOZ mo4p, PNOZ mo4p coated version <sup>1)</sup>	Safe relay output module: volt-free switching of actuators	Relay outputs: 4 safety outputs
PNOZ mo5p	Safe relay output module: to control the safety valves on a burner in accordance with EN 50156	Positive-guided relay outputs, diverse: 4 safety outputs
PNOZ mc1p, PNOZ mc1p coated version <sup>1)</sup>	Output module: Status message to PLC	16 auxiliary outputs using semiconductor technology

#### Common features

- Connected to base unit via a link on the back of the unit
- Dimensions (H x W x D) in mm: 94 x 22.5 x 121, PNOZ mc1p: 94 x 45 x 121

Features	Order number		
	Excl. terminals	Spring-loaded terminals	Plug-in screw terminals
<ul style="list-style-type: none"> <li>▶ Range monitoring (4 range limits can be configured)</li> <li>▶ Threshold value monitoring (8 limit values can be configured)</li> <li>▶ Voltage range: -10.24 ... +10.2375 V</li> <li>▶ Current range: 0 ... 25.59 mA</li> <li>▶ Can be connected to the left of the base unit</li> <li>▶ Max. 4 PNOZ ma1p units can be connected to the base unit</li> <li>▶ Status indicators</li> <li>▶ Dimensions (H x W x D) in mm: 94 x 45 x 121</li> </ul>	<ul style="list-style-type: none"> <li>▶ PNOZ ma1p _____ 773812</li> <li>▶ PNOZ ma1p coated version <sup>1)</sup> ___ 773813</li> </ul>	783 700 (1 set)	793 700 (1 set)

Outputs: Voltage/current/ rating	Features	Order number Excl. terminals	Spring-loaded terminals	Plug-in screw terminals
24 VDC/2 A/48 W	▶ Max. 6 output modules can be connected to the right of the base unit	▶ PNOZ mo1p _____ 773500	783 400 (1 set)	793 400 (1 set)
DC1: 24 V/6 A		▶ PNOZ mo1p coated version <sup>1)</sup> ___ 773505		
24 VDC/2 A		▶ PNOZ mo2p _____ 773520	783 520 (1 set)	793 520 (1 set)
DC1: 24 V/6 A		▶ PNOZ mo2p coated version <sup>1)</sup> ___ 773525		
24 VDC/2 A		▶ 773 510	783 400 (1 set)	793 400 (1 set)
DC1: 24 V/6 A	▶ Max. 8 output modules can be connected to the right of the base unit	▶ PNOZ mo4p _____ 773536	783 536 (1 set)	793 536 (1 set)
DC1: 24 V/6 A/144 W		▶ PNOZ mo4p coated version <sup>1)</sup> ___ 773537		
-		▶ 773 534	783 536 (1 set)	793 536 (1 set)
-		▶ PNOZ mc1p _____ 773 700	783 700 (1 set)	793 700 (1 set)
		▶ PNOZ mc1p coated version <sup>1)</sup> ___ 773 705		

<sup>1)</sup>  Extended temperature range

Keep up-to-date on I/O modules PNOZmulti

 Webcode 5552

Online information at [www.pilz.com](http://www.pilz.com)

## ► Technical details – PNOZmulti

### PNOZmulti – Safe speed and standstill monitors

#### Common features

- Application range: The expansion modules monitor drives for standstill, speed and direction of rotation in set-up and automatic mode in accordance with EN ISO 13849-1 up to PL e and EN IEC 62061 up to SIL CL 3
- Incremental encoders are connected via connection cable
- Max. 4 speed monitors can be connected to the base unit
- Measured variables: standstill, speed, direction of rotation
- Axis types and reset mode can be selected in the PNOZmulti Configurator
- Dimensions (H x W x D) in mm: 94 x 45 x 121



PNOZ ms1p



PNOZ ms4p

Type	Connectable encoders
PNOZ ms1p	Proximity switch, incremental encoder Sin/Cos, TTL (5 V)
PNOZ ms2p	Proximity switch, incremental encoder Sin/Cos, TTL (5 V), HTL (24 V)
PNOZ ms2p HTL	Proximity switch, incremental encoder HTL
PNOZ ms2p TTL, PNOZ ms2p TTL coated version <sup>1)</sup>	Proximity switch, incremental encoder Sin/Cos, TTL (5 V)
PNOZ ms3p	Incremental encoder Sin/Cos, TTL (5 V), HTL (24 V)
PNOZ ms3p HTL	Incremental encoder HTL (24 V)
PNOZ ms3p TTL	Incremental encoder Sin/Cos, TTL (5 V)
PNOZ ms4p	Incremental encoder Sin/Cos, TTL (5 V), HTL (24 V)

### PNOZmulti – Link modules

#### Common features

- Can be configured in the PNOZmulti Configurator
- Dimensions (H x W x D) in mm: 94 x 22.5 x 121



PNOZ ml1p

Type	Application area
PNOZ ml1p, PNOZ ml1p coated version	To safely connect two PNOZmulti base units; tree or ring structure possible
PNOZ ml2p	To safely connect a base unit to up to 4 decentralized modules PDP



Features	Order number		
	Excl. terminals	Spring-loaded terminals	Plug-in screw terminals
<ul style="list-style-type: none"> <li>▶ Monitoring of 2 independent axes (8 limit frequencies can be selected)</li> <li>▶ Connection per axis: 1 incremental encoder or 2 proximity switches or one of each</li> <li>▶ Encoder types can be selected in the PNOZmulti Configurator</li> <li>▶ Proximity detectors are connected directly to the terminals</li> </ul>	773 800	783 800 (1 set)	793 800 (1 set)
	773 810		
<ul style="list-style-type: none"> <li>▶ Incremental encoder with differential output signals from 12 Vss to 30 Vss, i.e. now also suitable for HTL encoders</li> <li>▶ Independent from the supply voltage of the incremental encoder, i.e. also for encoders with 8 V supply voltage, for example</li> </ul>	773 815		
-	<ul style="list-style-type: none"> <li>▶ PNOZ ms2p TTL ___ 773 816</li> <li>▶ PNOZ ms2p TTL coated version <sup>1)</sup> ___ 773 811</li> </ul>		
-	773 820		
<ul style="list-style-type: none"> <li>▶ Monitoring of 2 independent axes (8 limit frequencies can be selected)</li> <li>▶ Connection per axis: 1 incremental encoder with differential output signals from 12 Vss to 30 Vss</li> </ul>	773 825		
<ul style="list-style-type: none"> <li>▶ Monitoring of 2 independent axes (8 limit frequencies can be selected)</li> <li>▶ Connection per axis: 1 incremental encoder 0.5 Vss to 5 Vss</li> </ul>	773 826		
<ul style="list-style-type: none"> <li>▶ Monitoring of 1 axis (16 limit frequencies can be selected)</li> <li>▶ Connection per axis: 1 incremental encoder 0.5 Vss to 30 Vss</li> </ul>	773 830		

Features	Order number		
	Excl. terminals	Spring-loaded terminals	Plug-in screw terminals
<ul style="list-style-type: none"> <li>▶ Point-to-point connection via 4-core shielded and twisted-pair cable</li> <li>▶ Transfer of 32 bit input data and 32 bit output data (virtual I/Os)</li> <li>▶ Max. 4 PNOZ m11p units can be connected to the base unit</li> </ul>	<ul style="list-style-type: none"> <li>▶ PNOZ m11p _____ 773 540</li> <li>▶ PNOZ m11p coated version <sup>1)</sup> ___ 773 545</li> </ul>	783 400 (1 set)	793 400 (1 set)
<ul style="list-style-type: none"> <li>▶ Max. 4 PNOZ m12p can be connected to the base unit</li> <li>▶ Max. 4 decentralized modules PDP67 F 8DI ION can be connected to the link module PNOZ m12p</li> </ul>	773 602		

Keep up-to-date on I/O modules PNOZmulti

 Webcode 5552

Online information at [www.pilz.com](http://www.pilz.com)

<sup>1)</sup>  Extended temperature range

## ► Technical details – PNOZmulti

### Fieldbus modules – PNOZmulti communication modules



PNOZ mc2.1p



PNOZ mc3p



PNOZ mc4p

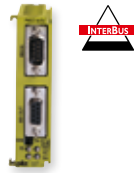

PNOZ mc5p



PNOZ mc5.1p



PNOZ mc6p



PNOZ mc7p



PNOZ mc8p



PNOZ mc9p



PNOZ mc10p

Type	Application area
PNOZ mc2p, PNOZ mc2.1p	Fieldbus modules EtherCAT Subscriber (Slave), supports CANopen over EtherCAT
PNOZ mc3p	Fieldbus module PROFIBUS-DP Subscriber (Slave)
PNOZ mc4p, PNOZ mc4p coated version <sup>1)</sup>	Fieldbus module DeviceNet Subscriber (Slave)
PNOZ mc5p	Fieldbus module Interbus Subscriber (Slave)
PNOZ mc5.1p	Fieldbus module Interbus fiber-optic cable (FO) Subscriber (Slave)
PNOZ mc0p Power supply	Power supply for Interbus fieldbus modules PNOZ mc5p/PNOZ mc5.1p
PNOZ mc6p, PNOZ mc6p coated version <sup>1)</sup> , PNOZ mc6.1p	Fieldbus modules CANopen Subscriber (Slave)
PNOZ mc7p, PNOZ mc7p coated version <sup>1)</sup>	Fieldbus module CC-Link Subscriber (Slave)
PNOZ mc8p, PNOZ mc8p coated version <sup>1)</sup>	Fieldbus Module Subscriber on EtherNet IP / Modbus TCP (Slave)
PNOZ mc9p	Fieldbus module Subscriber on PROFINET
PNOZ mc10p	Fieldbus module Sercos III Subscriber (Slave)

#### Common features

- Can be configured in the PNOZmulti Configurator
- Data can be used for visualization/diagnostics or for control
- Status indicators via LEDs
- Max. 1 fieldbus module can be connected to the base unit
- Connection to the base unit using jumpers on the back of the unit

Dimensions (H x W x D) in mm	Features	Order number
94 x 22.5 x 114	<ul style="list-style-type: none"> <li>▶ Transmission rate: Max. 100 MBit/s</li> <li>▶ Connection to fieldbus via RJ45 connector</li> </ul>	<ul style="list-style-type: none"> <li>▶ PNOZ mc2p _____ 773 710</li> <li>▶ PNOZ mc2.1p _____ 773 713</li> </ul>
94 x 22.5 x 119	<ul style="list-style-type: none"> <li>▶ Station addresses from 0 ... 99, selected via rotary switch</li> <li>▶ Transmission rate: Max. 12 MBit/s</li> <li>▶ Connection: Female 9-pin D-Sub connector</li> </ul>	773 732
94 x 22.5 x 122	<ul style="list-style-type: none"> <li>▶ Station addresses from 0 ... 63, selected via DIP switch</li> <li>▶ Transmission rate: 125, 250, 500 kBit/s</li> <li>▶ Connection to fieldbus via 5-pin Combicon plug-in connector</li> </ul>	<ul style="list-style-type: none"> <li>▶ PNOZ mc4p _____ 773 711</li> <li>▶ PNOZ mc4p coated version<sup>1)</sup> _____ 773 729</li> </ul>
94 x 22.5 x 119	<ul style="list-style-type: none"> <li>▶ Transmission rate: 500 kBit/s, 2 MBit/s, selected via jumper</li> <li>▶ Connection to IBS IN via male 9-pin D-Sub connector, to IBS OUT via female 9-pin D-Sub connector</li> </ul>	773 723
94 x 22.5 x 121	<ul style="list-style-type: none"> <li>▶ Transmission rate: 500 kBit/s, 2 MBit/s, selected via jumper</li> <li>▶ Status indicators for communication with Interbus and for errors</li> <li>▶ Connection to fieldbus via F-SMA connector</li> </ul>	773 728
94 x 22.5 x 121	<ul style="list-style-type: none"> <li>▶ Interface to connect the base unit and a fieldbus module</li> <li>▶ Galvanic isolation</li> <li>▶ Status indicators</li> <li>▶ Plug-in terminals (either with cage clamp terminals or screw connection)</li> </ul>	<ul style="list-style-type: none"> <li>▶ PNOZ mc0p Power supply _____ 773 720</li> <li>▶ Spring-loaded terminals (1 set) _____ 783 400</li> <li>▶ Plug-in screw terminals (1 set) _____ 793 400</li> </ul>
94 x 22.5 x 119	<ul style="list-style-type: none"> <li>▶ Station addresses from 0 ... 99, selected via rotary switch</li> <li>▶ Transmission rate: max. 1 MBit/s, selected via rotary switch</li> <li>▶ Supported protocols:                             <ul style="list-style-type: none"> <li>- PNOZ mc6p: CiA DS-301 V3.0</li> <li>- PNOZ mc6.1p: CiA DS-301 V4.0.2</li> </ul> </li> <li>▶ Connection to fieldbus via male 9-pin D-Sub connector</li> </ul>	<ul style="list-style-type: none"> <li>▶ PNOZ mc6p _____ 773 712</li> <li>▶ PNOZ mc6p coated version<sup>1)</sup> _____ 773 727</li> <li>▶ PNOZ mc6.1p _____ 773 733</li> </ul>
94 x 22.5 x 122	<ul style="list-style-type: none"> <li>▶ Station addresses from 0 ... 63, selected via rotary switch</li> <li>▶ Occupied stations: 2</li> <li>▶ Transmission rate: max. 10 MBit/s, selected via rotary switch</li> <li>▶ Connection: 5-pin Combicon plug-in connector</li> </ul>	<ul style="list-style-type: none"> <li>▶ PNOZ mc7p _____ 773 726</li> <li>▶ PNOZ mc7p coated version<sup>1)</sup> _____ 773 725</li> </ul>
94 x 22.5 x 114	<ul style="list-style-type: none"> <li>▶ Transmission rate: Max. 10 MBit/s</li> <li>▶ IP address is set via DIP switches on the front of the unit</li> <li>▶ Connection to fieldbus via RJ45 connector</li> </ul>	<ul style="list-style-type: none"> <li>▶ PNOZ mc8p _____ 773 730</li> <li>▶ PNOZ mc8p coated version<sup>1)</sup> _____ 773 734</li> </ul>
94 x 22.5 x 114	<ul style="list-style-type: none"> <li>▶ Device name can be configured in the PNOZmulti Configurator</li> <li>▶ Diagnostics and alarm function are not supported</li> <li>▶ Transmission rate: 100 MBit/s</li> <li>▶ Connection to fieldbus via RJ45 connector</li> </ul>	773 731
94 x 22.5 x 114	<ul style="list-style-type: none"> <li>▶ Transmission rate: Max. 100 MBit/s</li> <li>▶ Connection to fieldbus via RJ45 connector</li> </ul>	773 715

<sup>1)</sup>  Extended temperature range

Keep up-to-date on the communication modules PNOZmulti:

 Webcode 5553

Online information at [www.pilz.com](http://www.pilz.com)

## ► Technical details – PNOZmulti Configurator

### Software tool – PNOZmulti Configurator



Type	Features
PNOZmulti Configurator	<ul style="list-style-type: none"> <li>▶ Graphic tool for configuration and programming of the configurable control systems PNOZmulti</li> <li>▶ Project configuration, configuration generation, documentation, commissioning</li> <li>▶ Data transfer via serial interface or chip card</li> <li>▶ User interface in German, English, French, Italian, Spanish, Japanese, Chinese (selectable)</li> <li>▶ System requirements (from Version 8.0.0):                             <ul style="list-style-type: none"> <li>- Operating system: Windows® XP/Server 2003/Vista</li> <li>- Standard PC with min. 1 GHz processor</li> <li>- RAM: min. 1 024 MByte</li> <li>- Hard drive: 20 GByte, min. 15 GByte of available disk space</li> <li>- Supports Super VGA graphics</li> <li>- DVD drive</li> </ul> </li> <li>▶ In order to use the full scope of the PNOZmulti Configurator, you will need a valid licence in addition to the software package. Without a licence, the PNOZmulti Configurator can only be used in a demo version. A range of licences are available to meet varying requirements.</li> <li>▶ Licence types are available as a full version or service version.                             <ul style="list-style-type: none"> <li>- Full version: The full version provides the whole functional range of a licence.</li> <li>- Service version: The service version of a licence is intended for service and maintenance. The service version offers only limited editing features.</li> </ul> </li> </ul>

### PNOZmulti Tool Kit



Type	Features
PNOZmulti Tool Kit	<ul style="list-style-type: none"> <li>▶ The Tool Kit comes in a carry case and contains the accessories you need to start working with PNOZmulti:                             <ul style="list-style-type: none"> <li>- Documentation folder with the PNOZmulti Configurator Software and Manual</li> <li>- Chip card reader to write and save the configuration on to a chip card</li> <li>- Chip card set consisting of 10 chip cards, including a chip card adapter for rewriting chips removed from the chip card</li> <li>- Configuration cable for reading diagnostic data (5 m)</li> <li>- Mounting bracket</li> </ul> </li> </ul>



Licence type	Order number		
	Type	Full version	Service version
<ul style="list-style-type: none"> <li>▶ <b>Basic Licence:</b> Single user licence, issued to one owner (company name and location/project must be stated)</li> <li>▶ <b>User Licence:</b> Discounted licence for an additional workstation, issued to the owner of a basic licence</li> <li>▶ <b>Lite Licence:</b> Licence limited to the base units PNOZ m0p and the base units PNOZmulti Mini, for use on one workstation</li> <li>▶ <b>Multi User Licence:</b> Multi user licence, graduated according to the number of workstations (up to 25, 50, 100 and over 100)</li> <li>▶ <b>Project Licence:</b> Licence to use the software within a contractually limited framework</li> <li>▶ <b>Basic/User/Multi User/Project Upgrade Licence:</b> Discounted licence enabling owners of a licence to change to a newer version of the software</li> <li>▶ <b>Time Limited Licence:</b> Basic licence restricted to 2, 3 or 4 months</li> </ul>	<ul style="list-style-type: none"> <li>▶ DVD and documentation folder <sup>1)</sup> ___ 773000D</li> <li>▶ DVD <sup>1)</sup> _____ 773000D</li> <li>▶ Basic Licence</li> <li>▶ User Licence</li> <li>▶ Lite Licence</li> <li>▶ Multi User Licence</li> <li>▶ Project Licence</li> <li>▶ Time Limited Licence, 2 months</li> <li>▶ Time Limited Licence, 3 months</li> <li>▶ Time Limited Licence, 4 months</li> <li><b>Upgrade</b></li> <li>▶ Basic Upgrade Licence</li> <li>▶ User Upgrade Licence</li> <li>▶ Multi User Upgrade Licence</li> <li>▶ Project Upgrade Licence</li> </ul>	   773010B 773010K 773010L 773010M 773010G 773010S 773010R 773010Q  773010U 773010V 773010N 773010W	   773011B 773011K 773011L 773011M 773011G - - -  773011U 773011V 773011N 773011W

Keep up-to-date on the software tool PNOZmulti Configurator:

Webcode 8633

Online information at [www.pilz.com](http://www.pilz.com)

Small control systems

<sup>1)</sup>Please order licence separately; this is required in order to activate the software; other licence types available on request

Order number					
PNOZmulti Tool Kit	Chip card reader	Chip cards	Configuration cable	Documentation folder with PNOZmulti Configurator	Licence type
779000	779230 <sup>2)</sup>	<ul style="list-style-type: none"> <li>▶ 8 kByte (1 piece) ___ 779201<sup>2)</sup></li> <li>▶ 8 kByte (10 piece) ___ 779200<sup>2)</sup></li> <li>▶ 32 kByte (1 piece) ___ 779211<sup>2)</sup></li> <li>▶ 32 kByte (10 piece) ___ 779212<sup>2)</sup></li> </ul>	310300 <sup>2)</sup>	773000  Please order licence separately	773010...  see PNOZmulti Configurator

<sup>2)</sup>For use only with subsequent orders

## ► Accessories – PNOZmulti

### Accessories – Configurable control system PNOZmulti



Chipcard



PSEN ma adapter



PNOZ msi1AP



MM A MINI-IO-CAB

Type	Application area
Chipcard	Chip card
Chipcard Holder	Chip card holder
Chip Card Reader	Chip card reader
PNOZmulti Seal	Labels for chip card
SafetyNET p Cable	Connection cable for all link modules PNOZmulti 2, PNOZmulti Mini and PNOZmulti
SafetyNET p Connector RJ45s	Plug-in connector
PNOZ mli1p	Connection cable for the PNOZ mli1p
PSEN ma adapter	Adapter for connection to safety switch PSENmag
PSEN cs adapter	Adapter for connection to safety switch PSENcode
PNOZ msi1Ap Adapter Si/Ha 25/25	Connection cable for PNOZ ms1p/PNOZ ms2p/PNOZ ms3p to connect incremental encoders
PNOZ msi1Bp Adapter Si/Ha 25/25	
PNOZ msi3Ap Adapter Si/Ha 15/15	
PNOZ msi3Bp Adapter Si/Ha 15/15	
PNOZ msi5p Adapter Bos/Rex 15/15	
PNOZ msi6p Adapter Elau 9/9	
PNOZ msi7p Adapter SEW 15/15	
PNOZ msi8p Adapter Lenze 9/9	
PNOZ msi9p adapter cable	
PNOZ msi19p ADAPTER ELAU PACDrive3	
PNOZ msi S09	-
PNOZ msi S15	-
PNOZ msi S25	-
MM A MINI-IO-CAB	Adapter cable for PNOZmulti 2, PNOZ m EF 1MM and PNOZ m EF 2MM

Features	Order number	Spring-loaded terminals	Plug-in screw terminals	
-	<ul style="list-style-type: none"> <li>▶ 8 kByte, 1 piece ____ 779201</li> <li>▶ 8 kByte, 10 pieces ____ 779200</li> <li>▶ 32 kByte, 1 piece ____ 779211</li> <li>▶ 32 kByte, 10 pieces ____ 779212</li> </ul>	-	-	
-	779240	-	-	
-	779230	-	-	
12 pieces	779250	-	-	
1 ... 500 m	380000	-	-	
-	380400	-	-	
<ul style="list-style-type: none"> <li>▶ Ready-made as spring-loaded or screw terminal type</li> <li>▶ Shielded</li> </ul>	-	<ul style="list-style-type: none"> <li>▶ 5 m ____ 773893</li> <li>▶ 10 m ____ 773894</li> <li>▶ 50 m ____ 773895</li> </ul>	<ul style="list-style-type: none"> <li>▶ 5 m ____ 773890</li> <li>▶ 10 m ____ 773891</li> <li>▶ 50 m ____ 773892</li> </ul>	
-	380300	-	-	
-	380301	-	-	
<ul style="list-style-type: none"> <li>▶ Used to connect an incremental encoder to the speed monitors PNOZ ms1p/PNOZ ms2p/PNOZ ms3p</li> <li>▶ Connection cable for all common makes of drive</li> <li>▶ Connection to drive and incremental encoder via 25-pin or 15-pin D-Sub male and female connector, or wired with stranded cable</li> </ul>	<ul style="list-style-type: none"> <li>▶ 2.5 m ____ 773840</li> <li>▶ 5 m ____ 773844</li> </ul>	-	-	
	<ul style="list-style-type: none"> <li>▶ 2.5 m ____ 773841</li> <li>▶ 5 m ____ 773839</li> </ul>	-	-	
	<ul style="list-style-type: none"> <li>▶ 2.5 m ____ 773842</li> </ul>	-	-	
	<ul style="list-style-type: none"> <li>▶ 2.5 m ____ 773843</li> </ul>	-	-	
	<ul style="list-style-type: none"> <li>▶ 2.5 m ____ 773857</li> <li>▶ 1.5 m ____ 773858</li> </ul>	-	-	
	<ul style="list-style-type: none"> <li>▶ 7.5 m ____ 773859</li> <li>▶ 2.5 m ____ 773860</li> <li>▶ 1.5 m ____ 773861</li> </ul>	-	-	
	<ul style="list-style-type: none"> <li>▶ 2.5 m ____ 773864</li> <li>▶ 1.5 m ____ 773865</li> </ul>	-	-	
	<ul style="list-style-type: none"> <li>▶ 2.5 m ____ 773862</li> <li>▶ 1.5 m ____ 773863</li> </ul>	-	-	
	<ul style="list-style-type: none"> <li>▶ 5.0 m ____ 773856</li> <li>▶ 2.5 m ____ 773854</li> <li>▶ 1.5 m ____ 773855</li> </ul>	-	-	
	<ul style="list-style-type: none"> <li>▶ 2.5 m ____ 773847</li> <li>▶ 1.5 m ____ 773846</li> </ul>	-	-	
	9-pin adapter, connector set	773870	-	-
	15-pin adapter, connector set	773871	-	-
	25-pin adapter, connector set	773872	-	-
	<ul style="list-style-type: none"> <li>▶ Shielded</li> <li>▶ One-side pre-assembled with 8-pin Mini-IO connector</li> </ul>	<ul style="list-style-type: none"> <li>▶ 1.5 m ____ 772200</li> <li>▶ 2.5 m ____ 772201</li> <li>▶ 5.0 m ____ 772202</li> </ul>		

Small control systems

Technical documentation on the configurable control systems PNOZmulti:

 Webcode 0685

Online information at [www.pilz.com](http://www.pilz.com)

## ▶ Decentralized modules PDP67 and PDP20

With the PDP67 modules you can achieve a high level of decentralization. The digital input module PDP67 F 8DI ION forwards the signals from decentralized sensors in the field to various evaluation devices, such as PNOZmulti 2, PNOZmulti Mini and PNOZmulti. Up to 64 sensors can be connected.



PDP67 F 8DI ION

### Decentralized and passive – decentralized safety

The passive junction PDP67 F 4 code enables the connection of up to four sensors PSEnlock or PSEnini. As well as the ability to connect to the configurable control systems PNOZmulti, PNOZmulti Mini and PNOZmulti 2, the safety relays PNOZsigma are also available.

Versatile automation architectures are possible due to the ability to connect various evaluation devices.

### PDP67 – Economical and safe

Integrated in dirt and water-repellent IP67 housings, the PDP67 modules can even be used where there are high demands on hygiene. The decentralized modules optimize the installation and wiring effort – saving you time, money and space in the control cabinet. PDP67 modules with stainless steel threads satisfy the requirements of the food industry.

### Type code for decentralized modules PDP67

#### PDP67 F 8DI ION HP VA

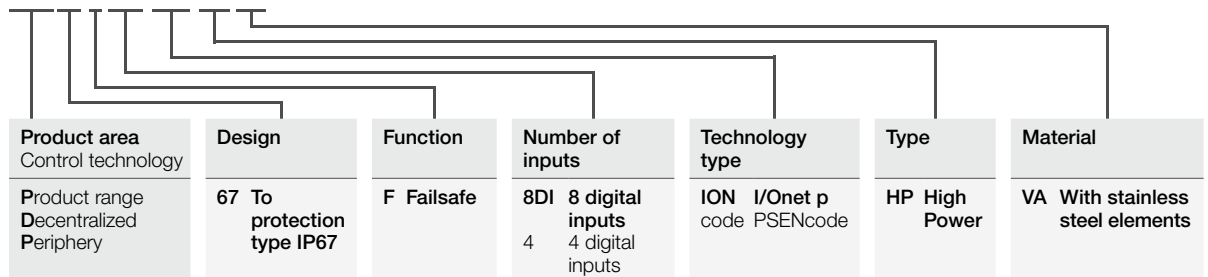

Keep up-to-date  
on decentralized  
modules: PDP67

 Webcode 6557

PDP20

 Webcode 8459

Online information  
at [www.pilz.com](http://www.pilz.com)





PDP20

**PDP20 – Series connection up to PL e**

The interface module PDP20 F 4 mag is ideally suitable for series connection of contact-based sensors, with N/O / N/O contacts such as PSENmag, up to PL e. As such it provides a standard-compliant solution in accordance with EN ISO 13849-1. The interface module can be connected to dual-channel evaluation devices (e.g. PNOZsigma, PNOZmulti, PSS, ...). Up to four sensors can be connected to each PDP20 module.

It is also possible to cascade the PDP20 modules. In this case each cascaded module will provide another three sensor interfaces.

**Your benefits at a glance**

- ▶ Simple installation means less planning, design and installation work
- ▶ Easy to implement a modular machine concept
- ▶ Just one cable for communication and supply, plug and play via M12 plug-in connector
- ▶ Simple diagnostics due to a point-to-point connection between the modules (each module can be identified)
- ▶ Individual sensors can be diagnosed on the modules



Small control systems

**Selection guide – Modules for alternative connection options for sensors**



PDP67 F 4 code



PDP67 Connector cs



PDP20 F 4 mag

Type	Features	Safety	Order number
<b>PDP67 F 8DI ION, PDP67 F 8DI ION VA</b>	Decentralized input module for PNOZmulti 2, PNOZmulti Mini and PNOZmulti	<ul style="list-style-type: none"> <li>▶ PL e of EN ISO 13849-1</li> <li>▶ SIL CL 3 of EN/IEC 62061</li> </ul>	<ul style="list-style-type: none"> <li>▶ PDP67 F 8DI ION _____ 773600</li> <li>▶ PDP67 F 8DI ION VA _____ 773614</li> </ul>
<b>PDP67 F 8DI ION HP, PDP67 F 8DI ION HP VA</b>	Decentralized input module for PNOZmulti 2, PNOZmulti Mini and PNOZmulti; high power; additional supply voltage for PSENslock and PSENopt		<ul style="list-style-type: none"> <li>▶ PDP67 F 8DI ION HP _____ 773601</li> <li>▶ PDP67 F 8DI ION HP VA _____ 773615</li> </ul>
<b>PDP67 F 4 code, PDP67 F 4 code VA</b>	Passive junction PSENcode		<ul style="list-style-type: none"> <li>▶ PDP67 F 4 code _____ 773603</li> <li>▶ PDP67 F 4 code VA _____ 773613</li> </ul>
<b>PDP67 Connector cs, PDP67 Connector cs VA</b>	Adapter for connection cable to the evaluation device	-	<ul style="list-style-type: none"> <li>▶ PDP67 Connector cs _____ 773610</li> <li>▶ PDP67 Connector cs VA _____ 773612</li> </ul>
<b>PDP20 F 4 mag</b>	Decentralized interface for series connection PSENmag	<ul style="list-style-type: none"> <li>▶ PL e of EN ISO 13849-1</li> <li>▶ SIL CL 3 of EN/IEC 62061</li> </ul>	773310

## ► Cable navigator

The cable navigator helps in the creation of your application. It provides a fast, simple overview of which cable and which adapter can be used to connect to the respective evaluation device and on various sensors.

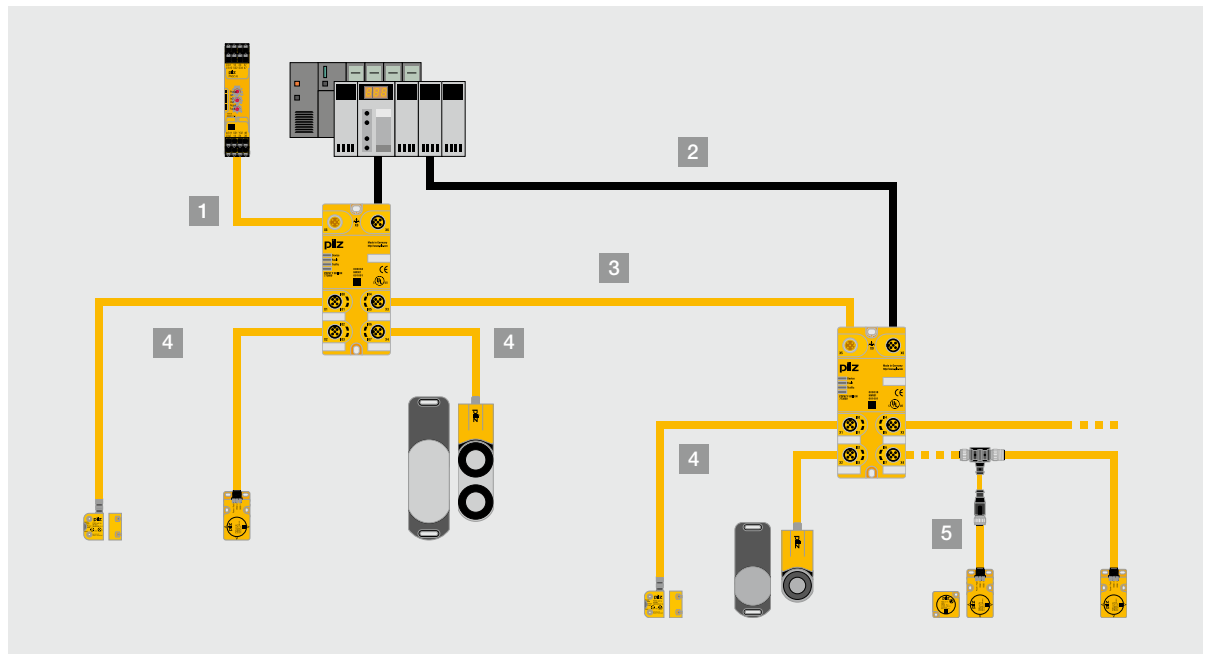

### Cable navigator

Type	Features	Order number					
		2 m	5 m	10 m	20 m	30 m	
<b>1</b> Connection cable evaluation device – PDP67 (X5)	PDP67 cable, straight, M12, 8-pin, open-ended connector	-	380 700	380 701	380 702	380 703	380 704
<b>2</b> Connection cable standard evaluation device – PDP67 (X6)	PDP67 cable, straight, M12, 8-pin, open-ended connector	-	380 700	380 701	380 702	380 703	380 704
<b>3</b> Connection cable PDP67 (X1-X4) – PDP67 (X5)	PSEN cable, straight, M12, 8-pin, plug/socket	-	540 340	540 341	540 342	540 343	540 344
<b>4</b> Connection cable PSENcode, PSENSlock, PSENini (X1-X4)	PSEN cable, straight, M12, 8-pin, plug/socket	-	540 340	540 341	540 342	540 343	540 344
<b>5</b> PSEN Y junction/ PSEN T junction	PSEN Y-junction M8-M12/M12 Series connection with M8, 8-pin	540 327	-	-	-	-	-
	PSEN Y-junction M12-M12/M12 Series connection with M12, 8-pin	540 328	-	-	-	-	-
	PSEN T-junction M12 diagnostic connector	540 331	-	-	-	-	-

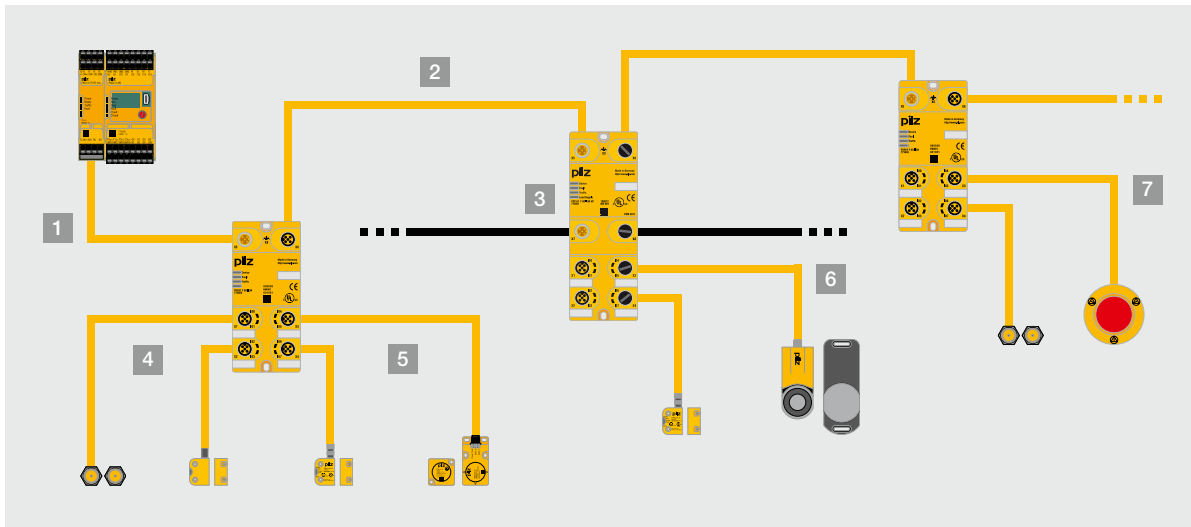

## Cable navigator

Type	Features	Order number					
		3 m	5 m	10 m	20 m	30 m	
<b>1</b> Connection cable PNOZ m EF PDP Link/ PNOZ ml2p/PNOZ mml2p – PDP67 (X5)	PSEN op cable, straight, M12, 5-pin, open-ended socket	-	630 310	630 311	630 312	630 298	630 297
<b>2</b> Connection cable PDP67 (X6) – PDP67 (X5)	PSS67 cable, straight, M12, 5-pin, plug/socket	-	380 208	380 209	380 210	380 220	380 211
<b>3</b> Supply cable PDP67 F 8DI ION HP (X7-X8)	X7: PSS67 supply cable, straight, M12, 5-pin, open-ended socket, B-coded	-	380 256	380 257	380 258	-	-
	X8 – X7: PSS67 supply cable, straight, M12, 5-pin, plug/socket, B-coded	-	380 250	380 251	380 252	-	-
<b>4</b> Connection cable PSENmag (X1-X4)	n-type: PSS67 cable, straight, M12, 5-pin, plug/socket	-	380 208	380 209	380 210	380 220	380 211
	p-type (M8-4pin): PSS67 cable, straight, M8, 5-pin, socket, M12, 5-pin, connector	-	380 200	380 201	380 202	380 203	-
	Adapter PSEN mag adapter	380 300	-	-	-	-	-
<b>5</b> Connection cable PSENcode (X1-X4)	n-type: PSS67 cable, straight, M12, 5-pin, plug/socket	-	380 208	380 209	380 210	380 220	380 211
	p-type: PSS67 cable, straight, M12, 5-pin, plug/socket	-	380 208	380 209	380 210	380 220	380 211
	Adapter PSEN cs adapter	380 301	-	-	-	-	-
<b>6</b> Connection cable PSENslock (X1-X4)	n-type: PSS67 cable, straight, M12, 5-pin, plug/socket	-	380 208	380 209	380 210	380 220	380 211
	p-type: PSS67 cable, straight, M12, 5-pin, plug/socket	-	380 208	380 209	380 210	380 220	380 211
	Adapter PSEN sl adapter	380 325	-	-	-	-	-
<b>7</b> Connection cable PIT, sensors without M12 connection (X1-X4)	PDP67 cable, straight, M12, 5-pin, open-ended connector	-	380 705	380 709	380 706	380 707	380 708

## ► Control systems and I/O systems PSSuniversal

The control systems and I/O systems PSSuniversal from Pilz can be used for the most diverse applications and offer maximum flexibility. Various hardware and software components for safety and automation enable different combinations for implementing your application. The systems are characterized by openness and simple operation.



PSSu H F PN

### **PSSuniversal – Decentralized I/O system**

The decentralized I/O systems PSSuniversal are used as remote I/O at field level and are the solution for tailor-made periphery expansion. Connection to a higher level control system is via common industrial communication protocols. A wide range of I/O modules enables the most diverse applications. The decentralized I/O systems can be configured using the PSSuniversal Assistant.



PSSu PLC1 FS SN SD

### **PSSuniversal – Control systems in the automation system PSS 4000**

Programmable control systems, configurable control systems and I/O systems are available in the automation system PSS 4000 – for safety and automation. Thanks to various device classes and software for configuration and programming, the system is scalable and can be used across industry.

Part of  
**PSS 4000**

Decentralized I/O systems

PLC control systems



### Modular system structure

The input and output modules on your control systems and I/O systems can be assembled to suit your particular requirements. So the system design can be tailored to your precise needs. If subsequent adaptations are required, modules can simply be expanded or exchanged.

#### 1 Head modules

Various head modules are available in a variety of performance classes.

#### 2 Input/output modules

For safety-related or non-safety-related, digital or analog signal processing. Up to 64 input/output modules can be installed in any order.

#### 3 Supply voltage modules

For the internal supply voltage and the formation of different supply groups for the decentralized I/O systems. This module can be used for the performance classes PSSuniversal PLC, multi and I/O as a "refresh module".

#### 4 Base modules

Carrier units for the input/output modules and for the supply voltage modules. These are simply inserted on to the base modules and are easy to change when adjustments are made to the system.

#### Your benefits at a glance

- ▶ Safety and automation functions can be processed
- ▶ Flexible application options due to modular system design
- ▶ Extensive selection of modules to meet your exact requirements
- ▶ Digital and analog processing
- ▶ Rapid installation, rapid module exchange even during operation
- ▶ High energy efficiency due to intelligent system design

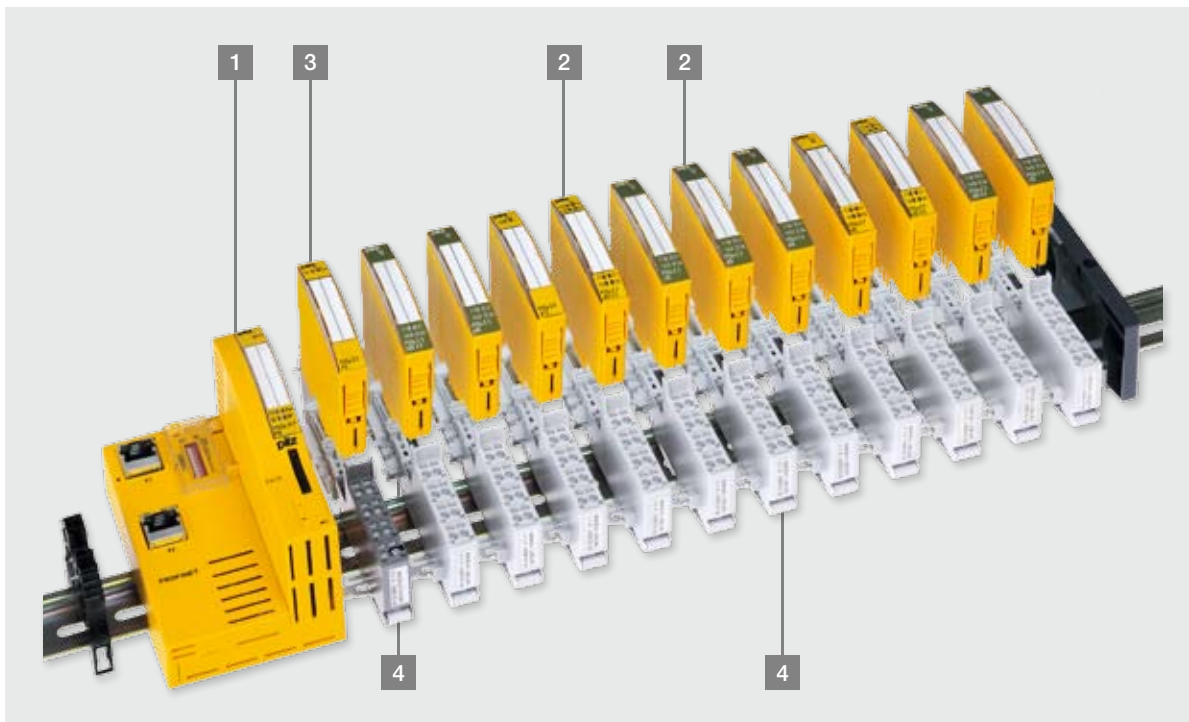

## ▶ Control systems and I/O systems PSSUniversal

With the programmable and configurable control systems and I/O systems PSSUniversal, applications for safety and automation can be implemented with ease and flexibility. The widest range of I/O modules enable these systems to be adapted specifically to your system environment.

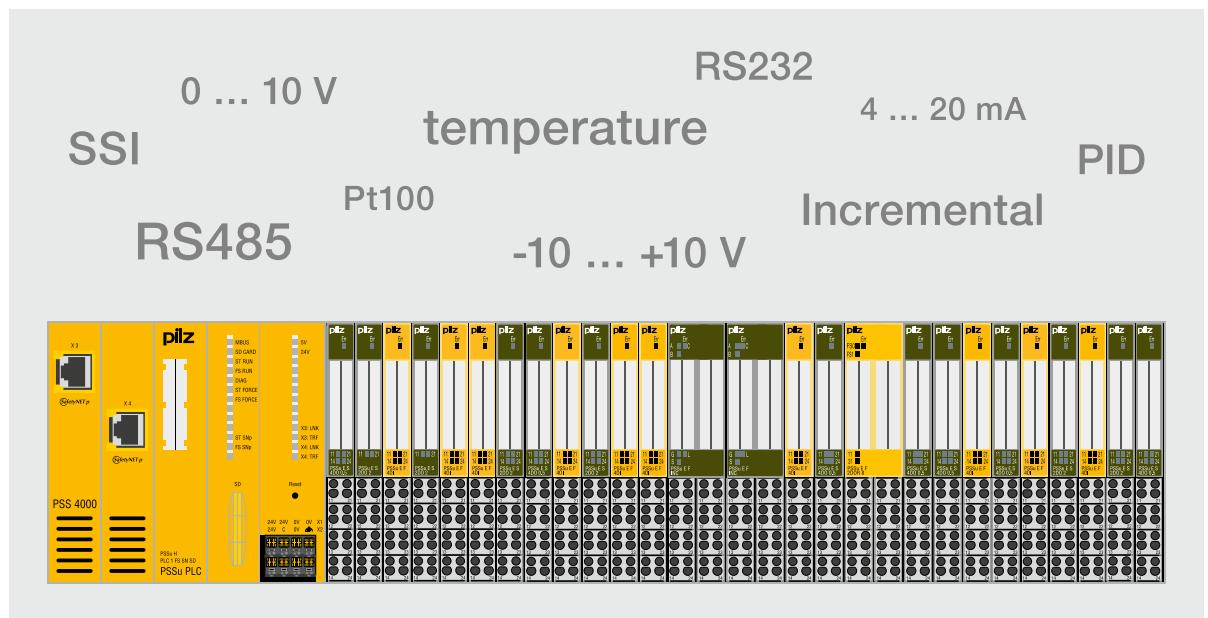

Decentralized I/O systems

PLC control systems



### An intelligent marriage of safety and automation

PSSUniversal supports a unique mix of safety and automation functions in one system. In doing so it meets safety-related requirements for absence of feedback and enables extremely short reaction times. As a result, PSSUniversal complies with EN/IEC 61508 up to SIL 3 and EN ISO 13849 up to PL e. When used in the control periphery, this feature enables physical integration of functions while maintaining logical separation. Planning and installation of the I/Os is simplified as a result and the space requirement is reduced.





Up to 50 % less energy consumption

**Energy efficiency – reduced energy consumption thanks to intelligent system design**

When processing safe signals the optimized system design enables a clear reduction in energy consumption. Depending on the number of safe modules required it is possible to save up to 50 % of power dissipation compared with other standard market systems. Because the entire safety logic is integrated in the PSSuniversal head module, less energy is consumed than with other systems. This reduces the power dissipation – the amount of power within a component that is converted into heat – which results in a significant energy saving. So you are actively protecting the environment.



**Push-in technology**

Devices with cage clamp terminals (push-in technology) offer huge gains in economy and safety. That’s because short commissioning and service times help to cut your costs. High contact reliability even under severe vibration and shaking enables device maintenance to be kept to a minimum.

**Temperature-resistant modules**

Rugged environments demand components that will operate reliably where there are high temperature fluctuations. Modules identified by a “-T” in the type description can be used in places where cabinet heating would be costly or uneconomical, or where heat is a key factor. The specified operating temperature range is from -40 °C to +70 °C. The modules are also protected against condensation in accordance with pollution degree 2. T-modules are suitable for applications such as wind turbines and cable cars, for example. In many cases, using these modules means there is no need for additional climate control measures, reducing costs considerably.

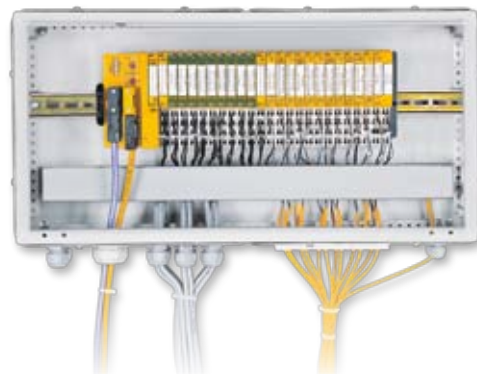

## ▶ Decentralized I/O system PSSUniversal

With the decentralized I/O system PSSUniversal, safety-related and/or automation functions are performed at field level. Communication at control level is via common fieldbus protocols. All sensor and actuator signals are connected to one module, so clear cabling is assured and errors during installation can be avoided.

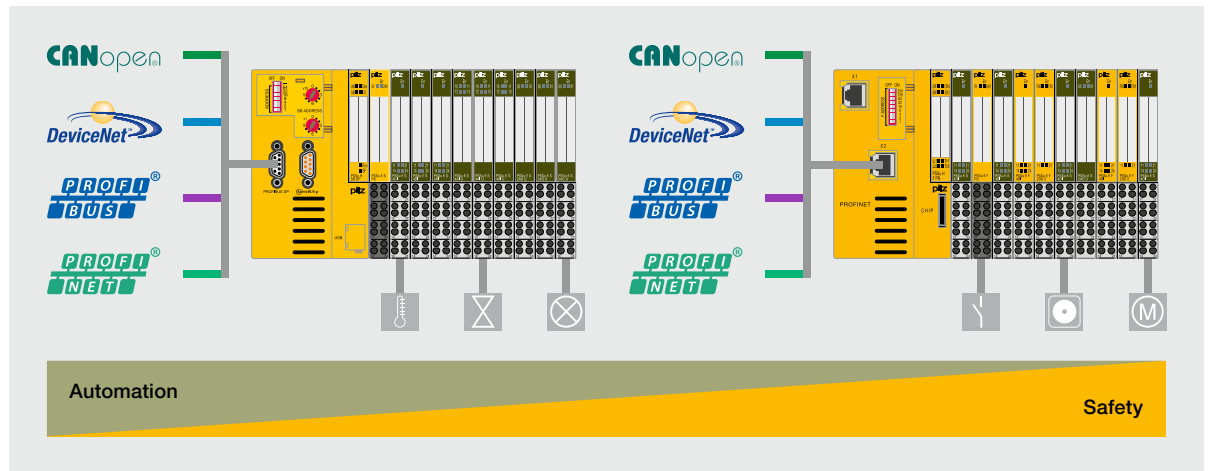

The decentralized I/O systems can be connected to various higher level control systems as an economical version of a remote system. As such the system represents a cost-effective solution for connecting periphery and safety-related functions to a central control system.

### Safe block switching of individual plant sections

Block switching is used to shut down the supply voltage to a group of standard outputs (e.g. several motors) when a hazardous event occurs. So, when a hazardous event does occur – e.g. an emergency stop pushbutton is operated – the safe shutdown of a complete plant section is guaranteed, while other sections can continue to operate.

### Your benefits at a glance

- ▶ Safety-related and/or automation functions are processed decentrally at field level
- ▶ Response times are reduced
- ▶ Optimum availability thanks to safe block switching
- ▶ Rapid commissioning and simple configuration due to independent periphery test





**Simple, configuration,  
fast commissioning**

The decentralized I/O systems are configured using the PSSUniversal Assistant. Thanks to the PSSUniversal Startup Tool the system can be commissioned quickly. You can already perform the first cable and function tests before the plant or machine is set up. That way all of the periphery is already tested and functional when you come to commission the plant. Commissioning work can be carried out independently and in parallel – reducing dependencies and saving time!

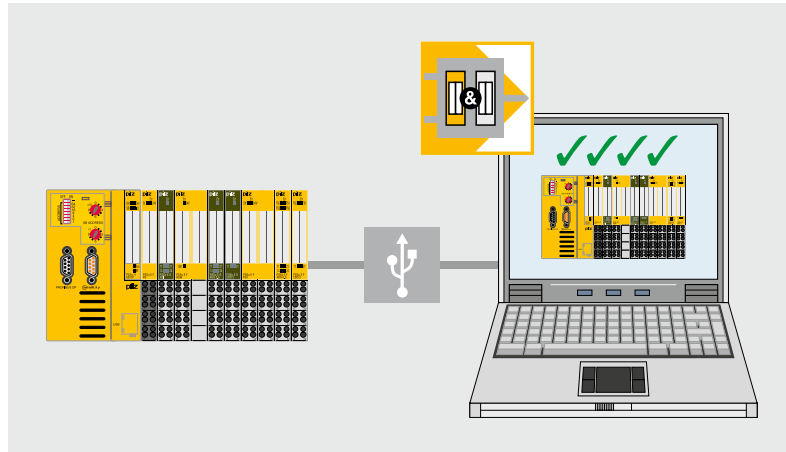

Cable and function tests are simply run through the USB port on the notebook.



**PSSUniversal –  
For PROFINET users too**

Optimized address management on the PROFINET versions of the decentralized I/O system are particularly convincing. The PROFINET – PROFIsafe address is only required once per decentralized station. This means, for example, that safety settings for each device only need to be made at a single point – in the head module. There is no need to set and manage the addresses for each individual I/O module. This provides optimum utilization of the failsafe addresses, saving you the work involved in planning and management.

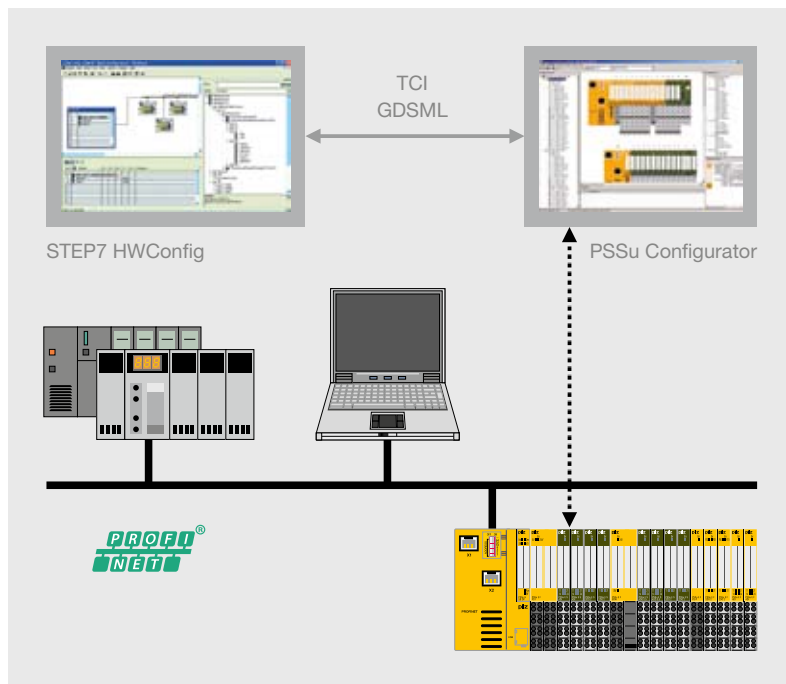

Comprehensive tool support for configuration, commissioning, diagnostics.

**PSSu Configurator**

- ▶ Called up via TCI
- ▶ Configures the system
- ▶ Generates station-specific GSDML files
- ▶ Manages all safety-related CRC sums

## ▶ PSSUniversal – Control systems in the automation



Various hardware device classes on the control systems PSSUniversal in the automation system PSS 4000 enable simple scalability. Thanks to the modular design they are versatile and expandable. In combination with network components you can implement various automation architectures, increasing the availability and extension of your network.

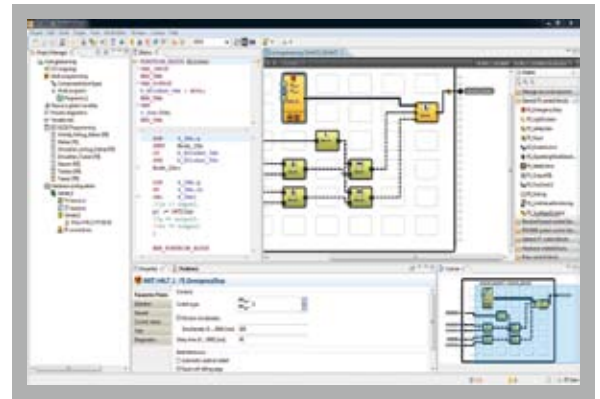
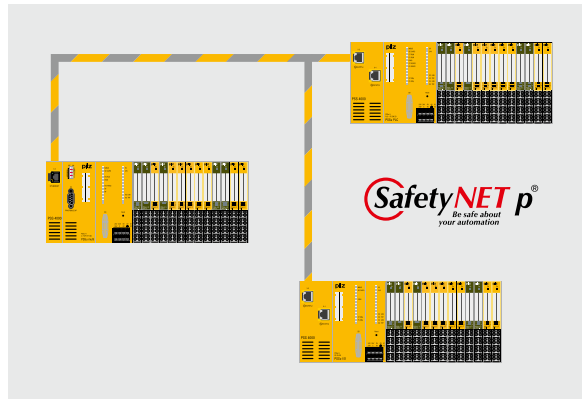

The control systems in **PSSUniversal PLC** are the “all-rounders” of the automation system PSS 4000. They can be used as “classic” centralized PLC control systems for safety and automation – or as a distributed system.

The control systems **PSSUniversal multi** can be used as mini controls in a system network – with PSSUniversal PLC or PSSUniversal I/O – or as stand-alone systems. As open control systems, they can be used in existing automation structures. Control systems PSSUniversal multi are suitable for individual machines or smaller networked plants.

The third device class **PSSUniversal I/O** is used for decentralized networking plus the transfer of safety-related and non-safety-related signals at field level. The most diverse range of applications can be implemented by connecting up to 64 I/O modules for safety and automation functions.

### Programming and configuration –

#### Simple handling for complex functions

A number of editors are available, enabling you to create programs for safety and automation functions quickly and intuitively. The graphics Program Editor PASmulti allows simple configuration/programming of the control systems PSSUniversal PLC and PSSUniversal multi. Inputs and outputs can be freely configured in the tool, while combination with the programming languages of the “IEC world” is also possible. The EN/IEC 61131-3-compliant Editors PAS STL (Structured Text), PAS LD (Ladder Diagram) and PAS IL (Instruction List) are used to program the control systems PSSUniversal PLC. A comprehensive library of safety-related and non-safety-related software blocks ensures a high level of standardization and reusability.

# system PSS 4000

**Shorter project run times –  
due to hardware-independent programming and the ability of subtasks to run in parallel.**

On many automation systems, hardware must be selected for the configuration/programming process. Subsequent modifications are very costly. With PSS 4000 it's different: in this case the hardware selection and distribution of the program to the hardware can take place very late in the process, as it is largely independent of the configuration stage.

Running subtasks in parallel: the hardware can be designed at the same time as the software is created for the control functions.

Flexible for subsequent changes: If you need to expand your application or machine, it is no problem to add another control system. Without a great deal of effort, the user program can then be divided over three control systems instead of two, for example.

By running subprocesses in parallel you can reduce the overall time for your engineering projects.

Reduce the overall time  
for your engineering projects!

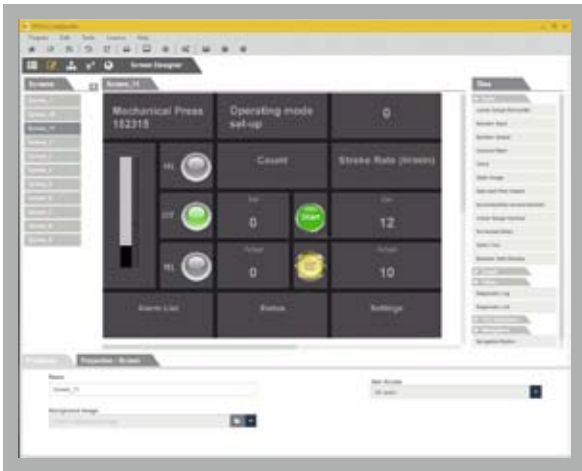

Professional diagnostics and visualization.



**Real-time-Ethernet SafetyNET p –  
Pure communication**

In addition to the connection to communication networks such as Ethernet/IP, EtherCAT, Modbus TCP Profinet and Profibus-DP, the control systems PSSuniversal PLC also have a SafetyNET p communication interface. SafetyNET p is the backbone of the whole system. Various infrastructure components such as switches enable the network to be adapted to the plant structure. Gateways are also available to connect to various third-party control systems.

Keep up-to-date  
on the automation  
system PSS 4000:



Webcode 5092

Online information  
at [www.pilz.com](http://www.pilz.com)

Decentralized I/O systems

PLC control systems

## ▶ Selection guide – Control systems and I/O systems

### Decentralized I/O system PSSuniversal – Head modules



PSSu H DP

Type	Application area	
	Failsafe functions	Automation functions
PSSu H CAN		◆
PSSu H DP		◆
PSSu H DN		◆
PSSu H F PN	◆	◆
PSSu H F PNo	◆	◆
PSSu H S PN		◆

### Automation system PSS 4000 – Head modules

Decentralized I/O systems



PSSuniversal PLC

Type	Application area	
	Failsafe functions	Automation functions
▶ PSSuniversal PLC		
PSSu H PLC1 FS SN SD	◆	◆
PSSu H PLC1 FS DP SN SD	◆	◆
▶ PSSuniversal multi		
PSSu H m F DP SN SD	◆	◆
PSSu H m F DP ETH SD	◆	◆
PSSu H m F DPsafe SN SD	◆	◆
▶ PSSuniversal I/O		
PSSu H FS SN SD	◆	◆



PSSuniversal multi

#### Common features

- ▶ PSSuniversal module bus for connecting up to 64 I/O modules for safety-related and non-safety-related functions
- ▶ Integral power supply
- ▶ Integrated switch function for SafetyNET p linear topology
- ▶ SD card to store the device project and configuration data
- ▶ International safety standards (EN/IEC 61508 up to SIL CL 3, EN ISO 13849 up to PL e), lift standard EN 81-1/2 and EN 50129
- ▶ Dimensions (H x W x D): 125.6 x 130 x 83.7 mm

PLC control systems

# PSSuniversal

Communication interfaces	Features	Order number	
		Regular version	T-Type <sup>1)</sup>
▶ CANopen (Slave, CANopen Standard 4.0)	▶ PSSuniversal module bus for connecting up to 64 I/O modules for safety-related and non-safety-related functions ▶ Dimensions (H x W x D): 128.4 x 75.2 x 79.4 mm	312 047	314 047
▶ PROFIBUS-DP (Slave)		312 045	314 045
▶ DeviceNet (Slave)		312 046	314 046
▶ 1 x PROFINET		312 040 (312 043) <sup>2)</sup>	-
▶ 1 x PROFIsafe		312 042	-
▶ 1 x PROFINET			
▶ 1 x PROFIsafe			
▶ Fiber-optic			
▶ 2 x PROFINET		312 041	-



Communication interfaces	Features	Order number	
		Regular version	T-Type <sup>1)</sup>
▶ 2 x SafetyNET p	▶ Can be configured with the graphics Program Editor PASmulti ▶ Programming in PAS IL (Instruction List), PAS LD (Ladder Diagram) and PAS STL (Structured Text) in accordance with EN/IEC 61131-3 ▶ Programming via Ethernet TCP/IP ▶ Max. number of failsafe tasks: 9 ▶ Max. number of standard tasks: 9	312 070	314 070
▶ SafetyNET p ▶ PROFIBUS-DP (Slave, DPV0)		312 071	-
▶ SafetyNET p ▶ PROFIBUS-DP (Slave, DPV0)	▶ Local safety functions ▶ Can be configured with the graphics Program Editor PASmulti ▶ Max. number of failsafe tasks: 1 ▶ Devices with SafetyNET p interface: Max. number of SafetyNET p connections: 5	312 065	-
▶ Ethernet ▶ PROFIBUS-DP (Slave, DPV0)		312 060	-
▶ SafetyNET p ▶ PROFIBUS/PROFIsafe (PROFIsafe V2.4)		312 066	-
▶ 2 x SafetyNET p	▶ Communication with other SafetyNET p devices (RTFN) ▶ Standard module bus for standard I/O modules	312 085	314 085

Keep up-to-date on:  
▶ PSSuniversal I/O systems

Webcode 5507

▶ PSSuniversal control systems

Webcode 6386

Online information at [www.pilz.com](http://www.pilz.com)

<sup>1)</sup> For increased environmental requirements

<sup>2)</sup> Half-byte version

Decentralized I/O systems

PLC control systems

## ► Selection guide – PSSuniversal

### Supply modules, junction modules and safe block switching module



PSSu E F PS



PSSu E PD

Type	Suitable for		Function	Application area		Electrical data	
	PSSuniversal – I/O system	PSSuniversal – Control systems PSS 4000		Failsafe functions	Automation functions	Supply voltage	Current load capacity Module supply
PSSu E F PS	◆	◆	Power supply	◆	◆	24 VDC	max. 1.5 A
PSSu E F PS1	◆	◆	Power supply, buffered	◆	◆	24 VDC	max. 2.0 A
PSSu E F PS2		◆	Power supply, buffered	◆	◆	24 VDC	max. 1.0 A
PSSu E F PS-P	◆	◆	Power supply, periphery	◆	◆	24 VDC	-
PSSu E PD	◆	◆	Voltage distribution		◆	-	-
PSSu E PD1	◆	◆	Voltage distribution		◆	-	-
PSSu S PD-D	◆	◆	Voltage distribution		◆	-	-
PSSu E F BSW	◆		Block switching function	◆	◆	24 VDC	-
PSSu E PS-P 5 V	◆	◆	Voltage distribution		◆	24 VDC	-
PSSu E PS-P +/- 10 V	◆	◆	Voltage distribution		◆	24 VDC	-
PSSu E PS-P +/- 15 V	◆	◆	Voltage distribution		◆	24 VDC	-

#### Type code for PSSuniversal electronic module/supply modules

PSSu E F 4DI

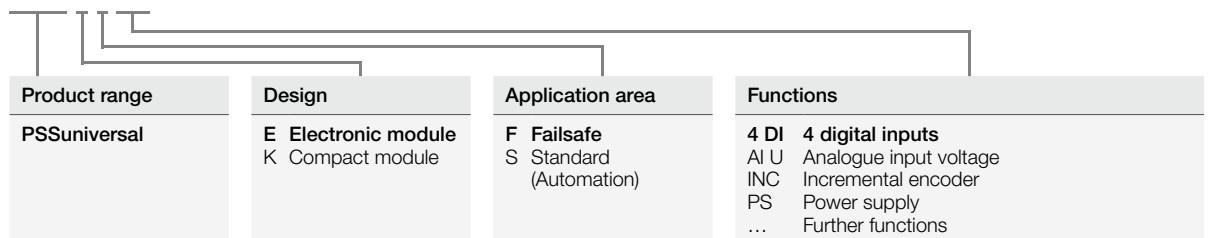

Current load capacity Periphery supply	Order number	Screw terminals <sup>1)</sup>										Cage clamp terminals <sup>1)</sup>													
		Suitable base module	Order number	312600	312610	312618	312618	312622	312628	312630	312650	312652	312654	312656	312601	312611	312619	312619	312623	312629	312631	312651	312653	312655	312657
max. 10 A	312 190 <sup>1)</sup>										♦	♦										♦	♦		
max. 10 A	312 191 <sup>1)</sup>											♦	♦											♦	♦
max. 10 A	312 192 <sup>1)</sup>												♦											♦	♦
max. 10 A	312 185 <sup>1)</sup>										♦												♦		
-	312 195 <sup>1)</sup>		♦	♦	♦	♦									♦	♦	♦	♦							
-	312 196 <sup>1)</sup>								♦	♦									♦	♦					
-	312 197		♦	♦	♦		♦								♦	♦	♦		♦						
max. 8 A	312 230 <sup>1)</sup>												♦												♦
-	312 590		♦		♦	♦									♦		♦	♦							
-	312 591		♦		♦	♦									♦		♦	♦							
-	312 592		♦		♦	♦									♦		♦	♦							

<sup>1)</sup>  The modules are also available as a T-type for enhanced environmental requirements. The order numbers for the T-type modules are 314... instead of 312...

<sup>2)</sup> Without C-rail  
<sup>3)</sup> With C-rail

Keep up-to-date on PSSuniversal I/O modules:

 Webcode 5502

Online information at [www.pilz.com](http://www.pilz.com)

## ▶ Selection guide – PSSuniversal

### Digital inputs and outputs



PSSu E F 4DI



PSSu E S 4DI

Type	Suitable for		Function	Application area	
	PSSuniversal – I/O system	PSSuniversal – Control systems PSS 4000		Failsafe functions	Automation functions
PSSu E F 4DI	◆	◆	4 digital inputs	◆	
PSSu E F 4DO 0,5	◆	◆	4 digital outputs	◆	
PSSu E F 2DO 2	◆	◆	2 digital outputs	◆	
PSSu E F DI OZ 2	◆	◆	1 digital input, 1 digital output	◆	
PSSu E F 2DOR 8	◆	◆	2 relay outputs	◆	
PSSu K F FCU		◆	12 digital inputs, 2 digital outputs (single-pole), 2 digital outputs (dual-pole), Fast Control Unit	◆	
PSSu E S 4DI	◆	◆	4 digital inputs		◆
PSSu E S 4DO 0.5	◆	◆	4 digital outputs		◆
PSSu E S 2DO 2	◆	◆	2 digital outputs		◆
PSSu E S 2DOR 10	◆	◆	2 relay outputs		◆
PSSu E S 2DOR 2	◆	◆	2 relay outputs		◆
PSSu K S 8DI 8DO 0.5	◆	◆	8 digital outputs, 8 digital inputs		◆
PSSu K S 16DI	◆	◆	16 digital inputs		◆
PSSu K S 16DO 0,5	◆	◆	16 digital outputs		◆

**Common features:**

- ▶ Voltage from module supply: 5 VDC
- ▶ Potential isolation



Electrical data	Order number		Screw terminals <sup>1)</sup>								Cage clamp terminals <sup>1)</sup>						
	Regular version	Diagnostic modules (-D)	Order number	312600	312610	312618	312620	312622	312628	312630	312601	312611	312619	312621	312623	312629	312631
Feature Inputs Outputs			Suitable base module	PSSu BP 1/8 S <sup>2)</sup>	PSSu BP-C 1/8 S <sup>3)</sup>	PSSu BP 1/12 S	PSSu BP-C 1/12 S	PSSu BP-C1 1/12 S	PSSu BP 2/16 S	PSSu BP-C 2/16 S	PSSu BP 1/8 C <sup>2)</sup>	PSSu BP-C 1/8 C <sup>3)</sup>	PSSu BP 1/12 C	PSSu BP-C 1/12 C	PSSu BP-C1 1/12 C	PSSu BP 2/16 C	PSSu BP-C 2/16 C
-	312200 <sup>1)</sup>	-		◆		◆		◆			◆		◆		◆		
0.5 A	312210 <sup>1)</sup>	-		◆	◆	◆		◆			◆	◆	◆		◆		
2 A	312215 <sup>1)</sup>	-		◆	◆	◆		◆			◆	◆	◆		◆		
1 (2 A), dual-pole 1 test pulse output	312220 <sup>1)</sup>	-		◆	◆	◆		◆			◆	◆	◆		◆		
2 N/O AC1: 250 V/8 A; 2000 V DC1: 24 V/8 A	312225 <sup>1)</sup>	-							◆	◆						◆	◆
- 2 (2 A), single-pole 2 (2 A), dual-pole	312437	-															
-	312400 <sup>1)</sup>	312401		◆	◆	◆		◆			◆	◆	◆		◆		
0.5 A	312405 <sup>1)</sup>	312406 <sup>1)</sup>		◆	◆	◆		◆			◆	◆	◆		◆		
2 A	312410 <sup>1)</sup>	312411 <sup>1)</sup>		◆	◆	◆		◆			◆	◆	◆		◆		
2 N/O	312510 <sup>1)</sup>	-							◆	◆						◆	◆
2 N/O	312511 <sup>1)</sup>	-		◆	◆	◆		◆			◆	◆	◆		◆		
0.5 A	312431 <sup>1)</sup>	-															
-	312430	-															
0.5 A	312432	-															

<sup>1)</sup>  The modules are also available as a T-type for enhanced environmental requirements. The order numbers for the T-type modules are 314... instead of 312...

<sup>2)</sup> Without C-rail

<sup>3)</sup> With C-rail

Keep up-to-date on PSSuniversal I/O modules:

 Webcode 5502

Online information at [www.pilz.com](http://www.pilz.com)

## ▶ Selection guide – PSSuniversal

### Analog inputs and outputs



PSSu E S 4AO U

Type	Suitable for		Function	Application area	
	PSSuniversal – I/O system	PSSuniversal – Control systems PSS 4000		Failsafe functions	Automation functions
PSSu E S 2AI U	◆	◆	2 analog inputs		◆
PSSu E S 4AI U	◆	◆	4 analog inputs		◆
PSSu E S 2AI I se	◆	◆	2 analog inputs		◆
PSSu E S 2AO U	◆	◆	2 analog outputs		◆
PSSu E S 4AO U	◆	◆	4 analog outputs		◆
PSSu E S 2AO I	◆	◆	2 analog outputs		◆
PSSu E S 2AI RTD	◆	◆	2 analog inputs		◆
PSSu E S 2AI TC	◆	◆	2 analog inputs		◆
PSSu E F AI I		◆	1 analog input	◆	
PSSu E F AI U		◆	1 analog input	◆	

### Counter modules



PSSu E S INC

PSSu E S ABS SSI	◆	◆	Absolute encoder SSI		◆
PSSu E S INC	◆	◆	Incremental encoder		◆
PSSu E S INC 24 se	◆	◆	Incremental encoder		◆
PSSu E F ABS SSI		◆	Absolute encoder SSI	◆	
PSSu E F INC		◆	Incremental encoder	◆	
PSSu K F INC		◆	Incremental encoder	◆	

### Electronic modules with serial interface



PSSu E S RS232

PSSu E S RS232	◆	◆	RS232 interface		◆
PSSu K S RS232		◆	RS232 interface		◆
PSSu E S RS485	◆	◆	RS485 interface		◆

Electrical data	Order number	Screw terminals <sup>1)</sup>										Cage clamp terminals <sup>1)</sup>									
		Suitable base module	Order number	Order number	Order number	Order number	Order number	Order number	Order number	Order number	Order number	Order number	Order number	Order number	Order number	Order number	Order number	Order number	Order number	Order number	Order number
0 ... 10 V s.e.; diff; -10 ... +10 V	312 440 <sup>1)</sup>	PSSu BP 1/8 S <sup>2)</sup>	312 600	312 610	312 602	312 612	312 618	312 620	312 622	312 628	312 630	PSSu BP 1/8 C <sup>2)</sup>	312 611	312 612	312 603	312 613	312 619	312 621	312 623	312 629	312 631
0 ... 10 V s.e.	312 445 <sup>1)</sup>		◆	◆			◆	◆				◆	◆			◆	◆				
0 ... 20 mA; 4 ... 20 mA	312 450 <sup>1)</sup>		◆	◆								◆	◆								
0 ... 10 V; -10 ... +10 V	312 460 <sup>1)</sup>		◆	◆								◆	◆								
0 ... 10 V	312 465 <sup>1)</sup>		◆	◆			◆	◆				◆	◆			◆	◆				
0 ... 20 mA; 4 ... 20 mA	312 470 <sup>1)</sup>		◆	◆								◆	◆								
-	312 490 <sup>1)</sup>						◆	◆								◆	◆				
Thermocouples	312 500 <sup>1)</sup>				◆	◆								◆	◆						
0 ... 25 mA	312 260 <sup>1)</sup>		◆	◆			◆	◆				◆	◆			◆	◆				
-10 ... +10 V	312 265 <sup>1)</sup>		◆	◆			◆	◆				◆	◆			◆	◆				
SSI	312 480 <sup>1)</sup>		◆	◆								◆									
INC	312 485 <sup>1)</sup>											◆	◆						◆	◆	
INC	312 486 <sup>1)</sup>											◆	◆						◆	◆	
SSI	312 275 <sup>1)</sup>		◆	◆								◆	◆								
INC	312 280 <sup>1)</sup>											◆	◆						◆	◆	
INC	312 437 <sup>1)</sup>																				
-	312 515 <sup>1)</sup>		◆	◆			◆	◆				◆	◆			◆	◆				
-	312 438 <sup>1)</sup>																				
-	312 516 <sup>1)</sup>		◆	◆			◆	◆				◆	◆			◆	◆				

<sup>1)</sup>  The modules are also available as a T-type for enhanced environmental requirements. The order numbers for the T-type modules are 314... instead of 312...

<sup>2)</sup> Without C-rail  
<sup>3)</sup> With C-rail

Keep up-to-date on PSSuniversal I/O modules:

 Webcode 5502

Online information at [www.pilz.com](http://www.pilz.com)

## ▶ Selection guide – PSSuniversal accessories

### PSSuniversal accessories



PSSu XB F-T



PSSu XR F-T



SD Memory Card  
512MB

Type	Function	Order number	Suitable for
PSSu XB F-T	Base station used to extend the PSSu module bus by 0.5 m or 1 m, inside the control cabinet	314 092 <sup>1)</sup>	<ul style="list-style-type: none"> <li>▶ PSSu BP 2/16 S 312 628</li> <li>▶ PSSu BP 2/16 C 312 629</li> <li>▶ PSSu BP-C 2/16 S 312 630</li> <li>▶ PSSu BP-C 2/16 C 312 631</li> </ul>
PSSu XR F-T	Remote station used to extend the PSSu module bus by 0.5 m or 1 m, inside the control cabinet	314 093 <sup>1)</sup>	Connection cable PSSu A RJ45-CAB 1.5M 314 094
PSSu A ET	End bracket for top-hat rail	312 900	-
PSSu A ETM	End bracket for top-hat rail, metal version, for high mechanical stresses	312 901	-
PSSu A EC	Terminating plate with integral terminating resistor	312 902 314 902 <sup>1)</sup>	-
PSSu A ET PE	Earthing terminal for top-hat rail, PE connection, Gr/Y	312 949	-
PSSu A USB-CAB03	PSSu USB cable, length 3 m	312 992	-
PSSu A USB-CAB05	PSSu USB cable, length 5 m	312 993	-
SD Memory Card 512MB	512 MB SD memory card for PSSu head modules	313 100	-
PSSu A Con 1/4 S	Connector set for power supply, 1-row, 4-pin, screw connection	313 110	Head modules in the automation system PSS 4000 (page 100)
PSSu A Con 2/8 C	Connector set for power supply, 2-row, 8-pin, spring loaded connection	313 111	Head modules in the automation system PSS 4000 (page 100)
PSSu A Con 1/10 C	Connector set for compact modules, 1-row, 10-pin, spring loaded connection	313 115	-
PSSu A Con 3/30 C	Connector set for compact modules, 3-row, 30-pin, spring loaded connection	313 116	-
PSSu A Con 4 S	Connector for compact modules, 4-pin, screw connection, crosslinked polyethylene 1 connector	313 117	-

<sup>1)</sup>  The modules are also available as a T-type for enhanced environmental requirements.

Keep up-to-date on PSSuniversal accessories:

 Webcode 5502

Online information at [www.pilz.com](http://www.pilz.com)

# ► Selection guide – Infrastructure components

## Unmanaged switches PSSnet SLL



PSSnet SLL 5T

Type	Technical features	Order number
PSSnet SLL 5T	5 electrical ports	380600
PSSnet SLL 4T 1FMMSC	4 electric ports, 1 fiber-optic port, multimode port	380604

### Common features

- Plug-and-play (no configuration necessary)
- Diagnostic LEDs

## Managed switches PSSnet SHL



PSSnet SHL 6T  
2FSMSC MRP

PSSnet SHL 8T MRP	8 electrical ports	380601
PSSnet SHL 6T 2FMMSC MRP	6 electric ports, 2 fiber-optic ports, multimode port	380602
PSSnet SHL 6T 2FSMSC MRP	6 electric ports, 2 fiber-optic ports, single-mode port	380650

### Common features

- Extensive management functions for configuration and diagnostics
- Web-based management for access via web browser
- Ring redundancy MRP
- Redundant voltage supply

## SafetyNET p connector, cable, stripping tool



SafetyNET p  
Connector RJ45s



SafetyNET p  
Cable

SafetyNET p Connector RJ45s	Standard connector for IP20 installation, quick connection, RJ45 mating face, housing form compatible with PSSuniversal stabilizing collar, ambient temperature: -40 °C ... +70 °C	380400
SafetyNET p Cable	Cable (by the meter), conductor cross-section AWG 22, CAT 5e, 4-core	380000
SN CAB RJ45s RJ45s, 0.5m	0.5 m cable with 2 x RJ45 connector	380001
SN CAB RJ45s RJ45s, 1m	1 m cable with 2 x RJ45 connector	380003
SN CAB RJ45s RJ45s, 2m	2 m cable with 2 x RJ45 connector	380005
SN CAB RJ45s RJ45s, 5m	5 m cable with 2 x RJ45 connector	380007
SN CAB RJ45s RJ45s, 10m	10 m cable with 2 x RJ45 connector	380009
Stripping Tool	Installation tool for SafetyNET p cable and connector	380070

Keep up-to-date on:  
► Infrastructure components  
SafetyNET p

Webcode 6548

## Gateways



PSSnet GW1  
MOD-EtherCAT

PSSnet GW1 MOD-CAN	Protocol converter from Modbus/TCP Slave to CANopen Slave	311602
PSSnet GW1 MOD-EtherCAT	Protocol converter from Modbus/TCP Slave to EtherCat Slave	311601

► Gateways

Webcode 5542

Online information at [www.pilz.com](http://www.pilz.com)

## ▶ Selection guide – System and tool software

### Configuration tools for decentralized I/O system PSSUniversal



Type	Features	Order number
<b>PSSUniversal Startup Software incl. PSSUniversal Assistant</b> Configuration and independent periphery test of the decentralized I/O system PSSUniversal	<ul style="list-style-type: none"> <li>▶ Function test performed on a PSSUniversal system via the USB port, without the controller connected</li> <li>▶ FS and ST outputs are switched on/off</li> <li>▶ Input status display (supports the panel builder, for example, during the wiring test)</li> <li>▶ Online help</li> </ul>	<ul style="list-style-type: none"> <li>▶ Software CD-ROM _____ 312 890</li> <li>▶ Single-user licence (Basic)<sup>1)</sup> _____ 312 890B</li> <li>▶ Additional licence (User)<sup>1)</sup> for one additional workstation ____ 312 890K</li> </ul>

<sup>1)</sup> Free licence for Startup Software PSSUniversal Assistant



### Software in the automation system PSS 4000



Type	Features	Order number
<b>PAS4000</b> Software platform in the automation system PSS 4000	<ul style="list-style-type: none"> <li>▶ Editors PAS STL, PAS IL, PAS LD in accordance with EN/IEC 61131-3</li> <li>▶ Graphics Program Editor PASmulti</li> <li>▶ Online help</li> <li>▶ Special licence model</li> </ul>	Software available to download, <a href="http://www.pilz.com/pss4000">www.pilz.com/pss4000</a>  PASunits: Once production operation is enabled, the project is licensed in PAS4000, PASunits are calculated for the functions used and credited to the project from the software's points account  <ul style="list-style-type: none"> <li>▶ PASunits 500 _____ 317 910</li> <li>▶ PASunits 1000 _____ 317 920</li> <li>▶ PASunits 5000 _____ 317 930</li> <li>▶ PASunits 10000 _____ 317 940</li> <li>▶ PASkey: USB crypto memory for secure storage and transfer of PASunits _____ 317 999</li> </ul>

Decentralized I/O systems

PLC control systems

Keep up-to-date on:  
 ▶ PSSUniversal Tools

Webcode 8643

▶ PSS 4000 Tools

Webcode 6493

Online information at [www.pilz.com](http://www.pilz.com)

# ► Selection guide – Software blocks PAS4000



## General failsafe control blocks



FS\_EmergencyStop



FS\_TwoHandControl

Type	Function
<b>FS_EmergencyStop</b>	Configures and monitors the function of E-STOP pushbuttons with one or two N/C contacts.
<b>FS_LightCurtain</b>	Monitors the function of light grids with 2 N/C contacts.
<b>FS_SafetyGate</b>	Monitors the function of safety gate switches with up to 3 contacts.
<b>FS_Operating ModeSelectorSwitch</b>	Monitors up to 8 positions on an operating mode selector switch. Unneeded inputs may remain unassigned. Once the switchover time has elapsed, only one contact at a time may be closed.
<b>FS_SafetyValve</b>	Monitors the operation of safety valves of the single, double or directional type.
<b>FS_TwoHandControl</b>	Monitors whether the two pushbuttons of the two-hand control are operated simultaneously (within 0.5 s). In accordance with EN 574, two-hand pushbuttons of type IIIA (2 N/O contacts) or type IIIC (combination of 2 N/O and 2 N/C contacts) can be used.
<b>FS_Muting</b>	Used to temporarily suspend safety functions (ESPE/AOPD) without interrupting the process (muting), in accordance with EN 61496-1.

## Hardware-related blocks



FS\_Incremental Encoder

<b>FS_CounterDual</b>	In conjunction with the blocks FS_AbsoluteEncoder and/or FS_IncrementalEncoder, calculates the following safe values: Position, speed, standstill.
<b>FS_Absolute Encoder</b>	Calculates a counter status (in increments) from the measured value from the absolute encoder and monitors the module status.
<b>FS_Incremental Encoder</b>	Initializes the counter, calculates the current counter status (in increments) and transmits status information.
<b>FS_AnalogueInput Dual</b>	Monitors redundant, analog input values for upward violation of a value range, downward violation of a value range and upward violation of a difference between the analog input value 0 and analog input value 1 over a defined period of time (feasibility check).
<b>FS_Scaling</b>	Scales an analog input value and sends it to an O-variable.

## Press control blocks



FS\_CamController

<b>FS_PressOperating Modes</b>	Controls and monitors the setup, single stroke and automatic operating modes of a mechanical press.
<b>FS_CamEvaluation</b>	Monitors the mechanical rotary cam arrangement of a press for: Feasibility of the signals from the overrun cam and run-up cam, failure of the dynamic cam and overrun cam, upward violation of the overrun at top dead center.
<b>FS_CycleMode LightCurtain</b>	Enables cycle mode (control) for triggering the press stroke when using a light curtain in the standard and Sweden operating modes.
<b>FS_CamController</b>	Provides the position signals for a press control. It uses the angle values, e.g. from the block S_PositionToAngle, to determine the signal for achieving top dead center, enabling the press to be shut down. It is used in a safe, electronic rotary cam arrangement.

Keep up-to-date on PAS4000

Webcode 6493

Online information at [www.pilz.com](http://www.pilz.com)

The software modules of the PAS4000 can be found directly using the tool in the software library.  
Tool download: [www.pilz.com/PSS4000](http://www.pilz.com/PSS4000)

## ▶ Did you know?

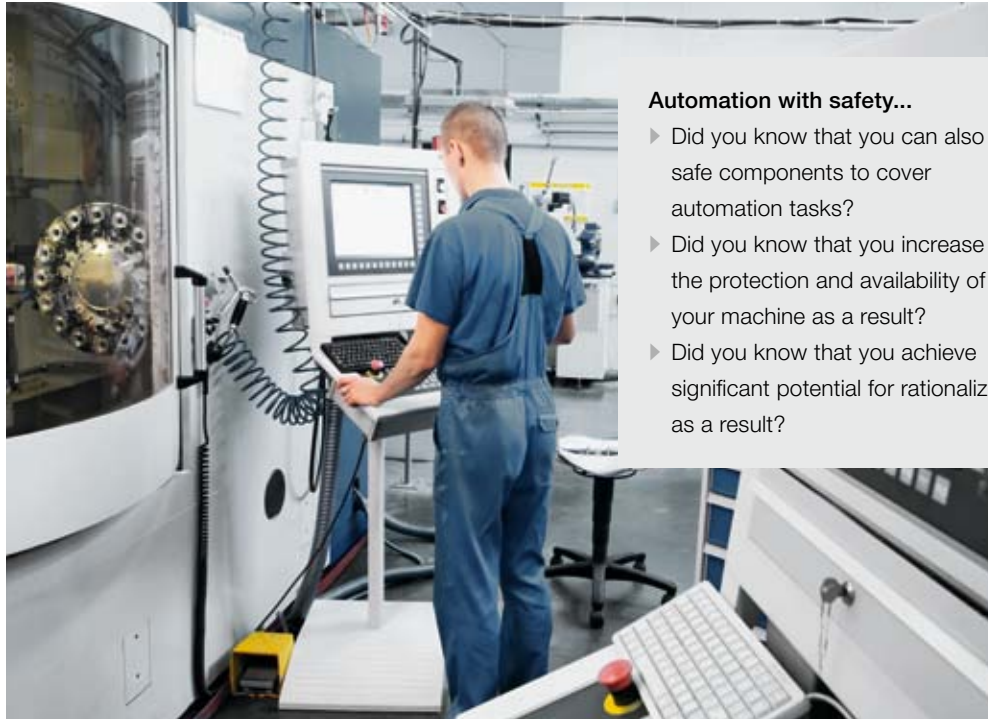

### Automation with safety...

- ▶ Did you know that you can also use safe components to cover automation tasks?
- ▶ Did you know that you increase the protection and availability of your machine as a result?
- ▶ Did you know that you achieve significant potential for rationalization as a result?

### Using safe components to cover automation tasks

Our development work is carried out to the most stringent standards. For example, our quality management is based on certification in accordance with DIN EN ISO 9001: 2008! We have specific demands on processes, quality and stability during development and production. Our safety products and the corresponding processes are also subjected to a formal test process and have been approved by external authorities such as TÜV and BG.

Result: they are of the highest quality.

**So it's no surprise that our products – which were originally designed for safety – are increasingly being used for non-safety-related applications.**

### High availability for your machines – thanks to early fault detection

Continuous tests within the safety product and connected periphery are a basic principle of safety technology. Valuable diagnostic information is produced as a result. Safety is used as a diagnostic instrument in this case, increasing the availability of your plant and machinery!

- ▶ Reduced recommissioning times thanks to fast, precise fault localization
- ▶ Faults are detected early thanks to clear identification and assignment
- ▶ Analysis is simple thanks to built-in / automatic storage of fault states – even retrospectively
- ▶ Continuous performance test provides constant quality information

Safety technology provides a greater “breadth and depth of diagnostics” than conventional automation technology and saves operating costs.





**Products that won't be thrown off course**

The level and requirements of the safety technology are very high – so our safety components have a dual-channel structure, for example. Extensive module tests (in accordance with IEC 61508) are a matter of course.

Also, all our components comply with the EMC Directive and can be used in an extended temperature range, so they are particularly robust. They withstand environmental influences, are less susceptible to faults and highly available within the application.

- ▶ High safety requirements – can be transferred to the automation technology
- ▶ High-quality products for lasting availability
- ▶ Good diagnostic options due to safety components in general automation functions
- ▶ Robust, hard-wearing products – comply with the EMC Directive



EMV



PNOZ m B0

**Potential for rationalization:  
safety components cover automation tasks**

Take control technology as an example: the configurable control systems PNOZmulti are mainly used to implement multiple safety functions. They are also powerful enough to assume complete machine control on smaller machines. Machine builders and operators can rely on high-quality, available products. What's special here is that they do not need an additional control system and so can make savings in many different areas. Reduce your hardware costs and enjoy having space in the control cabinet (the PNOZmulti 2 base unit is only 45 mm wide!). So you can keep your purchasing and stockholding costs low.

You have just one contact for safety and automation!

## ► Consulting, engineering and training

As a solution supplier, Pilz can help you to apply optimum safety strategies worldwide. Services encompass the whole machine lifecycle. Our training package with practical, up-to-date course content completes the offering.



### We are your reliable service provider for plant and machinery safety

Your projects belong in our safe hands!



#### Risk assessment

We inspect your machinery in accordance with the applicable national and/or international standards and directives and assess the existing hazards.



#### Safety concept

We develop detailed technical solutions for the safety of your plant and machinery through mechanical, electronic and organizational measures.



#### Safety design

The aim of the safety design is to reduce or eliminate danger points through detailed planning of the necessary safeguards.



#### System implementation

The results of the risk analysis and safety design are implemented to suit the particular requirements through selected safety measures.



Our management system was certified in the field of system integration to EN/IEC 61508.

Services related to machinery safety:

Webcode:  
web7792

Online information at [www.pilz.com](http://www.pilz.com)



#### Safety validation

In the safety validation, the risk assessment and safety concept are mirrored and inspected by competent, specialist staff.



#### CE marking

We control all activities and processes for the necessary conformity assessment procedure, including the technical documentation that is required.



### International compliance services

We conduct the evaluation process and develop the necessary strategies in order to enable compliance with the relevant ISO, IEC, ANSI, EN or other national or international standards.



### Plant assessment

We will prepare an overview of your entire plant in the shortest possible time. With an on-site inspection we will expose risks and calculate the cost of optimizing your safeguards.



### Inspection of safeguards

With our independent, ISO 17020-compliant inspection body, which is accredited by the German Accreditation Body (DAkkS), we can guarantee objectivity and high availability of your machines.



Pilz GmbH & Co. KG, Ostfildern operates an inspection body for plant and machinery, accredited by DAkkS.



### LOTO System

Our customized Lock Out Tag Out (LOTO) measures guarantee that staff can safely control potentially hazardous energies during maintenance and repair.



### Training

Pilz offers two types of courses: Product-neutral seminars on machinery safety and product-specific courses



And to progress to the expert level in machinery safety we offer the qualification of CMSE® – Certified Machinery Safety Expert.

Knowledge is a competitive edge – Pilz training courses:

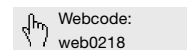

Online information at [www.pilz.com](http://www.pilz.com)

## ▶ Index for control technology

- ▶ **A**
  - Absolute encoder \_\_\_\_\_ 106
  - AC/DC supplies \_\_\_\_\_ 11, 12
  - Address management \_\_\_\_\_ 97
  - Analog input signals \_\_\_\_\_ 74
  - Analog outputs \_\_\_\_\_ 11, 12
- ▶ **B**
  - Base modules \_\_\_\_\_ 93, 103ff
  - Base units \_\_\_\_\_ 50, 56ff, 68ff, 74ff
  - Block switching \_\_\_\_\_ 96
  - Brake control \_\_\_\_\_ 23
  - Burner controls \_\_\_\_\_ 21, 74
  - Burner management \_\_\_\_\_ 21, 75
- ▶ **C**
  - Communication networks \_\_\_\_\_ 57, 60, 96, 99
  - Configurable control systems \_\_\_\_\_ 56ff, 88, 113
  - Configurable safety systems \_\_\_\_\_ 56, 74
  - Configurable small control systems \_\_\_\_\_ 56, 68
  - Configuration \_\_\_\_\_ 11, 58, 84, 92, 96, 98
  - Contact expansion \_\_\_\_\_ 19, 20, 69
  - Control systems \_\_\_\_\_ 9, 92, 95, 99
- ▶ **D**
  - Decentralization \_\_\_\_\_ 8, 63, 88, 98
  - Decentralized modules \_\_\_\_\_ 63, 89
  - Diagnostic concept PVIS \_\_\_\_\_ 59
  - Diagnostics \_\_\_\_\_ 11, 14, 40, 51, 59
  - Direction of rotation \_\_\_\_\_ 20, 80
  - Diverse safety contacts \_\_\_\_\_ 21
  - Drive monitoring \_\_\_\_\_ 20, 62, 74, 80
- ▶ **E**
  - E-STOP \_\_\_\_\_ 8, 14, 19, 30, 41, 50, 74, 96
  - Earth fault monitoring \_\_\_\_\_ 12
  - Electrical safety \_\_\_\_\_ 10, 11
  - Electronic monitoring relays \_\_\_\_\_ 10, 13
  - EN/IEC 61131-3 \_\_\_\_\_ 98
  - Energy efficiency \_\_\_\_\_ 61, 93, 95
  - Extended temperature range (coated version) \_\_\_\_\_ 27, 29, 71, 77ff, 95, 101ff
- ▶ **F**
  - Fieldbus modules \_\_\_\_\_ 57, 59
  - Fill level \_\_\_\_\_ 10
- ▶ **H**
  - Head modules \_\_\_\_\_ 93, 100
- ▶ **I**
  - I/O systems \_\_\_\_\_ 92ff
  - Incremental encoder \_\_\_\_\_ 62, 106
  - Independent periphery test \_\_\_\_\_ 96
  - Infrastructure components \_\_\_\_\_ 99, 109
  - Input/output modules \_\_\_\_\_ 93, 102ff
  - Instruction List \_\_\_\_\_ 98, 101, 110
  - Insulation monitoring \_\_\_\_\_ 12
  - Insulation resistance \_\_\_\_\_ 11
  - IP67 \_\_\_\_\_ 88
- ▶ **L**
  - Ladder Diagram \_\_\_\_\_ 98, 101, 110
  - Lift standard \_\_\_\_\_ 21, 100
  - Light beam devices \_\_\_\_\_ 8, 14, 30, 38, 74
  - Line inspection \_\_\_\_\_ 49
  - Link modules \_\_\_\_\_ 63, 70, 80
- ▶ **M**
  - Machine control system \_\_\_\_\_ 57, 113
  - Macro elements \_\_\_\_\_ 58
  - Modular structure \_\_\_\_\_ 93, 98
  - Motion monitoring \_\_\_\_\_ 57, 62
  - Muting \_\_\_\_\_ 30, 37
- ▶ **N**
  - Networks \_\_\_\_\_ 9, 57, 99
- ▶ **O**
  - Operating modes \_\_\_\_\_ 14, 18, 75
  - Overload and underload monitoring \_\_\_\_\_ 11, 12
- ▶ **P**
  - PDP20 \_\_\_\_\_ 88
  - PDP67 \_\_\_\_\_ 88, 90
  - Phase sequence monitoring \_\_\_\_\_ 12, 13
  - PLIDdys \_\_\_\_\_ 48
  - PMDsigma \_\_\_\_\_ 10
  - PMDsrange \_\_\_\_\_ 12
  - PNOZ \_\_\_\_\_ 14, 16
  - PNOZcompact \_\_\_\_\_ 38
  - PNOZelog \_\_\_\_\_ 40
  - PNOZmulti 2 \_\_\_\_\_ 56, 60, 62
  - PNOZmulti \_\_\_\_\_ 56, 74
  - PNOZmulti Configurator \_\_\_\_\_ 58
  - PNOZmulti Mini \_\_\_\_\_ 56, 68
  - PNOZpower \_\_\_\_\_ 50
  - PNOZsigma \_\_\_\_\_ 18, 20, 22
  - PNOZ X \_\_\_\_\_ 30
  - Position monitoring \_\_\_\_\_ 20, 57, 62
  - Presses \_\_\_\_\_ 8, 75
  - Programming \_\_\_\_\_ 92, 98
  - PSS 4000 \_\_\_\_\_ 92, 98ff
  - PSSuniversal \_\_\_\_\_ 92, 94, 96, 98
  - PSSuniversal Assistant \_\_\_\_\_ 92, 97
  - PSSuniversal I/O \_\_\_\_\_ 98
  - PSSuniversal multi \_\_\_\_\_ 98
  - PSSuniversal PLC \_\_\_\_\_ 98
  - Push-in technology \_\_\_\_\_ 14, 19, 39, 95
  - PVIS \_\_\_\_\_ 59, 69
- ▶ **R**
  - Real-time Ethernet \_\_\_\_\_ 8, 99
  - Remote system \_\_\_\_\_ 96
  - Reusability \_\_\_\_\_ 98
- ▶ **S**
  - Safe block switching \_\_\_\_\_ 96
  - Safe direction \_\_\_\_\_ 20, 62
  - Safe operating stop \_\_\_\_\_ 20, 62
  - Safe speed monitoring \_\_\_\_\_ 20, 62
  - Safe speed range \_\_\_\_\_ 20, 62
  - Safety circuit \_\_\_\_\_ 58
  - Safety contacts \_\_\_\_\_ 14, 21, 50
  - Safety gates \_\_\_\_\_ 8, 14, 30, 38, 74
  - SafetyNET p \_\_\_\_\_ 8, 99
  - Safety relays \_\_\_\_\_ 15ff, 88
  - Safety standard \_\_\_\_\_ 57, 59, 60, 68
  - Scalability \_\_\_\_\_ 98
  - Semiconductor output module \_\_\_\_\_ 75
  - Set-up mode \_\_\_\_\_ 20, 75
  - Shear pin breakage \_\_\_\_\_ 20
  - Short commissioning time \_\_\_\_\_ 13, 59
  - Software \_\_\_\_\_ 8, 58, 84, 92, 98, 110
  - Speed monitoring \_\_\_\_\_ 20, 30, 62, 74, 80
  - Standardization \_\_\_\_\_ 98
  - Standards \_\_\_\_\_ 8
  - Standstill monitoring \_\_\_\_\_ 20, 30, 57, 74, 80
  - Startup tool \_\_\_\_\_ 97, 110
  - Structured Text \_\_\_\_\_ 98, 101, 110
  - Supply voltage modules \_\_\_\_\_ 93
- ▶ **T**
  - TCI \_\_\_\_\_ 97
  - Temperature-resistant modules \_\_\_\_\_ 95
  - Temperature monitoring \_\_\_\_\_ 12, 13
  - Timer functions \_\_\_\_\_ 19
  - Tool support \_\_\_\_\_ 97
  - True power monitoring \_\_\_\_\_ 10, 12ff
  - Two-hand \_\_\_\_\_ 14, 30, 74
- ▶ **U**
  - Universal power supply \_\_\_\_\_ 11
- ▶ **V**
  - Voltage monitoring \_\_\_\_\_ 13



# Contact

## AT

Pilz Ges.m.b.H.  
Sichere Automation  
Modecenterstraße 14  
1030 Wien  
Austria  
Telephone: +43 1 7986263-0  
Telefax: +43 1 7986264  
E-Mail: [pilz@pilz.at](mailto:pilz@pilz.at)  
Internet: [www.pilz.at](http://www.pilz.at)

## AU

Pilz Australia  
Safe Automation  
Unit D7, Hallmarc Business park Clayton  
Corner of Westall and Centre roads  
Clayton, Melbourne, Victoria 3168  
Australia  
Telephone: +61 3 95446300  
Telefax: +61 3 95446311  
E-Mail: [safety@pilz.com.au](mailto:safety@pilz.com.au)  
Internet: [www.pilz.com.au](http://www.pilz.com.au)

## BE, LU

Pilz Belgium  
Safe Automation  
Bijenstraat 4  
9051 Gent (Sint-Denijs-Westrem)  
Belgium  
Telephone: +32 9 3217570  
Telefax: +32 9 3217571  
E-Mail: [info@pilz.be](mailto:info@pilz.be)  
Internet: [www.pilz.be](http://www.pilz.be)

## BR

Pilz do Brasil  
Automação Segura  
Av. Senador Vergueiro,  
347/355 -Jd. do Mar  
CEP: 09750-000  
São Bernardo do Campo - SP  
Brazil  
Telephone: +55 11 4126-7290  
Telefax: +55 11 4942-7002  
E-Mail: [pilz@pilz.com.br](mailto:pilz@pilz.com.br)  
Internet: [www.pilz.com.br](http://www.pilz.com.br)

## CA

Pilz Automation Safety Canada L.P.  
250 Bayview Drive  
Barrie, Ontario  
Canada, L4N 4Y8  
Telephone: +1 705 481-7459  
Telefax: +1 705 481-7469  
E-Mail: [info@pilz.ca](mailto:info@pilz.ca)  
Internet: [www.pilz.ca](http://www.pilz.ca)

## CH

Pilz Industrieelektronik GmbH  
Gewerbepark Hintermättli  
5506 Mägenwil  
Switzerland  
Telephone: +41 62 88979-30  
Telefax: +41 62 88979-40  
E-Mail: [pilz@pilz.ch](mailto:pilz@pilz.ch)  
Internet: [www.pilz.ch](http://www.pilz.ch)

## CN

Pilz Industrial Automation  
Trading (Shanghai) Co., Ltd.  
Rm. 1702-1704  
Yongda International Tower  
No. 2277 Long Yang Road  
Shanghai 201204  
China  
Telephone: +86 21 60880878  
Telefax: +86 21 60880870  
E-Mail: [sales@pilz.com.cn](mailto:sales@pilz.com.cn)  
Internet: [www.pilz.com.cn](http://www.pilz.com.cn)

## CZ, SK

Pilz Czech s.r.o.  
Safe Automation  
Zelený pruh 1560/99  
140 00 Praha 4  
Czech Republic  
Telephone: +420 222 135353  
Telefax: +420 296 374788  
E-Mail: [info@pilz.cz](mailto:info@pilz.cz)  
Internet: [www.pilz.cz](http://www.pilz.cz)

## DE

Pilz GmbH & Co. KG  
Felix-Wankel-Straße 2  
73760 Ostfildern  
Germany  
Telephone: +49 711 3409-0  
Telefax: +49 711 3409-133  
E-Mail: [info@pilz.de](mailto:info@pilz.de)  
Internet: [www.pilz.de](http://www.pilz.de)

## DK

Pilz Skandinavien K/S  
Safe Automation  
Ellegaardvej 25 L  
6400 Sønderborg  
Denmark  
Telephone: +45 74436332  
Telefax: +45 74436342  
E-Mail: [pilz@pilz.dk](mailto:pilz@pilz.dk)  
Internet: [www.pilz.dk](http://www.pilz.dk)

## ES

Pilz Industrieelektronik S.L.  
Safe Automation  
Camí Ral, 130  
Polígono Industrial Palou Nord  
08401 Granollers  
Spain  
Telephone: +34 938497433  
Telefax: +34 938497544  
E-Mail: [pilz@pilz.es](mailto:pilz@pilz.es)  
Internet: [www.pilz.es](http://www.pilz.es)

## FI

Pilz Skandinavien K/S  
Safe Automation  
Nuijamiestentie 7  
00400 Helsinki  
Finland  
Telephone: +358 10 3224030  
Telefax: +358 9 27093709  
E-Mail: [pilz.fi@pilz.dk](mailto:pilz.fi@pilz.dk)  
Internet: [www.pilz.fi](http://www.pilz.fi)

## FR

Pilz France Electronic  
1, rue Jacob Mayer  
CS 80012  
67037 Strasbourg Cedex 2  
France  
Telephone: +33 3 88104000  
Telefax: +33 3 88108000  
E-Mail: [siege@pilz-france.fr](mailto:siege@pilz-france.fr)  
Internet: [www.pilz.fr](http://www.pilz.fr)

## GB

Pilz Automation Ltd  
Pilz House  
Little Colliers Field  
Corby, Northants  
NN18 8TJ  
United Kingdom  
Telephone: +44 1536 460766  
Telefax: +44 1536 460866  
E-Mail: [sales@pilz.co.uk](mailto:sales@pilz.co.uk)  
Internet: [www.pilz.co.uk](http://www.pilz.co.uk)

## IE

Pilz Ireland Industrial Automation  
Cork Business and Technology Park  
Model Farm Road  
Cork  
Ireland  
Telephone: +353 21 4346535  
Telefax: +353 21 4804994  
E-Mail: [sales@pilz.ie](mailto:sales@pilz.ie)  
Internet: [www.pilz.ie](http://www.pilz.ie)

# Contact

## IN

Pilz India Pvt Ltd.  
Office No 202, Delite Square  
Near Aranyeshwar Temple  
Sahakar Nagar No 1  
Pune 411009  
India  
Telephone: +91 20 2421399-4/-5  
Telefax: +91 20 2421399-6  
E-Mail: [info@pilz.in](mailto:info@pilz.in)  
Internet: [www.pilz.in](http://www.pilz.in)

## IT

Pilz Italia S.r.l.  
Automazione sicura  
Via Gran Sasso n. 1  
20823 Lentate sul Seveso (MB)  
Italy  
Telephone: +39 0362 1826711  
Telefax: +39 0362 1826755  
E-Mail: [info@pilz.it](mailto:info@pilz.it)  
Internet: [www.pilz.it](http://www.pilz.it)

## JP

Pilz Japan Co., Ltd.  
Safe Automation  
Ichigo Shin-Yokohama Bldg. 4F  
3-17-5 Shin-Yokohama  
Kohoku-ku  
222-0033 Yokohama  
Japan  
Telephone: +81 45 471-2281  
Telefax: +81 45 471-2283  
E-Mail: [pilz@pilz.co.jp](mailto:pilz@pilz.co.jp)  
Internet: [www.pilz.jp](http://www.pilz.jp)

## KR

Pilz Korea Ltd.  
Safe Automation  
22F Keumkang  
Pentierum IT Tower Unit B  
810 Gwanyang-dong, Dongan-gu  
Anyang-si, Gyeonggi-do, 431-060  
South Korea  
Telephone: +82 31 450 0677  
Telefax: +82 31 450 0670  
E-Mail: [info@pilzkorea.co.kr](mailto:info@pilzkorea.co.kr)  
Internet: [www.pilz.co.kr](http://www.pilz.co.kr)

## MX

Pilz de México, S. de R.L. de C.V.  
Automatización Segura  
Convento de Actopan 36  
Jardines de Santa Mónica  
Tlalnepantla, Méx. 54050  
Mexico  
Telephone: +52 55 5572 1300  
Telefax: +52 55 5572 1300  
E-Mail: [info@pilz.com.mx](mailto:info@pilz.com.mx)  
Internet: [www.pilz.mx](http://www.pilz.mx)

## NL

Pilz Nederland  
Veilige automatisering  
Havenweg 22  
4131 NM Vianen  
Netherlands  
Telephone: +31 347 320477  
Telefax: +31 347 320485  
E-Mail: [info@pilz.nl](mailto:info@pilz.nl)  
Internet: [www.pilz.nl](http://www.pilz.nl)

## NZ

Pilz New Zealand  
Safe Automation  
Unit 4, 12 Laidlaw Way  
East Tamaki  
Auckland 2016  
New Zealand  
Telephone: +64 9 6345350  
Telefax: +64 9 6345352  
E-Mail: [office@pilz.co.nz](mailto:office@pilz.co.nz)  
Internet: [www.pilz.co.nz](http://www.pilz.co.nz)

## PL

Pilz Polska Sp. z o.o.  
Safe Automation  
ul. Ruchliwa 15  
02-182 Warszawa  
Poland  
Telephone: +48 22 8847100  
Telefax: +48 22 8847109  
E-Mail: [info@pilz.pl](mailto:info@pilz.pl)  
Internet: [www.pilz.pl](http://www.pilz.pl)

## PT

Pilz Industrieelektronik S.L.  
R. Eng Duarte Pacheco, 120  
4 Andar Sala 21  
4470-174 Maia  
Portugal  
Telephone: +351 229407594  
Telefax: +351 229407595  
E-Mail: [pilz@pilz.pt](mailto:pilz@pilz.pt)  
Internet: [www.pilz.pt](http://www.pilz.pt)

## RU

Pilz RUS OOO  
Ugreshskaya street, 2,  
bldg. 11, office 16 (1st floor)  
115088 Moskau  
Russian Federation  
Telephone: +7 495 665 4993  
E-Mail: [pilz@pilzrussia.ru](mailto:pilz@pilzrussia.ru)  
Internet: [www.pilzrussia.ru](http://www.pilzrussia.ru)

## SE

Pilz Skandinavien K/S  
Safe Automation  
Energigatan 10 B  
43437 Kungsbacka  
Sweden  
Telephone: +46 300 13990  
Telefax: +46 300 30740  
E-Mail: [pilz.se@pilz.dk](mailto:pilz.se@pilz.dk)  
Internet: [www.pilz.se](http://www.pilz.se)

## TR

Pilz Emniyet Otomasyon  
Ürünleri ve Hizmetleri Tic. Ltd. Şti.  
Kayışdağı Mahallesi Dudullu Yolu Cad.  
Mechun Sok. Duru Plaza No:7  
34755 Ataşehir/İstanbul  
Turkey  
Telephone: +90 216 5775550  
Telefax: +90 216 5775549  
E-Mail: [info@pilz.com.tr](mailto:info@pilz.com.tr)  
Internet: [www.pilz.com.tr](http://www.pilz.com.tr)

## TW

Pilz Taiwan Ltd.  
7F.-3, No. 146, Songjiang Rd.  
Zhongshan Dist., Taipei City  
104, Taiwan  
Telephone: +886 2 2568 1680  
Telefax: +886 2 2568 1600  
E-Mail: [info@pilz.tw](mailto:info@pilz.tw)  
Internet: [www.pilz.tw](http://www.pilz.tw)

## US

Pilz Automation Safety L.P.  
7150 Commerce Boulevard  
Canton  
Michigan 48187  
USA  
Telephone: +1 734 354 0272  
Telefax: +1 734 354 3355  
E-Mail: [info@pilzusa.com](mailto:info@pilzusa.com)  
Internet: [www.pilz.us](http://www.pilz.us)

# ► Support

Technical support is available from Pilz round the clock.

## Americas

**Brazil**

+55 11 97569-2804

**Canada**

+1 888-315-PILZ (315-7459)

**Mexico**

+52 55 5572 1300

**USA (toll-free)**

+1 877-PILZUSA (745-9872)

## Asia

**China**

+86 21 60880878-216

**Japan**

+81 45 471-2281

**South Korea**

+82 31 450 0680

## Australia

+61 3 95446300

## Europe

**Austria**

+43 1 7986263-0

**Belgium, Luxembourg**

+32 9 3217575

**France**

+33 3 88104000

**Germany**

+49 711 3409-444

**Ireland**

+353 21 4804983

**Italy**

+39 0362 1826711

## Scandinavia

+45 74436332

**Spain**

+34 938497433

**Switzerland**

+41 62 88979-30

**The Netherlands**

+31 347 320477

**Turkey**

+90 216 5775552

**United Kingdom**

+44 1536 462203

**You can reach our international hotline on:**

+49 711 3409-444

support@pilz.com

Pilz develops environmentally-friendly products using ecological materials and energy-saving technologies. Offices and production facilities are ecologically designed, environmentally-aware and energy-saving. So Pilz offers sustainability, plus the security of using energy-efficient products and environmentally-friendly solutions.



Presented by:



Pilz GmbH & Co. KG  
Felix-Wankel-Straße 2  
73760 Ostfildern, Germany  
Tel.: +49 711 3409-0  
Fax: +49 711 3409-133  
info@pilz.com  
www.pilz.com

