

*Inductive heating:
spot on, efficient, contact-free*

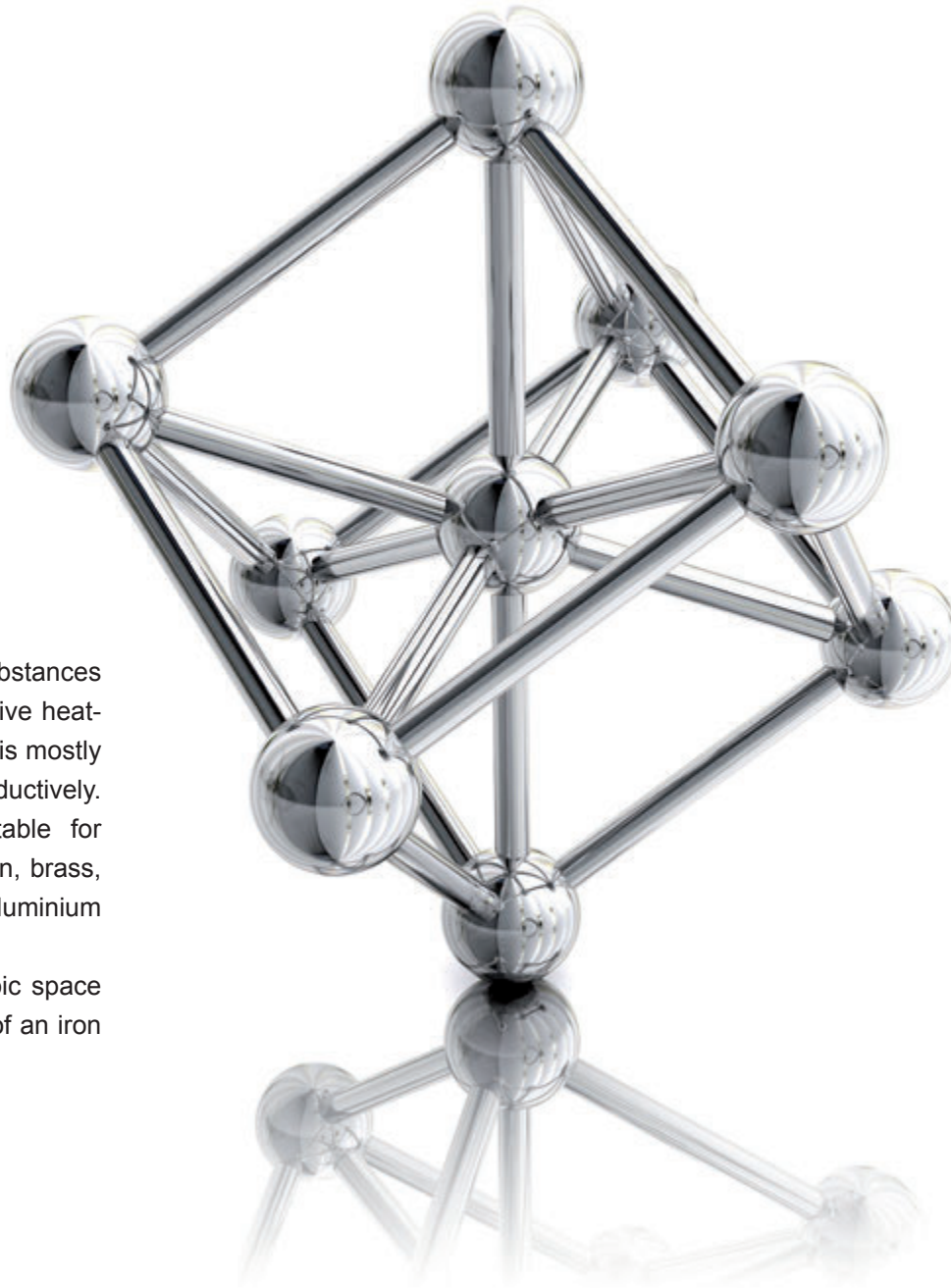



In theory all conductive substances can be heated with inductive heating, in practice however it is mostly metals that are heated inductively. Inductive heating is suitable for workpieces made from iron, brass, copper, stainless steel, aluminium and special alloys.

Shown here is the cubic space centered elementary cell of an iron crystal.

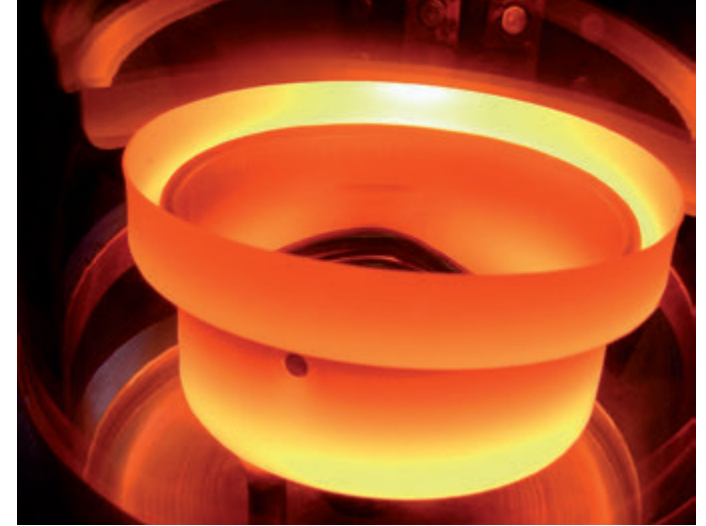

Electrically conductive bodies can be heated through extreme magnetic fields. That is known as inductive heating. [Latin: *inductio* = induction]. The setup in the laboratory is simple: Alternating current generates an electromagnetic field in a special inductor. Although the inductor does not touch it, an electrical voltage is also produced in the workpiece. This produces a) a current field that always runs in closed loops (eddy current) and b) alternating magnetic fields, which result in magnetic reversal occurring. Both cause the workpiece to heat up. The heat therefore develops in the body itself and does not need to be supplied externally through thermal conduction, convection or radiation. Consequently, inductive heating is particularly efficient – and safe!

Nature is a role model for us



Iron ore in its natural form. Iron – just as other metals – is well suited for processing with inductive heating.

Advantages of inductive heating

In contrast to conventional methods (e.g. furnaces) inductive heating can be controlled very precisely.

The heat can also be supplied faster. There does not have to be any direct contact, this method is also suitable for heating workpieces that are already installed. Inductive heating systems offer a number of advantages: They require much less space than furnaces. Since no open flames are used and the method itself does not produce any fumes, the working conditions are therefore better than with conventional methods.

These facts make the process interesting for industry, trade and science.



With inductive heating, ferromagnetic materials are heated through magnetic reversal losses and eddy current losses. In non-magnetic materials (e.g. copper, aluminium, brass, stainless steel) only eddy current losses have any effect.

The advantages at a glance:

- contact-free heating
- less space required
- high level of efficiency
- exact temperature control
- system immediately operable

Inductive heating system

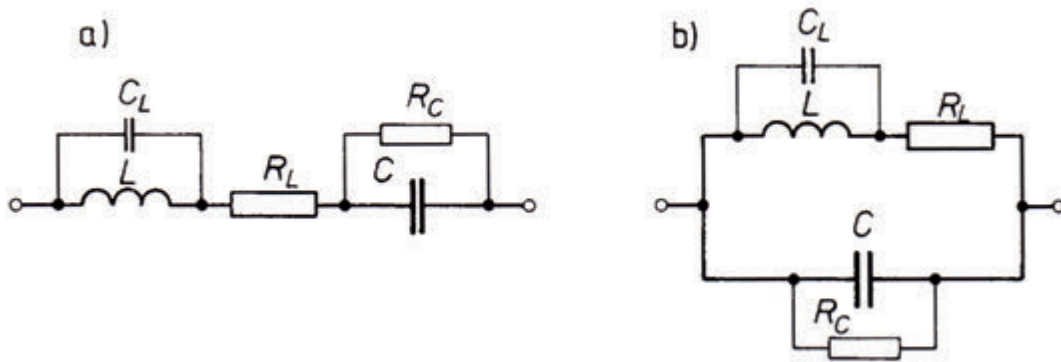

An induction heating system consists of a frequency transformer (also called frequency generator) and a resonant circuit for generating a current or voltage resonance. a) diagram of a resonant circuit in series b) diagram of a parallel resonant circuit.

The design of an inductive heating system always follows the same principle: It consists of an alternating current generator and a heating station with the inductor. When the equipment is in use, it can be monitored continuously and controlled precisely with the temperature control. On request, the system can also be equipped with a programmable logic controller (PLC) with an infrared pyrometer instead of the temperature control. One can control the induction system either manually or by means of an automatic timer.

Left: power connection

Middle: indicators for monitoring

Right: operating elements with potentiometer



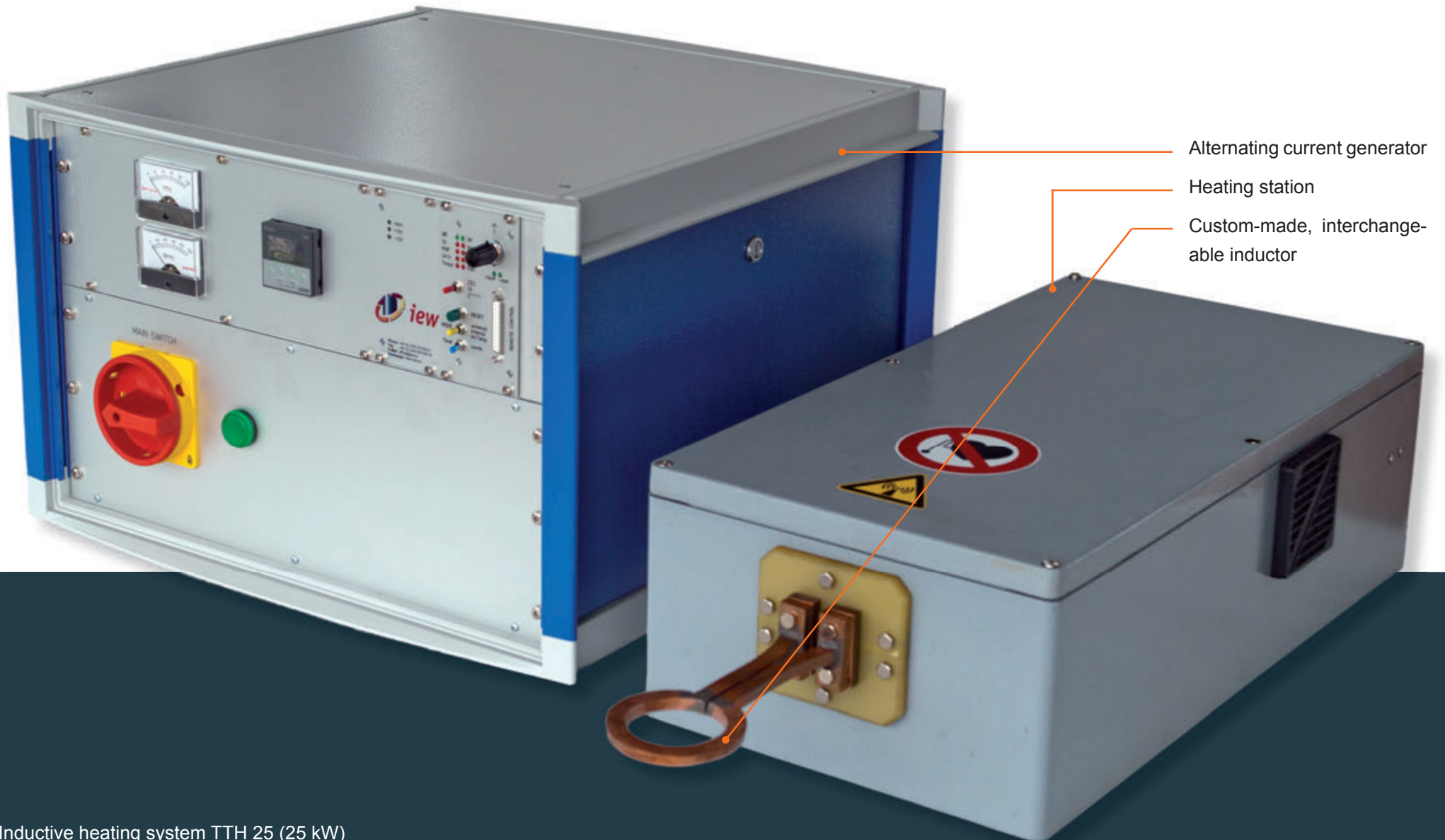

Inductive heating system TTH 25 (25 kW)

What would you like?

*Mobile or stationary? Suitable for clock- or continuous operation?
With a special inductor?*

Production according to individual customer requirements and manual production are of course a matter of our inductive heating systems! Because system and inductor are always adapted to the field of application, they can be integrated into the production process without any problems.

Here we give you an overview of our production: Custom inductor production according to customer requirements demands a high level of skill and a lot of experience.



Custom-made inductor with water cooling

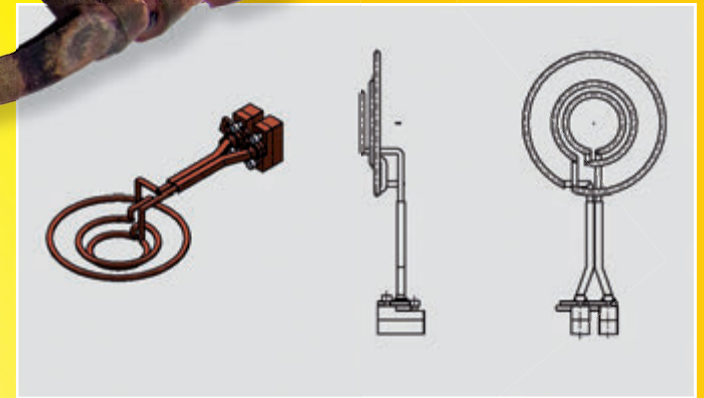

Inductor Design

Only when the inductor is constructed optimally can workpieces of the best possible quality be manufactured with it. The form is therefore adapted exactly to the workpiece and the system performance.

At first we determine the optimal characteristics of the inductor in laboratory tests. The perfect inductor is then designed with a CAD program and manufactured and tested by specialists in our inductor workshop.

Inductors can be changed quite simply with just a few hand movements. Consequently the induction system can be converted to another workpiece in a very short time. As a result, the induction system can be implemented flexibly in the production and utilize it optimally.



Large picture: new production in Gumpoldskirchen
Left: Dipl.-Ing. Martin Schweikhart
Middle: CAD workplace for the plant design
Right: Every component is manufactured by specialists

Experts for every case of inductive heating

We are experts for all types of heat treatment with induction heating systems. We have been developing and constructing devices and systems for inductive heating since 1996. At that time Dipl.-Ing. Martin Schweikhart started the one-man business. Just one year later he was able to transform the engineering office into iew Induktive Erwärmungsanlagen GmbH.

iew rapidly developed to a successful manufacturer of heating systems for industry, trade and science. Today we are at the forefront of small and medium-sized induction heating systems.

So that growth is not slowed we opened our new company building in Gumpoldskirchen, south of Vienna, in 2008. We deliver our inductive heating systems throughout the world from here.

Fields of application for inductive heating

- Soldering and brazing
- Hardening
- Annealing
- Tempering
- Shrink technology
- Bonding
- Welding
- Smelting
- Continuous heating
- Material testing
- Inert gas- and vacuum technology
- Special applications according to customer requirements
- Science

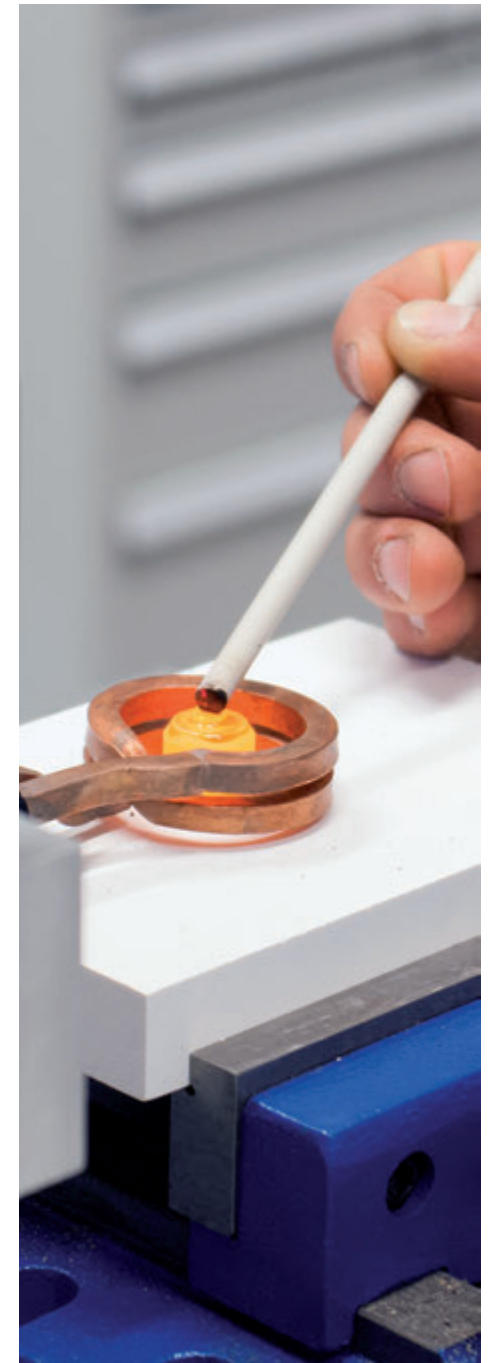

Inductive brazing

Metals can be soldered and brazed with inductive heating. Due to the special adaptability it is possible to bond magnetic and non-magnetic components together – for example: steel, copper, brass or aluminium. The precise temperature control of the inductive heating system also represents an unbeatable advantage with this method. Freely definable heating zones, short heating and cooling times are additional advantages.



For the industry we develop serial brazing systems which can produce several million components a year. So that we can perfectly coordinate the system, we must understand the product. To this end we first produce prototypes on our test systems in the test and development laboratory. (picture left) The entire production process of the module is analyzed by us. With this knowledge the customer can design the module suitable for brazing. The result is a unique serial brazing system for maximum productivity and quality.

Inductive brazing with inert gas

Special materials or fields of application demand special processing. The flux used for conventional brazing is frequently the cause of corrosion and scorch marks on the workpiece. Both problems can be avoided by brazing with inert gas. Apart from that discoloration that occurs on the workpiece due to the oxygen in the atmosphere. This is also avoided with inert gas.

The inert gas process can be combined very well with inductive heating, because there is no open flame during the inductive heating process with inert gas and the technical flow conditions can be better controlled.



Every brazing application is a particular challenge, which often demands a tailored solution. This example application from the automotive sector shows a round index table for inductive brazing under an inert gas atmosphere. As a result one can dispense with any flux and this way prevent corrosion in the brazing joint. Consequently the service life of the component is extended. Production time would have been lost due to the preliminary flooding and reflooding of the inert gas atmosphere. We have compensated for that by designing the system so that several workpieces can be brazed at the same time. Through this our inductive brazing system increases the productivity.

Inductive hardening system IHU 25



Inductive hardening

During hardening, the metal is heated to over 900 °C. As a result the structure of the material is modified: It becomes harder, its tensile strength and resistance to deformation are increased.

With inductive heating the entire heating process is controlled precisely. Therefore, the desired effects can be limited to certain areas of the workpiece. The material properties of your components are thus adapted exactly to the demand. Hardness and elasticity – both are possible.

We have developed a variety of solutions for inductive hardening. For example the hardening system IHU 25 pictured above. Metal workpieces can be hardened, tempered or annealed with this system, stationary or at a feed rate. The system works semi-automatically and can be operated comfortably by one person, whereby special attention was placed on the optimization of the work sequences. As a result, our inductive heating system integrates seamlessly into the production process and thus helps to save time and money.





Inductive heating system TTH5 (5 kW)

Inductive shrinking

During shrinking two workpieces (e.g. gearwheel, unbalance mass, shaft, etc.) are joined in a force-fit manner. For this, one utilizes the property that metals expands when heated. For example: A gearwheel is heated up until the bore is larger than the outside diameter of the shaft. The shaft can now be pushed into the gearwheel; a force-fit connection is produced when the components cool down. This process is even more efficient with inductive heating: The components can be heated to the required temperature in just a few seconds.

Our solutions for shrink fitting are applied in a variety of ways. For example to connect gearwheels in an automobile plant or – a very classic application – to connect a component with a shaft. For a product from the automobile branch two unbalance masses and one gearwheel must be shrunk onto a shaft. The components are thereby heated simultaneously to approx. 180° C with a multi-winding mandrel inductor. Our TTH5 inductive heating system manages this in just 20 seconds! Due to the short heating phase the productivity of the plant is increased significantly.



Employed for science and material testing

An inductive heating system in a test setup of the University of Bielefeld.

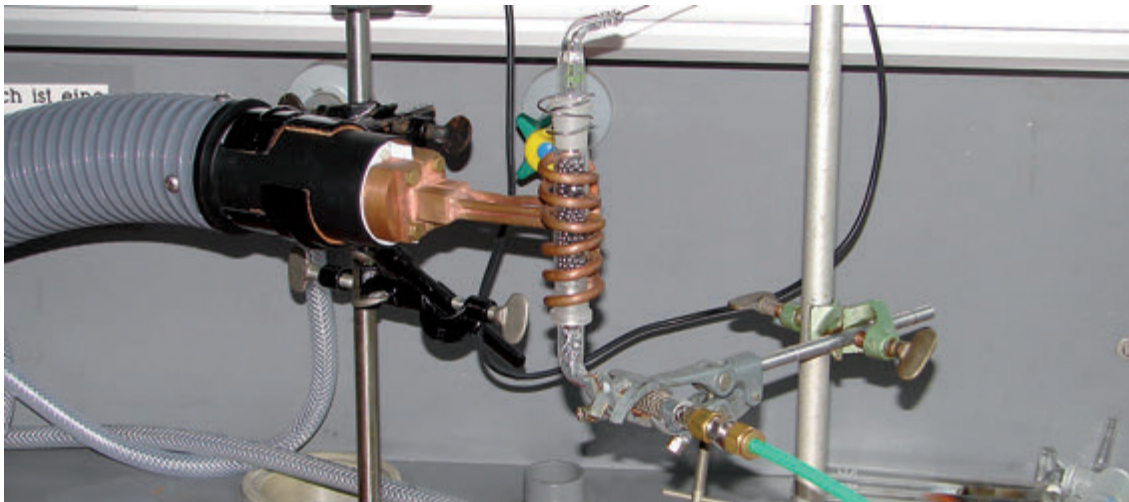

Since the founding of our company we have had a close relationship to science ever since. In the meantime we are able to count many colleges and research institutes among our clientele.

E.g. inductive heating is used for direct or indirect material testing or the development of new production processes. In testing technology one also profits from the rapid heating and the constant temperature that is possible with inductive heating.

Due to its modest space requirement, an induction system can be integrated in a variety of test fixtures. Other than with fixed installed ovens, an induction system can be transported simply from one laboratory to another without much preparation. The induction system can also heat the test specimen with inert gas or under vacuum without a lot of conversion work.

A workpiece is heated with inductive heating in a test workshop of the Montanuniversität Leoben.



Service & Support

We also provide a range of services for all our inductive heating systems. Consequently, with us you get everything from one provider: Planning, system design, implementation and support during continuous operation.

- We already support you in the planning phase with comprehensive consultation for the conception.
- We implement our systems in your production process. Thereby, we adapt the system to your requirements and specifications.
- For operation we offer you Service & Support. When the rare case of a fault occurs, we are at your disposal and rectify the fault.

Your benefits: With our additional service offer you protect your investment. And you ensure, that you are always at the cutting edge of technology.



Advantage through iew induction heating technology!



iew Induktive Erwärmungsanlagen GmbH
Novomaticstr. 16 • 2352 Gumpoldskirchen • Austria
T +43 2252 607 000-0 • F +43 2252 607 000-20
E office@iew.eu • www.iew.eu

www.induktionserwaermung.eu
www.inductionheating.eu

