



Over 40 new entrance door styles



Aluminium Entrance Doors

Elegant design, highest thermal insulation



The best choice for your home
Hörmann aluminium entrance doors



Find your favourite door

All styles at a glance

ThermoSafe



Style 40
Page 31

// NEW



Style 45
Page 21



Style 65
Page 20



Style 75
Page 21

// NEW



Style 110
Page 25

// NEW



Style 136
Page 25

// NEW



Style 140
Page 25

// NEW



Style 166
Page 25

// NEW



Style 185
Page 23

// NEW



Style 188
Page 42



Style 402
Page 33

// NEW



Style 413
Page 33

// NEW



Style 449
Page 32

// NEW



Style 501
Page 23



Style 502
Page 23



Style 503
Page 22



Style 551
Page 26

// NEW



Style 552
Page 27

// NEW



Style 553
Page 28

// NEW



Style 554
Page 31

// NEW



Style 555
Page 30

// NEW

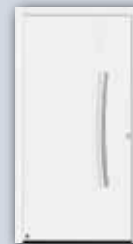

Style 556
Page 39

// NEW



Style 557
Page 39

// NEW



Style 558
Page 31

// NEW



Style 565
Page 36

// NEW



Style 568
Page 34

// NEW



Style 581
Page 27

// NEW



Style 583
Page 29

// NEW



Style 585
Page 29

// NEW



Style 590
Page 29

// NEW



Style 650
Page 17



Style 659
Page 19

// NEW



Style 680
Page 17



Style 686
Page 17



Style 689
Page 19

// NEW



Style 693
Page 41

// NEW



Style 694
Page 33

// NEW



Style 697
Page 19



Style 860
Page 16

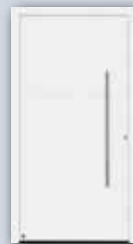

Style 861
Page 41

// NEW

The colours and surface finishes shown are subject to the limitations of the printing process and cannot be regarded as binding. Some of the products and equipment details described and illustrated in this catalogue are not standard, but available for a surcharge depending on the equipment option. Descriptions and pictures, information about the scope of delivery, equipment and colour correspond to the time of printing.

ThermoCarbon

TopComfort



Style 173
Page 43
// NEW



Style 177
Page 23
// NEW



Style 300
Page 45
// NEW



Style 301
Page 45
// NEW



Style 302
Page 45
// NEW



Style 100
Page 49



Style 101
Page 49

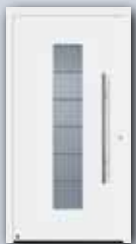

Style 504
Page 22



Style 505
Page 21



Style 304
Page 47



Style 305
Page 46



Style 306
Page 47

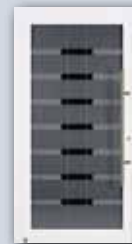

Style 100
MG 111
Page 50



Style 100
MG 112
Page 50



Style 559
Page 27
// NEW



Style 560
Page 27



Style 308
Page 44



Style 310
Page 47



Style 311
Page 46



Style 100
MG 113
Page 51



Style 100
MG 114
Page 50



Style 667
Page 19



Style 675
Page 33
// NEW



Style 312
Page 45



Style 314
Page 47



Style 650
Page 17



Style 100
MG 115
Page 50



Style 100
MG 116
Page 51



Styles
825 / 845 / 855
Page 40
// NEW



Styles
875 / 895 / 898
Page 40
// NEW



Style 680
Page 17



Style 686
Page 17



Style 860
Page 16



Style 100
MG 117
Page 51
// NEW

Subject to changes and errors.
Please contact your Hörmann Partner with reference to the current price list for specific door equipment.
All rights reserved. No part may be reproduced without our prior permission.

“A good reputation must be earned”.

(August Hörmann)

In keeping with the tradition started by the company's founder, the name Hörmann delivers brand name quality with extensive expertise. The family business has over 75 years of experience as a construction component specialist and sees itself as your partner from the very beginning of building and renovation projects. No surprise then, that Hörmann is one of Europe's most successful entrance door providers. All of this gives you a good feeling when you purchase a Hörmann entrance door.

Quality products from Germany

The entrance door construction is developed and manufactured by Hörmann. Our highly qualified employees work intensively on new products, continual further developments and improvements to details. Patents and unique products on the market are the result of this. Endurance tests under real conditions ensure mature series products with Hörmann quality.

CE mark in accordance with EN 14351-1

The CE mark confirms compliance with and observance of the principal requirements of the product standard EN 14351-1 for all of our entrance doors.

Entrance doors for generations

We are convinced of our products and our uncompromising quality assurance. That is why we issue a 10-year guarantee* on all Hörmann aluminium entrance doors.



An eye on the future

Hörmann is setting a good example. This is why, since 2013, the company has obtained 40 % of its required energy from green sources and will continue to increase this percentage. At the same time, many tonnes of CO₂ are saved each year thanks to the introduction of an intelligent and certified energy management system. And last but not least, Hörmann also offers products for sustainable construction. Find out more about Hörmann's environmental activities in the “We think green” brochure.

* The complete warranty conditions can be found at: www.hoermann.com

Design overview	3
Brand quality from Hörmann	5
Good reasons to try Hörmann	6
ThermoSafe and ThermoCarbon product features	
Door construction	8
Exterior door view	10
Interior door view	12
Security features	14
Door styles	
ThermoSafe	16
ThermoCarbon	44
TopComfort	48
Features tailored to your needs	
Glazings	54
Colours	56
Handles	58
RC security features	60
Lock variants	62
Canopies	64

Aluminium offers everything!

Because aluminium doors are superior to plastic or timber doors in many ways. The advantages:

- Excellent thermal insulation
- High security
- High acoustic insulation
- High stability
- No follow-up painting necessary

Aluminium doors look new for years, and also offer you a large variety of options in regard to technical equipment and design.

ThermoSafe aluminium entrance door

If you want high thermal insulation and security for your home, we recommend our ThermoSafe door.

For more about ThermoSafe doors, see pages 8 – 14.

ThermoCarbon aluminium entrance door

Do you value excellent thermal insulation and the highest security? Then our ThermoCarbon entrance door is the perfect choice for you.

More benefits of the ThermoCarbon can be found on pages 8–14.

TopComfort aluminium entrance door

Thanks to its extensive glazing, the TopComfort entrance door complies with all your demands for maximum light.

Discover all the possibilities from page 48.

Good reasons to try Hörmann

Innovations from the market leader



ThermoCarbon aluminium entrance doors with a U_D -value of up to $0.47 \text{ W}/(\text{m}^2\cdot\text{K})^*$



1

Door leaf without visible leaf profile

2

Highest thermal insulation

The ThermoSafe and ThermoCarbon entrance doors give you an exquisite and elegant reception. The shapely door leaf with its solid interior and exterior and leaf profile on the inside fulfils the highest design requirements. The interior view harmonises perfectly with the residential internal doors of your home.



The door interior looks like a residential internal door (Pictured: ThermoSafe entrance door)

ThermoSafe and ThermoCarbon entrance doors are the new generation of high-insulation entrance doors. ThermoSafe fulfils all the requirements of a low-energy house with excellent thermal values and triple thermal insulated glazing. ThermoCarbon entrance doors up the ante: with flush-fitting, 100-mm-thick door leaf, thermal break thanks to carbon glass-fibre, standard triple or quadruple thermal insulated glazing and triple sealing, they also provide maximum thermal insulation for low-energy house construction.

ThermoSafe
 U_D -value of up to $0.8 \text{ W}/(\text{m}^2\cdot\text{K})^*$

ThermoCarbon
 U_D -value of up to $0.47 \text{ W}/(\text{m}^2\cdot\text{K})^*$

* Door size $1250 \times 2200 \text{ mm}$
(the U_D -value is dependent on the door size)



3

Break-in-resistant locking

Our ThermoSafe and ThermoCarbon entrance doors set new standards for security. All doors are equipped with multiple-point locking as standard. This means the hinge side is better protected against forced opening.

You can also opt for ThermoSafe and ThermoCarbon entrance doors, side elements and transom lights with break-in resistant RC features – giving you and your family more security.



For further information, please see page 60.

4

Safe glazing



Accident prevention and break-in protection come first: ThermoSafe and ThermoCarbon entrance doors fulfil the highest demands of design and security. The 8-mm-thick laminated safety glass on the interior and exterior of the insulated glazing provides maximum security. In case of breakage, the glass splinters are bound and stay adhered to the plastic film on the inside, ensuring that there is no danger of being injured by the shards. Furthermore, the laminated safety glass offers better protection against burglars, because it makes reaching through more difficult.

Thanks to a highly insulated edge compound with thermal break (warm edge), the glazing offers high thermal insulation for effective energy saving and high acoustic insulation for more peaceful living conditions.

ThermoSafe aluminium entrance door

Door construction

With a 73-mm-thick door leaf, the ThermoSafe entrance doors fulfil all requirements for low-energy houses and the new EnEV 2014. The door construction is particularly suitable for installations without thermal bridges and provides a range of benefits:

- [1] Solid 73 mm aluminium door leaf with PU rigid foam infill and internal leaf profile
- [2] Aluminium leaf profile with thermal break
- [3] 80 mm aluminium door frame with thermal break
- [4] Double sealing with an all-round seal

Especially high thermal insulation

**U_D -value up to
0.8 W/(m²·K)**

Approved by IFT Rosenheim
Door size 1250 × 2200 mm

Full-scale

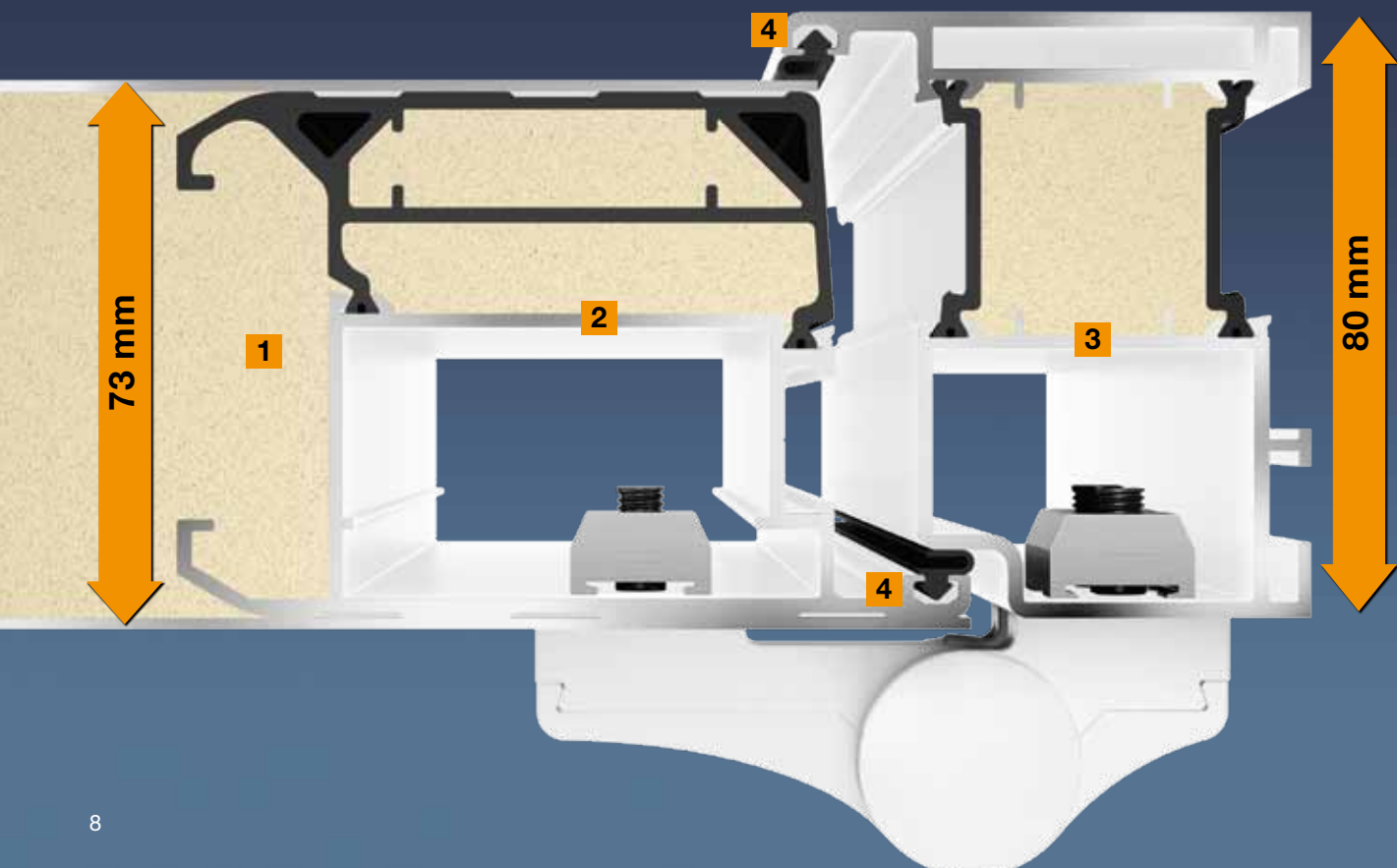

ThermoCarbon aluminium entrance door

Door construction

Thanks to a 100-mm-thick door leaf, the ThermoCarbon entrance doors are ideal for low-energy houses and fulfil all requirements of the new EnEV 2014. The door construction is particularly suitable for installations without thermal bridges and provides excellent benefits:

- [1] Solid 100 mm aluminium door leaf with PU rigid foam infill and internal leaf profile
- [2] Thermal break and high stability thanks to carbon glass-fibre reinforced composite leaf profile
- [3] 111 mm aluminium door frame with thermal break
- [4] Triple sealing with two all-round seals

Excellent thermal insulation

**U_D -value
of up to
0.47 W/(m²·K)**

Approved by IFT Rosenheim
Door size 1250 × 2200 mm

Full-scale

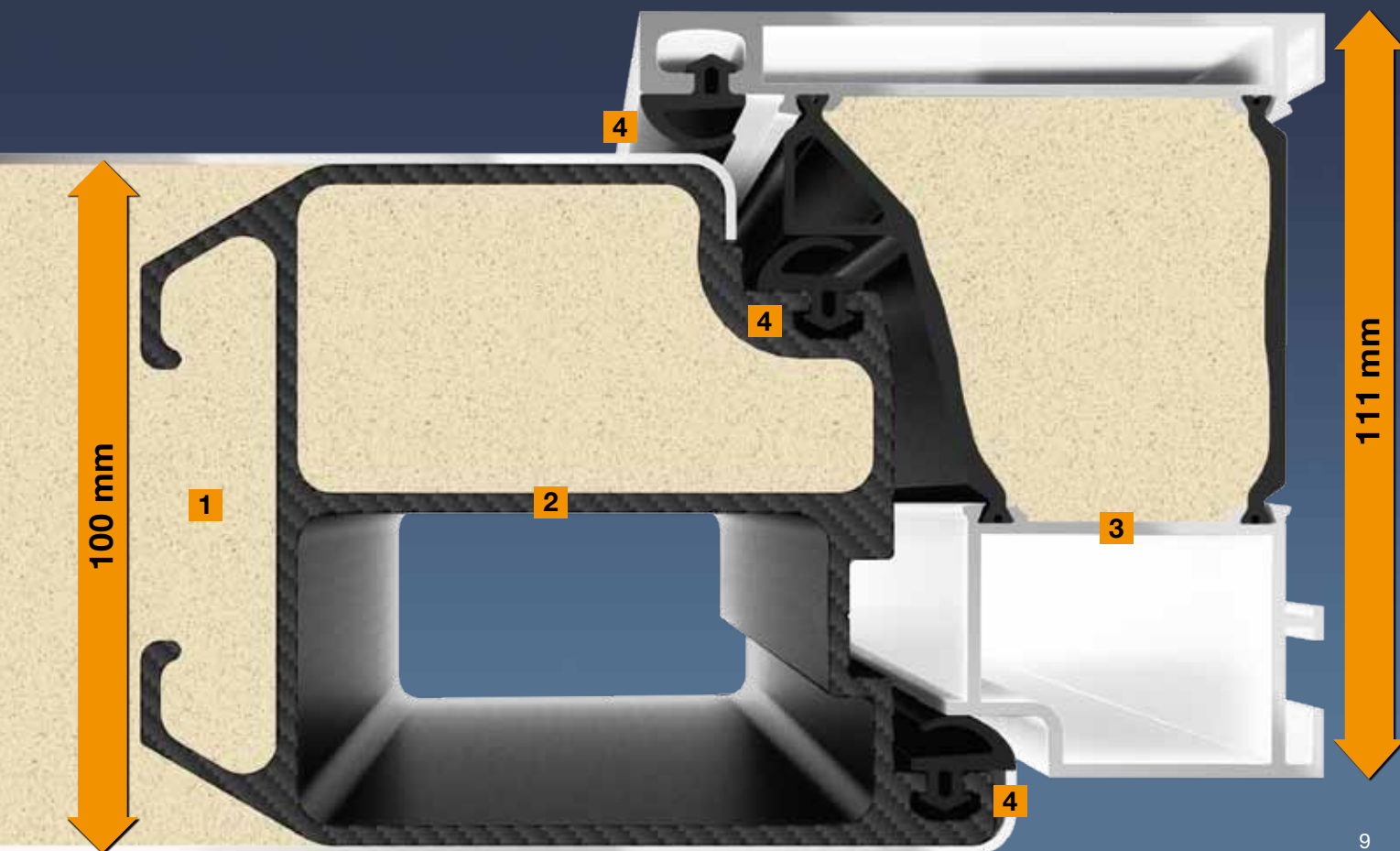

ThermoSafe aluminium entrance door

Exterior door view



With stylish, coordinated design elements, the ThermoSafe aluminium entrance door is visually impressive across the board:

Solid interior and exterior door leaf view

No visible door profile interrupts the look of the door. This means the entrance door looks generously proportioned from the outside, while the interior view harmonises perfectly with your residential internal doors.

Door frame with 70 mm profile view

(not shown)

Standard for fitting in the opening.

Optional frame variants for an individual look

Broader door frames

On request, door frames are also available in a width of 110 mm, for a more convenient and attractive connection to full thermal insulation, for example.

Fascia frame Rondo 70

The rounded frame profile adds a stylish touch to your entrance door, providing it with a particularly harmonious look with its rounded edges.

Fascia frame Caro 70

This version has an attractive and distinguished look that upgrades the appearance of your door through the frame's added appearance of depth.



Broader door frame with 110 mm profile view



Fascia frame Rondo 70



Fascia frame Caro 70

ThermoCarbon aluminium entrance door

Exterior door view



The ThermoCarbon aluminium entrance door offers you individual design possibilities and protects your home, making it not only secure, but also stylish:

Solid interior and exterior door leaf view

No visible door profile interrupts the look of the door. This means the entrance door looks generously proportioned from the outside, while the interior view harmonises perfectly with your residential internal doors.

Door frame with 100 mm profile view (not shown)

Suitable for a convenient and attractive connection to the full thermal insulation. Standard for fitting in the opening.

Flush-fitting exterior handles for exclusive door styles

Stainless steel handle with recessed grip
Doors with a stainless steel handle come as standard with a recessed grip in the colour of the door.

Continuous aluminium handle bar
As standard, the complete handle bar is supplied in White aluminium, RAL 9006, with a recessed grip in the colour of the door.

Aluminium handle bar with recessed grip
As standard, this handle bar comes in White aluminium, RAL 9006, with a recessed grip in the colour of the door.

Discover the individual colour options for flush-fitting exterior handles on page 59.



Stainless steel handle with recessed grip



Continuous aluminium handle bar



Aluminium handle bar with recessed grip

ThermoSafe aluminium entrance door

Interior door view



Quality is in the details. The ThermoSafe offers numerous features, all of which are practical and convenient for your home:

3-way adjustable hinges

The beautifully designed three-way hinges allow the ThermoSafe entrance door to be variably adjusted. This way, your entrance door is optimally sealed and falls smoothly and securely into its lock. You can also opt for elegant, concealed hinges (incl. leverage protection).

Tamper-proof profile cylinder

The profile cylinder is equipped with an anti-picking system and drill protection. In addition, it offers an emergency and hazard function, i.e. the door lock can still be operated when a key is inserted on the inside. The tamper-proof locking cylinder is certified according to DIN 18252 / DIN EN 1303 and is delivered with 5 reversible keys.

Aluminium interior lever

ThermoSafe entrance doors are equipped as standard with the attractive Rondo interior lever, stove-enamelled in white. Optionally, it is also available in stainless steel or your choice of RAL as well as the versions Caro or Okto, also in stainless steel.

Stainless steel lock plates

The lock plates ensure a convenient adjustment of the door, so that your door falls shut optimally and can be closed securely.

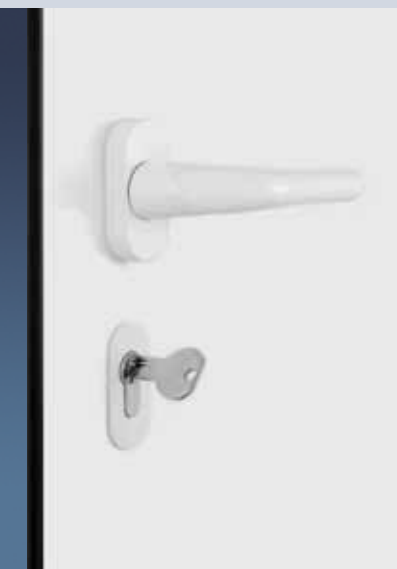

Aluminium interior lever



Stainless steel lock plates

ThermoCarbon aluminium entrance door

Interior door view



The ThermoCarbon is not only unsurpassed for thermal insulation and security, the door's features offer you everything you want and more:

Concealed hinges

The hinges of the ThermoCarbon entrance door are concealed between the door frame and leaf, i.e. they are not visible either from inside or outside: a visually elegant solution for your home. The door leaves can be simply and easily adjusted. This way, you can close your entrance door comfortably and securely at all times.

Tamper-proof profile cylinder

The tamper-proof profile cylinder, certified in accordance with DIN 18252 / DIN EN 1303, features premium fittings: an anti-picking system, drill protection, and an emergency and hazard function. This means that the door lock can still be operated when a key is inserted on the inside. 5 reversible keys are delivered with the door.

Stainless steel interior lever

The elegant Caro stainless-steel interior lever is standard for ThermoCarbon entrance doors.

Continuous stainless steel closing strip

The high-quality stainless steel closing strip is elegantly integrated into the door frame. This enables optimum adjustment of the door and allows for secure locking at all times.



Stainless steel interior lever



Continuous stainless steel closing strip

ThermoSafe aluminium entrance door

Security features



Available from
autumn 2014



Being able to rest easy in your own home is important. This is why the ThermoSafe entrance doors are equipped with multiple-point locking as standard.

5-point security lock H5 and security bolts on the hinge side

When locking, 3 steel swing bolts with 2 additional bolt locks pivot into the stainless steel lock plates. The swing bolts make pulling apart or forcing open the door more difficult.

Exterior surface-mounted security rose escutcheon

The patented exterior rose escutcheon also protects the profile cylinder against being drilled open and twisted off. Delivered as standard in Traffic white RAL 9016, or in stainless steel for coloured doors.

Optional: break-in resistant RC security features

This increased security is available for entrance doors, side elements and transom lights with RC 2 and RC 3 features. For further information, please see page 60.



Surface-mounted security
rose escutcheon



Security bolts



H5 5-point security lock
with stainless steel lock cover.

ThermoCarbon aluminium entrance door

Security features



Available from
autumn 2014

Available from
winter 2014



ThermoCarbon aluminium entrance doors are the best in their class in terms of security. Standard equipment with the H9 security lock offers you the best protection. Only from Hörmann: RC 4 security equipment is optionally available for even more safety.

9-point H9 security lock and concealed hinges that cannot be forced open

The ThermoCarbon comes with 9-point security. When locking, 5 steel swing bolts and 4 bolt locks pivot into the stainless steel lock plates. This top security protects your door with just one turn of a key.

Exterior flush-fitting security rose escutcheon

The stainless steel security rose escutcheon fits into the door leaf particularly elegantly, and also protects the profile cylinder against being drilled open.

Optional: break-in resistant RC security features

This increased security is available for entrance doors and side elements with RC 2, RC 3 and RC 4 features. For further information, please see page 60.



Flush-fitting security rose escutcheon



Concealed hinges that cannot be forced open



H9 9-point security lock with continuous stainless steel lock cover

Discover your new entrance door

A programme that offers you a lot of options



Style 860

Stainless steel handle HOE 700

Side element

Ornamental glass infill,
triple thermal insulation glass

Door versions

- **ThermoSafe**
 U_D -value of up to $0.8 \text{ W}/(\text{m}^2\cdot\text{K})^*$
- **ThermoCarbon**
 U_D -value $0.50 \text{ W}/(\text{m}^2\cdot\text{K})^*$

ThermoSafe **style 680**
In preferred colour Slate grey, matt, RAL 7015, with side element
and L-ribbed sectional garage door, Silkgrain in Slate grey, RAL 7015



ThermoSafe **style 860**
Traffic white, matt, RAL 9016



ThermoCarbon **style 860**
In preferred colour Ruby red, matt,
RAL 3003



ThermoCarbon **style 686**
In preferred colour Window grey,
matt, RAL 7040

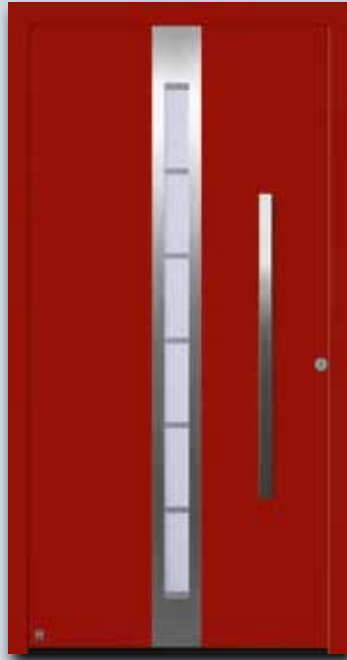

ThermoSafe **style 686**
In preferred colour Ruby red, matt,
RAL 3003



ThermoCarbon **style 680**
Traffic white, matt, RAL 9016



ThermoSafe **style 650**
in Hörmann colour CH 703

Style 686

Stainless steel handle HOE 600,
stainless steel embellishment, matt float
design glass with 7 clear stripes,
triple / quadruple thermal insulation glass

MG 686 side element

Design glass, matt float with 7 clear
stripes, triple insulation glass

Door versions

- **ThermoSafe**
U_D-value of up to 0.9 W/(m²·K)*
- **ThermoCarbon**
U_D-value 0.55 W/(m²·K)*

Style 680

Stainless steel handle HOE 700,
stainless steel embellishment,
Pave white ornamental glass,
triple / quadruple thermal insulation glass

Side element

Ornamental glass infill,
triple thermal insulation glass

Door versions

- **ThermoSafe**
U_D-value of up to 0.9 W/(m²·K)*
- **ThermoCarbon**
U_D-value 0.57 W/(m²·K)*

Style 650

Stainless steel handle HOE 700,
Pave white ornamental glass,
triple / quadruple thermal insulation glass

Side element

Ornamental glass infill,
triple thermal insulation glass

Door versions

- **ThermoSafe**
U_D-value of up to 0.9 W/(m²·K)*
- **ThermoCarbon**
U_D-value 0.57 W/(m²·K)*

* Door size 1230 × 2180 mm

Straight lines, elegant glass

Sand-blasted with clear horizontal stripes





ThermoSafe **style 667**
Traffic white, matt, RAL 9016



ThermoSafe **style 697**
In Hörmann colour CH 703
with fascia frame Rondo 70



ThermoSafe **style 659**
Traffic white, matt, RAL 9016



ThermoSafe **style 689**
In preferred colour Ruby red, matt,
RAL 3003

Style 667

Stainless steel handle HOE 910,
matt Parsol grey design glass
with 7 clear stripes,
triple thermal insulation glass

MG 667 side element

Design glass infill, matt Parsol grey
with 7 clear stripes,
triple thermal insulation glass

Door version

- **ThermoSafe**
U_D-value of up to 0.9 W/(m²·K)*

Style 697

Stainless steel handle HOE 910,
stainless steel embellishments, matt
Parsol grey design glass with 7 clear
stripes, triple thermal insulation glass

MG 697 side element

Design glass infill, matt Parsol grey
with 7 clear stripes,
triple thermal insulation glass

Door version

- **ThermoSafe**
U_D-value of up to 0.9 W/(m²·K)*

Style 659

Stainless steel handle 38-2, stainless
steel embellishment, matt Parsol grey
design glass with 7 clear stripes, triple
thermal insulation glass

Side element MG 659

Design glass infill, matt Parsol grey
with 7 clear stripes,
triple thermal insulation glass

Door version

- **ThermoSafe**
U_D-value of up to 0.9 W/(m²·K)*

Style 689

Stainless steel handle 38-2, stainless
steel embellishment, matt Parsol grey
design glass with 7 clear stripes, triple
thermal insulation glass

Side element MG 689

Design glass infill, matt Parsol grey
with 7 clear stripes,
triple thermal insulation glass

Door version

- **ThermoSafe**
U_D-value of up to 0.9 W/(m²·K)*

* Door size 1230 × 2180 mm

Setting accents with Hörmann

Elegant look, inventive glazing cut-outs



ThermoSafe **style 75**
In Traffic white, matt, RAL 9016, with side element

Style 65

Stainless steel handle HOE 600,
stainless steel embellishment,
matt float design glass with 7 clear stripes,
triple thermal insulation glass

Side element MG 65

Design glass, matt float
with 7 clear stripes, triple insulation glass

Door version

- **ThermoSafe**

U_D -value of up to $0.9 \text{ W}/(\text{m}^2 \cdot \text{K})^*$



ThermoSafe **style 65**
In Traffic white, matt, RAL 9016, with MG 65 side elements



ThermoSafe **style 75**
Traffic white, matt, RAL 9016

Style 75

Stainless steel handle 38-1,
stainless steel embellishment,
ornamental glass Mastercarré,
triple thermal insulation glass

Side element

Ornamental glass infill,
triple thermal insulation glass

Door version

- **ThermoSafe**

U_D -value of up to 0.9 W/(m²·K)*

Style 45

Stainless steel handle HOE 200,
stainless steel embellishment,
matt Parsol grey design glass
with 4 clear stripes,
triple thermal insulation glass

Side element MG 45

Design glass infill, matt Parsol grey
with 4 clear stripes,
triple thermal insulation glass

Door version

- **ThermoSafe**

U_D -value of up to 0.9 W/(m²·K)*



ThermoSafe **style 45**
in Hörmann colour CH 703

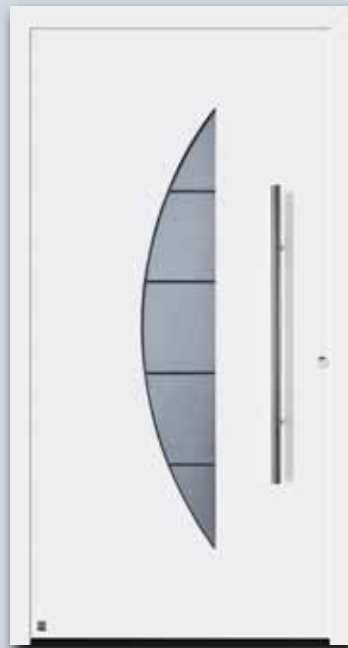

ThermoSafe **style 505**
Traffic white, matt, RAL 9016

Style 505

Stainless steel handle HOE 500,
matt Parsol grey design glass
with 4 clear stripes,
triple thermal insulation glass

Side element MG 505

Design glass infill, matt Parsol grey
with 4 clear stripes,
triple thermal insulation glass

Door version

- **ThermoSafe**

U_D -value of up to 0.9 W/(m²·K)*

* Door size 1230 × 2180 mm

Make your home your castle

Individual design for your home



ThermoSafe **style 503**
In Hörmann colour CH 703 with side elements

Style 503

Stainless steel grip HOE 500, matt float design glass with 7 clear horizontal stripes, triple thermal insulation glass

Side element MG 503

Design glass infill matt float with 7 clear horizontal stripes, triple insulation glass

Door version

- **ThermoSafe**

U_D -value of up to $0.9 \text{ W}/(\text{m}^2 \cdot \text{K})^*$

Style 504

Stainless steel handle HOE 500, matt Parsol grey design glass with 5 clear horizontal stripes, triple thermal insulation glass

MG 504 side element

Design glass infill, matt Parsol grey with 7 clear horizontal stripes, triple thermal insulation glass

Door version

- **ThermoSafe**

U_D -value of up to $0.9 \text{ W}/(\text{m}^2 \cdot \text{K})^*$

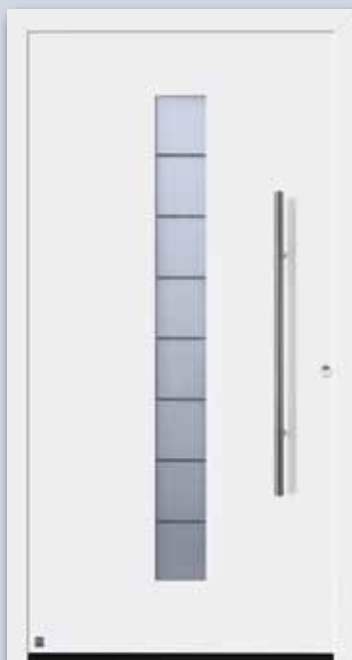

ThermoSafe **style 503**
Traffic white, matt, RAL 9016

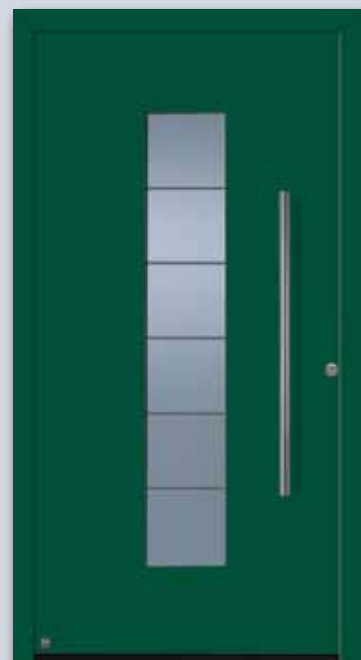

ThermoSafe **style 504**
In Hörmann preferred colour Moss green, matt, RAL 6005



ThermoSafe **style 501**
In preferred colour Window grey,
matt, RAL 7040



ThermoSafe **style 502**
Traffic white, matt, RAL 9016



ThermoSafe **style 177**
Traffic white, matt, RAL 9016



ThermoSafe **style 185**
Traffic white, matt, RAL 9016

Style 501

Stainless steel handle HOE 500,
Mastercarré ornamental glass,
triple thermal insulation glass

Side element

Ornamental glass infill,
triple thermal insulation glass

Door version

- **ThermoSafe**

U_D -value of up to $0.9 \text{ W}/(\text{m}^2\cdot\text{K})^*$

Style 502

Stainless steel handle HOE 500,
Mastercarré ornamental glass,
triple thermal insulation glass

Side element

Ornamental glass infill,
triple thermal insulation glass

Door version

- **ThermoSafe**

U_D -value of up to $0.9 \text{ W}/(\text{m}^2\cdot\text{K})^*$

Style 177

Stainless steel handle HOE 700,
ornamental glass Pave white,
triple thermal insulation glass

Side element

Ornamental glass infill,
triple thermal insulation glass

Door versions

- **ThermoSafe**

U_D -value of up to $0.9 \text{ W}/(\text{m}^2\cdot\text{K})^*$

Style 185

Stainless steel handle 38-2,
ornamental glass Mastercarré,
triple thermal insulation glass

Side element

Ornamental glass infill,
triple thermal insulation glass

Door version

- **ThermoSafe**

U_D -value of up to $0.9 \text{ W}/(\text{m}^2\cdot\text{K})^*$

* Door size $1230 \times 2180 \text{ mm}$

For the comfort of young and old

A Hörmann entrance door is secure and looks good





ThermoSafe **style 110**
In Traffic white, matt, RAL 9016,
with Rondo 70 fascia frame



ThermoSafe **style 140**
In preferred colour Slate grey, matt,
RAL 7015, with Rondo 70 fascia frame

Style 110

Stainless steel handle 38-1,
stainless steel embellishment (style 140),
ornamental glass Pave white,
triple thermal insulation glass

Side element

Ornamental glass infill,
triple thermal insulation glass

Door version

- **ThermoSafe**
U_D-value of up to 0.9 W/(m²·K)*

Style 140

Stainless steel handle 38-1,
stainless steel embellishment (style 140),
ornamental glass Pave white,
triple thermal insulation glass

Side element

Ornamental glass infill,
triple thermal insulation glass

Door version

- **ThermoSafe**
U_D-value of up to 0.9 W/(m²·K)*



ThermoSafe **style 136**
In the preferred colour Window grey, matt,
RAL 7040, with Rondo 70 fascia frame



ThermoSafe **style 166**
In Traffic white, matt, RAL 9016,
with Rondo 70 fascia frame

Style 136

Stainless steel handle 38-1,
stainless steel embellishment (style 166),
design glass Satinato with 7 matt stripes,
triple thermal insulation glass

Side element

Ornamental glass infill,
triple thermal insulation glass

Door version

- **ThermoSafe**
U_D-value of up to 1.1 W/(m²·K)*

Style 166

Stainless steel handle 38-1,
stainless steel embellishment (style 166),
design glass Satinato with 7 matt stripes,
triple thermal insulation glass

Side element

Ornamental glass infill,
triple thermal insulation glass

Door version

- **ThermoSafe**
U_D-value of up to 1.1 W/(m²·K)*

* Door size 1230 × 2180 mm

A bold look

Elegant, exclusive handles



Style 551

Stainless steel handle HOE 150

Side element

Ornamental glass infill,
triple thermal insulation glass

Door version

- **ThermoSafe**

U_D-value of up to 0.8 W/(m²·K)*

ThermoSafe **style 551**
In the preferred colour Anthracite grey, textured, RAL 7016, with side elements



ThermoSafe **style 551**
In Traffic white, matt, RAL 9016,
with Rondo 70 fascia frame



ThermoSafe **style 551**
In Hörmann colour CH 607
with fascia frame Rondo 70

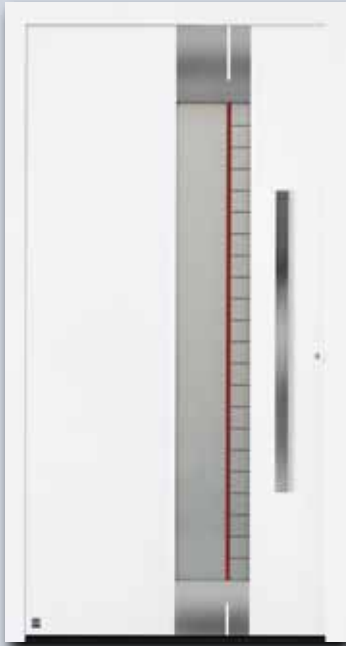

ThermoSafe **style 581**
Traffic white, matt, RAL 9016



ThermoSafe **style 552**
In the preferred colour Anthracite grey, matt, RAL 7016, with Rondo 70 fascia frame



ThermoSafe **style 560**
In Hörmann colour CH 703
with fascia frame Rondo 70



ThermoSafe **style 559**
In Traffic white, matt, RAL 9016,
with Rondo 70 fascia frame

Style 581

Stainless steel handle HOE 600, stainless steel embellishment, matt float design glass with clear stripes and one red stripe

MG 581 side element

Matt float design glass infill with 11 clear stripes

Door version

- **ThermoSafe**

U_D -value of up to $0.9 \text{ W}/(\text{m}^2 \cdot \text{K})^*$

Style 552

Stainless steel handle HOE 150, stainless steel embellishment, matt float design glass with clear stripes and red coloured plastic film

Side element

Ornamental glass infill, triple thermal insulation glass

Door version

- **ThermoSafe**

U_D -value of up to $0.9 \text{ W}/(\text{m}^2 \cdot \text{K})^*$

Style 560

Stainless steel handle HOE 600, stainless steel embellishment, design glass with matt exterior and 11 clear stripes, centre Satinato, interior clear laminated safety glass, triple thermal insulation glass

MG 560 side element

Design glass infill, matt exterior with 13 clear stripes, centre Satinato, interior clear laminated safety glass, triple thermal insulation glass

Door version

- **ThermoSafe**

U_D -value of up to $0.9 \text{ W}/(\text{m}^2 \cdot \text{K})^*$

Style 559

Stainless steel handle HOE 200, stainless steel embellishment, design glass with matt exterior and 11 clear stripes, centre Satinato, interior clear laminated safety glass, triple thermal insulation glass

MG 559 side element

Design glass infill, matt exterior with 7 clear stripes, centre Satinato, interior clear laminated safety glass, triple thermal insulation glass

Door version

- **ThermoSafe**

U_D -value of up to $0.9 \text{ W}/(\text{m}^2 \cdot \text{K})^*$

* Door size 1230 × 2180 mm

Get a handle on it

A beautiful look and comfortable feel



Style 553

Aluminium handle 751 in silver, design glass matt Reflo with genuine fluted glass, triple thermal insulation glass

Side element

Ornamental glass infill, triple thermal insulation glass

Door version

- **ThermoSafe**

U_D -value of up to $0.9 \text{ W}/(\text{m}^2 \cdot \text{K})^*$

ThermoSafe **style 553**
In Hörmann colour CH 607 with side elements and Rondo 70 fascia frame



ThermoSafe **style 553**
In Traffic white, matt, RAL 9016,
with side elements and Rondo 70 fascia frame



ThermoSafe **style 590**
In Traffic white, matt, RAL 9016,
with colour embellishment in the preferred
colour Slate grey, matt, RAL 7015



ThermoSafe **style 583**
In the Hörmann colour CH 703,
with colour embellishment in Black brown,
RAL 8022, with Caro 70 fascia frame



ThermoSafe **style 585**
In Traffic white, matt, RAL 9016,
with aluminium embellishment
in Graphite black, RAL 9011,
with Rondo 70 fascia frame



ThermoSafe **style 585**
In the Hörmann colour CH 703,
with aluminium embellishment
in Graphite black, RAL 9011,
with Rondo 70 fascia frame

Style 590

Design handle G 750 in E6 / EV 1,
aluminium embellishment,
design glass Reflo with sand-blasted
design and genuine fluted glass,
triple thermal insulation glass

Side element

Ornamental glass infill,
triple thermal insulation glass

Door version

- **ThermoSafe**

U_D -value of up to $0.9 \text{ W}/(\text{m}^2\cdot\text{K})^*$

Style 583

Aluminium handle G 755 in E6 / EV 1,
aluminium embellishment,
design glass matt Reflo with clear edge,
triple thermal insulation glass

Side element

Ornamental glass infill,
triple thermal insulation glass

Door version

- **ThermoSafe**

U_D -value of up to $0.9 \text{ W}/(\text{m}^2\cdot\text{K})^*$

Style 585

Stainless steel handle HOE 950,
aluminium embellishment

Side element

Ornamental glass infill,
triple thermal insulation glass

Door versions

- **ThermoSafe**

U_D -value of up to $0.8 \text{ W}/(\text{m}^2\cdot\text{K})^*$

* Door size $1230 \times 2180 \text{ mm}$

For a sophisticated ambience

Elegant door styles with exclusive shapes



ThermoSafe **style 40**
In Traffic white, matt, RAL 9016, with MG 40 side elements

Style 555

Stainless steel handle HOE 910,
stainless steel embellishment, design
glass Reflo with sand-blasted design,
triple thermal insulation glass

MG 555 side element

Design glass infill Reflo with sand-blasted
design, triple thermal insulation glass

Door version

- **ThermoSafe**

U_D -value of up to $0.9 \text{ W}/(\text{m}^2 \cdot \text{K})^*$



ThermoSafe **style 555**
In Hörmann colour CH 703 with side elements MG 555
and Rondo 70 fascia frame



ThermoSafe **style 40**
In Hörmann colour CH 703
with fascia frame Rondo 70



ThermoSafe **style 554**
In Hörmann colour CH 607
with fascia frame Rondo 70



ThermoSafe **style 558**
In Traffic white, matt, RAL 9016, with Rondo 70 fascia frame,
with side elements

Style 40

Stainless steel handle HOE 550,
exterior design glass, laminated safety
glass partially matt in the top section
with stripes, centre clear float
with partially matt stripes offset
from the exterior pane

Side element MG 40

Design glass infill, exterior laminated
safety glass matt in the top section
with stripes

Door version

- **ThermoSafe**

U_D -value of up to $0.9 \text{ W}/(\text{m}^2\cdot\text{K})^*$

Style 554

Stainless steel handle HOE 730,
stainless steel embellishment,
ornamental glass 553,
triple thermal insulation glass

Side element

Ornamental glass infill,
triple thermal insulation glass

Door version

- **ThermoSafe**

U_D -value of up to $0.9 \text{ W}/(\text{m}^2\cdot\text{K})^*$

Style 558

Stainless steel handle HOE 910,
stainless steel embellishment,
exterior design glass, clear laminated
safety glass, centre Reflo
with genuine horizontal fluted glass,
interior matt laminated safety glass

Side element

Ornamental glass infill,
triple thermal insulation glass

Door version

- **ThermoSafe**

U_D -value of up to $1.1 \text{ W}/(\text{m}^2\cdot\text{K})^*$

* Door size $1230 \times 2180 \text{ mm}$

New features for old buildings

Hörmann entrance doors for classic architecture



ThermoSafe **style 449**
Traffic white, matt, RAL 9016

Style 449

Stainless steel handle 38-1,
design glass Reflo with genuine fluted
glass squares

Side element

Ornamental glass infill,
triple thermal insulation glass

Door versions

- **ThermoSafe**

U_D -value of up to $1.0 \text{ W}/(\text{m}^2 \cdot \text{K})^*$



ThermoSafe **style 449**
In the preferred colour Terra brown, matt, RAL 8028,
with side elements



ThermoSafe **style 402**
in Hörmann colour CH 607



ThermoSafe **style 413**
Traffic white, matt, RAL 9016



ThermoSafe **style 675**
In the preferred colour Terra brown, matt,
RAL 8028, with Rondo 70 fascia frame



ThermoSafe **style 694**
Traffic white, matt, RAL 9016

Style 402

Stainless steel handle 14-2,
design glass Reflo, partially matt
with genuine fluted glass

Side element

Ornamental glass infill,
triple thermal insulation glass

Door version

- **ThermoSafe**
U_D-value of up to 0.9 W/(m²·K)*

Style 413

Stainless steel handle 14-2,
ornamental glass Madras silk,
triple thermal insulation glass

Side element

Ornamental glass infill,
triple thermal insulation glass

Door version

- **ThermoSafe**
U_D-value of up to 0.9 W/(m²·K)*

Style 675

Stainless steel handle 38-1,
design glass Reflo, with genuine fluted
glass, triple thermal insulation glass

Side element

Ornamental glass infill,
triple thermal insulation glass

Door version

- **ThermoSafe**
U_D-value of up to 1.0 W/(m²·K)*

Style 694

Stainless steel handle HOE 700,
design glass Reflo, with genuine fluted
glass, triple thermal insulation glass

Side element

Ornamental glass infill,
triple thermal insulation glass

Door version

- **ThermoSafe**
U_D-value of up to 1.0 W/(m²·K)*

* Door size 1230 × 2180 mm

A masterpiece of handles

Stylish, practical, timeless



Style 568

Design handle G 750 in anodised aluminium E6 / EV 1

Side element

Ornamental glass infill,
triple thermal insulation glass

Door versions

- **ThermoSafe**

U_D -value up to $0.8 \text{ W}/(\text{m}^2 \cdot \text{K})^*$

ThermoSafe **style 568**

In the Hörmann colour CH 703 with design handle G 750 in anodise aluminium E6 / EV 1



ThermoSafe **style 568**

In matt Traffic white, RAL 9016,
design handle G 750 in anodised
aluminium E6 / EV 1,
with Caro 70 fascia frame



ThermoSafe **style 568**

In the preferred colour Window
grey, matt, RAL 7040, design
handle G 750 in the Hörmann
colour CH 703, with Caro 70
fascia frame

Persuasive elegance: The design handle G 750 in 3 colours and in RAL to choose



Handle in matt Traffic white, RAL 9016



Handle in anodised aluminium E6 / EV 1



Handle in Hörmann colour CH 703



Handle RAL colour to choose
(shown in matt Ruby red, RAL 3003)

Design handle G 750 is an elegant highlight. A long, continuous handle not only rounds off the exclusive appearance of your entrance door, it is also extremely comfortable to operate. As a result, small children can also open the door using this handle.

* Door size 1230 × 2180 mm

Exclusives design to fit your taste

The DesignPlus handle series



Style 565

DesignPlus handle G 760,
handle bar in the colour of the door,
handle embellishment in anodised
aluminium E6 / EV 1

Side element

Ornamental glass infill,
triple thermal insulation glass

Door versions

- **ThermoSafe**

U_D -value of up to 0.8 W/(m²·K)*

* Door size 1230 x 2180 mm

ThermoSafe **style 565**

In the Hörmann colour CH 703 with DesignPlus handle G 760 in anodised aluminium E6 / EV 1 and handle embellishment in anodised aluminium E6 / EV 1, with side element and transom light



ThermoSafe **style 565**

In the preferred colour Slate grey, matt, RAL 7015, DesignPlus handle G 760 in anodised aluminium E6 / EV 1, handle embellishment in the preferred colour matt Window grey, RAL 7040, with Caro 70 fascia frame



ThermoSafe **style 565**

In the Hörmann colour CH 607, DesignPlus handle G 760 in anodised aluminium E6 / EV 1, handle embellishment in Decograin Golden Oak, with Caro 70 fascia frame

Individual style: the DesignPlus handle G 760



Handle in the Hörmann colour CH 703, handle embellishment in the Hörmann colour CH 703



Handle embellishment in matt Traffic white, RAL 9016, handle in anodised aluminium E6 / EV 1



Handle in anodised aluminium E6 / EV 1, handle embellishment in the Hörmann colour CH 703



Handle embellishment in anodised aluminium E6 / EV 1, handle in anodised aluminium E6 / EV 1



Handle in RAL to choose (shown in matt Ruby red, RAL 3003), handle embellishment in the Hörmann colour CH 703



Handle embellishment in matt Ruby red, RAL 3003, handle in anodised aluminium E6 / EV 1



Handle embellishment in Decograin Golden Oak, handle in anodised aluminium E6 / EV 1

The perfect entrance door needs an exclusive handle. The DesignPlus handle series offers you elegant embellishments to create a customised door. This lets you adjust both the handle and handle embellishment to match the colour of the door and the rest of your home.

Handle embellishments are also available in Decograin timber designs



Decograin Light Oak:
Light, warm oak design



Decograin Golden Oak:
Medium-brown, golden yellow oak design



Decograin Dark Oak:
Walnut-coloured oak design



Decograin Night Oak:
Dark, intense oak design



Decograin Rosewood:
Mahogany-coloured timber design

All-over chic

With straight design milling





ThermoSafe **style 556**
In Traffic white, matt, RAL 9016,
with Rondo 70 fascia frame



ThermoSafe **style 557**
In Traffic white, matt, RAL 9016,
with Rondo 70 fascia frame

Style 556

Stainless steel handle HOE 550

Side element

Ornamental glass infill,
triple thermal insulation glass

Door version

● ThermoSafe

U_D -value of up to $0.8 \text{ W}/(\text{m}^2\cdot\text{K})^*$

Style 557

Stainless steel handle HOE 600

Side element

Ornamental glass infill,
triple thermal insulation glass

Door version

● ThermoSafe

U_D -value of up to $0.8 \text{ W}/(\text{m}^2\cdot\text{K})^*$



* Door size $1230 \times 2180 \text{ mm}$

Powerful overall impression

Entrance door and garage door perfectly matched to each other



ThermoSafe **style 845**

In Traffic white, matt, RAL 9016, with side element MG 845 and sectional garage door LPU 40, M-ribbed, Silkgrain in Traffic white, RAL 9016

Perfectly matched: Entrance door styles and sectional garage doors, M or L-ribbed

The large Hörmann matching programme provides you with aligned entrance door and garage door ribbing options for a matching appearance. The result: No optical offset from the base line. You will see: The beauty of your home is reflected in these small but crucial details.



ThermoSafe entrance doors:

Style 825
Style 845
Style 855

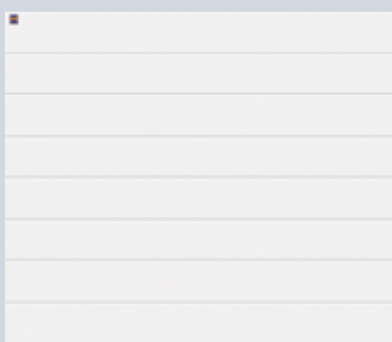

Sectional garage doors, M-ribbed:

with a door height of 2000 mm
with a door height of 2125 mm
with a door height of 2250 mm



ThermoSafe entrance doors:

Style 875
Style 895
Style 898

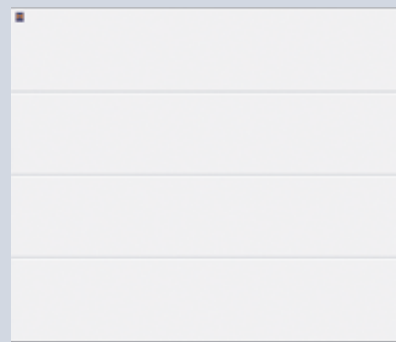

Sectional garage doors, L-ribbed:

with a door height of 2000 mm
with a door height of 2125 mm
with a door height of 2250 mm



After exact on-site measurement, your Hörmann specialist dealer will offer expert advice in choosing the perfect overall look from these entrance door styles.



ThermoSafe **style 693**
Traffic white, matt, RAL 9016



ThermoSafe **style 861**
In Traffic white, matt, RAL 9016, with side elements MG 861 and Rondo 70 fascia frame

Style 693

Stainless steel handle HOE 300

MG 693 side element

Design glass infill, Parsol grey with 3 clear stripes, triple thermal insulation glass

Door version

- **ThermoSafe**
U_D-value of up to 0.8 W/(m²·K)*

Style 861

Stainless steel handle HOE 700

MG 861 side element

Design glass, matt float with 7 clear stripes, triple insulation glass

Door version

- **ThermoSafe**
U_D-value of up to 0.8 W/(m²·K)*

Matched entrance and garage doors

The cross-section of the entrance door and garage doors clearly shows the ribbed look is a result of the grooves in the infill. In the garage door, it comes from the ribbing of the individual sections and the section transitions.



ThermoSafe entrance door cross-section



Sectional garage door cross-section

* Door size 1230 x 2180 mm

The Hörmann Design programme

Garage door and entrance door combined harmoniously
with glass and stainless steel elements



ThermoSafe **style 173**
Without bottom sheet in matt Traffic white, RAL 9016, with side element

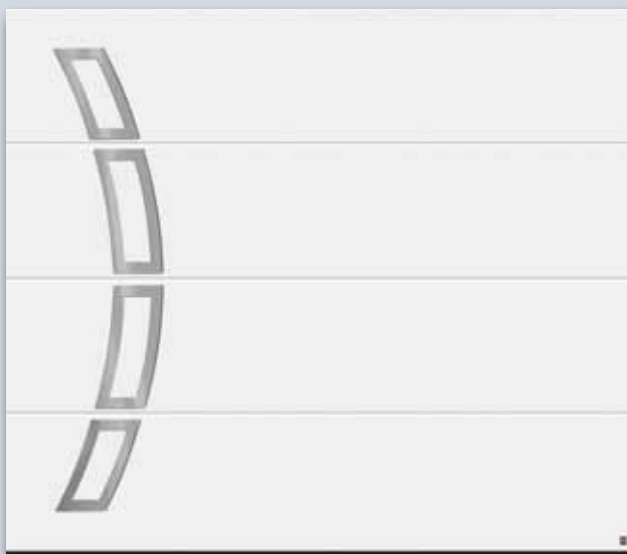

Sectional garage door **style 457** in Traffic white, RAL 9016



ThermoSafe **style 188**
In Traffic white, matt, RAL 9016, with MG 188 side elements



Style 188

Stainless steel handle HOE 100, stainless steel embellishment, matt Stopsol grey design glass with 3 clear stripes, triple thermal insulation glass

MG 188 side element

Design glass infill, matt Stopsol grey with 3 clear stripes, triple thermal insulation glass

Door version

- **ThermoSafe**

U_D-value of up to 0.9 W/(m²·K)*

Style 173

Stainless steel handle HOE 300, stainless steel embellishment, ornamental glass Pave white, triple thermal insulation glass

Side element

Ornamental glass infill, triple thermal insulation glass

Door version

- **ThermoSafe**

U_D-value of up to 0.9 W/(m²·K)*



Sectional garage door **style 453** in Ruby red RAL 3003



ThermoSafe **style 173**
Without bottom sheet in the preferred colour Ruby red, matt, RAL 3003

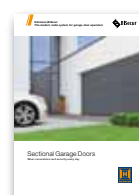

For all the details on the Hörmann design programme, please see the brochure for Hörmann sectional garage doors

* Door size 1230 × 2180 mm

Design within reach

Make your guests feel welcome



ThermoCarbon **style 300**
In Traffic white, matt, RAL 9016, handle bar in White aluminium, RAL 9006, recessed grip in door colour

Style 308

Flush-fitting handle bar in White aluminium, RAL 9006, recessed grip in door colour

Side element

Ornamental glass infill, triple thermal insulation glass

Door version

- **ThermoCarbon**
U_D-value 0.51 W/(m²·K)*



ThermoCarbon **style 308**
In Traffic white, matt, RAL 9016, handle bar and recessed grip in preferred colour Anthracite grey, matt, RAL 7016



ThermoCarbon **style 308**
In preferred colour Slate grey, matt, RAL 7015, handle bar in White aluminium, RAL 9006, recessed grip in door colour



ThermoCarbon **style 300**
In preferred colour Fir green, matt,
RAL 6009, handle bar in White aluminium,
RAL 9006, recessed grip in door colour



ThermoCarbon **style 301**
In Traffic white, matt, RAL 9016,
aluminium embellishment in Graphite
black, RAL 9011, handle bar and
recessed grip in preferred colour Ruby
red, matt, RAL 3003



ThermoCarbon **style 302**
In preferred colour Window grey, matt,
RAL 7040, handle bar in White aluminium,
RAL 9006, recessed grip in door colour



ThermoCarbon **style 312**
In Traffic white, matt, RAL 9016, handle
bar in Traffic white, matt, RAL 9016,
recessed grip in door colour

Style 300

Flush-fitting handle bar in White aluminium,
RAL 9006, recessed grip in door colour

Side element

Ornamental glass infill,
triple thermal insulation glass

Door version

- **ThermoCarbon**
 U_D -value 0.50 W/(m²·K)*

Style 301

Flush-fitting handle bar in White aluminium,
RAL 9006, recessed grip in door colour,
aluminium embellishment

Side element

Ornamental glass infill,
triple thermal insulation glass

Door version

- **ThermoCarbon**
 U_D -value 0.50 W/(m²·K)*

Style 302

Flush-fitting handle bar in White aluminium,
RAL 9006, recessed grip in door colour,
stainless steel embellishments, matt float
design glass with one clear stripe, triple
thermal insulation glass

Side element

Ornamental glass infill,
triple thermal insulation glass

Door version

- **ThermoCarbon**
 U_D -value 0.57 W/(m²·K)*

Style 312

Flush-fitting handle bar in White aluminium,
RAL 9006, recessed grip in door colour,
matt float design glass with one clear
stripe, triple thermal insulation glass

Side element

Ornamental glass infill,
triple thermal insulation glass

Door version

- **ThermoCarbon**
 U_D -value 0.57 W/(m²·K)*

* Door size 1230 × 2180 mm

Welcome home!

Stylish door design



ThermoCarbon **style 306**
In Hörmann colour CH 703, stainless steel handle, recessed grip in door colour, with side element

Style 305

Flush-fitting stainless steel handle, recessed grip in door colour, aluminium embellishment

Side element

Ornamental glass infill, triple thermal insulation glass

Door version

- **ThermoCarbon**
 U_D -value 0.50 W/(m²·K)*

Style 311

Flush-fitting stainless steel handle, high-gloss carbon recessed grip, high-gloss carbon embellishment

Side element

Ornamental glass infill, triple thermal insulation glass

Door version

- **ThermoCarbon**
 U_D -value 0.50 W/(m²·K)*



ThermoCarbon **style 305**
In Hörmann colour CH 703, aluminium embellishment in preferred colour Ruby red, matt, RAL 3003, stainless steel handle, recessed grip in door colour



ThermoCarbon **style 311**
In Traffic white, matt, RAL 9016, carbon embellishment, stainless steel handle, carbon recessed grip



**Style 311 with recessed grip
and embellishment in high-quality carbon**



ThermoCarbon **style 304**
In Hörmann colour CH 703,
stainless steel handle, recessed grip
in preferred colour White aluminium,
silk-gloss, RAL 9006



ThermoCarbon **style 310**
In preferred colour Window grey,
matt, RAL 7040



ThermoCarbon **style 306**
In Hörmann colour CH 607, stainless
steel handle, recessed grip in preferred
colour White aluminium, silk-gloss,
RAL 9006



ThermoCarbon **style 314**
In Traffic white, matt, RAL 9016,
stainless steel handle, recessed grip
in door colour

Style 304

Flush-fitting stainless steel handle,
recessed grip in door colour

Side element

Ornamental glass infill,
triple thermal insulation glass

Door version

- **ThermoCarbon**
U_D-value 0.50 W/(m²·K)*

Style 310

Flush-fitting stainless steel handle,
recessed glazing cut-out,
matt float ornamental glass,
triple thermal insulation glass

Side element

Ornamental glass infill,
triple thermal insulation glass

Door version

- **ThermoCarbon**
U_D-value 0.63 W/(m²·K)*

Style 306

Flush-fitting stainless steel handle,
recessed grip in door colour,
stainless steel embellishment,
matt float ornamental glass,
quadruple thermal insulation glass

Side element

Ornamental glass infill,
triple thermal insulation glass

Door version

- **ThermoCarbon**
U_D-value 0.57 W/(m²·K)*

Style 314

Flush-fitting stainless steel handle,
recessed grip in door colour,
matt float ornamental glass,
quadruple thermal insulation glass

Side element

Ornamental glass infill,
triple thermal insulation glass

Door version

- **ThermoCarbon**
U_D-value 0.57 W/(m²·K)*

* Door size 1230 × 2180 mm

TopComfort aluminium entrance door

Door construction

Full glazing allows for maximum light and is recommended for the entrances to both for single family homes and blocks of flats. A large selection of design glazing also offers numerous options for an individual door design. The TopComfort design comes with numerous advantages:

- [1] Aluminium leaf profile with thermal break
- [2] 80 mm aluminium door frame with thermal break
- [3] Double sealing with an all-round seal
- [4] Triple thermal insulation glass (WSG) with 8-mm safety glass on interior and exterior

Good thermal insulation

**U_D -value
of up to
1.6 W/(m²·K)**

Approved by IFT Rosenheim
Door size 1100 × 2100 mm

Full-scale

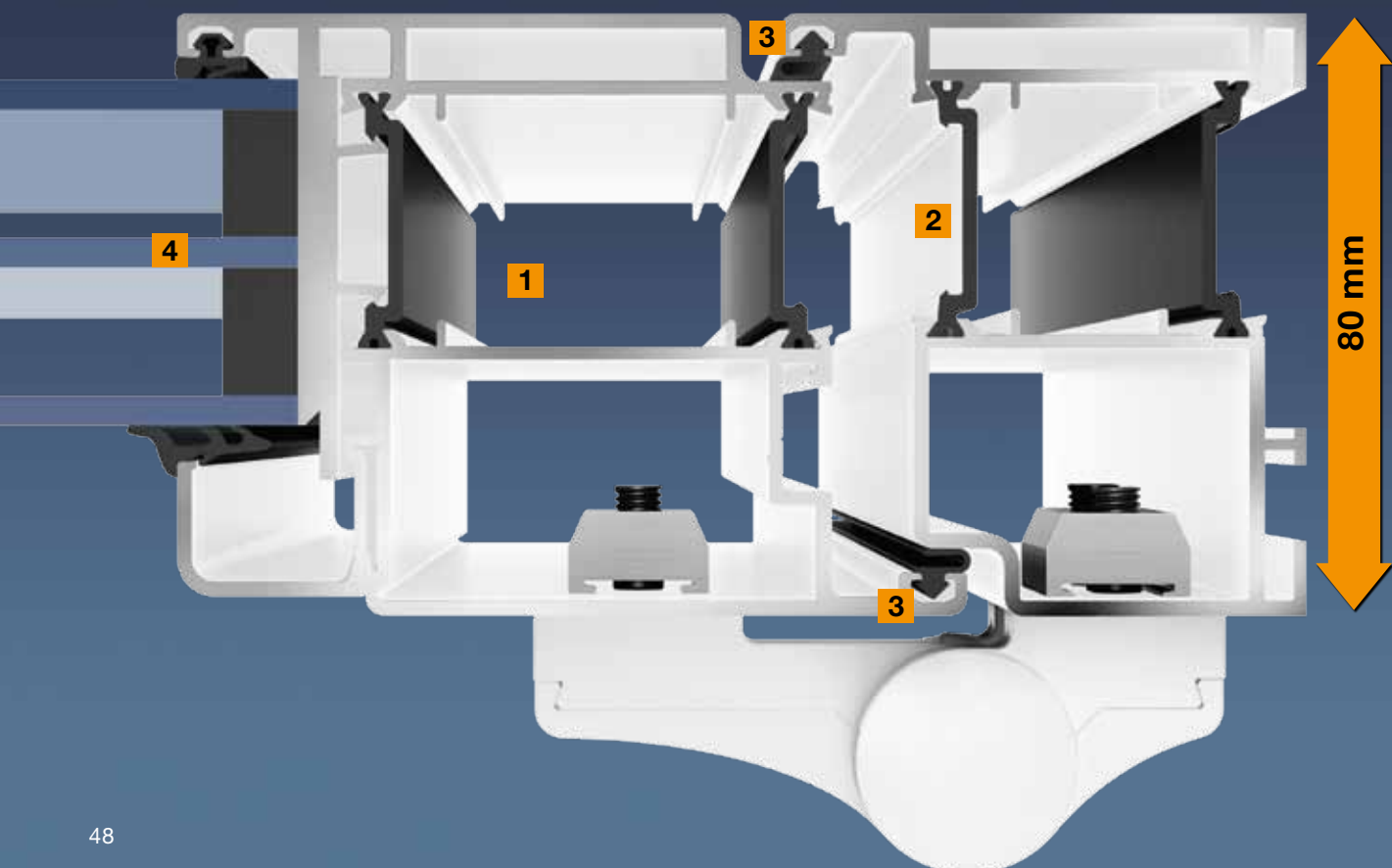



Style 100 in Traffic white, matt, RAL 9016



Style 101 in Traffic white, matt, RAL 9016

Style 100

Knob handle 54, ornamental glass Mastercarré, triple thermal insulation glass

Side element

Ornamental glass infill, triple thermal insulation glass

Door version

- **TopComfort**

U_D-value of up to 1.6 W/(m²·K)*

Style 101

Knob handle 54, ornamental glass Mastercarré, triple thermal insulation glass

Side element

Ornamental glass infill, triple thermal insulation glass

Door version

- **TopComfort**

U_D-value of up to 1.6 W/(m²·K)*

A handy combination of comfort and style

Eight exclusive handle variants are optionally available for TopComfort entrance doors.

Optional at no surcharge



14-1
Stainless steel
with decorative
centre part



14-2
Brushed matt
stainless steel



27-1
White plastic



92-2
Brushed
stainless steel

Optional at a surcharge



38-1
Stainless steel
with decorative
centre part



38-2
Brushed matt
stainless steel



81-1
Polished brass



29-1
Solid brass,
bronzed

* Door size 1230 × 2180 mm

Design glazings

For TopComfort entrance doors style 100 / 101, side elements and transom lights

Design glass MG 111

Centre with 7 matt stripes,
interior Parsol grey,
matt with clear stripes

MG 111 side element

Centre with 7 matt stripes,
interior Parsol grey,
matt with clear stripes

Design glass MG 112

Exterior matt with clear
square, interior Micrograin
(Madras basic)

MG 112 side element

Micrograin (Madras basic)

Design glass MG 113

Exterior with 25 matt stripes,
centre Stopsol grey,
with matt stripes

MG 113 side element

Exterior with 25 matt stripes,
centre Stopsol grey,
with matt stripes



Design glass MG 111

Door profile in preferred colour Anthracite grey,
matt, RAL 7016



Design glass MG 112

Door profile in Hörmann colour CH 607

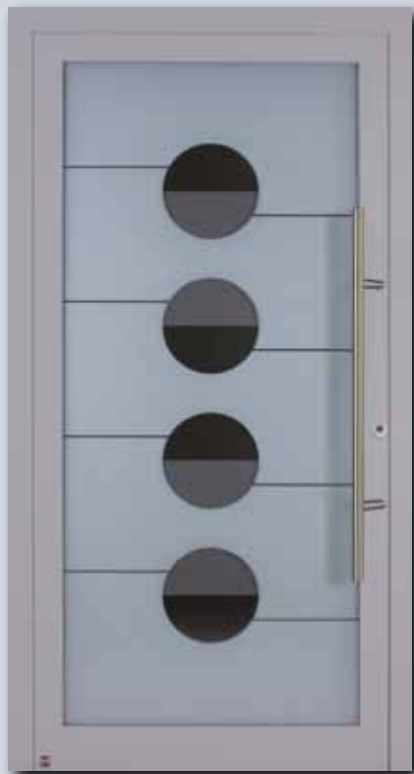

Design glass MG 114

Door profile in preferred colour White aluminium,
silk gloss, RAL 9006



Design glass MG 115

Door profile in preferred colour Slate grey,
matt, RAL 7015



With triple thermal insulation glass



Design glass MG 113
Door profile in matt Traffic white, RAL 9016



Detail of design glass MG 113



Design glass MG 116
Door profile in Hörmann colour CH 703



Design glass MG 117 // NEW
Door profile in matt Traffic white, RAL 9016

Design glass MG 114
Exterior matt with 4 clear circles and 8 clear stripes, interior Stopsol grey with 4 matt semi-circles

MG 114 side element
Exterior matt with 4 clear stripes

Design glass MG 115
Exterior matt with small square, interior matt Ornament 553 with 5 clear squares and 6 slightly matt squares

MG 115 side element
Exterior matt with 5 clear stripes

Design glass MG 116
Exterior with matt squares, interior Reflow with matt crescent and 8 matt stripes

MG 116 side element
Exterior matt with 8 clear stripes

Design glass MG 117 // NEW
Exterior matt with 9 clear stripes, interior matt Parsol grey with 9 clear stripes

MG 116 side element
Exterior matt with 9 clear stripes, interior matt Parsol grey

A friendly reception

More light in your hallway thanks to glazed side elements and transom lights



Design your entrance with side elements and transom lights

To create a prestigious entrance to your home, you can individually combine each of the illustrated ThermoSafe door designs with side elements and transom lights, or combine each ThermoCarbon door design with side elements. An elegant and attractive overall look will please you for a long time to come.



Entrance door with one side element



Entrance door with two side elements



Entrance door with transom light



Entrance door with two side elements and transom light



Style 100 TopComfort with side elements and letter box system

Ideally suited for blocks of flats: side elements with letter box systems

Hörmann can furnish you with the letter box system to suit your taste and the number of flats. Letter box systems and letter drops are available with bell buttons, light switches and intercom mesh, all with high-grade stainless steel covers and with a thermally insulated aluminium panel infill plate for simple mounting without extensive brickworks.



For 1 flat



For 3 flats



For 5 flats

Tailor-made glazings

Your entrance door becomes your signature



Custom glazings for doors, side elements and transom lights

Each glass type has a different look depending on colour, structure and finish. In addition to the glass types suggested in the catalogue images, you may choose any other glass type for your new Hörmann entrance door according to your own personal preference and wishes or match your side elements and transom lights to your entrance door with custom glazings or design glass. You can find an overview of the most popular glass types on the right. Your specialised Hörmann dealer can provide you with prices and delivery times.



Clear float / matt float



Satinato



Stopsol grey / matt Stopsol grey



Pave white



Parsol grey / matt Parsol grey



Mastercarré



Chinchilla



Ornament 504



Ornament 553



Micrograin (Madras basic)



Reflo / matt Reflo



Madras silk, etched

Full range of colours for you

To match your entrance door to your home



Matt, silk-gloss and high-gloss surfaces

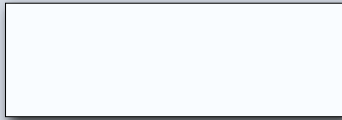

Traffic white, high gloss, RAL 9016

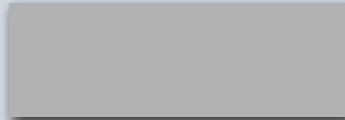

White aluminium, silk-gloss, RAL 9006

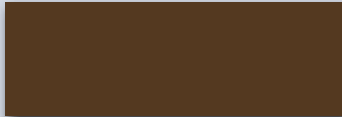

Terra brown, matt, RAL 8028

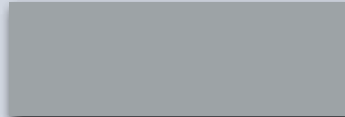

Window grey, matt, RAL 7040

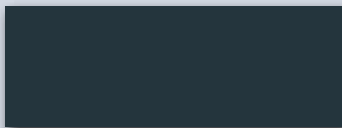

Anthracite grey, matt, RAL 7016

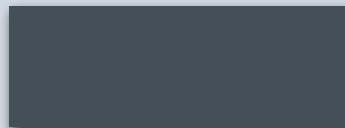

Slate grey, matt, RAL 7015

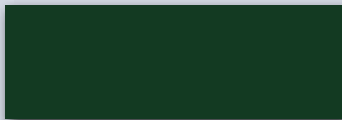

Fir green, matt, RAL 6009

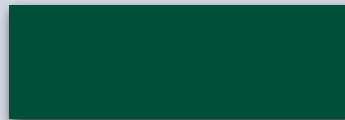

Moss green, matt, RAL 6005



Ruby red, matt, RAL 3003

Textured surfaces // NEW



Anthracite grey, RAL 7016, textured

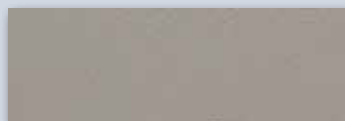

Stone grey, RAL 7030, textured



Quartz grey, RAL 7039, textured



Cream, RAL 9001, textured

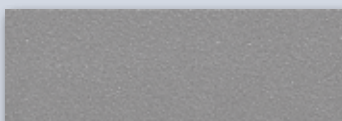

Grey aluminium, RAL 9007, textured

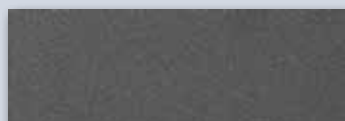

Hörmann colour CH 703 Anthracite, structured

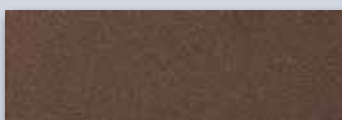

Hörmann colour CH 607, Chestnut, structured

Choose from 16 affordable preferred colours or from many RAL colours



You have many possibilities for the colour design of your new entrance door: You can choose the particularly affordable **matt Traffic white, RAL 9016**, or from **16 preferred colours** (see left) at an attractive price. Of course, you could also choose from all the other **RAL colours**. Many neon and pearl-effect colours are available on request. This means you will find a door at Hörmann that suits your home perfectly.

Design your door colour exactly as you wish, inside and outside

Exterior and interior white

All Hörmann entrance doors in **standard Traffic white, RAL 9016**, are matt powder-coated on the inside and outside.

Exterior coloured, interior white

The Hörmann **entrance doors in 16 preferred colours** (see left) are powder-coated in the preferred colour on the exterior and on the inside in Traffic white, matt, RAL 9016 as standard.

Exterior and interior in a colour of your choice

On request you can have your new entrance doors **colour-coated on both sides**; different combinations are also possible, e.g. Ruby red on the exterior and Slate grey on the interior.

Dark colours should be avoided if the aluminium entrance door is exposed to the sun, as a possible deformation of the leaf may impair door function and leaktightness.

Completely under control

With a design tailor-made to your wishes

Coordinated exterior handles

Each entrance door is already equipped with a handle to match the design. However, on request, you may equip many of our doors with a customised handle. Please consult your specialist dealer for more information on the various options, as well as delivery times and prices.

Elegant interior levers

All **ThermoSafe doors** are equipped with Rondo interior levers in stove-enamelled Traffic white, matt, RAL 9016. These are also optionally available in stainless steel or in a RAL colour of your choice. The stainless steel Caro and Okto lever handles are also available on request.

The **ThermoCarbon doors** are equipped with the stainless steel Caro lever handle as standard.



Rondo aluminium lever handle
in Traffic white, matt, RAL 9016



Caro stainless steel lever handle



Okto stainless steel lever handle

Individual colour combinations

For all exclusive ThermoCarbon entrance door styles, you can individually coordinate the flush-fitting handle bar and recessed grip with the colour of your entrance door or embellishment.

Optional colour combinations for styles 300, 301, 302, 312



Style 300
In Traffic white, matt, RAL 9016, handle bar in Traffic white, matt, RAL 9016, recessed grip in door colour



Style 300
In the preferred colour Slate grey, matt, RAL 7015, handle bar in White aluminium RAL 9006, recessed grip in the preferred colour silk-gloss White aluminium, RAL 9006



Style 301
In Hörmann colour CH 703, aluminium embellishment in preferred colour Ruby red, matt, RAL 3003, handle bar in preferred colour Ruby red, matt, RAL 3003, and recessed grip in door colour

Optional colour combinations for styles 304, 305, 306, 314



Style 304
In Traffic white, matt, RAL 9016, stainless steel handle, recessed grip in preferred colour White aluminium, silk-gloss, RAL 9006



Style 305
In the preferred colour Slate grey, matt, RAL 7015, aluminium embellishment in the preferred colour White aluminium, silk-gloss, RAL 9006, stainless steel handle, recessed grip in the preferred colour White aluminium, silk-gloss, RAL 9006



Style 305
In Hörmann colour CH 703, aluminium embellishment in preferred colour White aluminium, silk-gloss, RAL 9006, stainless steel handle, recessed grip in door colour

Optional colour combinations for style 308



Style 308
In Traffic white, matt, RAL 9016, handle bar in Traffic white, matt, RAL 9016, recessed grip in door colour



Style 308
In preferred colour Slate grey, matt, RAL 7015, handle bar in White aluminium, silk-gloss, RAL 9006, recessed grip in door colour



Style 308
In Hörmann colour CH 703, handle bar and recessed grip in preferred colour Ruby red, matt, RAL 3003

Security you can count on

Hörmann entrance doors offer increased protection for your home as standard

Perfectly protected with standard and optional extras

You can rely on the high quality of Hörmann entrance doors when it comes to security. All doors have multiple-point locking as standard and can also have optional features added. The ThermoSafe and ThermoCarbon entrance doors, side elements and transom lights* are available on request with especially break-in-resistant RC features.



Proven security means you feel at ease

It is good to know that the proven security of Hörmann entrance doors remains, even though the designation is new: instead of "WK" for "Widerstandsklasse" (German for resistance class), the designation is now RC for "resistance class". The testing requirements have also become stricter, now checking to see how much time a potential burglar needs to break in and which tools are used. The carefully tested break-in protection is also recommended by the police information centres.

You can also find more information here:
www.einbruchschutz.polizei-beratung.de (in German)



Invisible security

Increased security doesn't mean that the door can't look good. The optional RC versions include a break-in resistant door version with special security glazings, among other things. The additional security features are not visible in the door. That's brand quality from Hörmann!



Optionally available for all ThermoCarbon, ThermoSafe and TopComfort entrance doors, side elements and transom lights*



Optionally available for all ThermoSafe and ThermoCarbon entrance doors, side elements and transom lights*



Optional for all ThermoCarbon entrance doors
Available from winter 2014

Available from autumn 2014

* Transom lights only available with ThermoSafe version



Securing excellent properties

Automatic lock variants for more security and convenience



Automatic lock S5 Automatic

For ThermoSafe entrance doors with 5-point locking

The latch catch lock with mechanical self-locking is **optionally available at no surcharge** for your ThermoSafe entrance door: if the door falls into the lock, the 4 latch catches automatically extend and reliably lock the entrance door. In addition, the door can also be secured via the lock with another bolt.

Automatic lock S7 Automatic

For ThermoCarbon entrance doors with 7-point locking

All ThermoCarbon entrance doors can be **optionally** equipped with a latch catch lock with 7 bolts, which automatically extend when the door is closed (**free-of-charge**). In addition, the door can also be secured via the lock with another bolt.

S5 / S7 Comfort Connect automatic lock

With the S5 / S7 Comfort Connect lock, the entrance door is automatically locked by the latch catch, just as with the S5 / S7 Automatic. An additional electric motor enables unlocking of the door via external control elements, such as a finger-scan, code switch or hand transmitter (see right). With the innovative **HOE Connect** contact strip, the power and data signals are wirelessly transmitted from door frame to door leaf. The advantage: no more annoying cable! ThermoSafe entrance doors also come with an S5 Comfort lock that transmits the electric and data signals from the door frame to the door leaf via a cable in the door rebate.

The automatic lock S5 / S7 Comfort Connect is prepared for the connection of a button or integration in an existing house intercom, letting you conveniently open your entrance door from the upper floors at the press of a button. This makes it particularly ideal for blocks of flats.



S5 / S7 Comfort – open the door at the push of a button

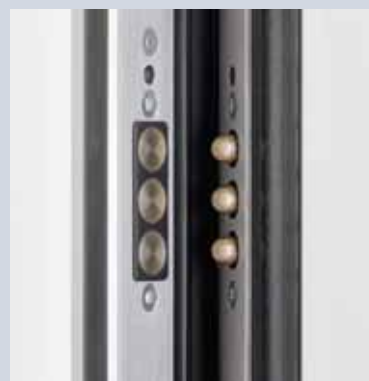

Very practical: HOE Connect

ThermoSafe entrance doors with a 5-point automatic lock S5 ThermoCarbon entrance doors with a 7-point automatic lock S7

Graduated operating convenience

The automatic lock S5/S7 Comfort Connect also comes in further convenient designs, allowing you to open your entrance door with a fingerprint, by entering a code, or via radio. You may, of course, also continue to use a key to open the door.

S5/S7 Scan automatic lock

Open your entrance door with your fingerprint. The finger scanner recognises up to 100 fingerprints and can be taught in without a computer.

S5/S7 Code automatic lock

Simply entering your personal security code opens your entrance door from outside.

S5/S7 Radio automatic lock ↔ BiSecur

Open your entrance door comfortably and securely using the HSE 2 BS hand transmitter. The newly developed and extremely safe BiSecur radio system ensures that no unauthorised person can copy your radio signal. In addition, you can also use the same hand transmitter to operate your Hörmann garage door or entrance gate. The S5/S7 Radio remote control can also be installed in the S5/S7 Scan and S5 Code convenience packages.



With ThermoSafe entrance doors, the **HSE 2 BS hand transmitter** comes as standard in high-gloss black [1] or in a carbon-fibre look [2] for ThermoCarbon entrance doors.



Further information and other BiSecur radio accessories can be found in the Garage door and entrance gate operators brochure.



S5/S7 Scan – open the door with your fingerprint



S5/S7 Code – open the door by entering a code



S5/S7 Radio – open the door using BiSecur radio
(Figure shows combination with S5/S7 Code automatic lock)

TIP:

The S5/S7 automatic locks have been tested and certified by the VDS (German Property Insurance Association). This means that the self-locking doors are considered locked/bolted in case of a break-in, maintaining your claims towards your property insurance.

Well thought out: Hörmann canopies

An attractive look and protection in any kind of weather

Style 105

Stainless steel canopy,
including acrylic glass,
dimensions 1600 × 900 mm
(dimensions 2000 × 1000 mm).

Side fascia in stainless steel,
single-pane safety glass, height
2000 mm, depth 900 mm





Style 405

Aluminium canopy in Traffic white, RAL 9016, including acrylic glass, dimensions 2000 x 1000 mm.



Style 505

Aluminium canopy in Traffic white, RAL 9016, including acrylic glass, dimensions 2000 x 1000 mm.



Style 605

Aluminium canopy in Traffic white, RAL 9016, including acrylic glass, dimensions 2000 x 1000 mm.



Style 605

Aluminium canopy in Hörmann colour CH 703, including acrylic glass, dimensions 2000 x 1000 mm.

Hörmann: Quality without Compromise



Hörmann KG Amshausen, Germany



Hörmann KG Antriebstechnik, Germany



Hörmann KG Brandis, Germany



Hörmann KG Brockhagen, Germany



Hörmann KG Dissen, Germany



Hörmann KG Eckelhausen, Germany



Hörmann KG Freisen, Germany



Hörmann KG Ichtshausen, Germany



Hörmann KG Werne, Germany



Hörmann Genk NV, Belgium



Hörmann Alkmaar B.V., Netherlands



Hörmann Legnica Sp. z o.o., Poland



Hörmann Beijing, China



Hörmann Tianjin, China



Hörmann LLC, Montgomery IL, USA



Hörmann Flexon LLC, Burgettstown PA, USA

Hörmann is the only manufacturer worldwide that offers you a complete range of all major building products from one source. We manufacture in highly-specialised factories using the latest production technologies. The close-meshed network of sales and service companies throughout Europe, and activities in the USA and China, make Hörmann your strong partner for first-class building products, offering “Quality without Compromise”.

GARAGE DOORS
OPERATORS
INDUSTRIAL DOORS
LOADING EQUIPMENT
HINGED DOORS
DOOR FRAMES

