

# SINEAX U 554

## Transducer for AC Voltage with Different Characteristics

With power supply  
RMS value measurement  
Carrying rail housing P13/70



### Application

The transducer **SINEAX U 554** (Fig. 1) converts a sinusoidal or a distorted AC voltage into a **load independent** DC current or a **load independent** DC voltage proportional to the measured value.

Depending on the version, part of the measuring range of interest may be amplified at the beginning or end. The section of no or minor interest is suppressed. A live zero output signal is possible with all versions (see Fig. 3 and 4).

The transducer fulfils all the important requirements and regulations concerning electromagnetic compatibility **EMC** and **Safety** (IEC 1010 resp. EN 61 010). It was developed and is manufactured and tested in strict accordance with the **quality assurance standard** ISO 9001.



Fig. 1. Transducer SINEAX U 554 in housing **P13/70** clipped onto a top-hat rail.

### Features / Benefits

- Measuring input: AC voltage, sine or distorted wave forms, RMS value measurement

Measured variable	Measuring range limits
AC voltage	0 ... 20 à 0 ... 690 V

- Measuring output: Unipolar and live-zero output variables
- Measuring principle: Logarithmic method
- DC, AC-power pack with wide power supply tolerance

### Mode of operation

Input signal  $U_{\sim}$  is galvanically separated from the mains network using a transformer.

The following mathematical expression is then formed using a root-mean-square value computer

$$U_{\text{eff}} = \sqrt{\frac{1}{T} \int_0^T u^2 dt}$$

Following filtration by means of an active filter, the transformation properties of the measuring transducer are determined in the succeeding characteristics circuit.

The output amplifier transforms the measuring signal into an impressed output signal A.

The electronic components are supplied with voltage H from the mains supply unit H.

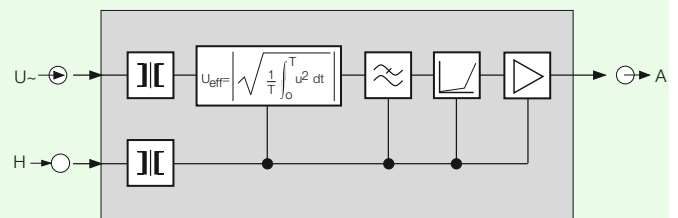

Fig. 2. Block diagram.

### Technical data

#### General

Measured quantity:	AC voltage Sine or distorted wave form RMS value measurement
Measuring principle:	Logarithmic method

# SINEAX U 554

## Transducer for AC Voltage with Different Characteristics

### Measuring input E $\rightarrow$

Nominal frequency  $f_N$ : 50/60 or 400 Hz  
 Nominal input voltage  $U_N$   
 (measuring range end value): 0 ... 20 to 0 ... 690 V  
 Own consumption:  $\leq 1$  VA with input end value  
 Overload capacity:

Measured quantity $U_N$	Number of applications	Duration of one application	Interval between two successive applications
$1.2 \cdot U_N^1$	—	continuously	—
$2 \cdot U_N^1$	10	1 s	10 s

### Measuring output A $\rightarrow$

Load-independent DC current: 0 ... 1 to 0 ... 20 mA  
 resp. live-zero  
 0.2 ... 1 to 4 ... 20 mA

Burden voltage: 15 V

External resistance:  $R_{\text{ext max.}} [\text{k}\Omega] = \frac{15 \text{ V}}{I_{\text{AN}} [\text{mA}]}$   
 $I_{\text{AN}}$  = Output current end value

Load-independent DC voltage: 0 ... 1 to 0 ... 10 V  
 resp. live-zero  
 0.2 ... 1 to 2 ... 10 V

External resistance:  $R_{\text{ext min.}} [\text{k}\Omega] \geq \frac{U_A [\text{V}]}{4 \text{ mA}}$

Current limit under overload:  $\leq 1.5 \cdot I_{\text{AN}}$  at current output  
 Approx. 10 mA at voltage output

Voltage limit under  $R_{\text{ext}} = \infty$ :  $\leq 25$  V

Residual ripple in output current:  $\leq 1\%$  p.p. at setting time 300 ms  
 $\leq 5\%$  p.p. at setting time 50 ms and  $c \leq 2.5$   
 $\leq 5\%$  p.p. +  $c \times 0.5\%$  at setting time 50 ms and  $c > 2.5$

Setting time: 50 ms or 300 ms

### Output characteristics

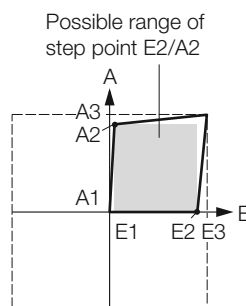

Fig. 3. Characteristic A:  
 $E1 = 0$   
 $0.1 \times E3 \leq E2 \leq 0.9 \times E3$   
 $A1 = 0$   
 $A1 \leq A2 \leq 0.9 \times A3$

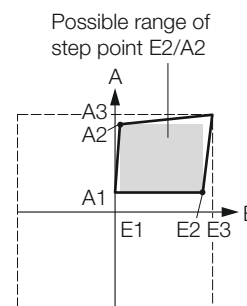

Fig. 4. Characteristic B:  
 $E1 = 0$   
 $0.1 \times E3 \leq E2 \leq 0.9 \times E3$   
 $A1 = 0.2 \times A3$   
 $A1 \leq A2 \leq 0.9 \times A3$

### Power supply H $\rightarrow$

Nominal voltage $U_N$	Rated operating range
AC 230 V	207 ... 253 V

Rated operating range of frequency: 45 ... **50 to 60** ... 65 Hz

Power consumption:  $\leq 3$  VA at  $H = U_N$

DC, AC-power pack (DC or 40 to 400 Hz)

Table 1: Rated voltages and permissible variations

Nominal voltage $U_N$	Permissible variation
85 to 230 V DC, AC	DC – 15 to + 33%
24 to 60 V DC, AC	AC $\pm 15\%$

Option: Connected to the low tension terminal side 12 and 13  
 24 V AC or 24 ... 60 V DC

Power consumption:  $\leq 2$  W resp.  $\leq 4$  VA

### Accuracy (acc. to EN 60 688)

Reference value: Output end value

Basic accuracy: Class 0.5 with setting time 300 ms  
 Class 0.5 x c with setting time 50 ms

Factor c:  $c = \frac{E3}{E2}$   
 with main value magnification in initial range  
 $c = \frac{1}{1 - E2/E3}$   
 with main value magnification in end range

<sup>1</sup>But max. 264 V with power supply from measuring input

# SINEAX U 554

## Transducer for AC Voltage with Different Characteristics

### Reference conditions:

Ambient temperature	15 ... 30 °C
Input variable	Rated operating range
Frequency	$f_N \pm 2$ Hz
Curve shape	Sine-wave
Crest factor	$\sqrt{2}$
Power supply	In rated range
Output burden	Current: $0.5 \cdot R_{ext}$ max. Voltage: $2 \cdot R_{ext}$ min.
Warm-up time	$\leq 5$ min.

### Influence effects (maxima):

Setting time 300 ms	$c = 1$
Setting time 50 ms	$c$ acc. to calculation
Frequency influence	40 ... 400 Hz, $\pm 0.3\% \times c$ 30 ... 1000 Hz, $\pm 0.5\% \times c$
Crest factor	1 ... 2.5 $\pm 0.2\% \times c$ > 2.5 ... 6 $\pm 0.5\% \times c$

Influence quantity	Rated operating range	Permitted effect as factor of precision class
Ambient temperature	- 10 ... <b>15 to 30</b> ... 40 °C	1
	10 ... <b>15 to 30</b> ... 55 °C	3

### Safety

Protection class:	II (protection isolated, EN 61 010)
Housing protection:	IP 40, housing (test wire, EN 60 529) IP 20, terminals (test finger, EN 60 529)
Contamination level:	2
Overvoltage category:	III
Rated insulation voltage (versus earth):	400 V, input 230 V, power supply 40 V, output
Test voltage:	50 Hz, 1 min. acc. to EN 61 010-1 3700 resp. 5550 V, input versus all other circuits as well as outer surface 3700 V, power supply versus output as well as outer surface 490 V, output versus outer surface

### Installation data

Mechanical design:	Housing <b>P13/70</b>
Material of housing:	Lexan 940 (polycarbonate), flammability Class V-0 acc. to UL 94, self-extinguishing, non-dripping, free of halogen

Mounting:	For rail mounting
Mounting position:	Any
Weight:	Approx. 0.3 kg

### Connecting terminals

Connection element :	Screw-type terminals with indirect wire pressure
Permissible cross section of the connection leads:	$\leq 4.0$ mm <sup>2</sup> single wire or $2 \times 2.5$ mm <sup>2</sup> fine wire

### Environmental conditions

Operating temperature:	- 10 to + 55 °C
Storage temperature:	- 40 to + 70 °C
Relative humidity of annual mean:	$\leq 75\%$
Altitude:	2000 m max.
Indoor use statement!	

### Ambient tests

EN 60 068-2-6:	Vibration
Acceleration:	$\pm 2$ g
Frequency range:	10 ... 150 ... 10 Hz, rate of frequency sweep: 1 octave/minute
Number of cycles:	10, in each of the three axes
EN 60 068-2-27:	Shock
Acceleration:	$3 \times 50$ g 3 shocks each in 6 directions
EN 60 068-2-1/-2/-3:	Cold, dry heat, damp heat,
IEC 1000-4-2/-3/-4/-5/-6 EN 55 011:	Electromagnetic compatibility

# SINEAX U 554

## Transducer for AC Voltage with Different Characteristics

**Table 2: Specification and ordering informations**

Designation	*Blocking code	No-go with blocking code	Article No./ Feature
<b>SINEAX U 554</b>	<b>Order Code 554 - xxxx xxxx xx</b>		554 -
<b>Features, Selection</b>			
<b>1. Mechanical design</b> Housing P13/70 for rail mounting			4
<b>2. Nominal input frequency</b> Nominal frequency 50/60 Hz			1
Nominal frequency 400 Hz			3
<b>3. Input voltage, final value</b> Final value E3 ( $\geq 20$ V to $\leq 690$ V*) [V] <input type="text"/>			Z
With power supply from measuring input min. 24 V / max. 230 V, see feature 8. * > 400 V for connection between 2 phases in 3-phase system only			
<b>4. Input voltage, step point</b> Step point E2 (permissible values: $0.1 \cdot E3$ to $0.9 \cdot E3$ ) [V] <input type="text"/>			Z
<b>5. Output signal, initial value</b> Initial value A1: 0 (standard)	A		1
Initial value A1: 20% of final value A3 (live zero)	B		2
<b>6. Output signal, final value</b> Final value A3: 1 mA			1
Final value A3: 5 mA			2
Final value A3: 10 mA			3
Final value A3: 20 mA			4
Non-standard ( $> 1$ to $< 20$ mA) [mA] <input type="text"/>			9
Final value A3: 10 V			A
Non-standard ( $\geq 1$ to $< 10$ V) [V] <input type="text"/>			Z
<b>7. Output signal, step point</b> Without step point ( $A2 = A1$ )			0
Standard step point A2 [mA, V] <input type="text"/> (permissible values: $> 0$ to $0.9 \cdot A3$ )		B	A
Live zero step point A2 [mA, V] <input type="text"/> (permissible values: $> 0.2 \cdot A3$ to $0.9 \cdot A3$ )		A	B
Specify step point A2 in mA or V, acc. to selection of A3 in feature 6.			
<b>8. Power supply</b> AC 230 V (207 ... 253 V)			5
24 ... 60 V DC, AC			A
85 ... 230 V DC, AC			B
Power supply from measuring input ( $\geq 24$ to 60 V AC)			C
Power supply from measuring input ( $\geq 85$ to 230 V AC)			D
Uh: 24 V AC / 24 ... 60 V DC, low terminal side			E
<b>9. Setting time</b> Setting time 0.3 s			1
Setting time 50 ms			2

# SINEAX U 554

## Transducer for AC Voltage with Different Characteristics

Designation	*Blocking code	No-go with blocking code	Article No./ Feature
<b>SINEAX U 554</b>	<b>Order Code 554 - xxxx xxxx xx</b>		554 -
<b>Features, Selection</b>			
<b>10. Test certificate</b>			
Without test certificate			0
Test certificate in German			D
Test certificate in English			E

\*Lines with letter(s) under "no-go" cannot be combined with preceding lines having the same letter under "Blocking code".

### Electrical connections

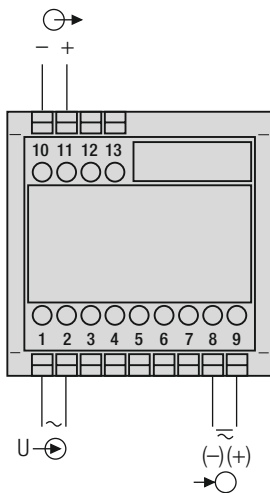

Fig. 5. Power supply connected to terminals 8 and 9.

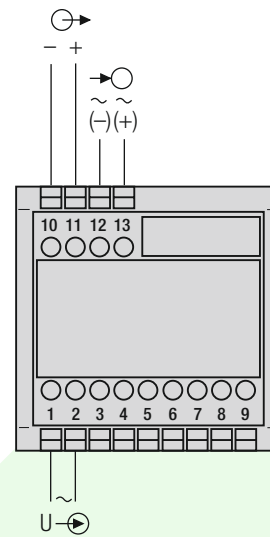

Fig. 7. Power supply connected to the low tension terminal side 12 and 13.

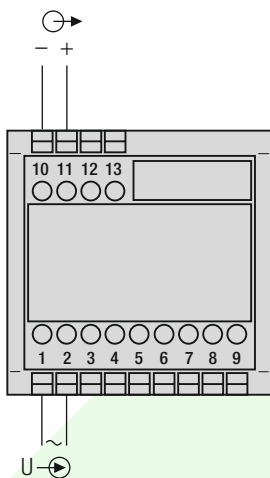

Fig. 6. Power supply internal from voltage measuring input, no power supply connection needed.

- = Measuring input
- = Measuring output
- = Power supply

# SINEAX U 554

## Transducer for AC Voltage with Different Characteristics

### Dimensional drawing

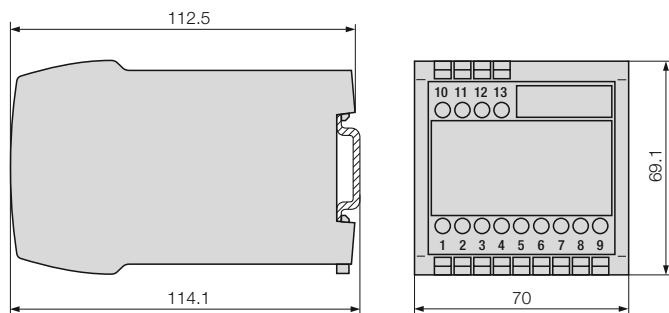

Fig. 8. SINEAX U 554 in housing **P13/70** clipped onto a top-hat rail (35 x 15 mm or 35x7.5 mm, acc. to EN 50 022).

### Standard accessories

1 Operating Instructions in three languages: German, French, English

 **CAMILLE BAUER**

**Rely on us.**

Camille Bauer AG  
Aargauerstrasse 7  
CH-5610 Wohlen / Switzerland

Phone: +41 56 618 21 11

Fax: +41 56 618 21 21

info@camillebauer.com

www.camillebauer.com