

FrontCon

Connection and contacting technology for single-strand insulated power cables

FrontCon

Faster, better connections for single-strand insulated cables.

High-voltage power cables increasingly utilise conductor designs that significantly reduce skin and proximity effects. This enables more power transmission with the same cross-section. The individual strands of these conductors are insulated from each other (enamelled) and are often arranged in segments (Milliken type). This conductor structure complicates the cable connection process. PFISTERER has developed FrontCon, which uses a completely new connector principle to significantly simplify and shorten installation.

New connection technology

Connecting single-strand insulated cable conductors is a time-consuming process that only works to a limited extent: separate the individual strands, strip them one by one, then rearrange them as far as possible in the original form – without damaging any of the strands.

Despite best efforts, the original conductor structure is not achieved at the installation site. Moreover, removing the insulation means losing the benefit of single-strand insulated cables at the end of the conductor. PFISTERER has completely rethought the connection of single-strand insulated conductors.

80% shorter installation time

With FrontCon, PFISTERER has developed a solution that significantly reduces the time required and creates a defined connection via the front face of the cable. Installation takes only around 2 hours – not longer than for conventional cables with standard connections.

At the same time, possible damage when stripping the individual strands is prevented. That significantly reduces the risk of installation errors.

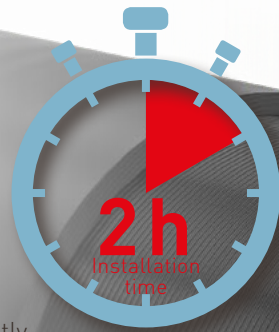

Benefits

- Reliable contact on the front face of the conductors
- Very short installation time
- Insulation does not have to be removed from individual strands
- Compact design
- Safe and simple installation
- Conductor structure is preserved

Compact design

FrontCon is installed directly on the end of the cable – no work is required on the individual strands. Specially developed contact balls make contact with the front faces of the individual strands. Together, these contact balls behave like a liquid. They compensate for slight unevenness at the conductor end, and ensure that the same contact forces are applied across the whole conductor cross-section. Power flows via the conductor front face and the contact balls. This enables a very short and compact contact system for large conductor cross-sections.



Connection with FrontCon: insulation does not have to be removed from individual strands.

FrontCon facts

- Conductor cross-section: up to 2,500 mm² *
- Conductor material: copper *
- All voltage levels

*Larger conductor cross-sections and aluminium conductors on request



Previously, the connection process took around 16 hours.

FrontCon

Faster, better connections for single-strand insulated cables.

High-voltage power cables increasingly utilise conductor designs that significantly reduce skin and proximity effects. This enables more power transmission with the same cross-section. The individual strands of these conductors are insulated from each other (enamelled) and are often arranged in segments (Milliken type). This conductor structure complicates the cable connection process. PFISTERER has developed FrontCon, which uses a completely new connector principle to significantly simplify and shorten installation.

New connection technology

Connecting single-strand insulated cable conductors is a time-consuming process that only works to a limited extent: separate the individual strands, strip them one by one, then rearrange them as far as possible in the original form – without damaging any of the strands.

Despite best efforts, the original conductor structure is not achieved at the installation site. Moreover, removing the insulation means losing the benefit of single-strand insulated cables at the end of the conductor. PFISTERER has completely rethought the connection of single-strand insulated conductors.

80% shorter installation time

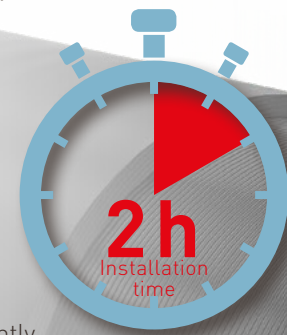

With FrontCon, PFISTERER has developed a solution that significantly reduces the time required and creates a defined connection via the front face of the cable. Installation takes only around 2 hours – not longer than for conventional cables with standard connections.

At the same time, possible damage when stripping the individual strands is prevented. That significantly reduces the risk of installation errors.

Benefits

- Reliable contact on the front face of the conductors
- Very short installation time
- Insulation does not have to be removed from individual strands
- Compact design
- Safe and simple installation
- Conductor structure is preserved

How it works

FrontCon is installed directly on the conductor end. The cable is sawn off straight, and the cable insulation is removed. The pressure-stable contact system clamps centrally onto the conductor. Contact balls are poured into the connector.

Tightening the pressure screw presses the balls against the front face of the conductor ends. Reliable contact is established. A built-in spring mechanism compensates for settling losses. This ensures that contact forces and low transmission resistances are maintained at different temperatures and throughout the full service life.

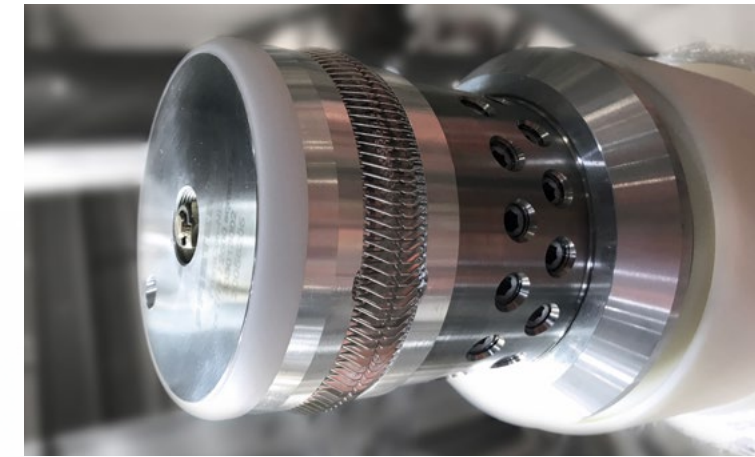

FrontCon: compact contact system for HV cable fittings.

Contact balls behave like a liquid, compensating for slight unevenness and ensuring the same contact force over the whole surface.

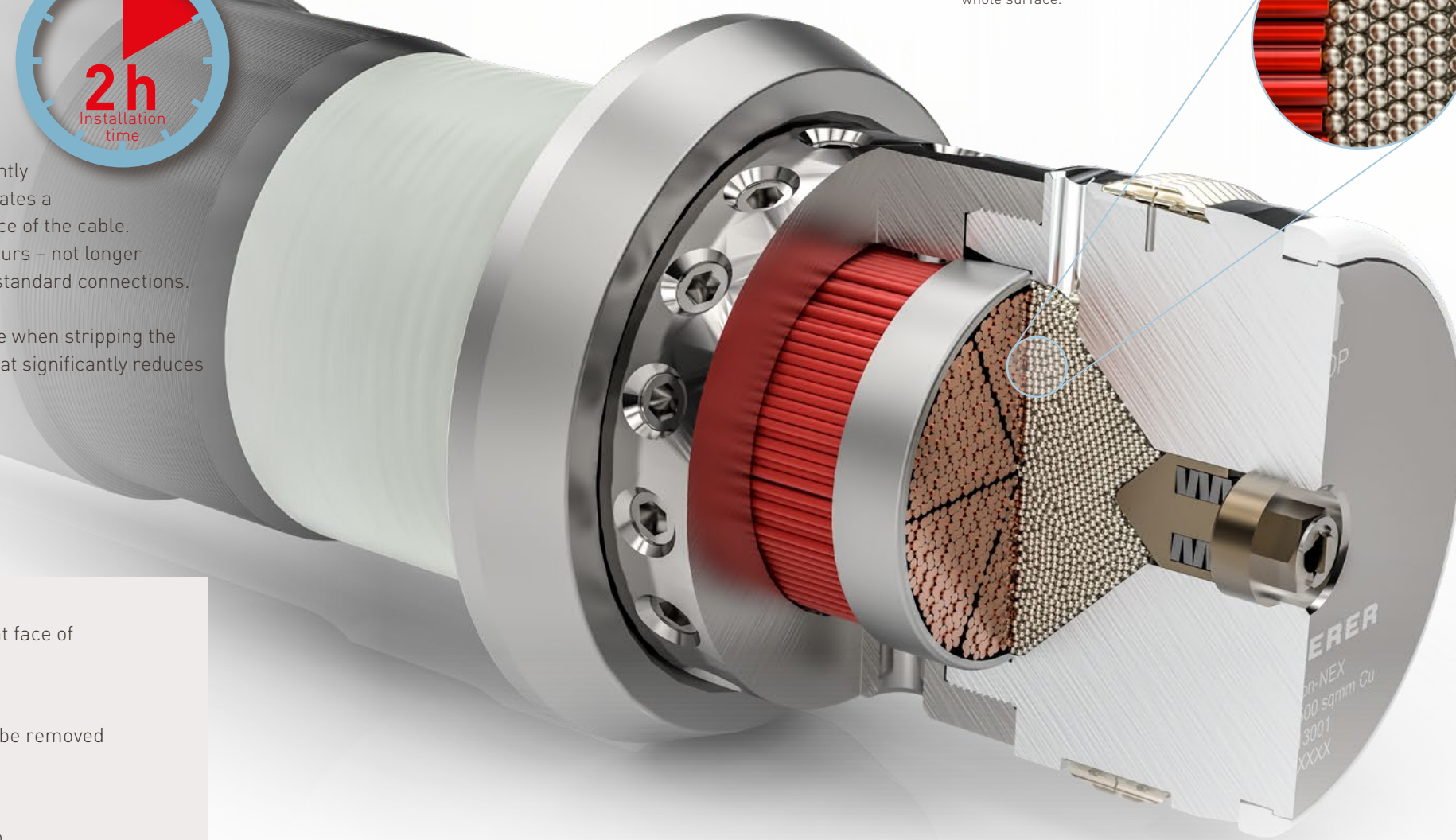
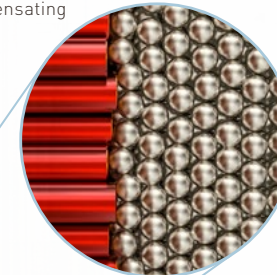

Proven contact system for HV cable fittings

FrontCon is available as a connection technology for CONNEX cable connectors and terminations, as well as for cable connections in MSA joints and type-tested with specific cables. The first cable projects have now been in operation for several years. The contact system can be adapted for any fittings, enabling reliable and cost-effective solutions in cable systems.

It can be installed vertically or horizontally. The range covers copper cables up to a cross-section of 2,500 mm². Other solutions can be implemented on request.



FrontCon ESX:
Outdoor terminations for single-strand insulated HV cables.

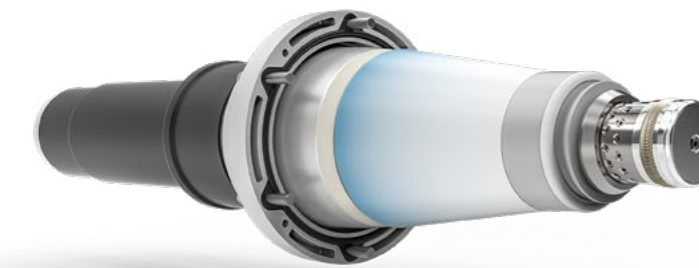

FrontCon NEX:
CONNEX and FrontCon enable the easy and flexible connection of cables with individually insulated strands to power transformers and gas-insulated switchgear.

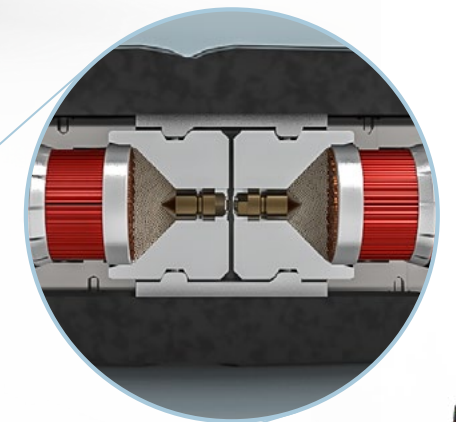

FrontCon MSA:
MSA slip-on joints and FrontCon create compact connections for buried high-voltage cables with single-strand insulated conductors.



Previously, the connection process took around 16 hours.

PFISTERER Holding AG

Rosenstrasse 44
73650 Winterbach
Germany
Phone: +49 7181 7005 0
Fax: +49 7181 7005 565
info@pfisterer.com
www.pfisterer.com

100
YEARS
PFISTERER
SINCE 1921

In 1921, Karl Pfisterer founded his factory in Stuttgart for special electrical products with the aim of improving the world of power transmission. The PFISTERER Group has pursued this goal of quality and technological leadership for more than 100 years. Today, PFISTERER is one of the world's leading specialists and system suppliers for energy infrastructure – with a complete range of cable accessories, overhead line technology and components along the entire transmission chain from power generation to consumption. With state-of-the-art manufacturing processes and 1,200 employees at 18 international locations, PFISTERER not only connects the power grids of today and tomorrow, but also makes an important contribution to a sustainable and secure energy supply.