

# Product catalogue



2012 / 2013

**Measuring. Testing. Automation.**



---

## Intelligent Measurement Technology

■ ■ We at Delphin supply our global customers with intelligent, universal data acquisition hardware and intuitive measurement software. This enables our customers to reliably and efficiently carry out their measurement and monitoring requirements. ■ ■

# Contents

Company	Page 4
Product overview	Page 6
<b>Hardware</b>	
Expert Key	Page 8
LogMessage	Page 12
ProfiMessage / ProfiLab	Page 16
ProfiMessage for vibration measurement technology	Page 22
<b>Software</b>	
ProfiSignal	Page 24
ProfiSignal Go	Page 26
ProfiSignal Basic	Page 28
ProfiSignal Klicks	Page 30
ProfiSignal Module (Interfaces / Runtime / Viewer / Options)	Page 32
ProfiSignal Option (Vibro / AlarmManagement)	Page 34
<b>Complete systems</b>	
Mobile case / 19"-measurement device (64-channel thermocouple measurement device / universal testing device)	Page 36
Industry solutions	Page 38
<b>Services</b>	
Project / Application development / Cabinet construction	Page 40
Calibration / Training / Installation / Service	Page 42
<b>Technical specifications</b>	
Expert Key	Page 44
LogMessage	Page 45
ProfiMessage	Page 46
ProfiSignal	Page 47

# Delphin Technology ... even more solutions

## Delphin Technology AG

Delphin Technology AG was founded in 1980 by the engineer Peter Renner. Since then the company has been involved in the development, production and marketing of innovative, high quality hardware and software for industrial measurement and testing technology.

Areas of application include data acquisition and analysis, quality assurance, test stand automation, vibration measurement, remote monitoring and mobile measurement data acquisition as well as laboratory data acquisition and automation.

Delphin products are being used across many different industries. Our customer base includes companies involved in process engineering, mechanical engineering, the chemical and pharmaceutical industries and power engineering.

## Continuity

Our customers benefit from our technical expertise as well as over 30 years of tried and tested experience we have gained in development within the field of industrial measurement technology. It is important to us to work closely with customers to know their needs and requirements. This is evident from our modular range of products as well as in the long term relationships we establish with our customers.

Many medium sized companies, world renowned industrial corporations, research companies, institutions and universities have put their trust in us and benefit from our many years of experience.



## Quality

Our top priorities are the continuous development of our products and maintaining the highest standards of quality. Delphin Technology AG is certified according to ISO 9001:2008. This guarantees our products meet highest quality assurance requirements and will provide reliable service within your applications. Delphin guarantees products "Made in Germany".

## Innovation

Delphin's mission is to optimize production and processing procedures through continuous technological development. Delphin has at its disposal huge resources of expertise and innovation. Delphin is a specialist in the field of industrial measurement technology and supplies innovative hardware and software from one source. Our many years of experience gives us a solid base in product and application expertise. Our innovations have been patented worldwide.

## Flexibility

Flexibility and simple structures are further elements within our company philosophy.

This means we meet the needs of our customers and provide standard solutions as well as custom-made systems. On request we produce mobile measurement cases, control cabinets and complete test stands or program a specific application software according to your personal requirements using ProfiSignal software.

ProfiSignal Basic

ProfiMessage

LogMessage

Expert Key 200M

Expert Key

ProfiSignal

ProfiSignal Go

Message Series

Expert Key 200P

Expert Key 100C

Expert Key 200L

ProfiSignal Klicks

## Customer services

A range of services complete the Delphin product portfolio. Our services include project planning, system installation, calibration, hotline services and training. System installation and training is carried out by a specialist team of experienced engineers.

Our service packages guarantee customer support from the outset, either by hotline or on-site support when necessary.

# Delphin – Product overview

Technology

## PC-based measurement technology



### Expert Key

- fast
- universal

## Data logger



### LogMessage

- stand alone
- decentralized

## Modular measurement technology & automation



### ProfiMessage

- intelligent
- complete

## Vibration measurement

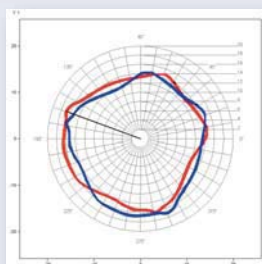

- secure
- innovative





## Data acquisition and analysis

### ProfiSignalGo

- easy to use
- intuitive

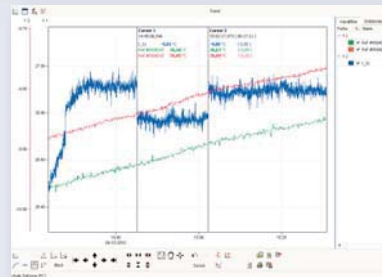

## Operating and monitoring

### ProfiSignal Basic

- universal
- reliable

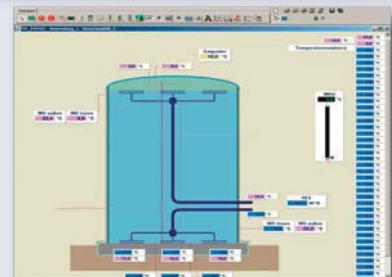

## Automation

### ProfiSignal Klicks

- versatile
- flexible

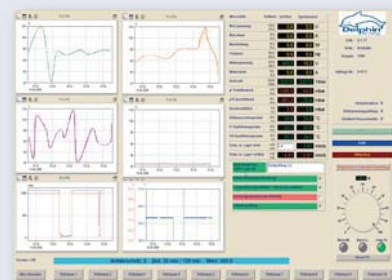

## Compact measurement system

- customizable
- individual



# Expert Key – PC-supported measurement

## Complete measurement data acquisition system

Expert Key devices acquire and monitor measurement data and automate experiment and test stand installations. The devices are supplied as complete systems with ProfiSignal Go – professional software for the online or offline monitoring and analysis of measurement data.

Expert Key is available in four models: for laboratory (L), industry (C), testing (P) and mobile applications (M). Expert Key is therefore a universal and quick to deploy data acquisition system for permanent or mobile systems.

Expert Key is a compact device with a wide range of analog and digital inputs / outputs and plug-in terminals. Expert Key has two alternative interfaces: USB and LAN. These enable measurement data to be acquired locally at a PC or, for example, transmitted from a test stand via a company LAN. Expert Key enables fast system set-up and mobile measurement with a laptop and the ProfiSignal Go software. Expert Key is also suitable for permanent installations using cabinet systems.

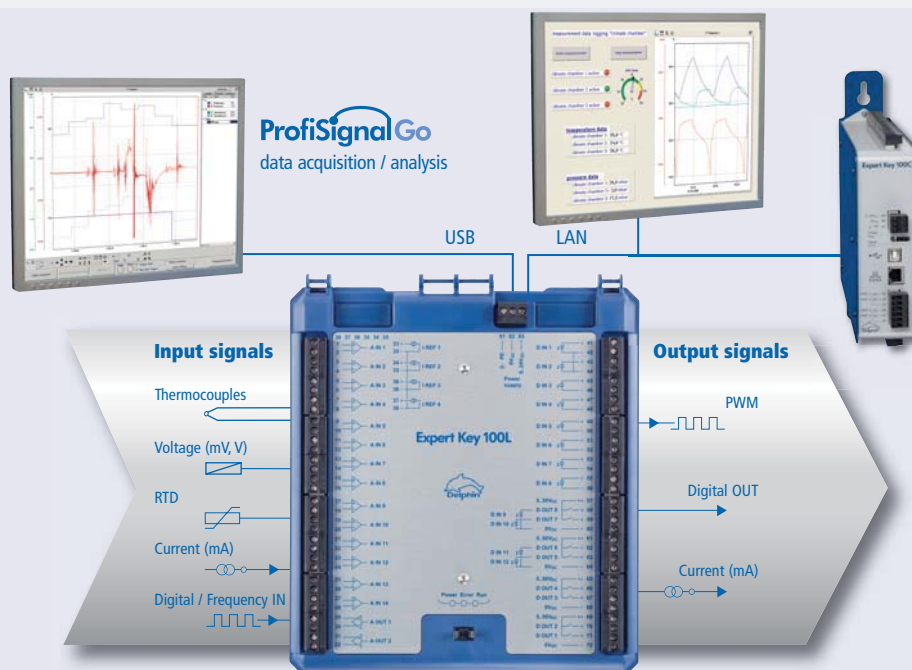

## Product features

- Complete hardware and software package
- Very cost effective
- Communicates via USB or LAN
- Universal inputs and outputs
- Scalable, even for large applications
- Synchronizing of multiple devices
- Includes full ProfiSignal Go software
- Ease of operation
- Drivers for LabVIEW™, Diadem™, Modbus, OPC, DASYLab™ etc.
- "Made in Germany" quality



## Flexible

Expert Key devices are available with a range of channel numbers. Type 100 is equipped with a wide range of analog and digital inputs and outputs and is therefore highly suited for use within test engineering.

Type 200 has 28 universal inputs and is highly suited for analog data acquisition.



**Technical specifications are available on page 44.**

Expert Key		
Type	100	200
Analog inputs (mV, mA, TE, RTD)	14	28
Analog outputs (mA, V)	2	2
Digital inputs	8	1
with counter function	8	1
Digital outputs	4	1
with PWM function	4	1
Switchable digital inputs / outputs	4	–

Expert Key models

## Universal connectivity

Differential inputs are used exclusively as input signals. These can be configured individually as mA, mV or V signals and as RTDs or thermocouples. Any sensor can be attached to the terminals which are able to accommodate lines of up to 2,5 mm<sup>2</sup> in diameter. Integrated signal conditioning enables mA, V measurement data to be converted into the required unit of measurement, e.g., bar, N, %rh etc. In contrast to many low-cost products, Expert Key devices are equipped with full potential isolation.

Analog input sampling rates achieve 100,000 measurement values per second. Analog output signals can be output to V or mA switchable outputs.

Digital inputs (with counter functions of up to 1 MHz) and digital outputs (with PWM function) with switch capacities of up to 30 W are standard in the 100 version.

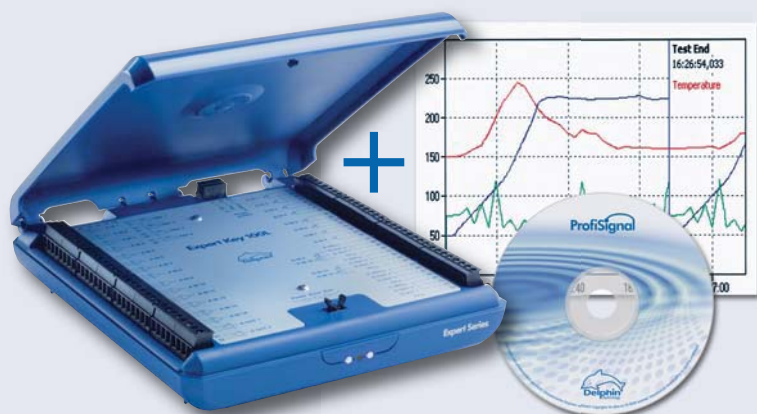

## Complete system including software

Channels are easy to configure using the powerful ProfiSignal Go software included in the Expert Key delivery. ProfiSignal Go has the following drivers to enable integration into the user's existing software systems: LabVIEW™, DASyLab™, OPC-Server, Modbus TCP driver for deployment in industrial environments, as well as the OCX driver and .NET programming interfaces.

# Expert Key – Models

## Expert Key L – for laboratories and service

The Expert Key 100L and 200L have a tabletop design. A pop-up lid gives a clear overview of connections. Sensors and actuators are connected via plugs located on the sides. Because of the L model's universal capabilities, it is particularly suited to laboratory, experiment, test and service applications. Brackets for wall-mounting are included in the delivery as well as a power supply adapter.



**Expert Key 100L**  
**Expert Key 200L**

## Expert Key P – for experiments and testing

The Expert Key 100P and 200P have a console-type design. These models are intended for use in testing and laboratory environments. Signals are connected via 4 mm safety lab plugs. Measurement data from sensors can be transmitted to a PC via USB or LAN interfaces. RTD sensors, voltage and current signals are directly connected to any of the analog inputs. ProfiSignal software enables users to generate systems for data acquisition that comply to FDA 21 CFR Part 11.

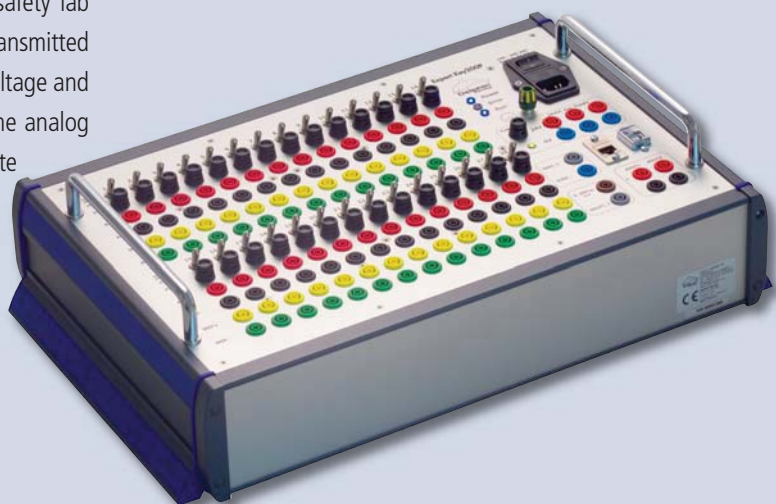

**Expert Key 100P**  
**Expert Key 200P**

## Expert Key C – for cabinet installation

The Expert Key 100C and 200C are identical to the L models apart from the housings. The housing design enables the devices to be used in cabinets or 19" rack systems.

Expert Key can also be supplied without an housing to enable OEM systems.



**Expert Key 100C**  
**Expert Key 200C**

## Expert Key M – Mobile measurement

The Expert Key 100M and 200M are mobile data acquisition systems comprising an Expert Key L device and a tablet PC. The package includes the ProfiSignal Go software.

Mobile cases can be supplied as standard or custom made systems for individual requirements. PCs are available in tablet or notebook formats.



**Expert Key 100M**  
**Expert Key 200M**

# LogMessage – Data logger

## Stand alone and intelligent

LogMessage is a stand alone operating device for acquiring, monitoring, calculating and logging measurement data. It is equipped with a memory for logging up to 128 million measurement values.

The LogMessage's analog inputs are differentially and galvanically isolated from each other as well as from the power supply. Earth loops and non-isolated sensors therefore present no problem. All analog inputs can be used universally and are capable of measuring any type of thermocouple, RTD, voltage or current signal.

Channel configuration takes place via the easy to use DataService Configurator software included with the delivery. The devices are supplied as complete systems with the ProfiSignal Go software – professional software for online or offline monitoring and analysis of measurement data.

Configuration and measurement data read-out takes place via a network interface. LogMessage's two serial ports enable modem connection for either remote access or connecting to external hardware for data transfer purposes. Alarm notifications and text messages may be transmitted using a GSM modem. When the LogMessage device is operated within a network, measurement data can be transmitted online and processed using the ProfiSignal Go software.

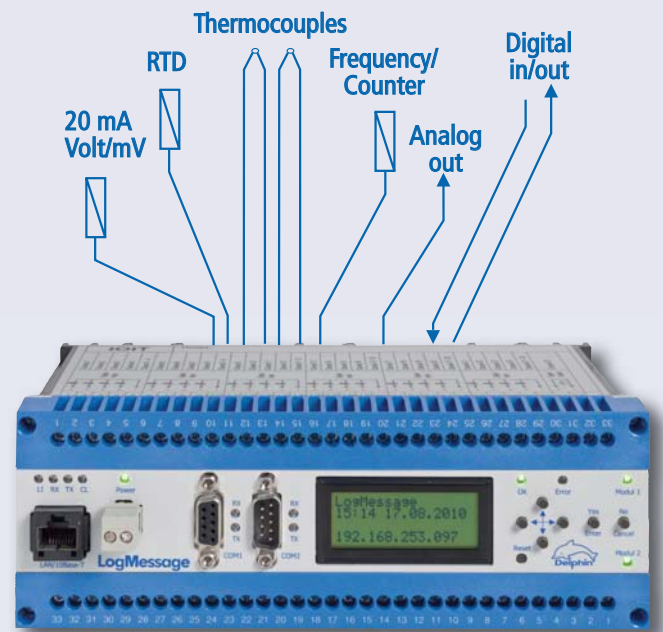

## Product features

















- ProfiSignal Go software included in package
- Differential and galvanic isolation of inputs
- LAN interface for data transfer
- 1 GB internal memory for 128 million data records
- Monitoring and alarm functions
- Integrated signal conditioning
- Web Server interface
- 2 configurable serial ports
- A range of internal calculation and logic channels
- Protocols: Modbus RTU and TCP

## Full signal pre-processing

LogMessage is equipped with a range of internal calculation, monitoring and logic functions that are set up as software channels.

These software channels process online measurement data and make it available for visualization, storage or control purposes. Whole program sequences can be configured into the device, simply and intuitively using control functions. These then run independently and require no PC support.

The functions listed in the table opposite are available as standard.

Icon	Function	Description
	Average	Min, max, moving, time-based ...
	Calculation channel	Trigonometry, +* /, root, power ...
	Markers	Variable
	Integrator	Integrator, edge counter, stop clock ...
	Differentiator	Slope calculations
	Set point	Set point curves
	PID controller	P, PI, and PID controller
	Linearization	Linearization tables
	Strain gauge rosette	Calculation from $\epsilon_x$ and $\phi$
	Limit value	Monitoring, wire breaks, watchdog ...
	Logic	NOT, AND, OR, NOR, EXOR ...
	FlipFlop	Type D, J-K, S-R
	Timer	Alarm, signal generator, PWM ...
	Event	Email, text message via GSM/UMTS router
	X-Message	Direct connection between 2 devices
	Modbus (LAN)	Modbus TCP connection

## Complete system including software

LogMessage devices are supplied with the powerful ProfiSignal Go software. ProfiSignal Go is professional PC software for the online and offline monitoring and analysis of measurement data.

To enable integration into existing software systems, the following drivers are included with Log Message in addition to the ProfiSignal Go software:

- LabVIEW™, DASyLab™, OPC Server
- Modbus TCP drivers for deployment in industrial environments
- OCX driver, .NET programming interface

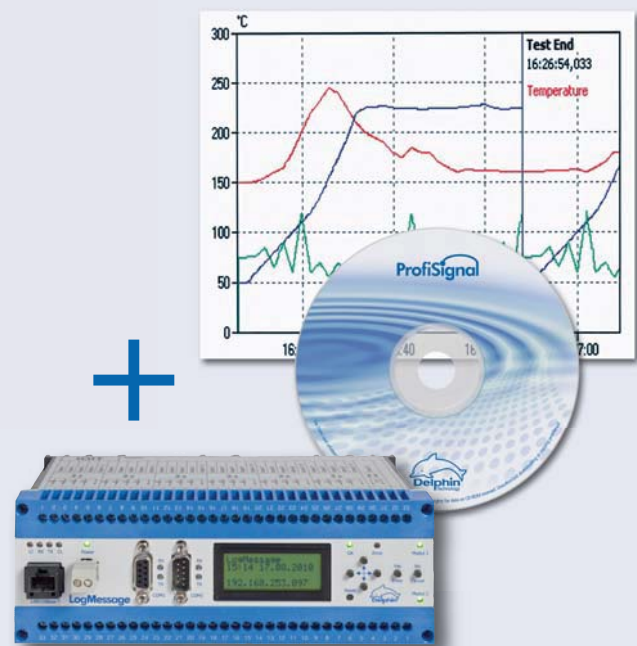

# LogMessage – Models

## Models

LogMessage devices are available in seven different models. The models differ in their number of inputs and outputs. All models have identical interface options, internal functions, galvanic isolation and data logger storage functions.

### LogMessage 100 – The entry model with 15 analog inputs

The LogMessage 100 is equipped with 15 analog inputs and a sampling rate of up to 600 measurements per second. The inputs can be used for data acquisition from mV, mA signals or any type of thermocouple. All inputs have differential and galvanic isolation.

### LogMessage 200 – Data acquisition and automation

The LogMessage 200 is equipped with 10 universal analog inputs, one analog output, 12 digital inputs (11 counters) and 17 digital outputs. The device has a range of internal monitoring and control functions that enable it to be used as a data acquisition device as well as an independently operating system for control, automation or monitoring.

### LogMessage 300 – Fault diagnostics made easy

The LogMessage 300 is equipped with 15 analog inputs (600 Hz sampling rate) and 24 synchronous digital inputs (with a time resolution of 1 msec). The device is highly suited to fault analysis as well as to digital and analog events.

### LogMessage 400 – The monitoring device

The LogMessage 400 is ideal for monitoring requirements. Any number of alarm and logic channels can be defined for the 15 analog inputs. Any of the 24 digital outputs are directly switchable irrespective of the current alarm situation.

### LogMessage 500 – galvanic isolation voltage to 650V DC

The LogMessage 500 is equipped with 16 universal analog inputs. The inputs are designed to cope with high voltages between the individual inputs. The LogMessage 500 therefore has no problem in measuring non-isolated signals.

### LogMessage 600 – The universal logger

The LogMessage 600 is equipped with 25 analog inputs. The device can be used for direct data acquisition, monitoring and recording from any thermocouple or RTD sensor.

### LogMessage 700 – The thermocouple logger

The LogMessage 700 can acquire measurements from up to 30 thermocouples. Configuration software is used to set channels to specific thermocouple types.

### LogMessage 800 – Independent measurement and control

The LogMessage 800 is equipped with 15 analog inputs and 12 synchronous digital inputs. It also has 16 digital outputs for alarm and control purposes.



**Technical specifications are available  
on page 45.**

## LogMessage

Type	LM100	LM200	LM300	LM400	LM500	LM600	LM700	LM800
Analog inputs (mV, mA, thermocouple)	15		15	15		15	30	15
Analog inputs (mV, mA, thermocouple, RTD)		10			16	10		
Analog outputs (mA)		1				1		
Digital inputs (counter)		12 (11)	24	1				12 (11)
Digital outputs		17	1	24		1		16
Sampling rate in Hz	600	600	600	600	120	1200	1200	600

LogMessage versions

## Various Applications

- Stand alone, universal data logging
- Temperature measurement
- Remote data transfer via GSM / UMTS
- Process data acquisition
- Fault analysis with recorder functions
- Laboratory data acquisition and management
- GPS logging
- Status and event logging
- Energy consumption acquisition and measurement



**An integrator channel accumulates energy figures, volume flows or consumption figures. By using a limit value channel, permanent monitoring can be performed with an event being triggered when the**

**limit is over-run or under-run. A digital output can then be activated or an alarm sent by email.**

# ProfiMessage – Modular data acquisition

## Modular and secure

ProfiMessage is the new modular system for data acquisition, monitoring and automation of machinery, plant and test stands. ProfiMessage uses master and slave devices and a range of I/O modules to enable it to be adapted to any application.

ProfiMessage is for applications requiring high-speed, precision data acquisition with galvanic isolation, intelligent data preprocessing and monitoring functions. Areas of application range from the monitoring of industrial processes, plant and clean rooms through to data acquisition and test stand automation.

ProfiMessage devices have universal connectivity. The devices are equipped with flexible I/O modules and a range of field bus interfaces. Connecting to PLC control systems for data exchange is easy and problem-free. Measurement data is stored with extremely high time resolution making it particularly suited to systems for fault data acquisition and diagnostics.

The compact devices measure and store data as stand-alone, independent systems. An internal 16 GB memory is able to record.

The data can also be accessed online via an Ethernet interface, either manually or automatically according to predefined time plans. At the press of a button on the USB port, the data can be transmitted to a USB memory stick and evaluated offline.

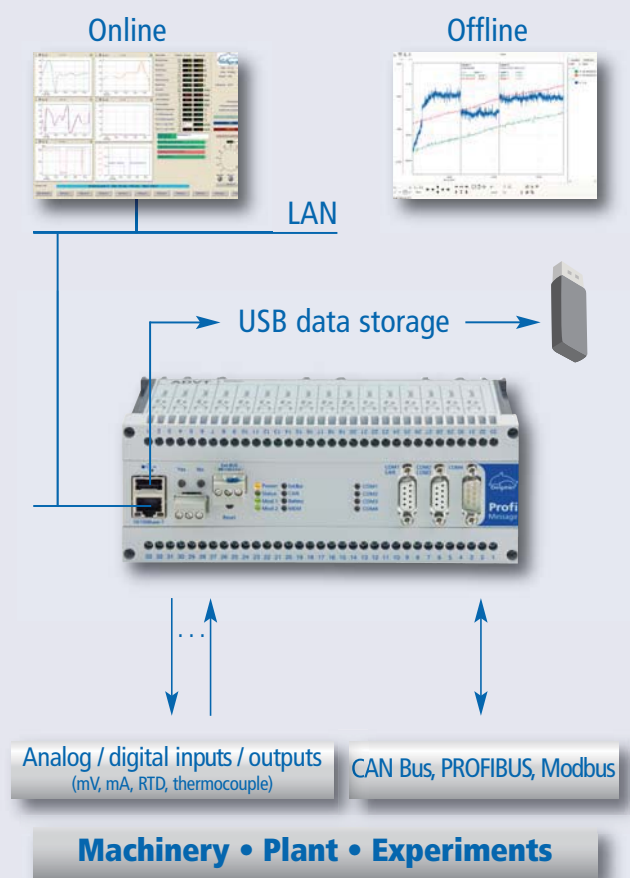

## Applications

- Modular data acquisition and monitoring
- Process data acquisition and data preprocessing
- Fault data acquisition and damage diagnostics
- Acquisition, processing and recording of PLC and field bus signals
- Monitoring device for process and vibration signals
- Automation device for experiments and test stands
- Intelligent data logger with high capacity memory
- Remote monitoring device for plant and machinery
- Laboratory data acquisition and automation



# and automation

## Intelligent monitoring and analysis

In conjunction with vibration measurement I/O modules, the ProfiMessage becomes a shaft and bearing vibration measurement device. Devices are then typically deployed in monitoring and analysis systems for condition monitoring. By attaching modems or router, users can use ProfiMessages as independent remote monitoring systems for plant, marine vessels, vehicles or similar decentralized machinery.

ProfiMessage devices are equipped with further functions in the form of software channels. Software channels enable functions such as threshold value monitoring, mathematical integration or online computations. They are extremely easy to configure. Users are then able to program their own monitoring or online analysis systems into the device without requiring any IT expertise. Delphin products stand out with this functionality. Users are then able to quickly and effectively deploy their ProfiMessage devices for their day to day requirements.

## Functions

- Acquisition, recording, analysis of measurement data
- Monitoring and automation functions
- Combined process and vibration data
- Universal analog inputs with high precision capability
- Galvanic isolation across channels
- Simple, intuitive configuration and operation
- Ethernet interface for online operation
- USB interface for data memory read out
- Two PROFIBUS interfaces (single or redundant, according to PNO 2.212 V1.2)
- Four serial interfaces
- Freely configurable CAN bus interface
- Compact, modular design
- XML format configuration



### ProfiMessage and ProfiLab with identical functions.

#### ProfiLab – for the laboratory

- Laboratory-proof, robust tabletop design
- 4 mm laboratory or BNC connectors



#### ProfiMessage – for industry

- Industrial-grade, compact design for cabinet installations
- Screw terminals



# ProfiMessage – Functions

## Universal and galvanically isolated

Depending on the type of I/O module being used, each input can be configured separately to measure mV, mA, RTDs and thermocouples. Universal inputs enable the measurement of voltages, currents or temperatures making ProfiMessage extremely flexible to deploy. ProfiMessage is also equipped with digital inputs, for functioning as status or frequency inputs, as well as digital / analog outputs.

A major benefit of the ProfiMessage device is the differential, high-precision and galvanic isolation of its inputs and outputs – isolation from channel to channel and from the power supply.

Earth loops and non-isolated sensors therefore present no problems. This unique system architecture enables problem free non-isolated measurement.

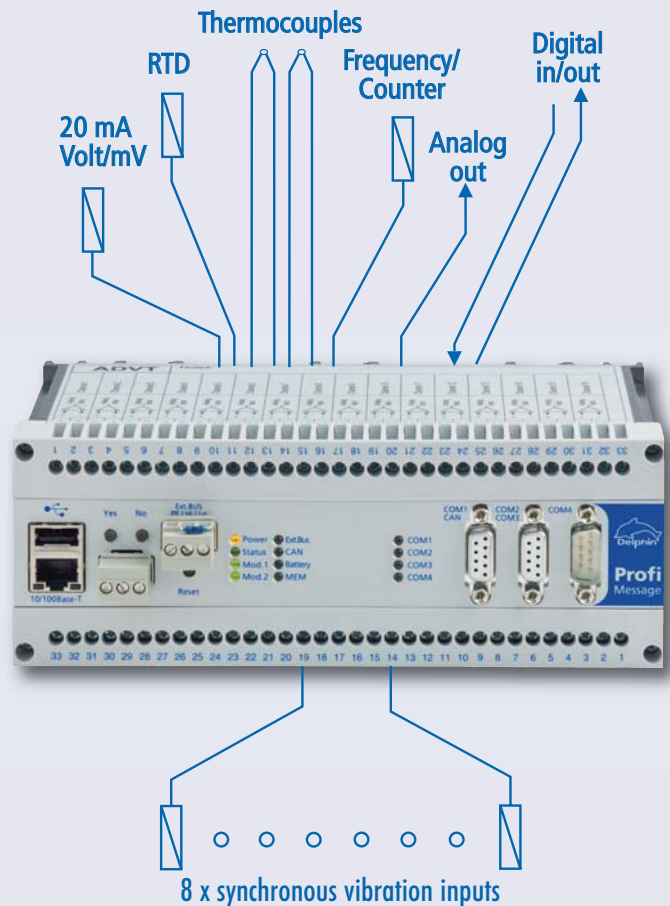

## Simple and intuitive configuration

Configuration of ProfiMessage devices takes place using Configurator software that is included in delivery. The software gives a clear overview of channels, with operation being intuitive and similar to the Windows Explorer functioning. Double-clicking a channel opens a configuration dialog portraying all the channel's properties.

The individual configuration files are stored in XML format within the ProfiMessage devices and can therefore be accessed and updated offline using an XML editor.

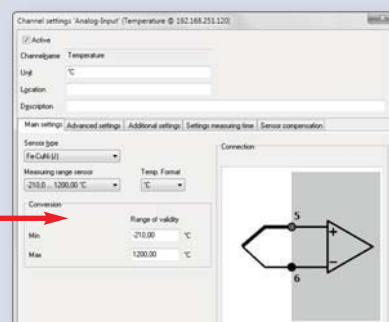
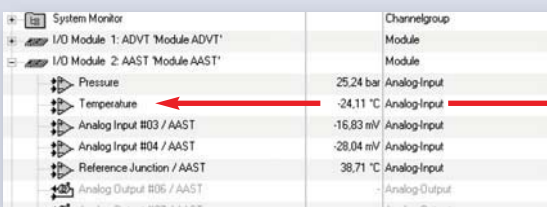

# I/O modules

## Flexible and extendible

ProfiMessage master/slave devices can be equipped with two modules (see table below). Up to 20 slaves, with identical housings, can be connected to a master device. Data exchange between devices takes place via a real-time expansion bus using robust two-wire technology. Slave devices can be decentrally installed and administered from a master device. Nine different I/O modules are available

for ProfiMessage. A master or slave may contain either two identical or two different I/O modules. Master devices are also available without internal I/O modules for the exclusive processing of field bus signals – such devices can then function as PLC data loggers or deployed for process fault detection and diagnostic systems.

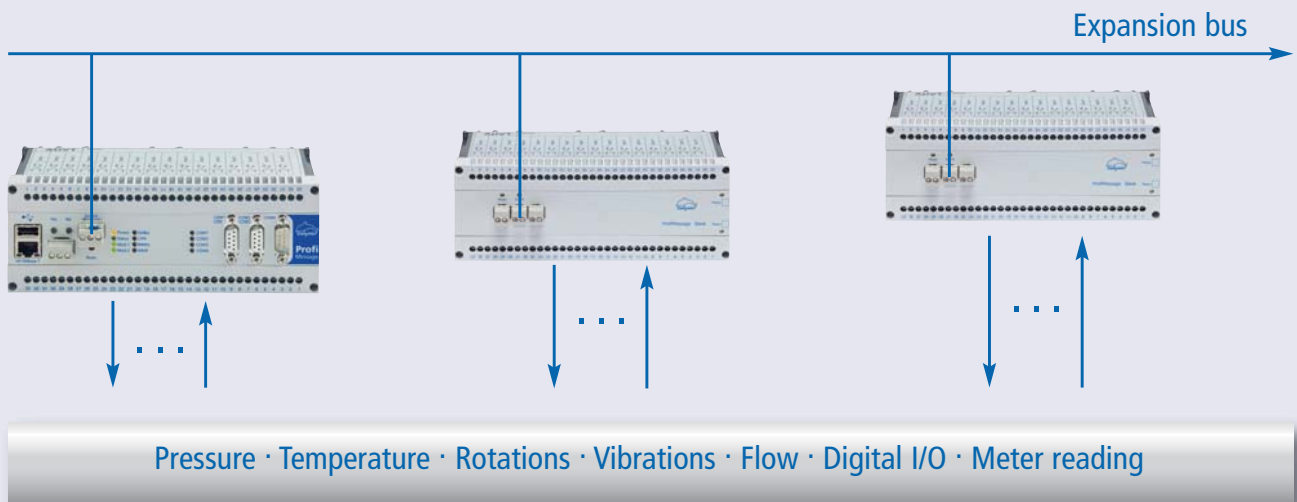

I/O-Modules	Analog inputs	Analog outputs	Frequency Status inputs	Status inputs	Switch outputs	Sum Samplingrate
<b>ADGT</b>	8 channels, V/mV, 20 mA, RTD, thermocouples					60 Hz
<b>ADIT</b>	10 channels, V/mV, 20 mA, RTD, thermocouples	1 channel 20 mA			1 channel	600 Hz
<b>ADV T</b>	15 channels, V/mV, 20 mA, thermocouples					600 Hz
<b>ADFT</b>	8 channels V/mV, 20 mA	2 channels 0 ... 10 V DC	2 channels	2 channels	4 channels	10 kHz
<b>AMD T</b>	8 channels V/mV, 20 mA	2 channels 0 ... 10 V DC	2 channels	2 channels	4 channels	10 ... 160 kHz
<b>AAST</b>	4 channels, V/mV, 20 mA, RTD, thermocouples	4 channels 20 mA		2 channels	2 channels	600 Hz
<b>IOIT</b>				24 channels	1 channel	
<b>OTPT</b>				1 channel	24 channels	
<b>DIOT</b>			11 channels	1 channel	16 channels	

# ProfiMessage – Interfaces

## A range of interfaces

ProfiMessage offers a range of field bus interfaces. A master device has two PROFIBUS DP slave interfaces (redundant according to PNO 2.212 V1.2), one Modbus TCP, one Modbus RTU, and one freely configurable CAN interface. The interfaces can also be used to connect any serial measurement devices and sensors via RS232/485. An Ethernet high-speed connection is available for connecting ProfiMessage to a PC workstation or server.

## PROFIBUS

ProfiMessage is equipped with two separate PROFIBUS DP slave interfaces. ProfiMessage integrates into PROFIBUS using GSD files. Virtually any analog or digital signal can be read or written from PROFIBUS. An option is available to switch the type of operation to redundant PNO 2.212 V1.2 PROFIBUS.

## Modbus TCP / RTU

The LAN and RS485 interfaces can also transmit data via the Modbus TCP / RTU protocol. ProfiMessage supports both Modbus master or slave operation.

## RS232 / RS485

The serial interfaces are able to function under different protocols. The protocols can be generated either by the user or by Delphin. ProfiMessage serial interfaces are being used in climate chamber operation, for laboratory equipment, for power measuring hardware and GPS receivers.

## CAN bus

The CAN bus interface can be programmed as required. Any identifier from a CAN bus can be read, scaled, processed and stored.

## LAN / TCP

The LAN interface can be used to transmit all measurement data online, including software channels, at high speed via intranet or internet. Any networked PC can then access the ProfiMessage devices via this interface. There are also additional TCP services such as NTP, FTP, HTTP and SFPMP etc. available. The device's internal data memory can also be read out via LAN.

## USB interface (Master)

The USB interface can be used to transmit data from the internal memory to USB memory stick.

## Expansion bus

The expansion bus enables up to 20 slave devices to be connected to the master device.

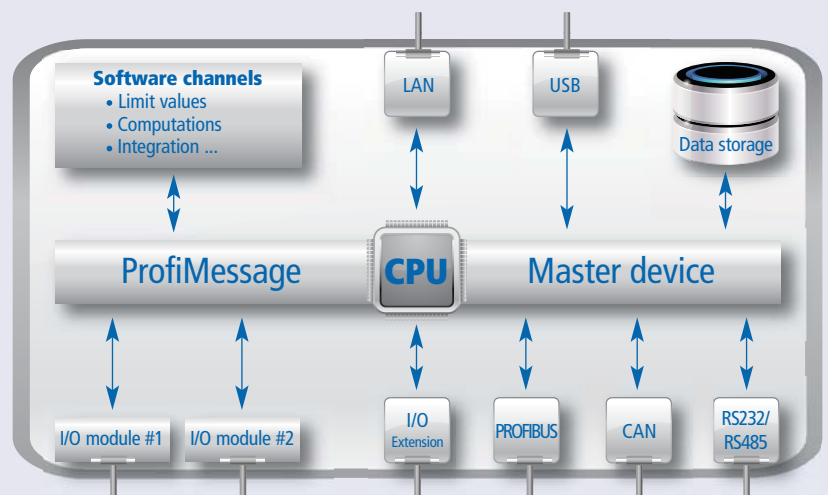







ProfiMessage interfaces and functions

# Extended functions

## Intelligent and secure

Monitoring and automation tasks can be realised using ProfiMessage software channels. Software channels are pre-defined function modules that users can generate and configure per mouse click and then subsequently run within

the device. All functions are performed autonomously by the powerful internal processor. This guarantees full operational security for the ProfiMessage device.

Online analysis		Description	Examples
 Calculation channel	Performs computations between channels. Functions include: basic arithmetic operations, trigonometry, binary and boolean functions	Calculating temperature differences between two input temperatures	
 Averaging channel	Performs computations of moving and triggered averages	Average and highly sensitive signals from thermocouples	
 Edge counter	Counter for impulses (high, low and reset-functions)	Counting energy impulses (kWh)	
 Differentiator	Computes changes taking place over time periods	Gravimetric feeders in laboratories	
 Integrator	Numerical integration over time periods	Computing volumes from flows	
 Totalling channels	Time-independent addition of measurement data	Totalling of analog measurement data	
 Linearization	Corrective computation for non-linear sensors	Linearization of a specific application PTC sensor	
 Operating hours counter	Accumulates hour times from digital signal high levels	Determining uptime / downtime patterns for machinery	
 Statistic channel	Performs computations of moving and triggered statistics (min, max, variance, standard deviation)	Determining the maximum value of an experiment	
 Stop watch	Measures time between two events	Determining switch times for valves or hermal switches	
Monitoring		Description	Examples
 Threshold value	Generates an event for a threshold violation (over / under runs, consistency, hysteresis, line monitoring)	Alarm for overrun of a storage temperature	
 Batch alarm	Generates an alarm from multiple digital input channels	Alarms from various parts of an installation are summarized in one notification	
 Wake-up	Generates impulses for absolute chronological events (once a day, week, month ...)	Determining daily statistics for production	
 Status monitoring	Evaluates status information from measurement data and generates alarms	Alerting of wire-breaks in an mA-signal	
 System monitor	Displays system information (CPU load, free memory capacity ...)	Alerting for a full data memory	
Automation		Description	Examples
 Setpoint channel	Automates setpoint curve with reset, stop and start triggers	Automatic temperature gradient for a climate chamber	
 FlipFlop channel	RS, JK, D, FlipFlop	Records digital states	
 Impuls generator	Generates cyclical impulses	Energy counter reset, time synchronized every 15 mins	
 Logic channel	AND, OR ...	Boolean conjunctions for any digital signal	
 Timer channel	Timer functions (on / off delay)	Time delayed start of an experiment	
 Marker channel	Records constants and parameters	Process constant	

# ProfiMessage – Vibration measurement

## Universal vibration measurement device

ProfiMessage devices are also suitable for vibration monitoring and damage diagnostics applications. Vibration and process data can be acquired, stored and monitored. Typical measurements are acceleration, velocity and wave length. The ProfiSignal software enables measurement data to be portrayed, analyzed and managed for alarms. The Vibro ProfiSignal option, specially developed for vibration measurement enables the data portrayal in FFT or Orbit diagrams.

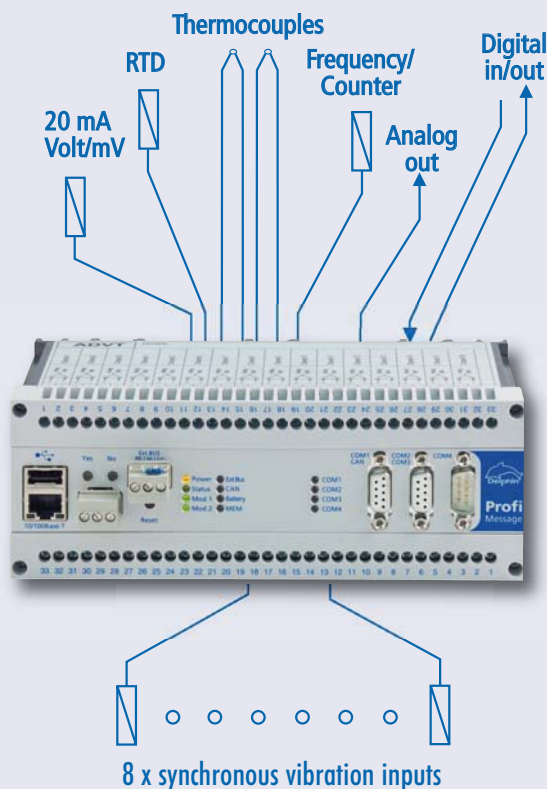

## Flexible applications

Vibration measurement technology can be universally deployed. ProfiMessage devices are monitoring hydro turbines and generator air gaps for vibrations in installations around the world. The devices are also being used in damage diagnostic systems for drives, shafts and bearings on ships. An especially innovative application is the acquisition and monitoring of combustion chamber and gas turbine vibrations (humming). Message devices in mobile vibration measurement cases are being used around the world as well as are being used in permanent test stand installations.

## Various Applications for vibration measurement technology

- Shaft vibration
- Bearing vibration
- Combustion chamber vibration / humming
- Vibrations in housings
- Generator air gap
- Mobile vibration measurement
- Gear box vibrations

## Product features

- Synchronous, parallel data acquisition from up to 16 vibration signals
- DSP supported signal processing
- Computation and monitoring of FFT spectrum directly in Message device
- Characteristic value calculation (Peak-Peak, Gap ...), order analysis
- Characteristic value monitoring / alarm management (text messaging, email)
- Notification to main control system via PROFIBUS-DP or Modbus RTU / TCP
- Trend and analysis of measurement data using ProfiSignal software via network
- Evaluation using orbit, FFT, cascade and x(y) diagrams
- Calculation of envelope frequency spectrum and vibration velocity

## Hardware AMDT

The I/O module AMDT is the base module for vibration measurement. A ProfiMessage master device can accommodate up to two AMDT modules. AMDT is equipped with eight synchronous analog inputs, rotation inputs and digital outputs. AMDT modules can be operated in conjunction with other I/O modules from the ProfiMessage series.

## Practical technology

Delphin's standard version vibration measurement technology already has many practical functions. Its modular design enables adaptation to any size of application. Message devices can acquire vibration signals such as speed, acceleration and displacement as well as typical units of measurement such as pressure, temperature, flow and rotation. The Message device's compact, industrial-grade design, with detachable clamps and rail mountings, make them easy to install into cabinets and housings.

Hardware and software from Delphin provide complete systems for all vibration measurement requirements.



## Vibration module functions

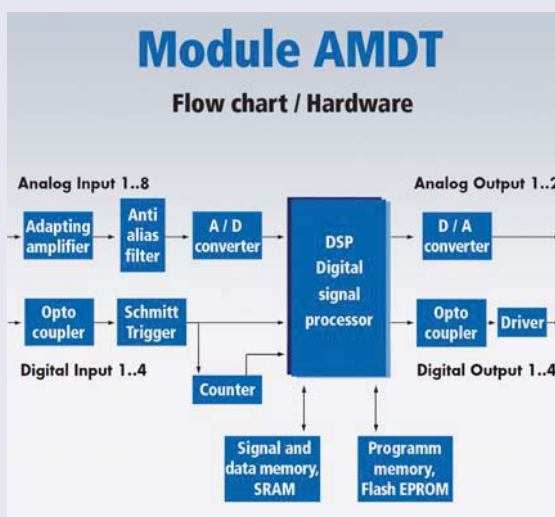

### Inputs / outputs per module

- 8 parallel analog inputs
- Synchronous sampling, flexible triggering
- 160 KHz sampling rate, adapted anti-alias-filter
- 4 digital inputs, potential isolation, 2 inputs with frequency counters, 3.5 V high-level
- 4 digital outputs, potential isolated, switching voltage max. 50 V@2.5 A

### FFT / frequency spectrum

- Flexible parametering of frequency range, line numbers and frequency resolution
- FFT algorithms for 1024, 2048, or 4096 points or with 400, 800, or 1600 lines
- Standard 'Hanning', and 'Flat Top' window functions
- Averaging of frequency spectrums

### Characteristic values

- Arithmetical average, TRMS
- Peak-Peak, min / max values
- Amplitude / frequency of the main vibration
- Amplitude / phasing of synchronous shaft vibrations and dual-shaft synchronous vibrations
- Selective frequency band evaluation

# ProfiSignal – Software for measurement

## Complete system

ProfiSignal is a complete software system for data acquisition, analysis, visualisation and automation. The software is very user-friendly and combines professional functionality with easy operation.

ProfiSignal provides a clear and logical overview of all measurement systems: whether for single or multi-thousand channel applications. For new users, ProfiSignal is quick to learn. ProfiSignal is modular, scalable and available in three versions: Go, Basic and Klicks. Each version has backward compatibility for operability, data files and application projects.

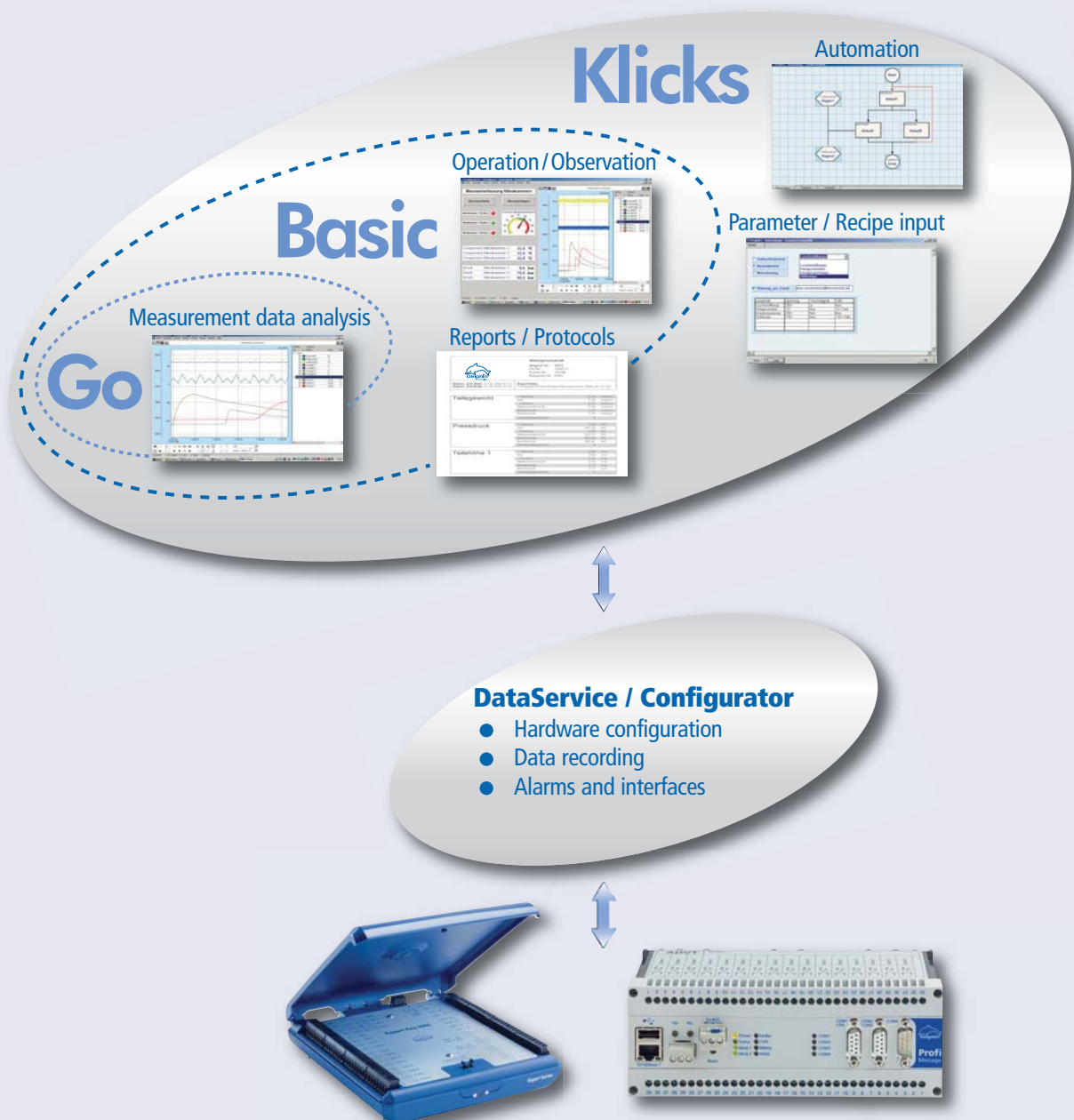



# and test engineering

## Overview of software modules

### ProfiSignal Go

ProfiSignal Go is a runtime system enabling measurement data to be displayed and analyzed in just three steps. The Go version is able to analyze large volumes of offline and online data.

- Data acquisition and recording
- Data analysis and calculations
- Online and offline trends
- Data export and print outs

### ProfiSignal Basic

ProfiSignal Basic, like ProfiSignal Klicks, is a developmental system for generating custom systems with visualization and trend functions.

- Operation and observation
- Process visualization
- Report generation

### ProfiSignal Klicks

ProfiSignal Klicks is software for test automation and the programming of control systems.

- Automating test stands and process control systems
- Automating evaluation and analysis functions
- Generating parameter graphs
- Selective frequency band evaluation

ProfiSignal Go	ProfiSignal Basic	ProfiSignal Klicks
<b>Data acquisition</b>	<b>Monitoring</b>	<b>Automation</b>
<b>Runtime system</b>	<b>Development system</b>	<b>Development system</b>
Online trends	Logger substitute	Test stands
Historical measurement data	Fault analysis	Technical installations
Alarm tables	Acquisition of fault data	Laboratory automation
Data export	Damage diagnostics	Automated processes
	Quality assurance	Acquisition of operational data
	Remote monitoring	SQL interface
		Comprehensive reporting

Typical applications for Go, Basic and Klicks

## Measurement database included

Measurement hardware configuration takes place with the DataService / Configurator software included in ProfiSignal. The software configures hardware and software interfaces, and records data securely and permanently.

The DataService saves measurement data to a database. Any ProfiSignal version on the network can then access these databases and immediately display their data as trends.

### ProfiSignal DataService / Configurator

- Configures hardware
- Records data to data files
- Records data to databases
- Calculation functions
- Monitoring functions
- Event alarms (email, text message, fax)
- User management and password protection systems
- Standard software interfaces (OPC, Modbus ...)
- Customized software interfaces (OCX, .NET ...)

# ProfiSignalGo – Data acquisition and

## Monitoring and analysis

ProfiSignal Go enables measurement data to be saved, displayed as trends, analyzed and exported in ASCII and CSV formats. Just a few simple steps are required to go from measurement channels to trend output.

Online and offline measurement data can be continuously evaluated in trends. Go offers the following diagrams:

- y(t) diagram
- y(x) diagram
- Characteristic curve
- Oscilloscope
- Digital logical analysis



The diagrams can be run simultaneously. There are no restrictions on either the volume of measurement data or the number of channels.

## Limitless trend options

The DataService enables uninterrupted portrayal of online and offline measurement data. Users can zoom in on archived data during a measurement run. This function is unique and especially valued by users.

ProfiSignal Go is also capable of processing large data volumes. The Go recording algorithm ensures readability of all information at the highest zoom settings. Peaks remain visible even for extremely long time ranges. This function facilitates the searching of maximum/minimum values.

## Efficient recording of measurement data

ProfiSignal Go includes the complete DataService software. This software enables convenient data storage and archiving functions. Measurement data can be stored to files or to databases.

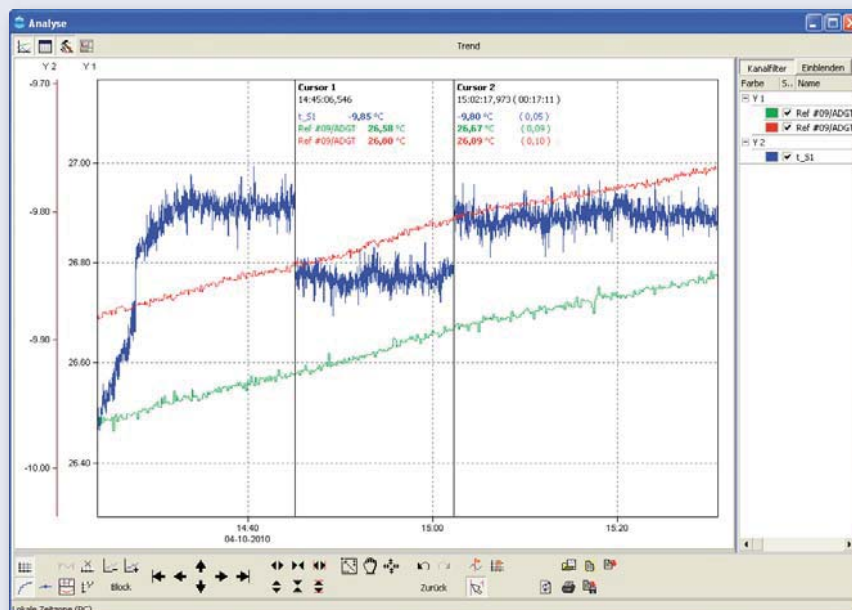

ProfiSignal Go trend

# analysis

## Product features

- Monitoring and analysis of any type of measurement data
- Recording tests to separate files
- Permanent storage to databases
- Portrayal in trends
- Uninterrupted switching to offline mode
- ASCII export as CSV files
- Print out or EMF export
- Offline calculation functions
- Statistical evaluation
- Analysis with cursor functions to  $\mu\text{sec}$
- Recording of diagram configurations
- Evaluation of digital signalling processes
- Alarm functions for digital events
- Email or fax notification of alarms

## Various Applications from ProfiSignal Go

- Mobile and fixed data acquisition
- Laboratory data acquisition
- Measuring at installation
- Measuring service data
- Process data acquisition and analysis
- Fault diagnostics and recorder functions
- Experiments and testing

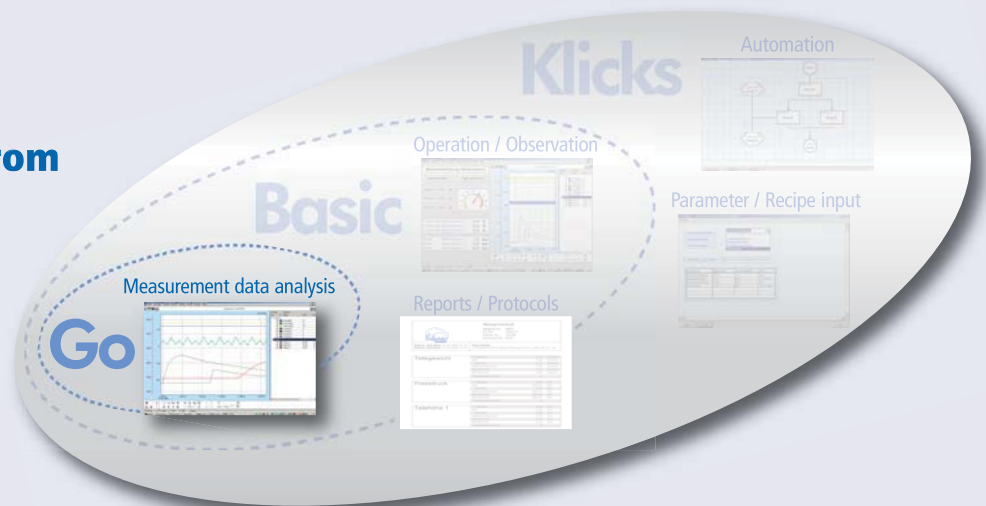

## A range of interfaces

ProfiSignal Go is for use with Delphin's Message and Expert series. ProfiSignal Go is also equipped with an OPC Server and Client, a Modbus TCP interface and a programming interface. Drivers are also available for all the standard data acquisition systems, e.g. VXI, HBM, NI, PSI and the ADAM modules. The modular design enables inexpensive programming interfaces.

## Alarm table – monitoring and alerting

In conjunction with the DataService, ProfiSignal Go provides a diverse range of alarm and monitoring functions. In the event of alarms, digital outputs can be switched and users notified via email. An alarm table provides an overview of current and archived alarm events.

# ProfiSignal Basic – Operation and

## Customized applications

ProfiSignal Basic is a complete software package to meet user requirements in the fields of measurement data acquisition, operation and monitoring. Basic provides ready to use modules for:

- Acquiring measurement data
- Monitoring processes
- Operating and observing test stands
- Generating reports
- Basic automation

ProfiSignal Basic is designed to be fully configurable and compatible for continuous processes (e.g. operational data acquisition) as well as batch processes (e.g. data from experiments and trials). Basic includes basic automation functions for measurement procedures. Basic includes every function from ProfiSignal Go.

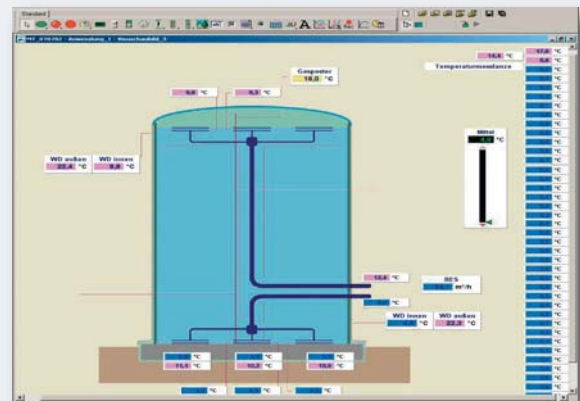

ProfiSignal Basic visualization

## Operation and monitoring

A large range of operation and observation objects enable the simple generation of process visualization diagrams. These are available with analysis functions. Operating and monitoring functions can be organized into viewing images. Even inexperienced users are able to quickly generate their own applications. These are generated in development mode and can then be switched for operation to runtime mode.

## Development environment



## Runtime mode

## Continuous evaluation

The integrated DataService, especially suitable for large amounts of data, enables historical data to be immediately displayed on the screen at high-level resolution. Evaluation can take place from the company network or from anywhere in the world. Measurement data can be stored over extremely long periods of time. For vibration analysis or for the evaluation of transient events, data can easily be acquired and stored at kHz-sampling-levels. Recorders allow data acquired for specific tasks to be stored in separate files on the PC.



**Applications are generated with ProfiSignal in the development mode and switched to runtime mode for operation.**

# observation

## Product features

- Runs multiple applications simultaneously
- Diverse operating and observation functions
- Monitoring and analysis of any measurement data
- Recording data from experiments to separate files
- Permanent data storage to databases
- Portrayal of online and offline data in trends
- Basic functions for automation
- Formula editor
- ASCII data export in CSV files
- Custom-made reports
- Offline calculation functions
- Statistical evaluation
- Analysis with cursor functions to  $\mu\text{sec}$  resolution
- Recording of diagram configurations
- Evaluation of digital signalling processes
- Alarm functions for digital events
- Email or fax notification in alarm event

## Various Applications from ProfiSignal Basic

- Mobile and fixed data acquisition
- Laboratory data acquisition
- Test stand measurement technology
- Clean room monitoring
- Visualization of operational data
- Process data acquisition and analysis
- Experiments and tests
- Machine visualization



## Measurement data analysis

A range of diagrams are available for measurement data analysis.  $Y(t)$  diagrams enable high resolution portrayal of continuous processes over long time periods. This is particularly beneficial for quality assurance and fault diagnostic systems. Both slow and fast signals can be combined in one graph. A formula manager enables online and offline computations of measurement data as well as the recording and portrayal of computed results. Complex efficiency computations as well as basic temperature averages are simple to perform.

## Reports and protocols

As well as measurement data and computed data, a report may also contain objects such as  $y(t)$  diagram (trends),  $y(x)$  diagram (characteristic curves), tables, illustrations, input data and text. Reports can be generated and archived automatically according to time or events. This is an ideal tool for quality assurance, quality certification and accounting purposes.

# ProfiSignal Klicks – Complete with

## All in one

Klicks is the complete package with the entire ProfiSignal functions in one system. Klicks includes a structure diagram in which processes can be graphically portrayed as procedure blocks. Each block is created according to "programming by selection". Programming takes place at the click of the mouse. The learning of a programming language is unnecessary. ProfiSignal includes blocks for the following tasks:

- Data acquisition
- Operating and observation
- Report generation
- Automation
- Parameter management

ProfiSignal Klicks enables test stand and laboratory automation, measurement data evaluation and accounting and requires no programming knowledge required.

To complete the range of functions there are input templates for test parameters and recipes and documentation functions for protocols. Klicks provides users with a single package to generate their own automating and testing applications. ProfiSignal Klicks contains all the functions from ProfiSignal Basic and ProfiSignal Go.



ProfiSignal Klicks visualization

## Test parameters and recipes

A parameter input screen is an important tool in test engineering and laboratory automation applications, and allows for the input of test parameters, recipes and batch data. Complete input and option templates can easily be generated, as can process visualization and viewing screens. ProfiSignal's SQL option makes it possible to import parameters directly from company databases. This reduces working times and eliminates input errors.

## Process control

Klicks has been developed for technicians, engineers and scientists who want to generate their own processing procedures but without having to invest extensive time into programming skills. The Klicks automation language does not require the learning of a programming instruction set

nor the typing in of instructions and commands. This eliminates any syntax errors from occurring. Full focus can then be given to the process control – a structure chart can be generated at just a few mouse-clicks.

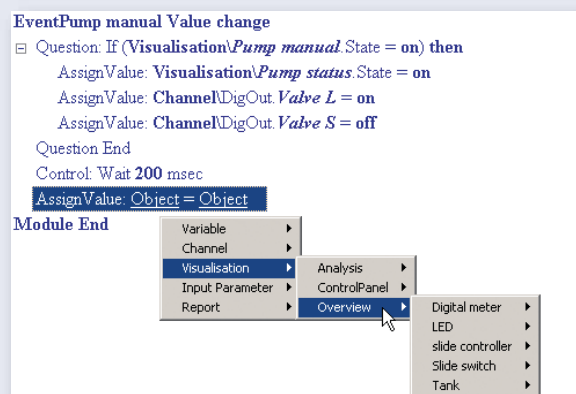

Program module with Klicks

# automation

## Product features

- Synchronous or asynchronous execution of multiple applications
- Automation functions and structure charts
- Includes Klicks programming language
- Diverse operating and observation functions
- Monitoring and analysis of any measurement data
- Recording to data files and databases
- Parameter data management
- Display of online and offline data as trends
- Formula editor
- Custom reports
- Offline calculation functions
- Full trend functions

## Various Applications from ProfiSignal Klicks

- Mobile and fixed data acquisition
- Automation of test procedures
- Generation of process control
- Automation of measurement requirements
- Laboratory automation
- Product testing
- Experiments and testing

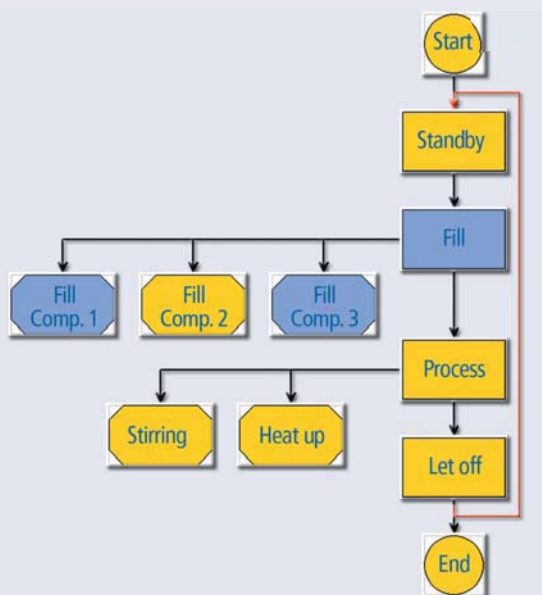
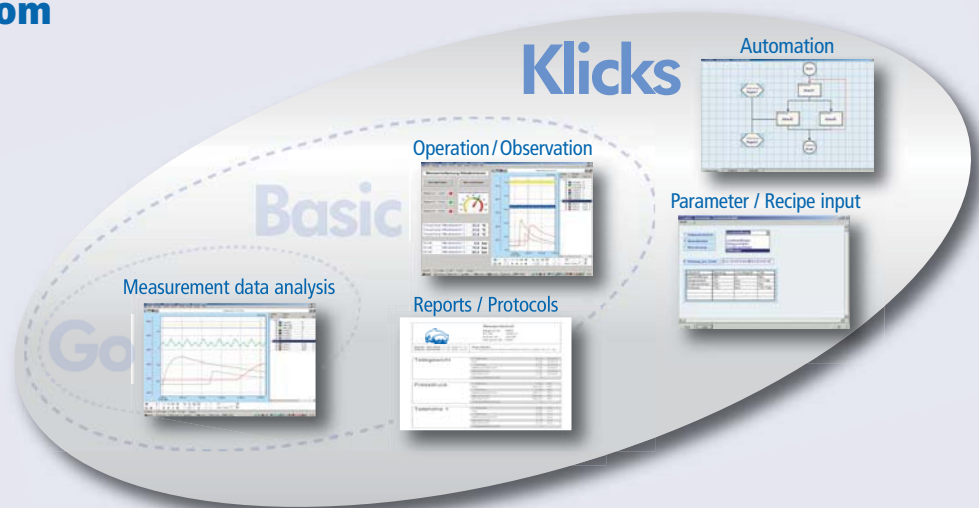

## Structure chart

The structure chart is made up of special symbols that serve as containers for programming instructions. Double clicking on a symbol opens an instruction editor. This gives users the option of maintaining and updating applications or completed programs, even years into the future.

# ProfiSignal – Interfaces, Runtime

## ProfiSignal interfaces

ProfiSignal is equipped with optional interfaces for connecting external software and hardware. Drivers are available for data exchange with NI LabVIEW™ and DASyLab™. Sensors and other control and measurement systems can be connected to ProfiSignal via OPC Server / Client and Modbus TCP. An API interface enables ProfiSignal to be integrated into high-level languages. OCX and .NET interfaces are also available.

ProfiSignal can also be connected to external hardware. A range of drivers are available to connect external hardware. The following are examples of supported hardware: VXI, PSI, HBM, WinSocket and many others.

## Product features

- Multiple interfaces for external hardware and software
- High transfer rates supported
- Compatible with latest software versions
- Simple installation
- Full documentation

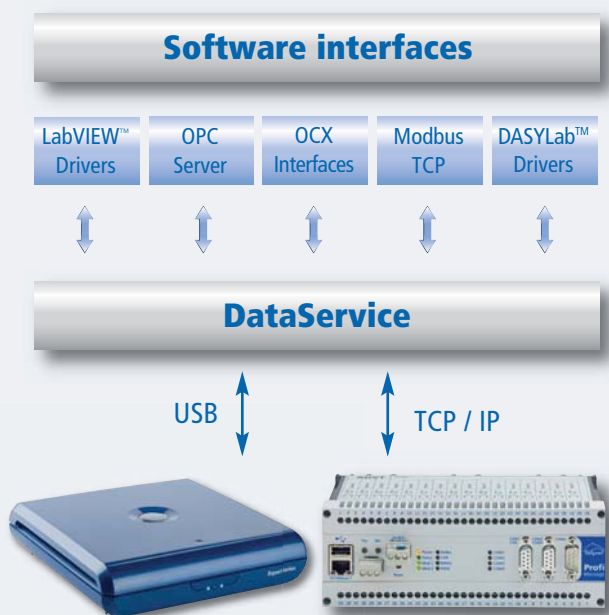

## ProfiSignal Runtime

Once a ProfiSignal project has been completed in development mode, a Runtime licence then enables its operation. ProfiSignal Runtime licence contains only ProfiSignal's runtime mode. Only completed projects that have been transferred to runtime mode can be started. Runtime mode is not intended for the creating of new projects. Runtime includes all ProfiSignal options available in the development mode.

## Product features

- Manipulation safe running of ProfiSignal projects
- Projects contained within one file
- Easy to copy applications to multiple PCs
- Inexpensive solution for OEM applications
- No development mode required



Technical specifications are available on page 47.



# Viewer and options

## ProfiSignal Viewer

The ProfiSignal Viewer enables offline analysis of measurement data files and reports generated by ProfiSignal. ProfiSignal Viewer is suitable for users who require only data analysis or export, e.g. to ASCII or Excel files, and not the system's full functioning or online data features. The Viewer includes ProfiSignal options for trend diagrams and characteristic curves, e.g. cursors, markers, export and statistical functions.

## Product features

- Offline analysis and export of measurement data
- Offline analysis and processing of reports
- Diagrams, e.g. trends, characteristic curve, orbit and FFT Orbit, FFT diagrams
- Diagram functions, e.g. cursor, export, markers, statistics etc.
- Dynamic reporting with access to all measurement data plus time-stamps
- Display and processing of reports

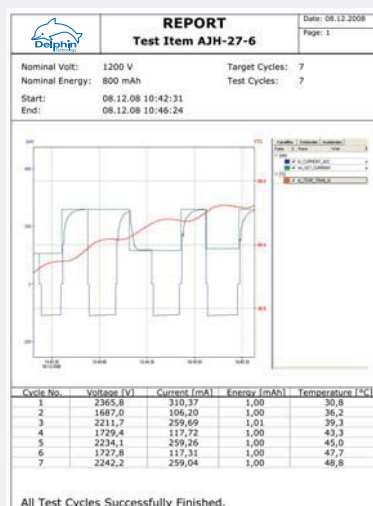

Report extract of QM standard

## ProfiSignal options

A range of options are available for ProfiSignal Basic and Klicks. Single or multiple options can be acquired depending on user requirements.

### ① Vibro option (Basic and Klicks)

The vibro option has been specially developed for vibration measurement applications:

- Online / offline portrayal, evaluation of measured data using the AMDT vibration I/O module
- FFT, cascade, time signal and orbit diagrams
- Process measurement data and vibration data within a single system

### ② AlarmManagement option (Basic und Klicks)

The alarm management option records, visualizes and manages alarms. Email or fax messages can be sent in the event of an alarm:

- Any number of alarms can be set up using the DataService
- Alarm acquisition takes place with date and time recording at millisecond resolution
- Alarm notification via digital outputs using sound data formats or visualization objects
- Alarm history in the form of alarm lists

### ③ SQL option (for Klicks only)

The SQL option links ProfiSignal data to company database or ERP systems:

- Integrated SQL interface for data exchange with other databases, e.g. for test sample parameters
- Connection to ProfiSignal via ODBC-functioning enabling read / write of data

# ProfiSignal – Option Vibro and

## Vibration visualization and analysis

The ProfiSignal Vibro option extends existing ProfiSignal functions with FFT, cascade, time signal and orbit diagrams and enables the portrayal of vibration data that has been acquired and calculated from the AMDT vibration module.

## Fully integrated into ProfiSignal

The full integration of vibration analysis into ProfiSignal means Delphin systems can be used to simultaneously portray process data and vibration data as characteristic values in digital / analog displays or in graph format.

## Unlimited documentation

A ReportGenerator enables user-defined documentation for vibration data as FFT or cascade graphs as well as envelope spectrum curve analysis. Orbit and trend graphs provide for the graphical representation of kinetic shaft orbits including maximum  $S_{max}$  deflection and angular position / phase.

## Extensive range of functions in one system

The ProfiSignal Vibro option provides individual shaft vibration diagnosis in gas / steam / hydro turbines, superchargers and motors. The Vibro option can also be used for bearing vibration analysis in electric motors and roller bearings.

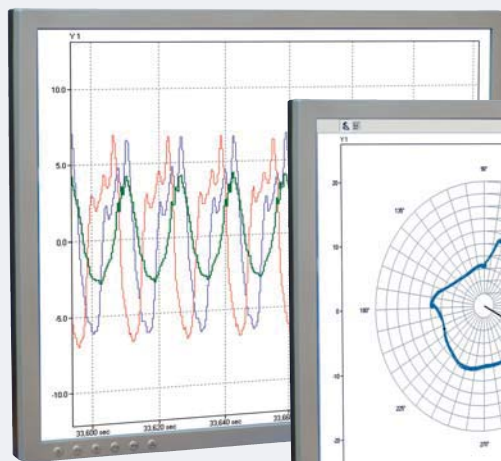

Time-signal-diagram

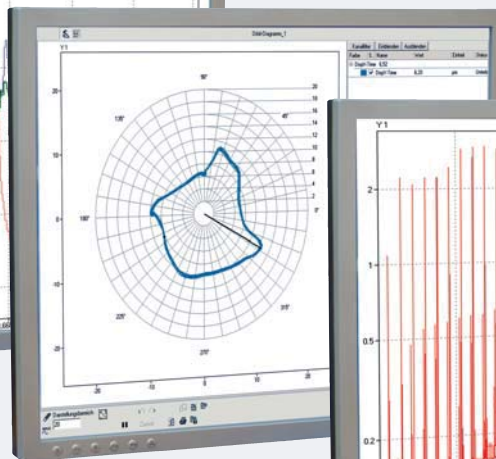

Orbit-diagram

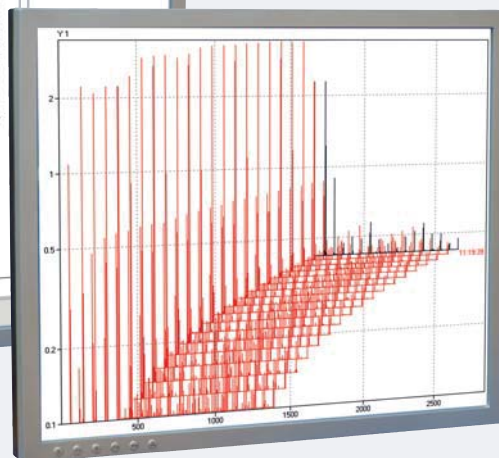

FFT-cascade-diagram

# Option AlarmManagement

## Data acquisition, monitoring and alarm functions

The ProfiSignal AlarmManagement option provides important additional functions concerning monitoring and alarms. Modern monitoring systems should not only acquire data – they must also be able to issue alarms when faults occur. An obvious requirement here is a user management system with graded levels of access rights. ProfiSignal AlarmManagement functions also include alarm audits and uninterrupted alarm recording.

Alarm Time	Alarm Gone Time	Priority	Alarmicon	Alarm Text	Alarm Source	State	Duration Time	Confirmation	Confirmation Pass
27.11.2008 14:36:24.515		3	Group Hydraulic	Flow Overrun 60 l/min	Flow	Active			
27.11.2008 14:36:20.650	27.11.2008 14:41:49.730	1	Group Hydraulic	Pressure 2 Overrun 10 psi	Pressure 2	Done			
27.11.2008 14:36:17.402		2	Group Hydraulic	Pressure 1 Overrun 230 psi	Pressure 1	Active			
27.11.2008 14:07:22.296		2	Group Temperature	Water Overrun 90 °C	Water	Active			
27.11.2008 14:07:22.296		1	Group Temperature	Tubing Underrun 500 °C	Tubing	Active			
27.11.2008 14:07:22.296	27.11.2008 14:36:07.564	3	Group Hydraulic	Flow Overrun 60 l/min	Flow	Done			
27.11.2008 14:07:22.296	27.11.2008 14:36:11.837	1	Group Hydraulic	Pressure 2 Overrun 10 psi	Pressure 2	Done / Confirmed	27.11.2008 14:07:22.296	John Lew	Value checked
27.11.2008 14:07:22.296	27.11.2008 14:36:14.576	2	Group Hydraulic	Pressure 1 Overrun 230 psi	Pressure 1	Done / Confirmed	27.11.2008 14:07:22.296	John Lew	check ok
27.11.2008 14:07:22.296	27.11.2008 14:07:22.296	1	Group Temperature	Water Overrun 90 °C	Water	Aborted / Confirmed	27.11.2008 14:07:22.296		
27.11.2008 14:07:22.296	27.11.2008 14:07:22.296	2	Group Temperature	Water Overrun 90 °C	Water	Aborted / Confirmed	27.11.2008 14:07:22.296		
27.11.2008 14:07:22.296	27.11.2008 14:07:22.296	1	Group Hydraulic	Pressure 1 Overrun 230 psi	Pressure 1	Aborted / Confirmed	27.11.2008 14:07:22.296		
27.11.2008 14:07:22.296	27.11.2008 14:07:22.296	2	Group Temperature	Temp 1 Underrun 500 °C	Tubing	Aborted / Confirmed	27.11.2008 14:07:22.296		
27.11.2008 14:07:22.296	27.11.2008 14:07:22.296	1	Group Hydraulic	Flow Overrun 60 l/min	Flow	Aborted / Confirmed	27.11.2008 14:07:22.296		
27.11.2008 14:07:22.296	27.11.2008 14:07:22.296	1	Group Hydraulic	Pressure 2 Overrun 10 psi	Pressure 2	Aborted / Confirmed	27.11.2008 14:07:22.296		
27.11.2008 14:07:22.296	27.11.2008 14:07:22.296	1	Group Hydraulic	Pressure 1 Overrun 230 psi	Pressure 1	Done			

Alarm table

## Alarm classification

Alarm classifications are the foundation for a practical and workable alarm management system. Specific rules, e.g. on limit values, can be defined as required and then allocated varying priority levels.

## Action and reaction

Each rule has a pre-set action. This might be notification sent via text-message, fax or email, or a warning sent to a main control system, or a digital output switch to shutdown a process or issue a sound alarm.



## Visualization

Alarm tables can be easily incorporated into an existing visualization. The large range of configuration options provide an easily manageable alarm system, even for systems with many channels.

Corresponding trend

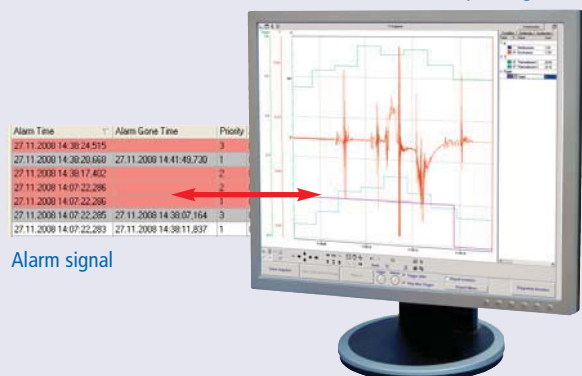

Alarm signal



**Alarm outcomes are linked directly to the corresponding trends.**

# Complete systems – mobile measurement

## Measurement case provides mobility

Users appreciate the benefits of the mobile measurement case because of its unrestricted flexibility and detailed, high-resolution measurement data, e.g. for fault analysis. An integrated data logger (16 GB) can record up to 2 billion measurement values including time stamps; the data logger can operate independently, with or without PC support. Universal connectors are available for measuring mA and mV signals, thermocouple and RTD sensors as well as vibration sensors.

Internal signal conditioning simplifies working procedures and saves on the need for expensive measurement transducers or any other additional equipment. Galvanic isolation and differential inputs prevent interference from process signals or earth loops. The user-friendly ProfiSignal PC software enables acquired measurement data to be visualized, analyzed, and archived. There are also functions for the monitoring, operating and automating of entire or partial processes.



Vibration measurement case

## Vibration measurement case

The vibration measurement case is intended for practitioners in vibration measurement. With just one case, it is possible to acquire displacement, speed and acceleration signals. This option is also available for process signals.



Universal measurement case

## Universal measurement case

The universal measurement case is made of an extremely robust synthetic material and can cope with any bumps or knocks during transport or operation. The measurement case can acquire 25 analog signals as required. Connection can be made with 4 mm connectors, screw terminals, thermo-connectors, BNC or user-defined connecting points. There is also an option for digital input acquisition. Power measurement is also possible.



**The measurement cases shown here are just two examples from the Delphin range. We can supply any measurement case to your specific requirements.**

# case and 19"-measurement devices

## 64-channel thermocouple measurement device

The 64-channel thermocouple measurement device (64-KTM) is a compact measurement system in a 19"-housing and intended for high-precision measurement of 64 thermocouples of any type. The 16 GB data memory acquires and saves the measurement results independently and over months. A TCP interface to a network is available for online measuring. The measurement channels are high resolution and can achieve, depending on thermocouple and measurement area, an absolute accuracy of < 0.2 K.



Front and back of a 64-KTM

A 64-KTM master can be extended at any time with 64-channel slave devices, with the same 19"-housing, therefore providing a total of over 5,000 measurement channels. The device includes the ProfiSignal Basic software for measurement data archiving, and online / offline measurement data analysis. A driver is also available for all current measurement technology software or OCX driver. In developing the device, particular attention was given to cold junction compensation and high-precision.

## Universal testing device

The universal testing device (UPG) enables automated testing of plant, machinery and components. Thermocouples, RTDs and other sensors can be directly connected; there is also a measuring capability for electrical AC/DC data. Setpoint and control channels provide for the automation of testing procedures.

The UPG includes a 19" tabletop housing design with a measurement data display as well as connection sockets for AC/DC data U, I and P (3-phase). On the rear side are 24 analog inputs for connecting thermocouples (any type); 8 of these have increased galvanic isolation of up to 650 VDC for potential-based temperature measurement. Parallel to these are 8 channels wired to 4 mm laboratory connectors enabling thermocouple, RTD, resistance, mA signals or DC volt signals to be measured. There are also 14 digital inputs, 18 digital outputs as well as 4 analog inputs and 4 analog outputs for control tasks.

230 V loads can be directly connected. Frequency and impulse counters up to 30 kHz are available. There are rear side screw terminals for these channels.

The device can perform measurement and control tasks entirely autarchic and independently, which is of particular benefit in endurance testing. It has an 16 GB internal memory with the user interface being a normal PC with network compatibility. The user-friendly ProfiSignal software is included in the delivery.



Front and back of a UPG



**The products shown here are just a few examples from Delphin's complete range of 19" products. We can supply custom-made 19" measurement systems to meet your specific requirements.**

# Industry solutions

## Tried and tested turnkey applications

Product development requires a multitude of tests to deliver information on quality assurance and conformity to safety and other standards. Delphin systems enable automation of the norms, standards, and directives involved in these testing and evaluation procedures.

Users of Delphin products benefit from its many years of experience and the expertise it has acquired in developing industry solutions. Delphin's standard entry products can deliver individual solutions that guarantee a long term return on your investment. The following are examples of industry solutions currently in operation.



### **LPG – luminaire testing complying to EN 60598**

You will find more information in the detailed LPG brochure.



## Heating, cooling, and air-conditioning systems

Reducing emissions requires a multitude of high precision and complex measuring procedures. These are being performed on heating systems and their components (e.g. furnaces, boilers, hot water supplies, heat exchangers, and solar systems).

The measuring systems in operation are highly flexible and enable the connection of fluid and condensate scales, gas meters, and sensors (e.g. thermocouples, RTDs, flow meters, and pressure converters).

Testing can be run, monitored, and evaluated from a PC via integrated Ethernet interfaces.

Once testing is completed, the automatically produced reports and documentation can be read, modified, and converted into PDF format with an easy to use report viewer function. Measurement data and trend reports can be exported at a mouse click to standard software packages such as MS Office.

## Testing procedures

- Furnace data acquisition from oil, gas, and wood burning systems
- Boiler efficiency measurement
- Monitoring operation and determining standard efficiencies
- Determining performance indicators, continuous rating, and storage capacities
- Measuring start-up pressures
- Charging and heat-up patterns within storage systems
- Testing of regulating and thermostat systems

## Household appliances

A wide range of tests are required to ensure the quality of household appliances and their components and product liability legislation has increased these requirements. Lead times from product development to product launch are becoming increasingly shorter making automated testing procedures even more important. Automation is required for product certification during the development phase and for endurance testing in product quality and reliability.

Delphin testing systems in the household appliance industry feature a full range of functions and a high level of automation. All functions are available from a single desk-top and range from test sample conditioning through to automated evaluation. The turnkey solutions include software and hardware tailored to individual requirements.



## Testing household appliances

- Extraction hood testing according to EN 60335
- Testing of temperature controllers/ switches etc.
- Mechanical and electrical endurance testing
- Development phase measurements
- Energy labelling and classifying

## Switches and components

Delphin switch-testing systems can test micro switches (used in household appliances), thermostats, temperature regulators, and power switches.

Flexible systems of hardware and software enable both endurance testing during development and end testing.



Complete testing system

## Switch testing

- Turnkey system with intuitive software
- Multiple, independent testing units within a single system and PC
- Fully automated testing and automation
- Time and cost savings in development and certification
- Testing of contact resistances, temperatures, electrical values
- Operating of mechanical equipment at the test periphery
- Documenting quality of test sample and third-party components

# Services

## Applications development by Delphin

The versatility of Message devices and the powerful ProfiSignal software means Delphin products are suited to small, simple applications as well as large, complex systems. Moreover, Delphin products can be used in virtually any branch and application field. ProfiSignal software is a particularly powerful tool and is equipped with many practical functions. Users praise its structuring and simplicity.

Many Delphin users develop their own applications; others make use of Delphin's application development service. Our engineers have been working with the products for many years and know every detail. If you use our services for application development, we will guarantee you smooth and trouble-free development of your system – from engineering through to training.



**Benefit from Delphin's turnkey application development or choose specific services and consultancy expertise to complement your own system development.**

## Services in application development

- System specification preparation
- Development of a complete ProfiSignal application
- Design and realization of visualization views for operating and observation
- Creation of input templates
- Development and testing of Klicks programming
- Layout and operation of reports and output with measurement results
- Message device configuration
- Development of serial drivers
- Development of specific software modules
- Design of cabinet constructions
- Preparing full documentation
- Software installation and software configuration
- Factory acceptance tests
- Installation and system commissioning
- User training
- Maintenance and servicing



# Application development

## Completed projects

### Test stand automation – compressor testing

At a pump manufacturer, simultaneous and automated production testing takes place at seven parallel test stands. Each test stand can be started and stopped from a PC. Test output is transferred via ODBC to a production database. The test commences with parameter input. The user selects from predefined test samples and determines the type of sample to be tested. The recording and saving of measurement data then occurs at the press of a button. A color-change on a digital display indicates data that is outside the permitted range.

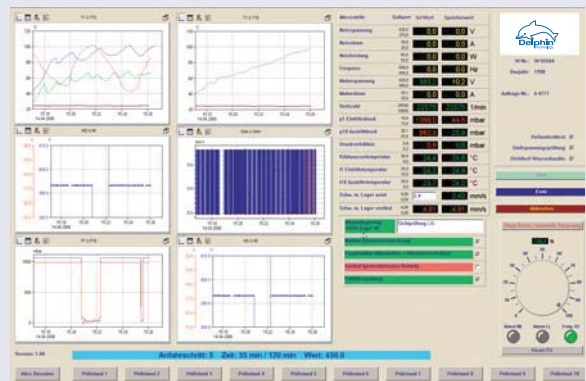

User interface with trends and operation elements

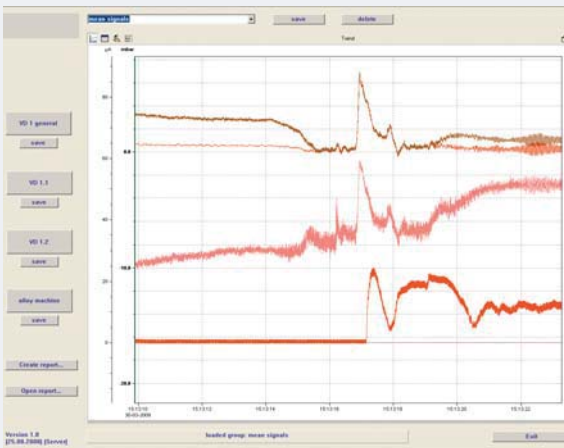

Individual trend diagram

## Cabinet construction

Delphin provides the design, manufacture, testing and documentation of individual customer solutions for cabinet construction. It includes, alongside the Message devices, all other necessary components – from power supplies through to relays. Delphin produces small housing cabinets as well as complete cabinet systems.



## Completed projects

### Environment simulation and endurance testing – climatic cabinets

Eight cooling and four climatic cabinets are being operated in a chemicals research department. The cabinets contain samples that are subjected to interference through environmental simulation. A TopMessage device saves temperatures from an RTD sensor, with the limit parameters being set at a PC. A user management system has been configured within ProfiSignal Klicks. Depending on user rights, users may view current temperatures and trends and adjust limit values. Hard-copy documentation takes place automatically.

# Calibration

## Calibration service

Every Delphin measurement system is supplied as calibrated according to ISO 9001 and DKD\*.

Following purchase, Delphin also provides a re-calibration service and, if required, the re-adjustment of devices and equipment.



**For both on-site calibration and calibration at Delphin, the customer receives calibration certification according to DKD\* standards.**

\*Deutscher Kalibrierdienst (German calibration service)

## Calibration service from Delphin

Calibration of devices at Delphin is recommended when the user has the opportunity of sending the devices to us. Just agree a date with our calibration team and send us your devices.

## On-site calibration

Major setups may be difficult to dismantle to enable off-site calibration. We therefore offer on-site calibration of your equipment. We have mobile, modern calibration instruments that allow us to perform calibration directly on your equipment and, if necessary, to make adjustments.



Mobile calibration system from Delphin

## User benefits for on-site calibration:

- Minimum downtimes because devices remain on-site
- Minimum interruption in measurement processes because devices are calibrated in series
- Fixed calibration dates
- No time or costs regarding dismantling, postage and re-installation
- No transportation risks
- Devices remain in their tempered environment

# Training – Installation – Service

## Training – general or specific

Delphin training courses inform you, with specialist and practical knowledge, of the many different applications that can be realized using ProfiSignal and Message devices. Training courses are designed according to the needs and requirements of the participants. We offer basic courses, advanced courses as well as custom-designed courses.

Training can take place either at Delphin or on-site. There are benefits in having training events exclusively intended for your staff – we can then tailor the courses directly to your specific needs and requirements.

## Installation

Our services also include work acceptance tests and partial or full installation. We agree on a date between you and one of our experienced application engineers; this will guarantee a smooth and time-saving integration of the measurement technology into your existing hardware and software environment. You want to perform the installation yourself? We can also offer you support and advice here.

## Service packages

Our services extend far beyond the installation and user training of your measurement applications. Delphin customers are long-term customers and also benefit from our premium service packages concerning

- Maintenance and repair
- Service hotline
- Update service

We are constantly updating and extending our service provision. Visit us at [www.delphin.com](http://www.delphin.com) or call us to find out what we currently offer.



# Expert Key – Technical specifications

## Expert SERIES

Device type	100	200
Analog inputs	14	28
Current source for RTD	4	8
Sensor types	mV, mA, thermocouples, RTD, Pt100(0)	
Resolution	18 Bit	
Sampling rate	100 kHz	
Measurement range	$\pm 100, 200, 500$ mV; $\pm 1, 2, 5, 10$ V	
Compensation	yes / 1	yes / 2
Galvanic isolation	yes	
Analog outputs	2	2
Resolution	16 Bit	
Max. output rate	50 Hz	
Output voltage / current	0 ... 10 V / $\pm 10$ V / 0 ... 20 mA / 4 ... 20 mA / $\pm 20$ mA	
Galvanic isolation	yes	
Digital inputs ...	8 to 12	1
Input voltage / current	5 V, 12 V, 24 V, 48 V / 2,7 mA	
Logic voltage level	< 2,5 V = low / > 3 V = high	
Max. input frequency	1 MHz or 10 kHz	
Galvanic isolation	yes	
... with counter function	8 to 12	1
Counter resolution	64 Bit	
Max. input frequency / resolution	1 MHz / 1 $\mu$ s or 10 kHz / 100 $\mu$ s	
Measurement range	0,1 Hz ... 1 MHz or 10 kHz	
Max. input voltage / current	5 V, 12 V, 24 V, 48 V / 1,5 mA	
Galvanic isolation	yes	
Digital outputs ...	4 to 8	1
Max. switching voltage / current	30 V / 1 A or 40 V / 0,75 A or 50 V / 0,6 A	
Max. output rate	10 Hz	
Galvanic isolation	yes	
... with PWM function	4	1
Duty cycle	1:100 ... 1:500	
Max. switching voltage / current	30 V / 1 A or 40 V / 0,75 A or 50 V / 0,6 A	
PWM basic frequency	5 Hz ... 10 kHz	
Galvanic isolation	yes	
<b>General technical information</b>		
Sensor connection	via screw terminals with 0,14 ... 2,5 mm <sup>2</sup> openings	
Power supply	External power supply	
Max. power input	6 Watt	
Power supply	9 ... 24 VDC	
Temperature range	0 ... 50 °C	
Environmentally friendly	RoHS conform	
Interfaces: USB or Ethernet	USB 2.0 high speed / LAN 100 BaseT	
Expert Key L 100/200 dimensions	50 x 185 x 215 mm	
Expert Key L 100/200 weight	750 g	
Expert Key C 100/200 dimensions	57 x 280 x 208 mm	
Expert Key C 100/200 weight	1.500 g	
Expert Key P 100/200 dimensions	495 x 135 x 305 mm	
Expert Key P 100/200 weight	6.500 g	
Expert Key M 100/200 dimensions	406 x 330 x 174 mm	
Expert Key M 100/200 weight	5.100 g	

# LogMessage – Technical specifications

## LogMessage

<b>Analog inputs</b>	
Voltage range	± 156 mV ... ± 10 V
Current range	0/4 ... 20 mA
Thermocouples	any, all types, integrated temperature compensation; resistance thermometer Pt100(0), NTC and linear resistance to 10 k (not LM300 / LM700)
Potential isolation	750 VDC for system and supply; 400 VDC between channels at LM500, 110 VDC between channels in other types
Resolution	24 Bit (≈7 decimal places) precision: V, mA 0,01 % from accumulated value Pt100 0,1 K; Pt1000 0,1 K thermocouple 0,1% from accumulated value
<b>Analog outputs</b>	
Resolution	16 Bit
Potential isolation	750 V
Output signal	0/4 ... 20 mA at maximum burden 650 Ω
<b>Digital inputs</b>	
Potential isolation	2,5 kV
Measurement range	low: 0 ... 1,5 VDC@0 ... 1,5 mA / high: 3,5 ... 90 VDC@2 mA
<b>Frequency / counter inputs</b>	
Potential isolation	2,5 kV
Measurement range	low: 0 ... 1,5 VDC@0 ... 1,5 mA / high: 3,5 ... 90 VDC@2 mA
Measurement frequency	up to 30 kHz to TTL-level
<b>Digital outputs</b>	
Potential isolation	2,5 kV
Switching voltage	max. 50 VDC@2,5 A
<b>Data storage</b>	
Standard size / measurement data	Storage partitionable, data compression standard: 1 GB; max. 128 Mio. measurement values
<b>Interfaces</b>	
Serial	RS232/485/422 interfaces, adjustable
Physical equipment COM 1	9-pole sub-D connector, DIN EN ISO 19245-1
Protocols	customer specific, modem connector, Modbus RTU Master / Slave
Physical equipment COM 2	9-pole sub-D connector, DIN 41652, chapter 1 (ISO 4902)
Ethernet	RJ45 (8-pole STP-socket), 10 BaseT (Twisted Pair, 10 Mbps, half-duplex), Protocols: TCP/IP, HTTP, SMTP, SNMP, Modbus TCP Client / Server
<b>General technical information</b>	
Weight	1 kg
LogMessage dimensions	200 x 73 x 118 mm
LogMessage mounting	Rail mounting DIN EN 50023 or screw fixing
LogMessage signal connections	Deatchable screw terminals, 33 terminals (2-rows), lead protection, connector cable, max. 2,5 mm <sup>2</sup>
Temperature range	-20 ... 60 °C
Power supply	12-36 VDC / 12-28 VAC eff. / ± 10%, for AMDT 18 VAC/DC power input for master device: < 10 Watt
LC-Display	For servicing purposes: 4 lines à 15 characters 4 cursor keys, Enter, Esc, Reset keys Displays configuration data, channel name, scaled and lineared measurement data

# ProfiMessage – Technical specifications

## ProfiMessage / ProfiLab

Analog inputs	
Voltage range / Current range	$\pm 156 \text{ mV} \dots \pm 10 \text{ V} / 0/4 \dots 20 \text{ mA}$
Thermocouples	any, all types, integrated temperature compensation; resistance thermometer Pt100(0), NTC and linear resistance to 10 k (not ADVT)
Potential isolation	750 VDC for system and supply; 400 VDC between channels at ADGT module 2.0; 650 VDC between channels at ADGT module 3.0; 110 VDC between channels in other modules
Resolution	24-bit ( $\approx 7$ decimal places) precision: V, mA 0,01 % v. accumulated value Pt100 0,1 K; Pt1000 0,01 K; thermocouple 0,1% from accumulated value
Analog outputs	
Resolution / potential isolation	16 Bit / 750 V
Output signal	0/4 ... 20 mA at maximum burden 650
Digital inputs	
Potential isolation	2,5 kV
Measurement range	low: 0 ... 1,5 VDC@0 ... 1,5 mA / high: 3,5 ... 90 VDC@2 mA
Frequency / counter inputs	
Potential isolation / measurement range	2,5 kV / low: 0 ... 1,5 VDC@0 ... 1,5 mA / high: 3,5 ... 90 VDC@2 mA
Measurement frequency	up to 30 kHz to TTL-level
Digital outputs	
Potential isolation	2,5 kV
Switching voltage	max. 50 VDC@2,5 A
Data storage	
Standard size / measurement data	Storage partitionable, standard: 500 MB; max. 250 million measurement values
Max. size / measurement data	16 GB; up to 1 billion measurement values
Serial interfaces	
Physical equipment COM 1 / COM 2	RS485, 9-pole sub-D connector, DIN EN ISO 19245-1
Physical equipment COM 3 / COM 4	RS232, 9-pole sub-D connector
Protocols COM 1 / COM 2	PROFIBUS DPV1 Slave (both interfaces), also redundant, according PNO 2.212 V1.2
Protocols COM 1 ... COM 4	Modbus RTU Master / Slave, custom specific protocols
Ethernet	RJ45 (8-pole STP-socket), 100 BaseT Protocols: TCP/IP, HTTP, SMTP, NTP, Modbus TCP Client / Server
USB	USB 1.1. for configuration and memory download
CAN	9-pole sub-D connector, protocols: CAN, RAW; Baudrate: 50 K ... 1 MBaud
Module bus	
Physical equipment	3-pole Phoenix plugs; internal bus for connecting additional modules
Baud rate / length	1 MBaud (adjustable) / up to 10 m (1 MBaud)
General technical information	
ProfiMessage dimensions	200 x 73 x 118 mm
ProfiMessage weight	1 kg
ProfiMessage mounting	Rail mounting DIN EN 50023 or screw fixing
ProfiMessage signal connections	Deatchable screw terminals, 33 terminals (2-rows), lead protection, connector cable, max. 2,5 mm <sup>2</sup>
ProfiLab dimensions	226 x 145 x 180 mm
ProfiLab weight	1 kg
ProfiLab signal connections	up to 64 4 mm laboratory connectors, gold plated
Temperature range	-20 ... 60 °C
Power supply	12-36 VDC / 12-28 VAC eff. / $\pm 10\%$ , at AMDT 18 VAC/DC power input for master device: < 10 Watt

# ProfiSignal – Technical specifications

Modules and functions	ProfiSignal version			
	Go	Basic	Klicks	Viewer
DataService / Configurator				
Data recording (database)	X	X	X	
Message device configuration	X	X	X	
Interface management	X	X	X	
User management and password protection	X	X	X	
Scheduler – programmable data transfer	X	X	X	
Calculation, integrator channels, monitoring channels	X	X	X	
Diagrams (online and offline)				
y(t) diagram	X	X	X	X
Logic diagram for signal analysis	X	X	X	X
y(x) diagram	X	X	X	X
y(x) color diagram	X	X	X	X
Measurement data export – ASCII and CSV	X	X	X	X
Diagram as EMF export	X	X	X	X
Graphical elements				
Analog display		X	X	
Digital display		X	X	
LEDs		X	X	
Block display		X	X	
Background images and animated .gif files		X	X	
Operating and control elements				
Buttons		X	X	
Switches		X	X	
Text input		X	X	
Radio buttons		X	X	
Dropdown boxes		X	X	
Slide controls		X	X	
Manual controls		X	X	
Programming				
Test parameter management			X	
Report programming			X	
Process control and automation functions			X	
Timer and event management			X	
Table management			X	
Adapter channels			X	
Application variables			X	
Application tables (2D and 3D)			X	
Other functions				
Data recorders with trigger functions	X	X	X	
Screen print out function		X	X	
Set point curves		X	X	
Date and time display		X	X	
Offline calculation channels	X	X	X	
Global alarm tables		X	X	
Vibro option				
FFT and cascade diagrams		X	X	X
Orbit diagram		X	X	X
AlarmManagement option				
Configurable alarm table		X	X	X
Fault diagnostics		X	X	



ISO 9001  
Certified



Delphin Technology AG  
Lustheide 81  
51427 Bergisch Gladbach · Germany

Phone +49 2204 97685-0  
Fax +49 2204 97685-85  
info@delphin.de · www.delphin.com

