

Think Automation and beyond...



HG1F

Operator Interface



IDEC CORPORATION

Clear and legible display of up to 300 × Functions comparable to large operator

Wide & Bright High Resolution



Clear

- 500 cd/m² high-contrast LCD (monochrome)
(luminance according to LCD manufacturer's specifications)
- Clear display of 300 × 100 pixels
- 16 brightness levels
- Windows® fonts can be displayed.

A choice of three frame colors



Light Gray

Dark Gray

Silver

Easy

- WindO/I-NV2 software for easy screen design (Ver. 3.1 or higher)
- Compatible with HG2F/3F/4F/2S
- Various communication drivers and user communication functions enable direct connection to PLCs, barcode readers, printers, and other peripherals.

100 pixels interfaces

HG1F 4.6 inch Operator Interface

Analog touch panel enables flexible screen layout

Objects can be expanded infinitely from the minimum switch size of 16 × 16 pixels and placed anywhere on the screen.



Thin body — Only 35.3mm deep behind the panel

Small, thin housing fits into narrow mounting spaces. Vertical installation and scrolling text display are also possible.



Multi-lingual capabilities

Many languages can be displayed, such as English, simplified and traditional Chinese, Korean, European languages, central European languages, Baltic, and Cyrillic.

High-speed 1:N communication

One host can connect a maximum of 16 HG1F, HG2F, HG3F, HG4F, and HG2S operator interfaces in an O/I link network.

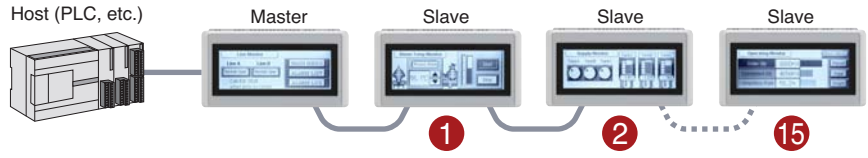
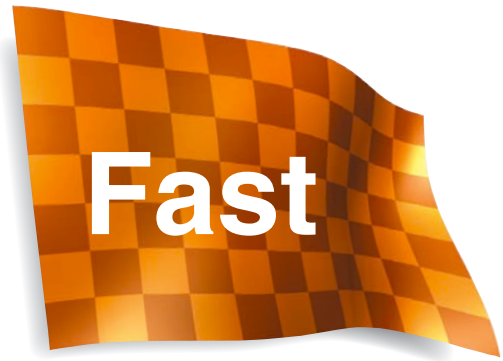

When using the HG1F RS-485/422 version as a slave, the O/I link unit is not needed.

- RISC processor is employed for a high internal processing speed.
- Quick response in operation and display
- 1 MB user memory size (including optional fonts)

Interface Specifications

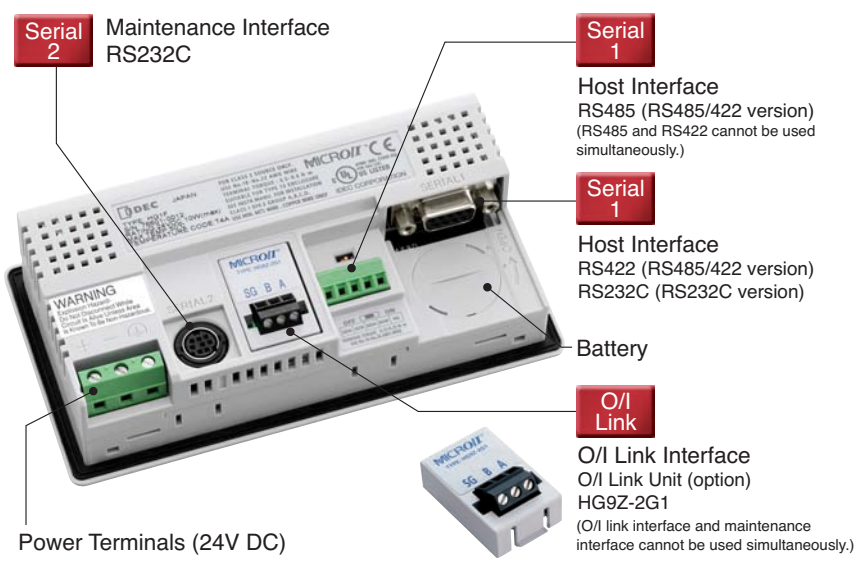
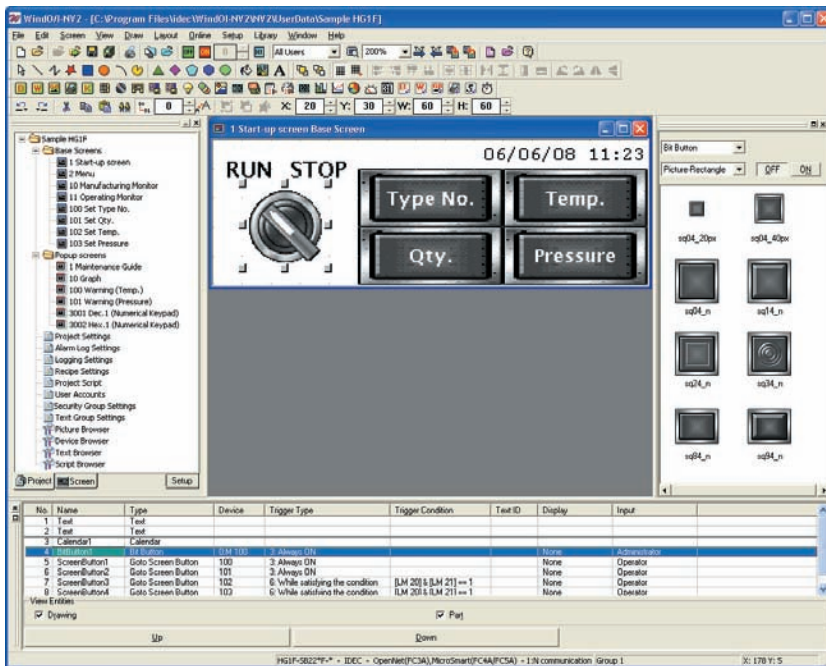

Photo shows the RS485/422 version equipped with the optional O/I link unit. The RS232C version does not have the host interface RS485 communication port.

WindO/I-NV2 software guides you to create almost any screen you can imagine.



Easy-to-view Work Space

Project list, object list, and parts list can be displayed on the screen while editing the program, confirming operation, and debugging the program, greatly reducing time and labor.

Basic and Advanced modes for easy and precise settings

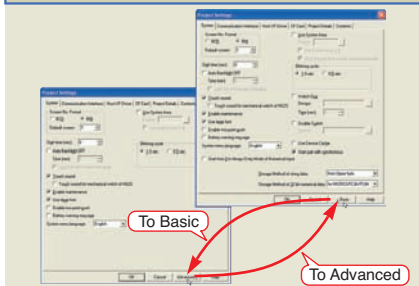

Two modes are available for project settings to lay out parts: Basic mode for easy programming and advanced mode for more detailed settings to present professional graphic design.

Parts and Symbol Factory as standard provision

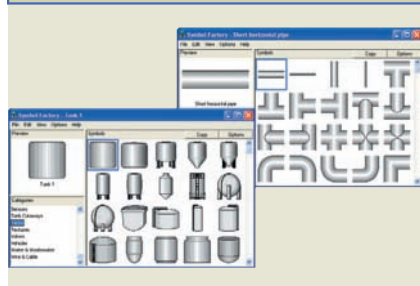

Frequently-used 'Parts' are provided in the parts list and can be easily selected and configured. Moreover, various graphic images can be selected from the 'Symbol Factory' which is a graphic library of 5000 images useful for professional design.

Drag and drop operation for easy screen layout

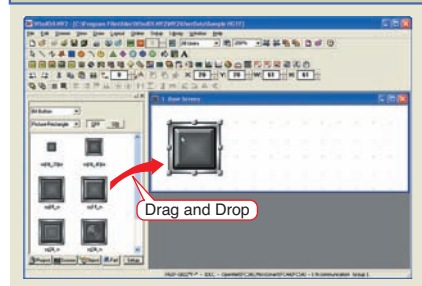

Any parts in the parts library can be simply dragged and dropped onto the screen. Special skills are not required.

User-friendly debugging functions

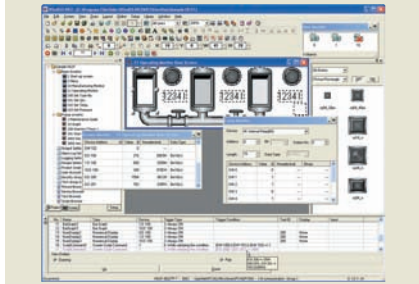

Debugging functions include 'Preview' to confirm the design on the WindO/I-NV2 screen, 'Simulation' to confirm operation connected to the HG1F, and 'Debug' to test operation with the HG1F connected to the host. While monitoring devices on the screen, the screen design and parts settings can be modified.

Powerful functions comparable to large and medium O/I's

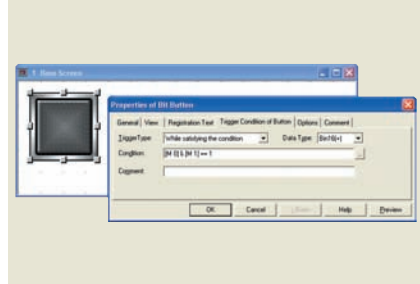

In addition to 'Script' and 'Recipe' functions, parts configurations can be set and changed in the 'Property' dialog box. Operability is inherited from the IDEC HG series displays and screen data can be reused for the HG1F to ensure coordination of the entire control system.

Multilingual capabilities intended for global applications

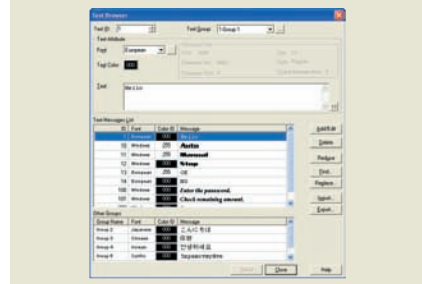

Texts, legends, and messages used on the screen can be saved in language groups and all texts can be switched to another language at once. Various Windows fonts can be displayed to enhance the appearance.

System Requirements

- OS Windows 95 (OSR2 or later), 98, Me, NT4.0, 2000, XP
- CPU Pentium 200 MHz or higher
- RAM 64 MB
- Hard Disk Space 150 MB minimum (including manual)
- Graphic SVGA (800 × 600) or higher
- Others Mouse, CD-ROM drive

Windows is a registered trademark of Microsoft Corporation in USA and other countries.

Applicable PLCs

Manufacturer	Series	Applicable System (CPU Module)	Link Unit	Manufacturer	Series	Applicable System (CPU Module)	Link Unit			
IDEC	FA-3S	PF3S-CP12, PF3S-CP13	PF3S-SIF2, PF3S-SIF4, PF2-CLA	Siemens	S7-200	CPU212, CPU214, CPU215, CPU216, CPU221, CPU222, CPU224, CPU226, CPU226XM	Not used (connect to CPU module)			
		PF3S-CP11, PF3S-CP11T	PF2-CLA			S7-300	CPU313, CPU314, CPU315, CPU315-2DP, CPU316, CPU318	CP-340, CP-341		
	FA-2J	PF2J-CPU1	S7-400				CPU412, CPU414, CPU416, CPU416F-2, CPU417	CP-440, CP-441		
	OpenNet Controller	FC3A-CP2			Not used (connect to CPU module)	Keyence	KV-700, KV-1000	KV-700, KV-1000	Not used (connect to CPU module)	
	MicroSmart	FC4A-C10R2, FC4A-C10R2C	Not used (connect to CPU module)		Visual KV		KV-10, 16, 24, 40	Not used (connect to CPU module)		
		FC4A-C16R2, FC4A-C16R2C, FC4A-C24R2, FC4A-C24R2C	FC4A-PC1, FC4A-PC3		Conventional KV		KV-10, 16, 24, 40/80	Not used (connect to CPU module)		
		FC4A-D20K3, FC4A-D20S3, FC4A-D20RK1, FC4A-D20RS1, FC4A-D40K3, FC4A-D40S3	Not used (connect to CPU module)		Sharp	New Satellite JW	JW-21CU, JW-22CU, JW-31CUH/H1, JW-32CUH/H1, JW-33CUH/H1/H2/H3	JW-21CM		
		FC5A-C10R2, FC5A-C10R2C, FC5A-C16R2, FC5A-C16R2C, FC5A-C24R2, FC5A-C24R2C	FC4A-PC1, FC4A-PC3				JW-50CU/CUH, JW-70CU/CUH, JW-100CU/CUH	JW-10CM		
	FC5A-D16RK1, FC5A-D16RS1, FC5A-D32K3, FC5A-D32S3	Not used (connect to CPU module)	JW-22CU, JW-70CU/CUH, JW-100CU/CUH, JW-32CUH/H1, JW-33CUH/H1/H2/H3				Not used (connect to CPU)			
	Mitsubishi	MELSEC-A	A1N, A2N, A3N		AJ71C24, AJ71C24-S3/-S6/-S8, AJ71UC24	Hitachi	S10mini	S10mini	Not used (connect to CPU module)	
A1SH-S1			A1SJ71C24-R2, A1SJ71UC24-R2, A1SJ71C24-R4, A1SJ71UC24-R4	JTEKT (Toyoda Machine)	TOYOPUC-PC2J	PC2J	Not used (built-in computer link)			
A2CCPUC24			Not used (connect to CPU module)	Toshiba Machine Works	TOYOPUC-PC3J	PC3J, PC3JD, PC3JG	Not used (built-in computer link)			
A0J2, A0J2H			A0J2-C214-S1	GE Fanuc Automation	Series 90-30	CPU331, CPU341, CPU350, CPU351, CPU352, CPU360, CPU363, CPU364, CPU374	IC693CMM311			
A2A, A3A, A2U, A3U, A4U			AJ71C24-S6/-S8, AJ71UC24					VersaMax	Nano, Micro (14, 23, 28 points)	Not used (connect to CPU module)
A2N			Not used (connect to CPU module)							
A1SJH, A1SH, A2SH, A2C, A0J2H			Not used (connect to CPU module)	AROMAT	FP series	FP0, FP1, FP10, FP10SH, FP2, FP2SH, FPΣ	Not used (connect to CPU module)			
A2A, A3A, A2US, A2USH			Not used (connect to CPU module)					Yaskawa	Machine Controller	MP920, MP930, MP2300
A2U, A1SH-S1			Not used (connect to CPU module)	Koyo	DirectLogic DL405	D4-430, D4-440, D4-440	Not used (connect to CPU module)			
Q00CPU, Q01CPU			Not used (connect to CPU module)					FANUC	Power Mate	Power Mate-MODEL D
Q02CPU, Q06HCPU, Q12PHCPU	QJ71C24, QJ71C24N, QJ71C24N-R2	Yokogawa	FACTORY ACE	FA-M3 (F3SP05, F3SP20, F3SP21, F3SP25, F3SP30, F3SP35, F3SP38, F3SP53, F3SP58, F3FP36, F3BP20, F3BP30)	F3LC11-1N, F3LC11-2N					
Q02CPU, Q02CPU-A mode	Not used (connect to CPU module)					Fuji Electric	FREX-PC	NB1, NB2, NB3, NJ-CPU-E4, NJ-CPU-A8, NJ-CPU-B16, NS	Not used (connect to CPU module)	
FX0, FX0N, FX1, FX2, FX2C, FX0S, FX1S	Not used (connect to CPU module)	Allen-Bradley	PLC-5	All PLC-5 models compatible with 1770-KF2	1770-KF2					
FX2N, FX2NC, FX1N, FX1NC	Not used (connect to CPU module)					SLC-500 (Half Duplex)	SLC5/03, SLC5/04	Not used (connect to CPU module)		
FX2N	FX2N-232-BD, FX2N-422-BD, FX2N-485-BD	Micro Logix (Full Duplex)	Micro Logix 1000, Micro Logix 1200	Not used (connect to CPU module)						
FX1N	FX1N-232-BD, FX1N-422-BD, FX1N-485-BD									
FX3UC	Not used (connect to CPU module)									
OMRON	SYSMAC-C	C500, C500F, C1000H, C2000, C2000H	C120-LK201-V1, C120-LK202-V1, C500-LK201-V1, C500-LK203	Fuji Electric	FREX-PC	NB1, NB2, NB3, NJ-CPU-E4, NJ-CPU-A8, NJ-CPU-B16, NS	Not used (connect to CPU module)			
		C1000HF	C500-LK203							
		C200HS	C200H-LK201, C200H-LK202							
		C200HE, C200HG, C200HX	C200H-LK201, C200H-LK202, C200HW-COM02/COM04/COM05/COM06, C200HW-COM03/COM06							
		C120, C120F	C120-LK201-V1, C120-LK202-V1							
		C20H, C28H, C40H, C60H	Not used (connect to CPU module)							
		CQM1H, C200HS-CPU21/23/31/33	Not used (connect to CPU module)							
		C200HE-CPU42, C200HG-CPU43/63, C200HX-CPU44/64	Not used (connect to CPU module)							
		CPM1, CPM1A, CPM2A	CPM1-CIF01, CPM1-CIF11							
		CPM2A	Not used (connect to CPU module)							
SYSMAC-CS1	CS1G, CS1H	Not used (connect to CPU module)								
SYSMAC-CJ1M	CJ1M	Not used (connect to CPU module)								
Allen-Bradley	PLC-5	All PLC-5 models compatible with 1770-KF2	1770-KF2							
		All PLC-5 models	Not used (connect to CPU module)							
		SLC5/03, SLC5/04	Not used (connect to CPU module)							
	Micro Logix (Full Duplex)	Micro Logix 1000, Micro Logix 1200	Not used (connect to CPU module)							

HG1F Operator Interface

Clear legible display of 300 × 100 pixels

Multiple functions comparable to larger operator interfaces

- High-contrast monochrome LCD, super bright 500 cd/m² (luminance according to LCD manufacturer's specifications)
- 16 adjustable brightness levels
- All Windows® fonts can be displayed.
- High-performance CPU ensures quick response in operation and display.
- Analog touch panel enables flexible screen layout.
- User communication functions enable connection to barcode readers and other peripherals.
- High-speed O/I link function enables connection to a maximum of 16 HG units to a host, using optional O/I link unit HG9Z-2G1.
- Thin housing style — only 35.3mm deep behind the panel
- WindO/I-NV2 software is used for easy screen design.
- Compatible with IDEC HG2F, HG3F, HG4F, and HG2S displays.
- Multilingual capabilities, such as English, simplified and traditional Chinese, Korean, and central European languages.
- UL, c-UL listed (except silver bezel), EN compliant



Types

Display Screen	Operation Type	Maintenance Interface	Host Interface	Housing/ Bezel Color	Type No.	Remarks
4.6-inch STN monochrome LCD	Touch screen	RS232C	RS232C	Light gray	HG1F-SB22BF-W	UL, c-UL, CE
				Dark gray	HG1F-SB22BF-B	UL, c-UL, CE
				Silver	HG1F-SB22BF-S	CE
			RS485/422	Light gray	HG1F-SB22YF-W	UL, c-UL, CE
				Dark gray	HG1F-SB22YF-B	UL, c-UL, CE
				Silver	HG1F-SB22YF-S	CE

Note: Each HG1F operator interface is supplied with four mounting clips SLD-K02 and one battery HG9Z-XR1.

• Options

Name	Type No.	Ordering Type No.	Description	Length	Connector to the Host	Mode
PLC Connection Cable (Note 1)	HG9Z-XC183		For IDEC's MicroSmart, OpenNet Controller, port 2	3m	Mini DIN 8-pin	RS232C
	FC4A-KC1C		For IDEC's MicroSmart, port 1	5m	Mini DIN 8-pin	RS232C
	HG9Z-XC115		For IDEC's FA-3S SIF2	5m	Dsub 9-pin female	RS232C
	HG9Z-XC245		For Mitsubishi FX direct connection	5m	Mini DIN 8-pin	RS422
	HG9Z-XC255		For Mitsubishi A/QnA direct connection	5m	Dsub 25-pin female	RS422
	HG9Z-XC265		For Mitsubishi Q series direct connection	5m	Mini DIN 6-pin	RS232C
	HG9Z-XC145		For Mitsubishi computer link unit	5m	Dsub 25-pin female	RS232C
	HG9Z-XC155		For OMRON link unit	5m	Dsub 25-pin female	RS232C
	HG9Z-XC203		For Mitsubishi computer link unit	3m	Dsub 9-pin female	RS232C
	HG9Z-XC213		For OMRON CPU unit RS232C interface (except C20H, 28H, 40H)	3m	Dsub 9-pin female	RS232C
Maintenance Cable	HG9Z-XCM22		D-sub 9-pin female connector to connect to computer (2m long)			(Note 2)
Protective Sheet	HG9Z-1D	HG9Z-1DPN05	For protecting the HG1F screen (5 pcs/pack)			
O/I Link Unit	HG9Z-2G1		Communication unit for O/I link			
Configuration Software	HG9Y-ZSS2W		WindO/I-NV2 on CD (English/Japanese/Chinese compatible) without a printed manual PDF files of English/Japanese/Chinese manuals are stored on the CD.			
Manual	HG9Y-B596		English hardware/software manual			

Note 1: For cable connection diagrams, see the host interface manual which is stored on the WindO/I-NV2 CD.

Note 2: Computer link cable 4C (FC2A-KC4C) for IDEC's MicroSmart and OpenNet Controller is also applicable.

• Replacement Parts

Name	Type No.	Ordering Type No.	Description
Replacement Backlight (CCFL)	HG9Z-1FB		One backlight is supplied with HG1F.
Mounting Clip	SLD-K02	SLD-K02PN10	10 pcs/pack (four pieces are supplied with HG1F)
Replacement Battery	HG9Z-XR1		Lithium battery CR2032 (one battery is supplied with HG1F)

HG1F Operator Interface

General Specifications

Rated Power Voltage	24V DC
Power Voltage Range	20.4 to 28.8V DC
Power Consumption	10W maximum
Power Inrush Current	20A maximum
Allowable Momentary Power Interruption	10 ms minimum
Dielectric Strength	1,000V AC, 10 mA, 1 minute between power and FG terminals
Insulation Resistance	50 MΩ minimum between power and FG terminals (500V DC megger)
Backup Battery	CR2032 lithium primary battery Life approx. 4 years (25°C)
Operating Temperature	0 to 50°C
Operating Humidity	10 to 90% RH (no condensation)
Storage Temperature	-20 to +60°C
Storage Humidity	10 to 90% RH (no condensation)
Pollution Degree	2 (IEC 60664-1)
Corrosion Immunity	Atmosphere free from corrosive gases
Vibration Resistance (damage limits)	10 to 20 Hz amplitude 0.625 mm, 20 to 55 Hz acceleration 9.8 m/s ² , 2 hours per axis on each of three mutually perpendicular axes
Shock Resistance (damage limits)	147 m/s ² , 11 ms, 5 shocks on each of three mutually perpendicular axes
Noise Immunity	Fast transient/burst test, Common mode: Level 3, Power terminals: ±2 kV, Communication line: ±1 kV (IEC 61000-4-4)
Electrostatic Discharge	ESD-3 (RH-1), Level 3, (contact ±6 kV, air ±8 kV) (IEC 61000-4-2)
Mounting	Panel mounting
Degree of Protection	IP65 (operator), NEMA Type 13
Dimensions	147W × 76H × 39.3D mm
Weight (approx.)	280g

Operation Specifications

Switching Element	Analog resistive membrane
Operating Force	0.2 to 0.8N
Mechanical Life	1,000,000 operations
Acknowledge Sound	Electronic buzzer

Function Specifications

Screen Types	Base screen, popup screen, system screen
No. of Screens	Base screen: 3000 max., popup screen: 3000 max.
User Memory	1 MB (including expansion fonts)
Parts	Bit Button, Word Button, Goto Screen Button, Print Button, Key Button Keypad, Selector Switch, Potentiometer, Numerical Input, Character Input, Pilot Lamp, Multi-State Lamp, Picture Display, Message Display, Message Switching Display, Alarm List Display, Alarm Log Display, Numerical Display, Bar Graph, Trend Chart, Pie Chart, Meter, Calendar, Bit Write Command, Word Write Command, Goto Screen Command, Print Command, Screen Script Command, Timer
Calendar	Year, Month, Day, Hour, Min., Sec., Day of Week ±30 sec per month (at 25°C)
Power Failure Backup Data	Calendar, log data, keep internal relay, keep internal register
Battery Life	4 years (at 25°C)

Display Specifications

LCD	Monochrome STN	
Effective Display Area	111W × 37H mm	
Display Resolution	300W × 100H pixels	
LCD Life	50,000 hours minimum	
Contrast Adjustment	Possible in steps using the front touch screen	
Backlight	Cold-cathode tube	
Backlight Life	50,000 hours nominal (Note)	
Backlight Control	Automatic OFF	
Backlight Replacement	Possible	
Display Character Size	1/4 size	8 × 8 pixels (Western European language: ISO 8859-1, Central European language: ANSI 1250, Baltic: ANSI1257, Cyrillic: ANSI1251, Japanese katakana and symbols: JIS 8-bit code)
	1/2 size	8 × 16 pixels (Western European language ISO 8859-1, Central European language: ANSI 1250, Baltic: ANSI1257, Cyrillic: ANSI1251, Japanese katakana and symbols: JIS 8-bit code) 16 × 32 pixels, 24 × 48 pixels, 32 × 64 pixels (Western European language: ISO 8859-1)
	Full size	16 × 16 pixels (Japanese JIS first and second level characters, simplified Chinese, traditional Chinese, Korean)
	Double size	32 × 32 pixels (Japanese JIS first level characters, Mincho font)
Quantity of Characters	1/4 size	37 characters × 12 lines
	1/2 size	37 characters × 6 lines
	Full size	18 characters × 6 lines
	Double size	9 characters × 3 lines
Character Magnification	0.5, 1, 2, 3, 4, and 8 vertically and horizontally	
Character Attribute	Blink (1 or 0.5 sec period), reverse, bold, shadowed	
Graphics Type	Straight line, polyline, rectangle, circle, ellipse, arc, pie, equilateral polygons (3, 4, 5, 6, 8), paint, bitmap image	
Window Display	3 popup screens + 1 system screen	

Note: The backlight life refers to the time until the surface brightness reduces to a half after using continuously at room temperatures.

Interface Specifications

RS232C	Electrical Characteristics	EIA RS232C compliant
	Transmission Speed	1200, 2400, 4800, 9600, 19200, 38400, 57600, 115200 bps
	Synchronization	Asynchronous
	Communication Method	Half or full duplex
	Control System	Hardware control or none
RS485/RS422	Electrical Characteristics	EIA RS485/RS422 compliant
	Transmission Speed	1200, 2400, 4800, 9600, 19200, 38400, 57600, 115200 bps
	Synchronization	Asynchronous
	Communication Method	Half or full duplex
	Control System	Hardware control or none
Maintenance Communication	Connector	RS485: D-sub 9-pin female connector RS422: 5-pole terminal block
	Electrical Characteristics	EIA RS232C compliant
	Transmission Speed	9600, 19200, 38400, 57600, 115200 bps
	Synchronization	Asynchronous
	Communication Method	Half duplex, proprietary protocol
OI Link Communication	Connector	Mini DIN 8-pin connector
	Electrical Characteristics	EIA RS485 compliant
	Transmission Speed	19200, 38400, 57600, 115200 bps
	Synchronization	Asynchronous
	Communication Method	Half duplex, proprietary protocol
Connector	Special connector	



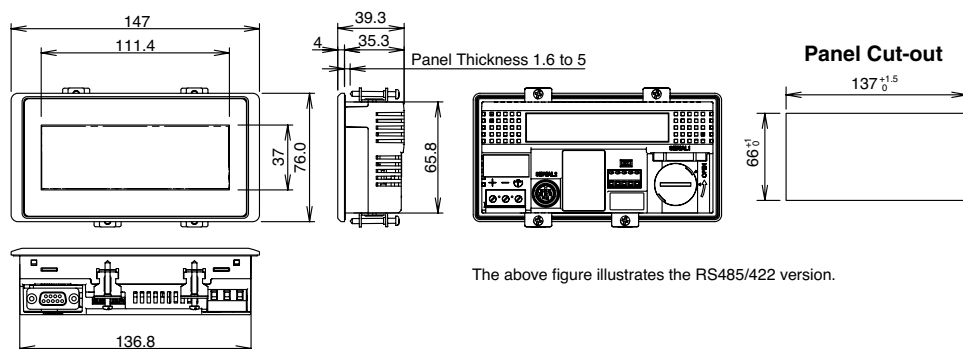



Dimensions



The above figure illustrates the RS485/422 version.

All dimensions in mm.

HG Series Operator Interfaces, CC Pendant, and Small Teaching Pendant

Model	Large		Medium		CC Pendant		Small Teaching Pendant
Type	HG4F	HG3F	HG2F (Color)	HG2F (Monochrome)	HG2S (Color)	HG2S (Monochrome)	HG1T
Screen Size	12.1 inches	10.4 inches	5.7 inches	5.7 inches	5.7 inches	5.7 inches	4 inches
Appearance							
LCD	TFT	TFT	STN	STN	STN	STN	STN
Pixels	800 x 600	640 x 480	320 x 240	320 x 240	320 x 240	320 x 240	192 x 64
Display Color	256 colors	256 colors	256 colors	Monochrome	256 colors	Monochrome	Monochrome
User Memory Size	6 MB	6 MB	2 MB	2 MB	2 MB	2 MB	512 KB
Memory Card (CF)	Yes	Yes	Yes	Yes	—	—	—
Ethernet Port	Yes	Yes	—	—	—	—	—
O/I Link	Yes	Yes	Yes	Yes	Yes	Yes	—
USB	—	—	Yes	Yes	—	—	—
RS232C	Yes	Yes	Yes	Yes	Yes	Yes	Yes
RS485/422	Yes	Yes	Yes	Yes	Yes	Yes	Yes
UL	Yes	Yes	Yes	Yes	Yes	Yes	Yes
CSA (c-UL)	Yes	Yes	Yes	Yes	Yes	Yes	Yes
CE	Yes	Yes	Yes	Yes	Yes	Yes	Yes
Design Tool	WindO/I-NV2						WindE/T

For details about HG series operator interface and CC pendant, see separate catalog (EP1057).

MICROSmart pentra FC5A / MICROSmart FC4A Programmable Controllers

High-performance micro programmable logic controllers meet a wide range of applications. FC5A features an IDEC Logic Engine to achieve the fastest processing of its kind.



WindLDR



For details, see the MicroSmart FC5A/FC4A catalog (EP1101).

• CPU Module FC5A

Type	Type No.	I/O Points
Slim (DC Power)	FC5A-D16RK1	8 in / 8 out
	FC5A-D16RS1	
	FC5A-D32K3	16 in / 16 out
	FC5A-D32S3	
All-in-One (AC Power)	FC5A-C10R2	6 in / 4 out
	FC5A-C16R2	9 in / 7 out
	FC5A-C24R2	14 in / 10 out
All-in-One (DC Power)	FC5A-C10R2C	6 in / 4 out
	FC5A-C16R2C	9 in / 7 out
	FC5A-C24R2C	14 in / 10 out

• CPU Module FC4A

Type	Type No.	I/O Points
Slim (DC Power)	FC4A-D20K3	12 in / 8 out
	FC4A-D20S3	
	FC4A-D20RK1	
	FC4A-D20RS1	24 in / 16 out
	FC4A-D40K3	
	FC4A-D40S3	
All-in-One (AC Power)	FC4A-C10R2	6 in / 4 out
	FC4A-C16R2	9 in / 7 out
	FC4A-C24R2	14 in / 10 out
All-in-One (DC Power)	FC4A-C10R2C	6 in / 4 out
	FC4A-C16R2C	9 in / 7 out
	FC4A-C24R2C	14 in / 10 out

• I/O Modules

Module	I/O Points	Models
Input	8 in	2
	16 in	2
	32 in	1
Output	8 out	3
	16 out	3
	32 out	2
I/O	4 in / 4 out	1
	16 in / 8 out	1
	2 in / 1 out	2
Analog	2 in	1
	1 out	1

Specifications and other descriptions in this catalog are subject to change without notice.



IDEC CORPORATION

7-31, Nishi-Miyahara 1-Chome, Yodogawa-ku, Osaka 532-8550, Japan
Tel: +81-6-6398-2571, Fax: +81-6-6392-9731
E-mail: products@idec.co.jp

IDEC CORPORATION (USA)
1175 Elko Drive, Sunnyvale, CA 94089-2209, USA
Tel: +1-408-747-0550 / (800) 262-IDEC (4332)
Fax: +1-408-744-9055 / (800) 635-6246
E-mail: opencontact@idec.com

IDEC CANADA LIMITED
Unit 22-151, Brunel Road, Mississauga, Ontario, L4Z 1X3, Canada
Tel: +1-905-890-8561, Toll Free: (888) 317-4332
Fax: +1-905-890-8562
E-mail: sales@ca.idec.com

IDEC AUSTRALIA PTY. LTD.
2/3 Macro Court, Rowville, Victoria 3178, Australia
Tel: +61-3-9763-3244, Toll Free: 1800-68-4332
Fax: +61-3-9763-3255
E-mail: sales@au.idec.com

IDEC ELECTRONICS LIMITED
Unit 2, Beechwood, Chineham Business Park, Basingstoke, Hampshire RG24 8WA, UK
Tel: +44-1256-321000, Fax: +44-1256-327755
E-mail: sales@uk.idec.com

IDEC ELEKTROTECHNIK GmbH
Wendenstrasse 331, 20537 Hamburg, Germany
Tel: +49-40-25 30 54 - 0, Fax: +49-40-25 30 54 - 24
E-mail: service@idec.de

IDEC (SHANGHAI) CORPORATION
Room 608-609, 6F, Gangtai Plaza, No. 700, Yan'an East Road, Shanghai 200001, P.R.C.
Tel: +86-21-5353-1000, Fax: +86-21-5353-1263
E-mail: idec@cn.idec.com

IDEC (SHANGHAI) CORPORATION
Beijing Office
Unit 1002, No. 10 Kuntai Building, Zhaowai Dajie, Zhao Yang District, Beijing, 100020, P.R.C.
Tel: +86-10-6599-5541, Fax: +86-10-6599-5540

IDEC (SHENZHEN) CORPORATION
Unit AB-3B2, Tian Xiang Building, Tian'an Cyber Park, Fu Tian District, Shenzhen, Guang Dong 518040, P.R.C.
Tel: +86-755-8356-2977, Fax: +86-755-8356-2944

IDEC IZUMI (H.K.) CO., LTD.
Unit 1505-07, DCH Commercial Centre No. 25, Westlands Road, Quarry Bay, Hong Kong
Tel: +852-2803-8989, Fax: +852-2565-0171
E-mail: info@hk.idec.com

IDEC TAIWAN CORPORATION
8F-1, No. 79, Hsin Tai Wu Road, Sec. 1, Hsi-Chih, Taipei County, Taiwan
Tel: +886-2-2698-3929, Fax: +886-2-2698-3931
E-mail: service@idec.com.tw

IDEC IZUMI ASIA PTE. LTD.
No. 31, Tannery Lane #05-01, Dragon Land Building, Singapore 347788
Tel: +65-6746-1155, Fax: +65-6844-5995
E-mail: info@sg.idec.com

www.idec.com