

# RATIOPLANT®

SINGLE IMPLANTS

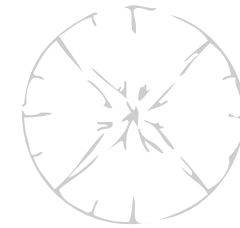

THE SIMPLE WAY TO CARE

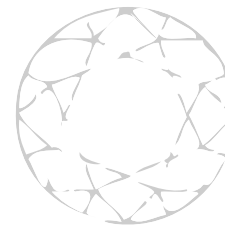

## Content

Introduction	03
RatioPlant® Single	04
Overview / Implant Sizes	05
Example Surgical Steps	06 - 07
Drills / Tools	08 - 09
Prosthetic Components / Packaging	10
Signs and Symbols, Advice	11
Contact	12

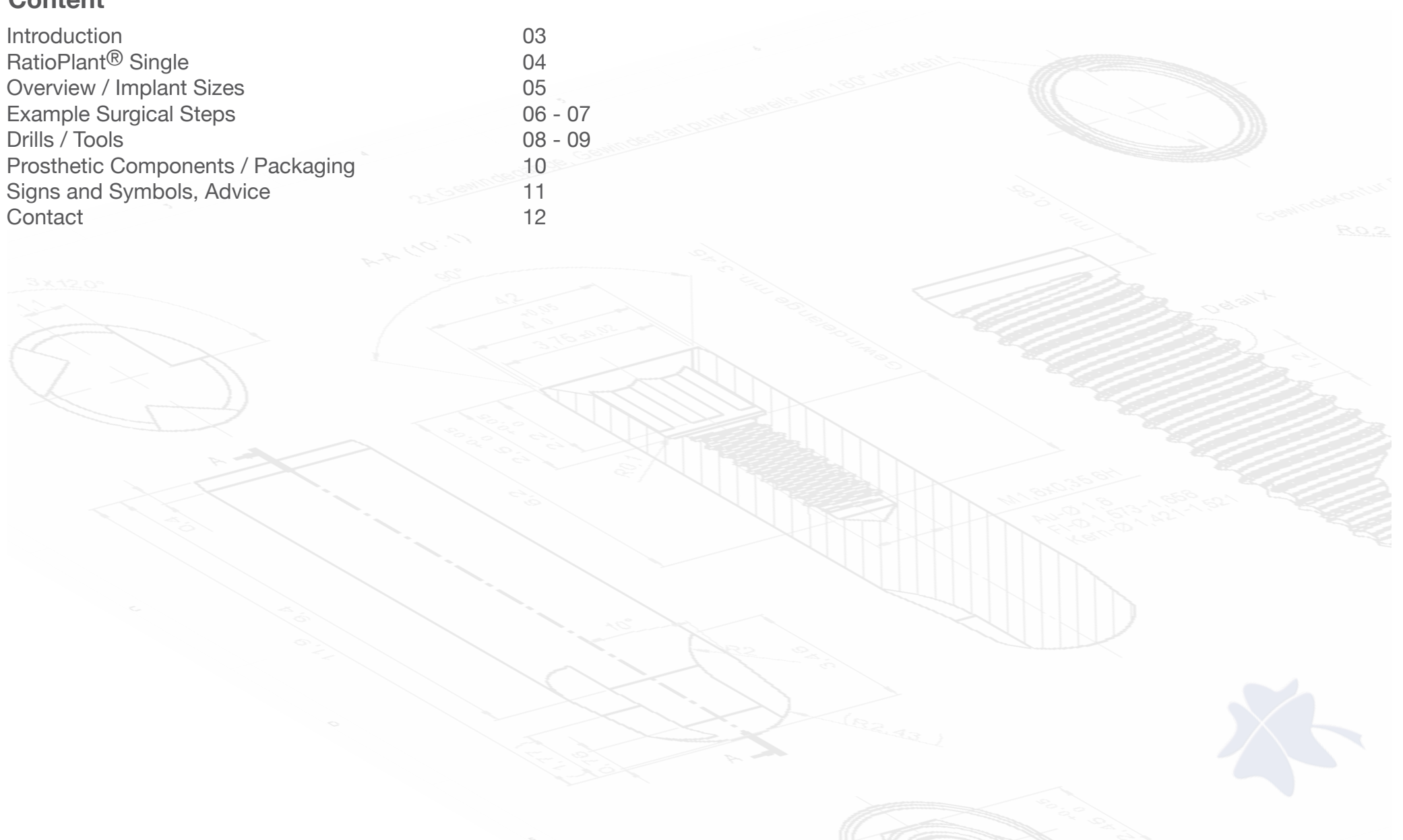



## Introduction

Our long years of experience in the field of human implantology and our expertise in the development, manufacture and testing of implants and instrument combinations provide the ultimate guarantee of extreme functionality throughout the entire HumanTech product portfolio. Given the growing need to increase the quality of human life and the dynamic market changes marked by rising pressure on costs and profit margins, factors such as cost-oriented manufacture and distribution are increasingly occupying centre stage.

HumanTech is a company group dedicated one hundred percent to the development, deployment and manufacture of implants and instruments in the medical field, and to the on-going search for ever better solutions.

We eliminate unnecessary distribution costs by cutting out the middle man: Customers buy HumanTech products direct from us, the manufacturer:

From development through to the finished product and customer service – all from a single, reliable source.

The RatioPlant® implants are manufactured, packed after the up to date guidelines in our house and brought directly to our customers to the dispatch.

The variety of the RatioPlant® implant lines offers a broad range of clinical solutions, up to reconstructions of single crowns, sew connected or fixed cemented bridges and partial or full dentures. Furthermore you can use RatioPlant® of implants in all situations, from the simplest to the most difficult, surgical and bone augmentation procedures. They are manufactured from biocompatible quality titanium and by their blasted and etched surfaces on the state of the art. All RatioPlant® implants fulfill the highest international standards.

We are certified according to DIN EN ISO 13485/46001 as well as appendix II of the guideline 93/42 EEC.

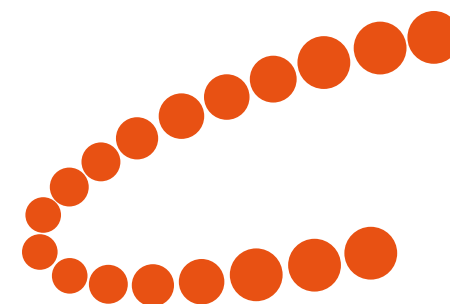

# RatioPlant® Single

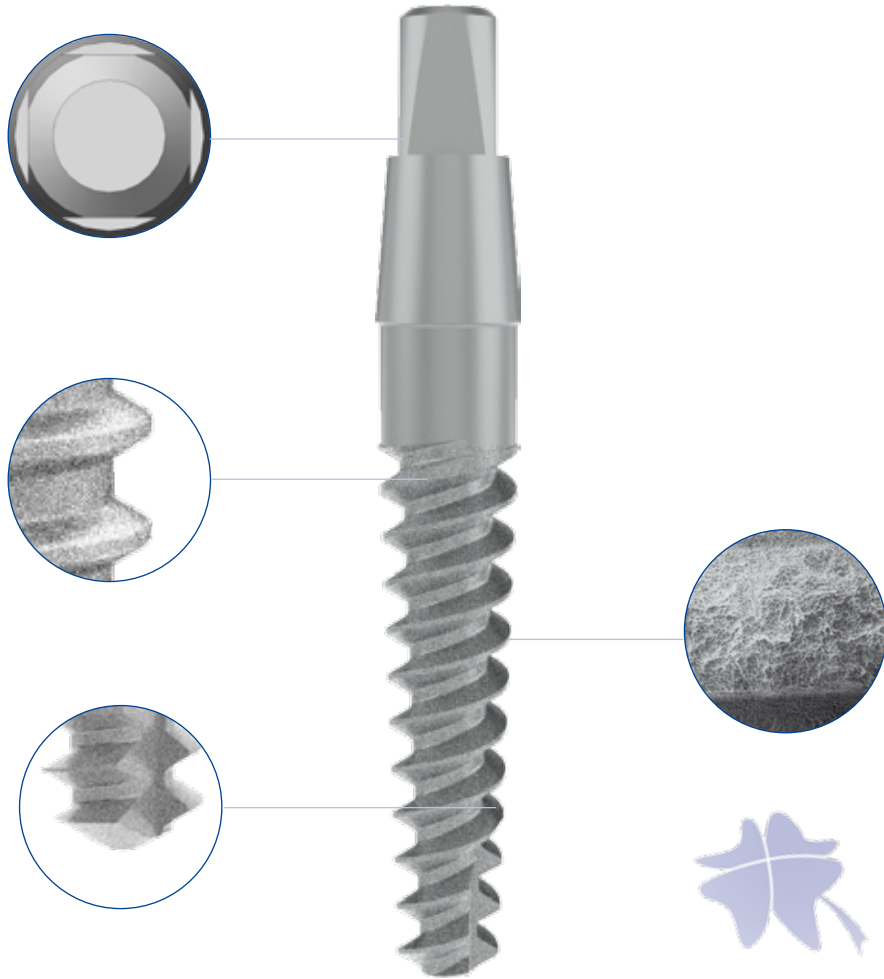









## Features

- The implants of the RatioPlant® Single line are one-piece screw implants with sandblasted and etched surface for all indications.
- The implants have a fixed and conical connection with a square connection for insertion and anti-twist safeguard to embed single crowns, telescopic secondary parts or other prosthetic components.
- Made of Ti6Al4V - ISO 5832-3.
- The Single line features over a atraumatic cutting thread with three cutting slots to the bone chip admission and rotation protection as well.
- For an ideal indication with consideration of stability the RatioPlant® Single implants are available with two different diameters and four lengths.

## Advantages

- Simple application with only one tool and three drills for all Single implants.
- Anatomical root analogous design for outstanding results at difficult space conditions (mandibula front area).
- Outstanding a healing with optimum apposition of the osteoblasts to the special nano-surface.
- No static connectivity problems between implant and abutment under load by design in one piece.
- Direct loading after insertion possible.

## Implant Sizes

L / Ø	3.0	3.5
10.0		
11.5		
13.0		
16.0		

Two sizes - One abutment structure

- Implant diameter 3.0 - all lengths
- Implant diameter 3.5 - all lengths

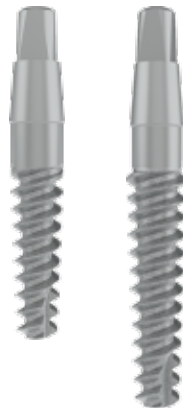

## Surigical Drills

For the Single-implant offers HumanTech Germany GmbH a small set with only three drills to realize a safe, simple and quick implantation procedure.

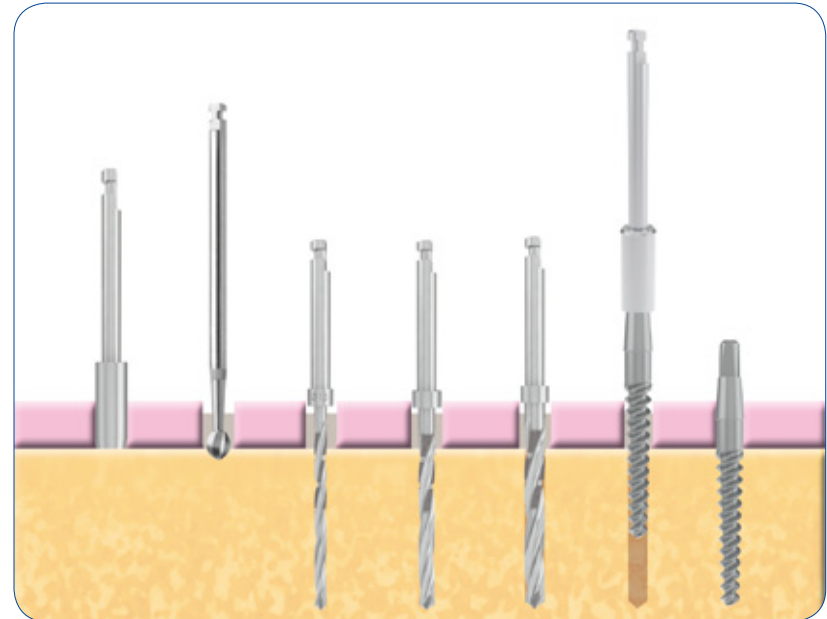

## Tools

To insert the RatioPlant®Single-implants only one type tool is necessary, that is available in two lengths, one for motor handpiece and one ratchet.



## Surgical steps - example

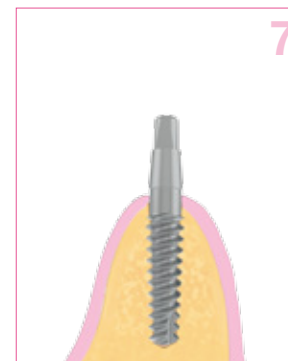
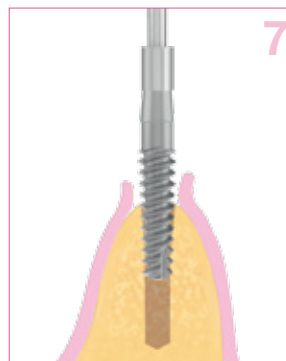
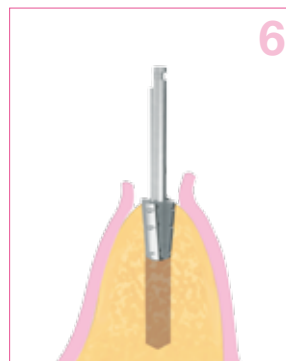
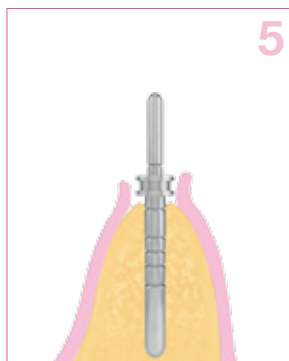
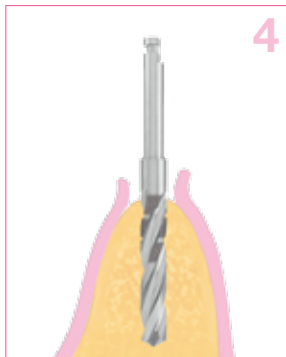
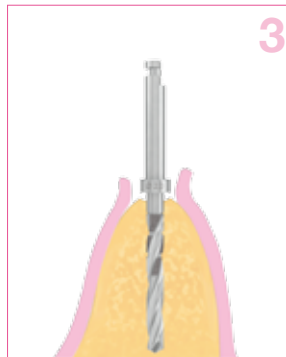
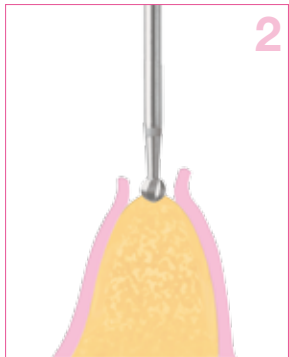
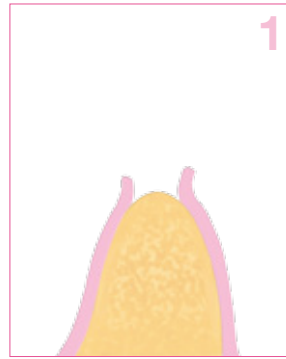
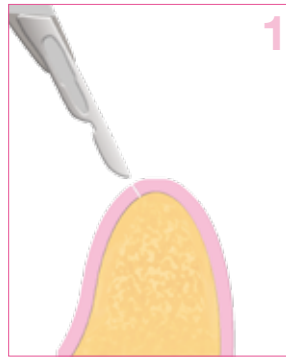
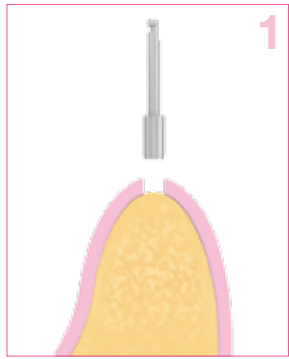

### Surgical Phase - using the example of RatioPlant® Single 3.5 / 13.0

1. Exposure of the bone using Scalpel or Gingiva cutter
2. Punch-marking - define implant position
3. Pilot drilling
4. Extension drilling to necessary diameter and final drilling
5. Depth measurement (optional)
6. Countersink
7. Setting of the implant using adapter for motor, subsequently tighten using torque ratchet and adapter for ratchet with max. 40 Ncm





### Prosthetic Care

8. Place transfer cap, proceed impression (closed impression)
9. Quick-abutment Plastic or Titanium Single for removable dentures
10. Application for hybrid prosthesis
11. Quick-abutment Gold Single hex for crowns and bridges
12. Customized abutment design
13. Crown design with porcelain

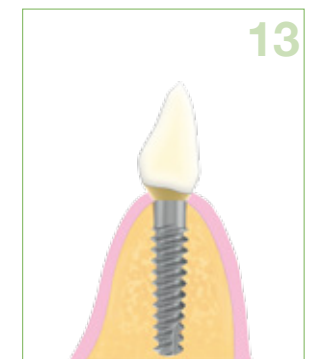
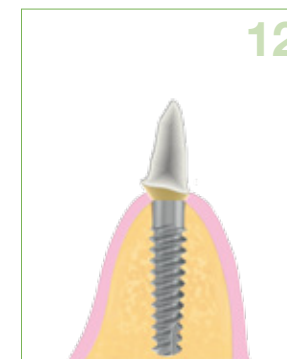
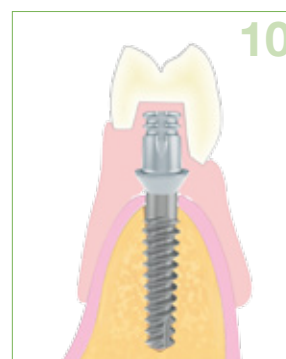
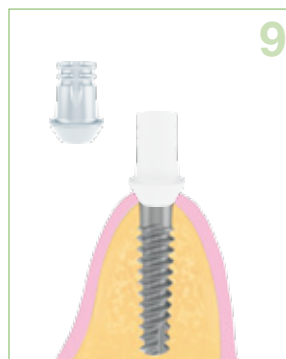
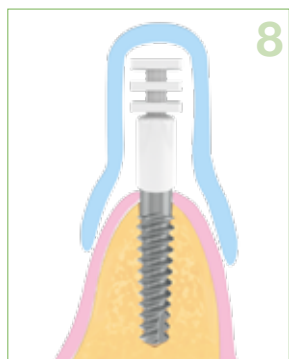

### Advice



The following descriptions are not sufficient for the immediate application of the RatioPlant® Implant System. We recommend the briefing into the handling of the RatioPlant® Implant System by an experienced surgeon. Fundamentally the RatioPlant® Implant System only should be used by trained dentists, implantologists and dental technicians.

Methodological errors can lead to the loss and damage to the peri-implant bone. Processing and application of the products are beyond our control and are under the responsibility of each user. Any liability for damage which caused in this case is excluded.

Please also see our information on safety, liability and warranty on page 11.

## Tools and Drills

rosehead bur 2.3 - 3.5mm	5010323340 5010335340	
Pilot drill 1.5 mm	5010315340	
twist drill 2.8 mm	5010328374	
twist drill 3.0 mm	5010330376	
insert square hand short	5012302011	
insert square hand long	5012302012	
insert square motor short	5012302015	
insert square motor long	5012302016	
insert square ratchet short	5012302013	
insert square ratchet long	5012302014	

ratchet torque	5012303002	
ISO insert for ratchet/drill	5012303003	
square insert for ratchet	5012303004	

## Safety and Liability

- During use of hard materials like bone and tooth substance can cause the premature loss of the cutting edges. Therefore, the drills must be checked after each use for blunt cut or damages and replaced as necessary.
- To avoid instrument fracture, the specified speed is observed.
- Caution: Risk of injury by the sharp edges of the drill! Risk of injury from twisting and slipping of the drill! The user is obliged to inspect the product to accept responsibility for its use before the suitability and the possible uses for the intended purposes. The use of the drill is the responsibility of the user.
- Guideline for the frequency use > 10 - 20 x (assuming no wear is evident, even prolonged use is possible).



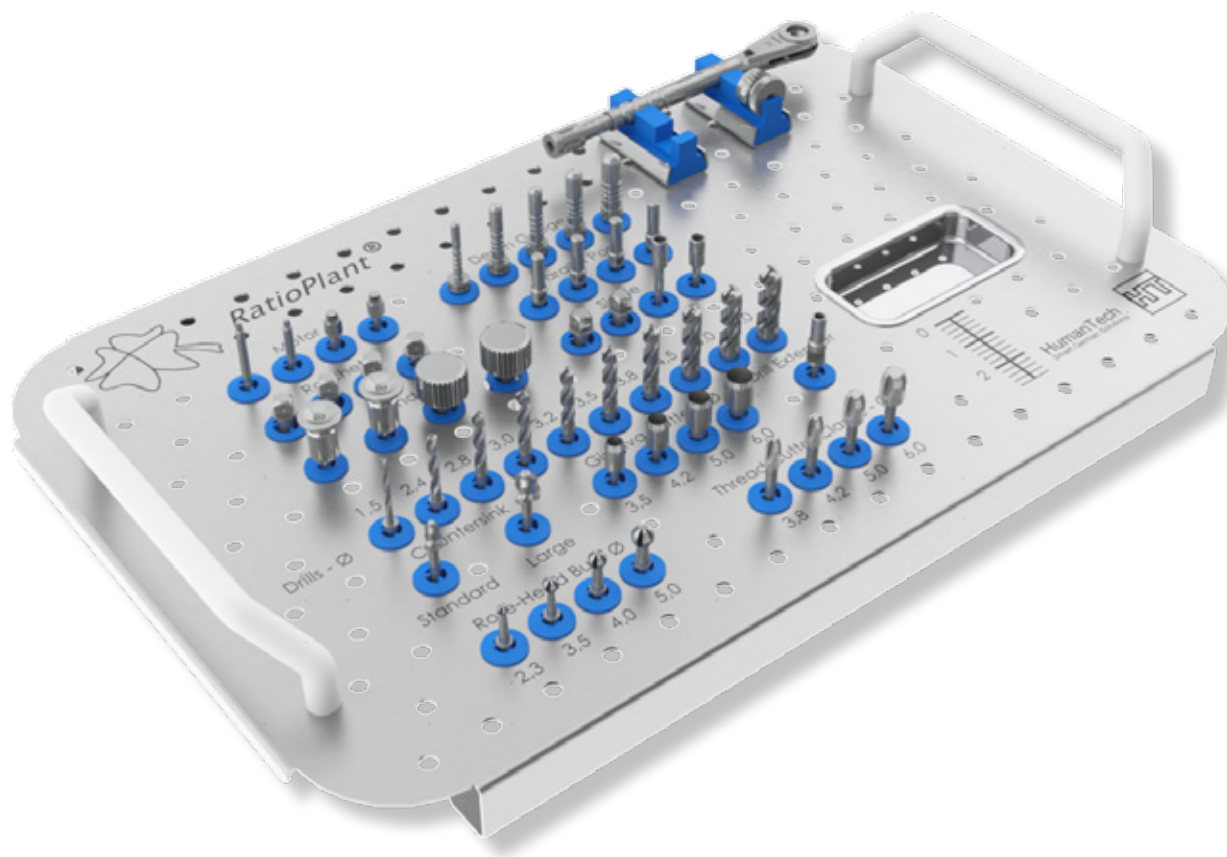

## Care instructions for tools and drill bits

The drills are supplied nonsterile. Therefore, all drill before the first application has to be cleaned, disinfected and sterilized. Deposit the drill bits immediately after each surgery in disinfectant solution. Take care that the surgery residues (blood, secretions, tissue residues) will not dry. The drills have to be disinfected with disinfectants and cleaning agents for rotary instruments.

The use of information (exposure time, concentration, aptitude) of disinfectants and cleaning materials are provided by the manufacturers. For the pre-cleaning brushes should only be used with metal-free bristles, because these do not generate any abrasion causing discoloration of the instrument. The cleaning and disinfection may not occur in a thermal disinfection, because it can attack the surface by the interaction of high temperature and cleaning agent the instruments.

Rinse the disinfectant and detergent thoroughly with water and dry carefully the instruments (e.g., using airflow). Never leave or store the instruments moist or wet for a long time. When cleaning in the ultrasonic cleaner the instruments should not have any contact!

Inspection of the cleaned instruments visually. Eliminate damaged or blunt instruments.

The same applies to instruments that were stressed spontaneously (e.g. by being dropped down on the floor, etc.). Do not use these instruments anymore because an increased risk of breakage is given! Sterilization is performed in an autoclave (134 °C/273 °F) by the established methods. The equipment manufacturer's advices are observed.

Check instruments after sterilization for surface attacks (cracking).

## Prosthetic Components













transfer cap Single	5011205051	
lab analog Single	5011110003	
quick-abutment Gold Single hex, cast-on technique	5011510051	
quick-abutment Ti Single	5011110051	
quick-abutment plastic Single hex	5011210052	
quick-abutment plastic Single	5011210051	

## Packaging

- All RatioPlant®-Implants are available in a new tube packaging, which is packed in a separate blister - user-friendly, safe and double sterile.
- This package provided an easy take out with the adapter directly from the tube during surgery.
- Patients labels with all relevant data enable an easy documentation of the used implants.



## Signs and Symbols according DIN EN 980:2008-08

	Manufacturer
	Manufacturing date
	Date of expiry
	Reference number
	Lot number
	Sterilization using irradiation
	Do not reuse
	Do not use with damaged packing
	Store in a dry place
	Do not resterilize
	Attention, see instruction for use
	Attention

## Safety, liability and warranty

### Safety

The RatioPlant®-implant system may be used only under the guidance and recommendation of the HumanTech Germany GmbH.

The use of components which are not corresponding original components to the system will impede the functionality and exclude our liability. Guidance on the use of products made verbal and in demonstration events. It corresponds to the current state of knowledge at the time of distributing our products. This does not absolve the user from his obligation to the individual product in each case before the proposed use on its suitability for the intended purpose to verify. The processing and application of the products is up to the responsibility of each user. The liability for damage resulting from the use and application of the product is excluded.

As part of our general business conditions we confirm the product quality of our products with CE certification, according to the current state of science and technology.

### Dispensing

The products are delivered only to dentists, doctors, surgeons, dental technicians, dental clinics and dental laboratories.

### Replacement

The withdrawal of the products can only be done in the course of an exchange. Condition for redemption of goods:

1. Two years before the end of sterility
2. Undamaged, optically modified and original packed.

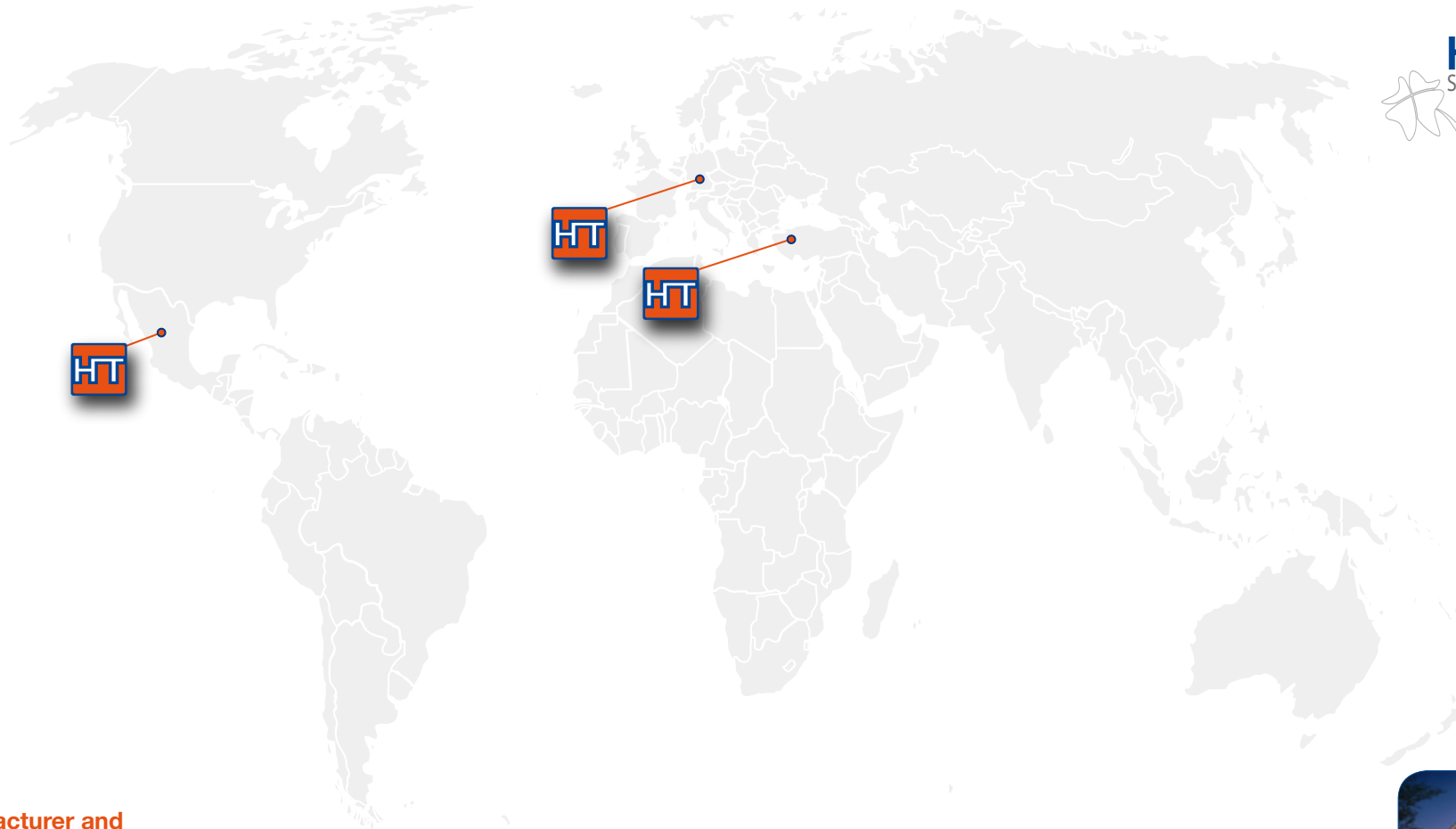

### Manufacturer and Sales Europe

HumanTech Germany GmbH

Gewerbestr. 5  
D-71144 Steinenbronn

Germany

Phone: +49 (0) 7157/5246-71  
Fax: +49 (0) 7157/5246-33  
info@humantech-solutions.de  
www.humantech-solutions.de

### Sales Middle East

HumanTech Med. Sag. Tic. Ltd.

İkitelli OSB Tümsan 2. Kısım  
C-Blok No: 47  
TR-34306 Başakşehir İstanbul

Turkey

Phone: +90 (0) 212/485 6675  
Fax: +90 (0) 212/485 6674  
info@humantech.com.tr  
www.humantech-solutions.de

### Sales Latin America

HumanTech Mexico, S. DE R.L. DE C.V.

Rio Mixcoac No. 212-3  
Acacias del Valle  
Del. Benito Juárez  
C.P. 03240 Mexico, D.F.  
Mexico

Phone: +52 (0) 55/5534 5645  
Fax: +52 (0) 55/5534 4929  
info@humantech-solutions.mx  
www.humantech-solutions.de

### Other Countries

HumanTech Germany GmbH

Gewerbestr. 5  
D-71144 Steinenbronn

Germany

Phone: +49 (0) 7157/5246-71  
Fax: +49 (0) 7157/5246-33  
info@humantech-solutions.de  
www.humantech-solutions.de

