

Harmonics

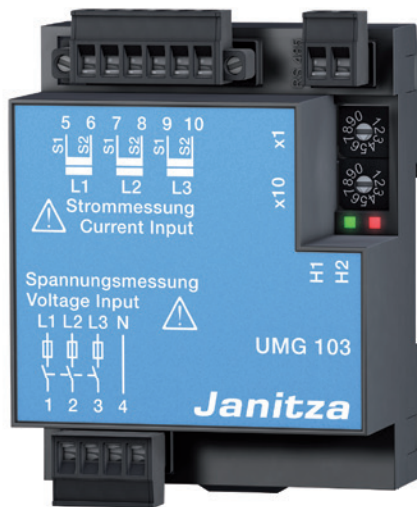

Modbus interface



GridVis®
Analysis software



Measurement accuracy 0.5



UMG 103 – Universal measurement device for DIN rails

Communication

- Protocols: Modbus RTU / Slave

Interface

- RS485

Accuracy of measurement

- Energy: Class 0.5S (... / 5 A)
- Current: 0.5 %
- Voltage: 0.2 %

Power quality

- Harmonics up to 25th order, odd harmonics
- Unbalance
- Distortion factor THD-U
- Distortion factor THD-I

Networks

- TN, TT networks

Network visualisation software

- GridVis®-Basic (in the scope of supply)

Areas of application



- Measurement and checking of electrical characteristics and energy consumption in energy distribution systems
- Cost centre management
- Threshold value monitoring, measured value transducer for building management systems or PLC
- Monitoring of harmonics



Main features



Power quality

- Harmonics analysis up to 25th harmonic, odd harmonics
- Unbalance
- Distortion factor THD-U / THD-I
- Minimum and maximum values
- Measurement of positive, negative and zero sequence component

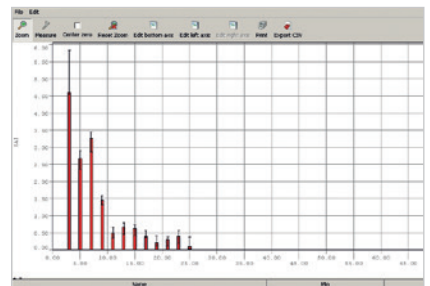

Fig.: GridVis® – Harmonics analysis (FFT)

Features

- 3 Voltage measurement inputs (300 V CATIII)
- 3 Current measurement inputs
- 3-Phase or 3 x Single-Phase-Measurement possible
- Continuous sampling of voltage and current measurement inputs
- Measurement of the reactive distortion power
- Sampling frequency 5.4 kHz
- Transfer of the measured values via a serial interface
- Supply voltage via measurement voltage L1-N, L2-N and L3-N

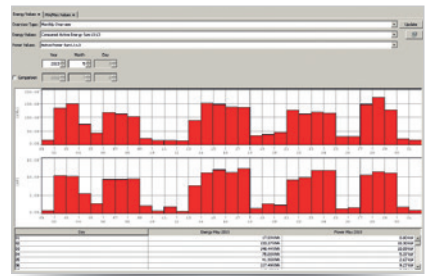
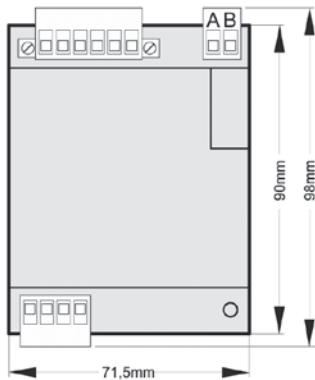

Fig.: GridVis® – Device dashboard with energy analysis



Dimension diagrams

All dimensions in mm



Front view

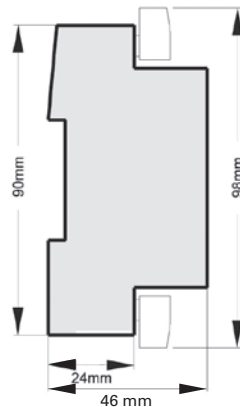

Side view



Typical connection

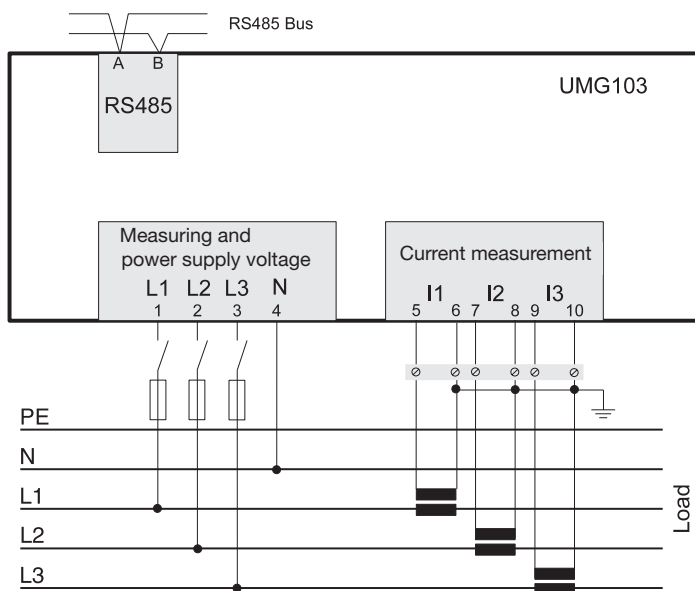

Device overview and technical data

	UMG 103
Item number	52.18.001
Item number (UL)	52.18.011 ^{*1}
Measured voltage (L-N/L-L)	240 / 415 V AC ^{*1}
Operating voltage (from 3-phase network)	80 ... 240 V AC

General	
Use in low and medium voltage networks	•
Accuracy voltage measurement	0.2 %
Accuracy current measurement	0.5 %
Accuracy active energy (kWh, .../5 A)	Class 0.5S
Number of measurement points per period	108
Uninterrupted measurement	•
RMS - momentary value	
Current, voltage, frequency	•
Active, reactive and apparent power / total and per phase	•
Power factor / total and per phase	•
Energy measurement	
Active, reactive and apparent energy [L1,L2,L3, Σ L1-L3]	•
Number of tariffs	4
Recording of the mean values	
Voltage, current / actual and maximum	•
Active, reactive and apparent power / actual and maximum	•
Frequency / actual and maximum	•
Demand calculation mode (bi-metallic function) / thermal	•

Comment:
For detailed technical information please refer to the operation manual and the Modbus address list.

• = included - = not included

^{*1} UMG 103 (UL) item number 52.18.011: Rated voltage L-N 100 ... 127 V AC; Metering range L-N 25 ... 127 V AC; Metering range L-L 44 ... 240 V AC.

Other measurements	
Operating hours measurement	•
Power quality measurements	
Harmonics per order / current	1st – 25th
Harmonics per order / voltage	1st – 25th
Distortion factor THD-U in %	•
Distortion factor THD-I in %	•
Current and voltage, positive, zero and negative sequence component	•
Measured data recording	
Online readout with GridVis®	•
Average, minimum, maximum values	•
Voltage and current inputs	each 3
Communication	
Interfaces	
RS485: Autobaud, 9.6 – 115.22 kbps (Screw-type terminal)	•
Protocols	
Modbus RTU	•
Software GridVis®-Basic*2	
Online graphs	•
Databases (Janitza DB, Derby DB); MySQL, MS SQL with higher GridVis® versions)	•
Manual reports (energy, power quality)	•
Topology views	•
Manual read-out of the measuring devices	•
Graph sets	•
Programming / threshold values / alarm management	
Comparator (2 Groups with 3 comparators each)	•
Technical data	
Type of measurement	Constant true RMS up to 25th harmonic
Nominal voltage, three-phase, 4-conductor (L-N, L-L)	240 / 415 V AC *3
Measurement in quadrants	4
Networks	TN, TT
Measured voltage input	
Overvoltage category	300 V CAT III or 150 V CAT III (UL)
Measured range, voltage L-N, AC (without potential transformer)	80 ... 240 Vrms
Measured range, voltage L-L, AC (without potential transformer)	80 ... 415 Vrms
Resolution	0.01 V
Frequency measuring range	45 ... 65 Hz
Power consumption	max. 4 VA
Sampling frequency	5.4 kHz / phase
Measured current input	
Rated current	1 / 5 A
Resolution	0.1 mA
Measurement range	0.001 ... 6 Amps
Overvoltage category	300 V CAT III
Measurement surge voltage	4 kV
Power consumption	approx. 0.2 VA (Ri = 5 MOhm)
Overload for 1 sec.	60 A (sinusoidal)
Sampling frequency	5.4 kHz / phase
Mechanical properties	
Weight	150 g
Device dimensions in mm (H x W x D)	approx. 98 x 71.5 x 46
Protection class per EN 60529	IP20
Assembly per IEC EN 60999-1 / DIN EN 50022	35-mm DIN rail
Connecting phase (U / I), Single core, multi-core, fine-stranded	0.08 to 2.5 mm ²
Terminal pins, core end sheath	1.5 mm ²
Environmental conditions	
Temperature range	Operation: K55 (-10 ... +55 °C)
Relative humidity	Operation: 5 to 95 % (at 25 °C)
Operating height	0 ... 2,000 m above sea level
Degree of pollution	2
Installation position	user-defined

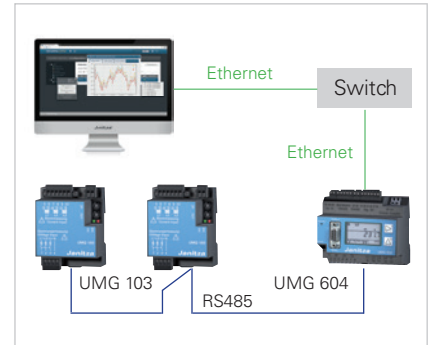

Fig.: Connection of multiple UMG 103s to a PC via a UMG 604 (with Ethernet option)

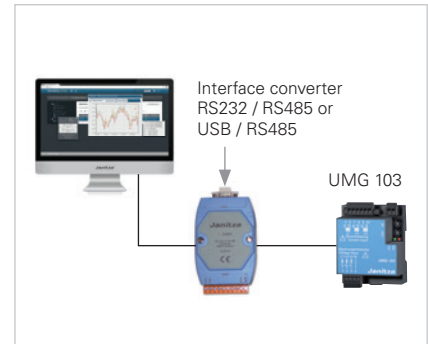

Fig.: Connection of a UMG 103 to a PC via an interface converter

*2 Optional additional functions with the packages GridVis®-Professional, GridVis®-Enterprise and GridVis®-Service.

*3 UMG 103UL Item number 52.18.011: Nominal voltage, three-phase, 4-conductor (L-N, L-L): 127 / 220 V AC

Comment: For detailed technical information please refer to the operation manual and the Modbus address list.

• = included - = not included

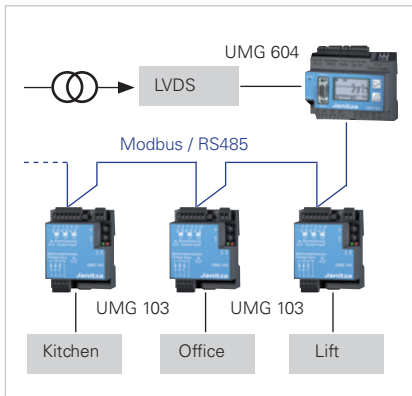

Fig.: Topology example UMG 604 (Master) – UMG 103 (Slave)

Electromagnetic compatibility	
Electromagnetic compatibility of electrical equipment	Directive 2004/108/EC
Electrical appliances for application within particular voltage limits	Directive 2006/95/EC
Equipment safety	
Safety requirements for electrical equipment for measurement, regulation, control and laboratory use – Part 1: General requirements	IEC/EN 61010-1
Part 2-030: Particular requirements for testing and measuring circuits	IEC/EN 61010-2-030
Noise immunity	
Industrial environment	IEC/EN 61326-1
Electrostatic discharge	IEC/EN 61000-4-2
Voltage dips	IEC/EN 61000-4-11
Emissions	
Class A: Residential environment	IEC/EN 61326-1
RFI Field Strength 30 – 1,000 MHz	IEC/CISPR11/EN 55011
Radiated interference voltage 0.15 – 30 MHz	IEC/CISPR11/EN 55011
Safety	
Europe	CE labelling
USA and Canada	UL variants available
Firmware	
Firmware update	Update via GridVis® software. Firmware download (free of charge) from the website: http://www.janitza.com/downloads/

Comment:
For detailed technical information please refer to the operation manual and the Modbus address list.

• = included - = not included

GridVis® software

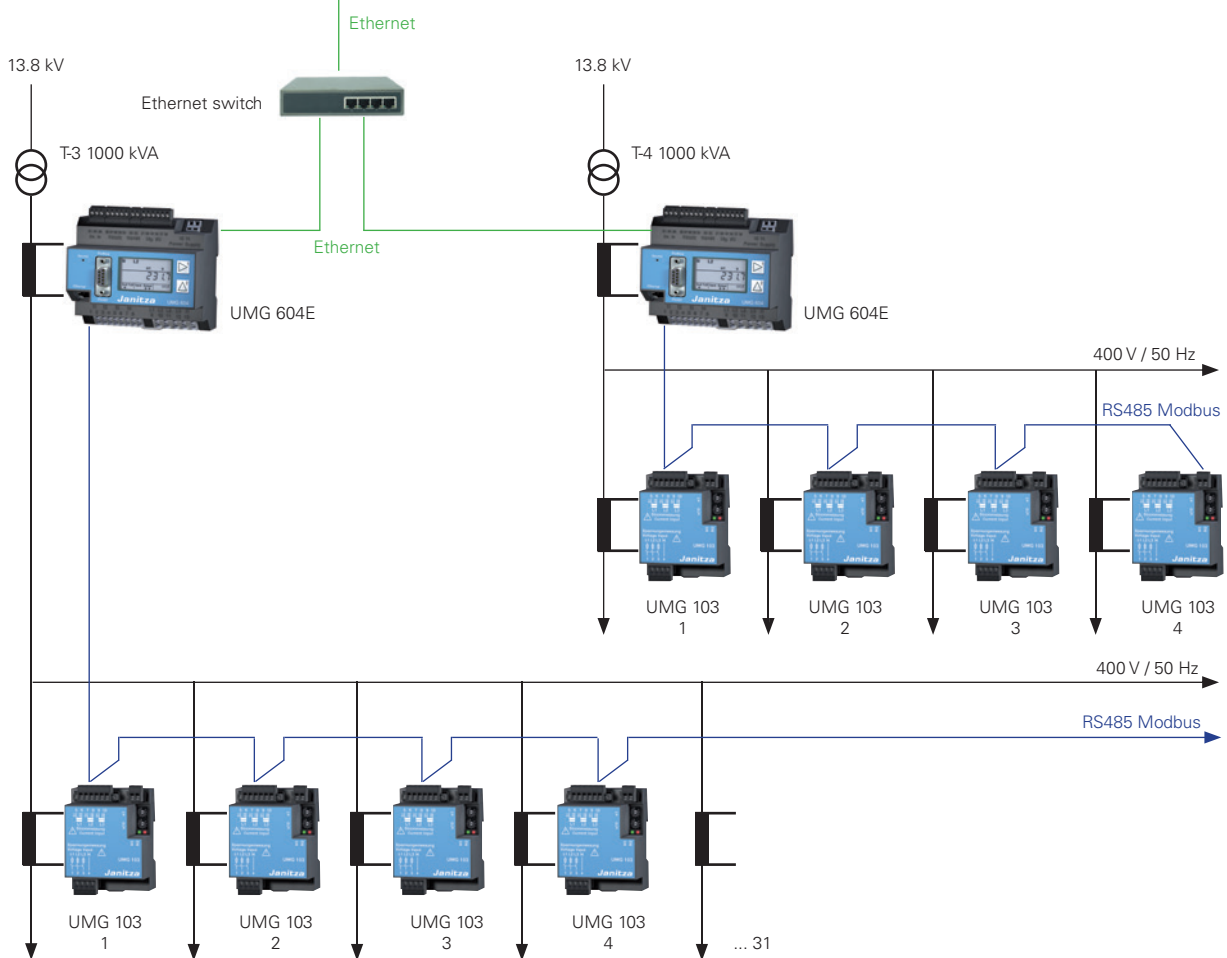

Fig.: Typical application illustration with 2 supplies, UMG 604 as master measurement device in the main power supply and UMG 103 for measuring the low voltage feeder.

Janitza electronics GmbH
Vor dem Polstück 1
D-35633 Lahnau
Germany

Tel.: +49 6441 9642-0
Fax: +49 6441 9642-30
info@janitza.de
www.janitza.com

Sales partner

Version 01/2015 • Subject to technical alterations.