

Designing with igus[®]

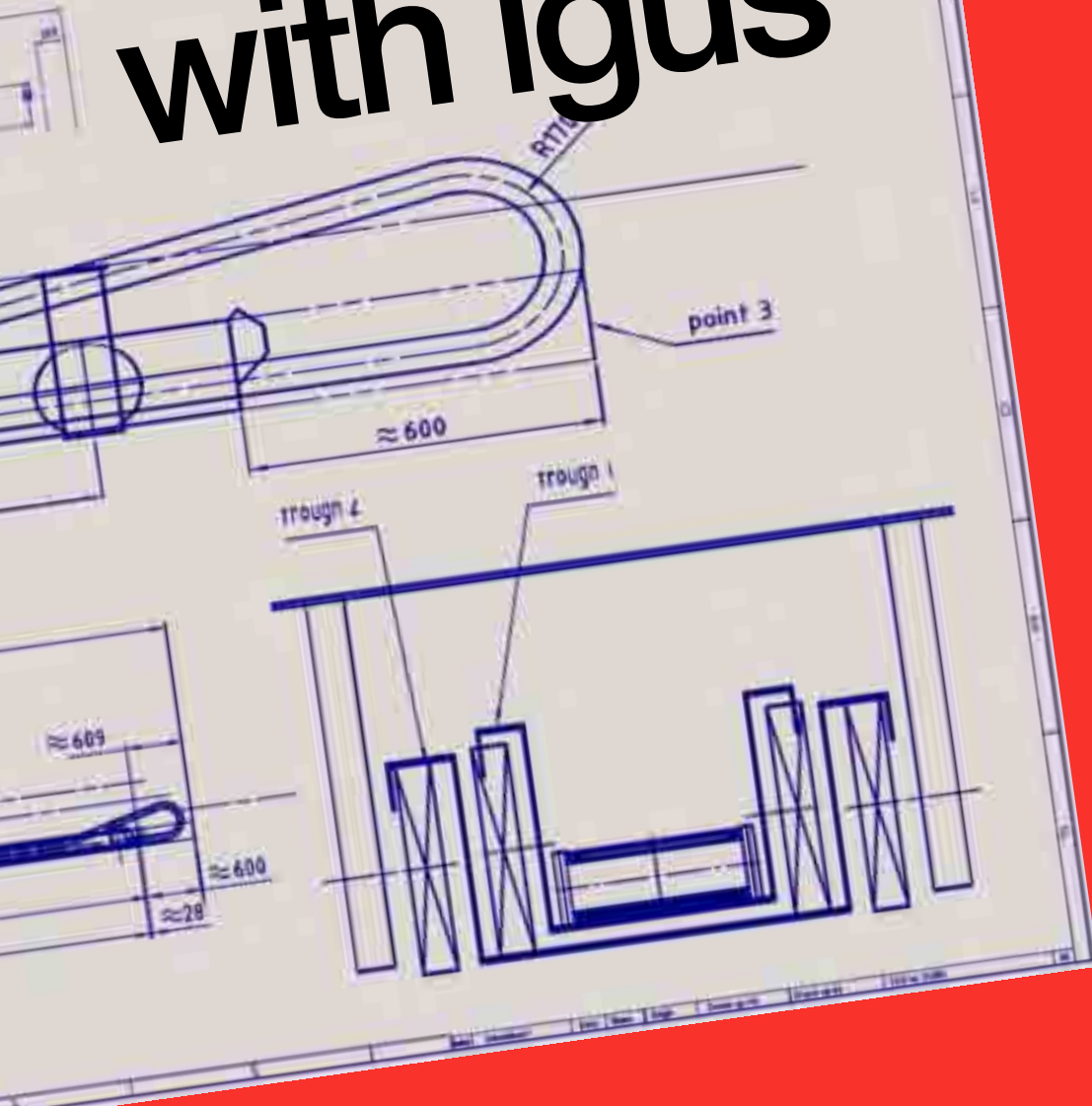

Introduction

Introduction | **Designing with igus®** page 1.3

igus® Terms | **Alphabetical Order** page 1.4

Calculation | **E-Chain®-Lengths and Camber**page 1.5

Application-Examples | **E-ChainSystems®**page 1.6

Applications

Unsupported | **Short Travels**page 1.8

Unsupported | **Noise-Optimized**page 1.11

Load Diagrams | **Unsupported Straight FL_G | Unsupported Sag FL_B** page 1.12

Gliding | **Long Travels**page 1.16

Application | **Vertical Hanging**.....page 1.20

Application | **Vertical Hanging | Zig-Zag**.....page 1.21

Application | **Vertical Standing**page 1.22

Application | **Side-Mounted**page 1.24

Application | **Rotary Motion**page 1.26

Filling and Strain Relief

Filling | **Cable and Hose Packages** page 1.28

Strain Relief Elements | **Chainfix** page 1.32

Technical Data, Standards, Material Data

Technical Environment | **Material igumid** page 1.34

Technical Environment | **ESD & ATEX** page 1.35

Technical Environment | **Clean Room and ESD** page 1.36

Technical Environment | **Dirty Environment** page 1.37

Material | **Material Data** page 1.38

Material | **Chemical Resistance and Colors** page 1.39

Certifying | **Standards and Certificates** page 1.40

ReadyChains®

ReadyChains® | **Ready-Made E-ChainSystems®** page 1.41

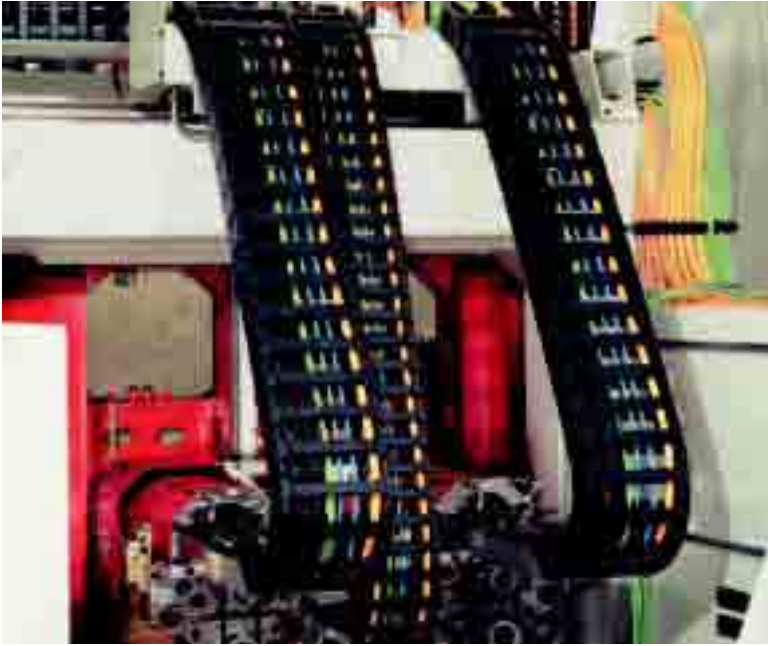

About igus® E-ChainSystems®

igus® E-ChainSystems® guide and protect moving cables and hoses on automated equipment. They can be used in a wide variety of applications and possess the following capabilities: ● **Use with various types of motion and travels** ● **Guidance of sensitive bus and data cables, as well as FOC, using the same techniques as with electric, gas, air and liquid hose guidance** ● **Long service life under very high loads and demanding requirements** ● **Smooth operation in a full range of environments and climates.** On the following pages, we offer important guidelines which are to be taken into consideration when designing safe E-ChainSystems®. All specifications are based on test results from the igus® laboratory and our field experience since 1971. Simply fill in the "igus® system design" fax sheet or log onto the igus® web site at igus.eu and e-mail us your technical specifications, or call us. **We will provide a comprehensive quote by the end of the next business day.**

Laboratory and practical experience

Our calculations and analyses are based on the result of ongoing practical tests in our Technical Center and our experience with gliding applications. The focal points of our tests are push-pull forces, friction values and abrasion under widely varying conditions and speeds, as well as factors such as dirt, weathering or impact and bumps. We test all system components such as cables, hoses, strain relief and other accessories, in addition to the E-Chains® or E-Tubes and Guide Troughs.



The igus® test laboratory for E-Chains® and Chainflex® cables

Application-Icons



Unsupported - short travels



Gliding - long travels



Vertical hanging



Vertical standing



Side-mounted



Rotary motion



Horizontal and vertical



Nested



Side by side



Combined motions

On looking through and handling of this catalog,
you will find the following terms and formula:

Short cut	Description	[°]
α	= The rotation angle of the rotating machine element	[°]
ΔM	= Deviation of the center point	[mm]
a	= Acceleration	[m/s ²]
AR	= Outer radius, E-Chain®	[mm]
Ba	= Outer E-Chain® width	[mm]
Bi	= Inner E-Chain® width	[mm]
B_{Ra}	= Guide trough outer width	[mm]
B_{Ri}	= Guide trough inner width	[mm]
D	= Over length E-Chain® radius in final position	[mm]
D_2	= Over length for long travels gliding	[mm]
FL_B	= Unsupported length with sag	[m]
FL_G	= Unsupported straight length	[m]
FL_U	= Unsupported lower run	[m]
FZ_{max}	= Maximum additional load	[kg/m]
H	= Nominal clearance height	[mm]
H_2	= Installation height with lowered mounting	[mm]
ha	= Outer E-Chain® height	[mm]
H_F	= Required clearance height	[mm]
hi	= Inner E-Chain® height	[mm]
H_{Ra}	= Outer trough height	[mm]
H_{Ri}	= Inner trough height	[mm]
IR	= Inner radius, E-Chain® (TwisterChain®)	[mm]
K	= Add-on for bending radius (K is taken from the data tables of the individual igus® Series)	[mm]
K_2	= Further add-on if the mounting bracket location is set lower (for long travels)	[mm]
L_K	= E-Chain® length	[mm]
n	= Number of links	[1]
n_{Mon}	= Number of installation sets (left/right)	[1]
n_{Ri}	= Number of trough-sets (left/right)	[1]
R	= Bending radius	[mm]
RBR	= "Reverse bending radius"	[mm]
S	= Length of travel	[mm]
$S/2$	= Half length of travel	[mm]
T	= Pitch	[mm]
v	= Speed (travel)	[m/s]
X_1	= Inner machine-construction space (TwisterChain®)	[mm]
X_2	= Outer radius chain, including clearance (TwisterChain®)	[mm]

Formula	Description
$SFL_B = 2 \cdot FL_B$	= Calculation of maximum travel length, unsupported with sag
$SFL_G = 2 \cdot FL_G$	= Calculation of maximum travel length, unsupported straight
$B_{Ri} \geq Ba + 5$	= Calculation of the minimum guide trough width
$H_{Ri} \geq 2 \cdot ha$	= Calculation of the minimum guide trough height
$K = \pi \cdot R$	= Add-on for bending radius
$L_K = S/2 + \Delta M + K$	= Calculation of chain lengths - for all types of applications, fixed end is outside the center of travel
$L_K = S/2 + K$	= Calculation of chain lengths For all types of applications, fixed end in the center of travel, except rotary movements and most long travels [m]
$L_K = S/2 + K_2$	= Calculation of chain lengths for long travels, fixed end in the center of travel [m]

Calculation of E-Chain® lengths

If the fixed end of the **E-Chain®** is located in the center of the travel, the E-Chain® length " L_K " is calculated by using half the length of travel and adding the value " K " for the curved length. (You can obtain the value " K " from the tables in the catalog.) Placing the **Fixed End** in the center of the travel is the most **cost-effective solution** because it requires the shortest E-Chain®, cables and hoses.



The fixed end in the center of the travel is the most favorable solution

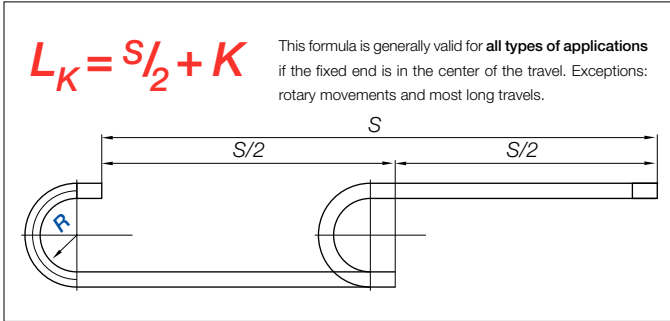

- L_K = E-Chain® length
 - S = Length of travel
 - R = Bending radius
 - ΔM = Deviation from the center point
 - $K = \pi \cdot R + \text{"safety"}$
- Add-on for bending radius (K is taken from the data tables of the individual igus® Series)
- H = Nominal clearance height
 - H_F = Required clearance height

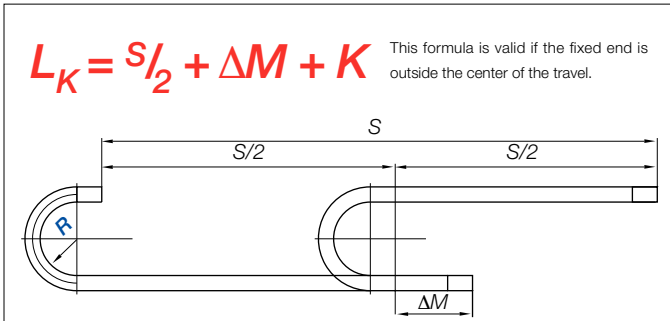

Camber

Camber is the curve of the upper run along its unsupported length. **All igus® E-Chains® are manufactured with camber, special "no camber" E-Chains® on request.** The camber allows for longer unsupported lengths and increases service life and operating safety. In the Installation Dimensions section of each respective E-Chain® description, you will find the measurement H_F , which specifies the **necessary clearance height**, taking the camber into account. Upon request, we can deliver E-Chains® without camber for restricted space applications - however, these "no camber" chains do not have the same load-bearing capacity. Please consult igus®.

"No Camber" - Special "NC" E-Chains® with no camber also available. Please consult igus®.

Necessary clearance height - depends on the camber of the E-Chain®. Find values for the necessary clearance height " H_F " on each product page.

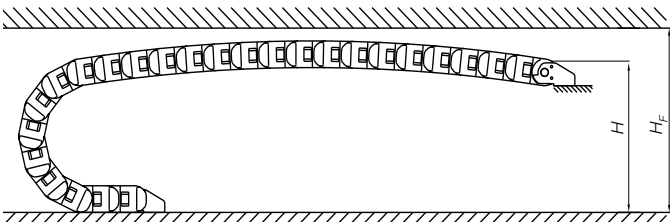

Principle of camber for igus® E-Chains® H_F = required installation height



Diagrams unsupported length ► page 1.12

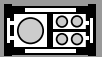
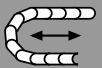

igus® E-ChainSystems®



Long travels (441 m) with Rol E-Chain®.
Long travel applications ► page 1.16



High fill weights (60 kg/m) with System E4.
Fill weights/Load diagrams ► page 1.12



Multi-axis Easy Triflex® on a production line,
combined movements ► chapter 2

Phone +49- (0) 22 03-96 49-800
Fax +49- (0) 22 03-96 49-222



ReadyChain® under water. System E4 and
Chainflex® CF9, ReadyChain® ► page 1.41



ReadyChain® with combined motions
on tooling machines ► page 1.41



Series E6.52 high speed (15 m/s) low noise
operation, optimized noise level ► page 1.11

igus® GmbH
51147 Cologne



Crash test unit: 22 m/s speed and 784 m/s²
acceleration, travel speed ► page 1.19



Complex movements with Triflex® R,
combined movements ► chapter 2



Cleanroom and Triflex® R
Technical Environment ► chapter 2

Internet: www.igus.eu
E-mail: info@igus.de



Extension links for E2 and E4 for large
conduits, cable and hoses ► page 1.28



Zig-Zag movements, 36 m height with
E4/4. Zig-Zag movements ► page 1.21



igus® System E6 - High acceleration and
ESD safety, ESD & ATEX ► page 1.35



Unsupported application System E4,
up to 50 m/s speed ► page 1.8



Unsupported, side-mounted
E4 Series R188 ► page 1.24



Unsupported application
System E4 ► chapter 7



Gliding application System E4,
up to 500 m realized ► page 1.16



Gliding, side-mounted
Series E4/4 ► page 1.24



Gliding application
System E4 ► page 1.23



Vertical, standing Series E4/light,
up to 6 m possible ► page 1.22



Rotary movement
System E4 ► page 1.26



E-Chains® side by side as individual or
"multiband" - Series Zipper ► chapter 4



Vertical, hanging Series E4 up
to 40 m possible ► page 1.20



Spiral and rotary movement
TwisterChain® ► page 1.26



Combined movement
Series Triflex® ► chapter 2

Design
Solutions

Phone +49- (0) 22 03-96 49-800

Fax +49- (0) 22 03-96 49-222

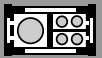
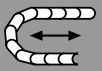



Unsupported

If the upper run of the E-Chain® operates without touching the lower run over the entire travel, it is called an "unsupported" application.

Unsupported length

The distance between moving end and the beginning of the radius curve of the E-Chain® is called the "unsupported length." It is always dependent upon the type of E-Chain® and the fill weight.



The " FL_G " type of installation always generates the longest service life and can be operated with the max. values for speed and acceleration.



Example for unsupported straight FL_G

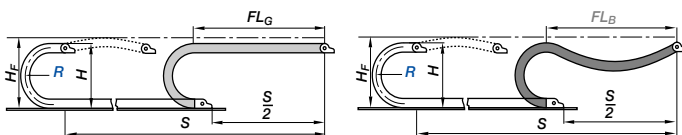

Unsupported applications

The "unsupported" application is the most common. igus® E-Chains® are very well suited for high dynamics and long service life. The maximum unsupported length is dependent upon the fill weight and the type of E-Chain® or E-Tube. As a result, we differentiate among three types of unsupported length:

01) Unsupported with straight upper run FL_G



The " FL_G " E-Chain® applies when the upper run either has camber, is straight, or has a maximum of 10-50 mm sag, depending on the size of the chain. The " FL_G " type of installation is always preferred. The E-Chain® runs quietly and is not exposed to any additional vibration.

02) Unsupported with permitted sag FL_B

The " FL_B " E-Chain® applies when the sag amounts to more than 10-50 mm, depending on the chain size, and less than a defined maximum sag. This maximum sag is dependent on the type of chain. The " FL_B " application is technically permissible in many cases. It becomes problematic if the acceleration and the travel frequency are high.

03) "Critical sag"

If the sag is greater than permissible for " FL_B ", then we refer to it as "critical sag." An installation with critical sag must be avoided or reserved for extreme circumstances. An E-Chain® should never be installed with critical sag. There are applications which, after a very long period of use, reach the stage of "critical sag." The E-Chain® or E-Tube should be replaced at that time.

Please contact us if your application reaches critical sag!

The following important factors should be considered to select the correct E-Chain®:

- Unsupported length
- Speed
- Acceleration
- Service life
- Load bearing areas
- Noise level
- Technical environment

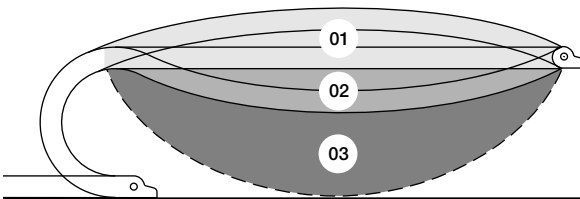



Example of unsupported permissible, FL_B

Unsupported Length

For every igus® E-Chain® or E-Tube, you will find the values for " FL_G " and " FL_B " in two locations: On the following pages in this chapter as an overview and within every individual series' chapter. These values are essential for: ● Finding a suitable E-Chain® for your fill weight and travel distance ● Identifying the maximum load for the selected E-Chain®. **Diagrams unsupported length ▶ from page 1.12**

What to do if the unsupported length is insufficient

If your application, fill weight and travel fall outside the "unsupported length" parameters of the desired E-Chain®, you have the following options:

- Select a more stable igus® E-Chain®
- Support the E-Chain® in the unsupported area (this possibility has restrictions for acceleration, speed and noise as a consequence - three fundamental examples are detailed to below - please consult igus® if you are considering this possibility - we will gladly provide you with a detailed proposal)
- Use a "multiband" chain or "nest" two E-Chains® inside one another (please consult igus® regarding these options)
- Design the travel distance as a "gliding application".



Series 28 with support of the " FL_B " area

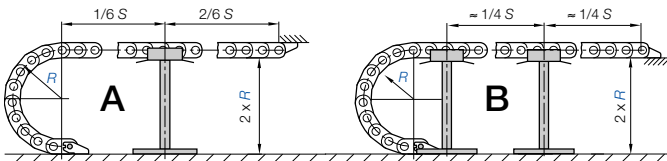

Support of the " FL_G " area. A) The overall "straight, unsupported travel" can be increased here by a maximum of 50% of the FL_G and in case of option B) by a maximum of 100%

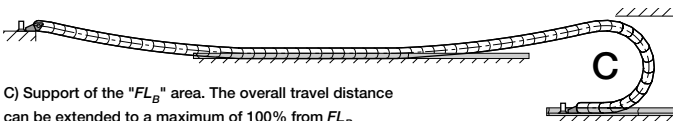

C) Support of the " FL_B " area. The overall travel distance can be extended to a maximum of 100% from FL_B

More application-examples for short travel applications ▶ www.igus.eu

Design
Unsupported

Phone +49- (0) 22 03-96 49-800
Fax +49- (0) 22 03-96 49-222

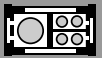



Standard values of max. speed and acceleration:

Unsupported	FL_G	FL_B
v max. [m/s]	20	3
v peak [m/s]	50	-
a max. [m/s ²]	200	6
a peak [m/s ²]	784	-

Standard value of FL_G service life: 10 million cycles



Preferred Series for max. speed and acceleration

- System E6 ▶ chapter 8
- System E3 ▶ chapter 8
- Zipper ▶ chapter 4
- Series 255 ▶ chapter 5
- E4.1 ▶ chapter 7

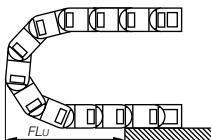

We recommend pivoting mounting brackets as standard! We recommend locking mounting brackets as standard if high speeds > 20 m/s or accelerations > 20 m/s²

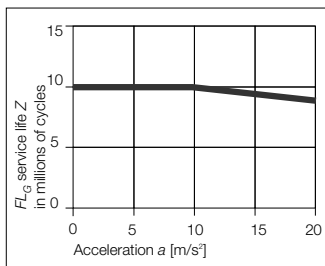

Standard values on service life for FL_G (unsupported, straight), dependent on acceleration

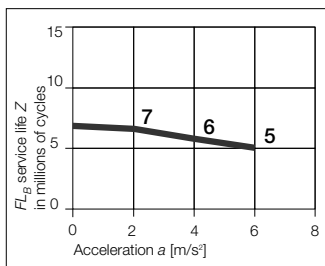

Standard values on service life for FL_B (unsupported, sag), dependent on acceleration

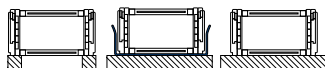

Different surfaces + guide troughs are possible

Mounting brackets

We recommend pivoting mounting brackets as standard for unsupported applications. Pivoting mounting brackets compensate for the camber, can be installed more easily and decrease the load on the first E-Chain® link in operation. **Exception:** If the acceleration is greater than 20 m/s² or if the height is limited to the H_F -measurement, locking mounting brackets keep the E-Chain® under the H_F -measurement.

Unsupported lower run

E-Chains® without support along the lower run have restricted use. The value FL_U usually must be determined in a test by igus®. The maximum permissible amount of the projection depends on the fill weight, the selected E-Chain®, the dynamics, and other factors, because the various combinations of these parameters can produce very different results. **If the lower run of the E-Chain® cannot be supported over the whole travel, please consult igus®.**



System E4 partially unsupported - please consult igus® regarding this type of configuration

Speed, acceleration and service life

For unsupported applications, the acceleration a , is the critical parameter. High acceleration can cause the E-Chain® to vibrate and reduce its service life. This is a particular danger if the E-Chain® already has a sag greater than the FL_G value. Max. values for acceleration, speed and service life are achieved only with E-Chains® incorporating the FL_G design. FL_G designed E-ChainSystems® can sustain very high loads. To date, **a peak acceleration of 784 m/s²** has been achieved during continuous use. Through ongoing testing in the igus® laboratory and from practical experience, standard values for service life have been formulated. Our tests confirm that these standard values apply to all igus® E-Chains® and E-Tubes. It is crucial to determine whether the application will be designed as unsupported straight FL_G or unsupported, with sag FL_B .

Load-bearing surfaces

Unsupported E-Chains® normally require some type of surface on which the lower portion of the E-Chain® runs. A wide range of configurations is available, as the drawings on the right demonstrate. Many material options are feasible: Metals, polymers, stone, wood, concrete, glass, etc. We also have solutions to minimize the noise generated by the chain's lower portion. Please consult igus®. When selecting the running surface, be sure dirt and debris cannot collect in the E-Chain® path.

Minimize noise levels with igus® E-ChainSystems®

The igus® program offers you optimal noise-reduction E-Chains®. The table below briefly illustrates the differences in noise level among various E-Chains®. In addition to the E-Chain®, the running surface, the dynamics and the cable and hose package play a role in overall noise generation. Have our specialists design the quietest E-ChainSystem® for your application, for example:



A reduction of 3 dB(A) sounds like a 50% reduction in the noise level to the human ear



System T3 ≤ 33 dB(A)

Optimal smoothness of motion was the prime development goal, as well as making it an economic solution. The igus® T3 profile chain is very flexible and runs -due to the special geometry- very smooth. A measurement indicates a value of ≤ 33 dB(A) at 1 m/s and with an unsupported length with Series T3.29.050.038.0, and all this with a sound pressure level generated by external noise.



System E3 - low-noise, 38 dB(A)

Long-term tests in the igus® acoustic laboratory showed reductions of 19-20 dB(A) compared with standard E-Chains®, measured at a speed of 1.8 m/s and an acceleration of 3 m/s². Figure determined in the igus® laboratory in accordance with DIN 45635, taking into consideration background noises, for the **Series E3.22.060.044.0**.



System E6 ≤ 46 dB(A)

A measurement conducted by the Rhineland Technical Inspection Authority (TÜV Rheinland) in May 2002 indicates a value of ≤ 46 dB(A) at 2 m/s and with an unsupported length of 1.5 m with **Series E6.52.10.100.0**, and all this with at least 10 dB(A) sound pressure level generated by external noise. The System E6 runs due to their small pitch very smooth. (rest weg lassen, kann ich nicht übersetzen)



System E4 ≤ 46 dB(A)

A measurement by the Rhineland Technical Inspection Authority (TÜV Rheinland) for **System E4/101, Series 221.10.200.0** indicates a value of 46 dB(A) at 1,5 m/s with an unsupported length. Due to the special rubber pads (in red pictured) of the System E4/101, the noise will be extremely damped. The standard version of E4/00 is already very noise reduced due to their special designed stop dog.

Selected noise tests - external noise corrected measurement values

E-Chain® Series	System	Averaging of the corrected sound pressure levels	Test method
igus® Series T3.29	T3	≈ 33 dB(A)	unsupported 1,0 m/s
igus® Series E3.22	E3	≈ 38 dB(A)	unsupported 1,8 m/s
igus® Series E6.52	E6	≈ 46 dB(A)	unsupported 2,0 m/s
igus® Series 221	E4/101	≈ 46 dB(A)	unsupported 1,5 m/s
igus® Series 255	E2 medium	≈ 53 dB(A)	unsupported 1,5 m/s
igus® Series E-Band	E-Band	≈ 59 dB(A)	unsupported 1,5 m/s
igus® Series 280	E4/00	≈ 64 dB(A)	unsupported 2,0 m/s
igus® Series 381	E4/101	≈ 66 dB(A)	gliding 3,0 m/s
Chain 1 Third Party Product		≈ 77 dB(A)	unsupported 2,0 m/s
Chain 2 Third Party Product		≈ 68 dB(A)	unsupported 2,0 m/s
Chain 3 Third Party Product		≈ 73 dB(A)	unsupported 2,0 m/s

Source: TÜV Rheinland, except Series E3.22 - Source: igus® laboratory



We have received an official comment from the Rhineland Technical Inspection Authority (TÜV Rheinland Berlin-Brandenburg) and we are able to provide you with a copy on request



Preferred igus® E-Chains® for minimizing noise

- System E3 ▶ chapter 8
- System T3 ▶ chapter 8
- System E6 ▶ chapter 8
- E4/101 ▶ chapter 7
- E4.1 ▶ chapter 7
- E4/00 ▶ chapter 7
- Series 255 ▶ chapter 5
- Easy Chain® ▶ chapter 3
- Series R58 ▶ chapter 6
- Series R68 ▶ chapter 6

Design Unsupported

Phone +49- (0) 22 03-96 49-800
Fax +49- (0) 22 03-96 49-222

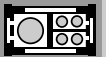

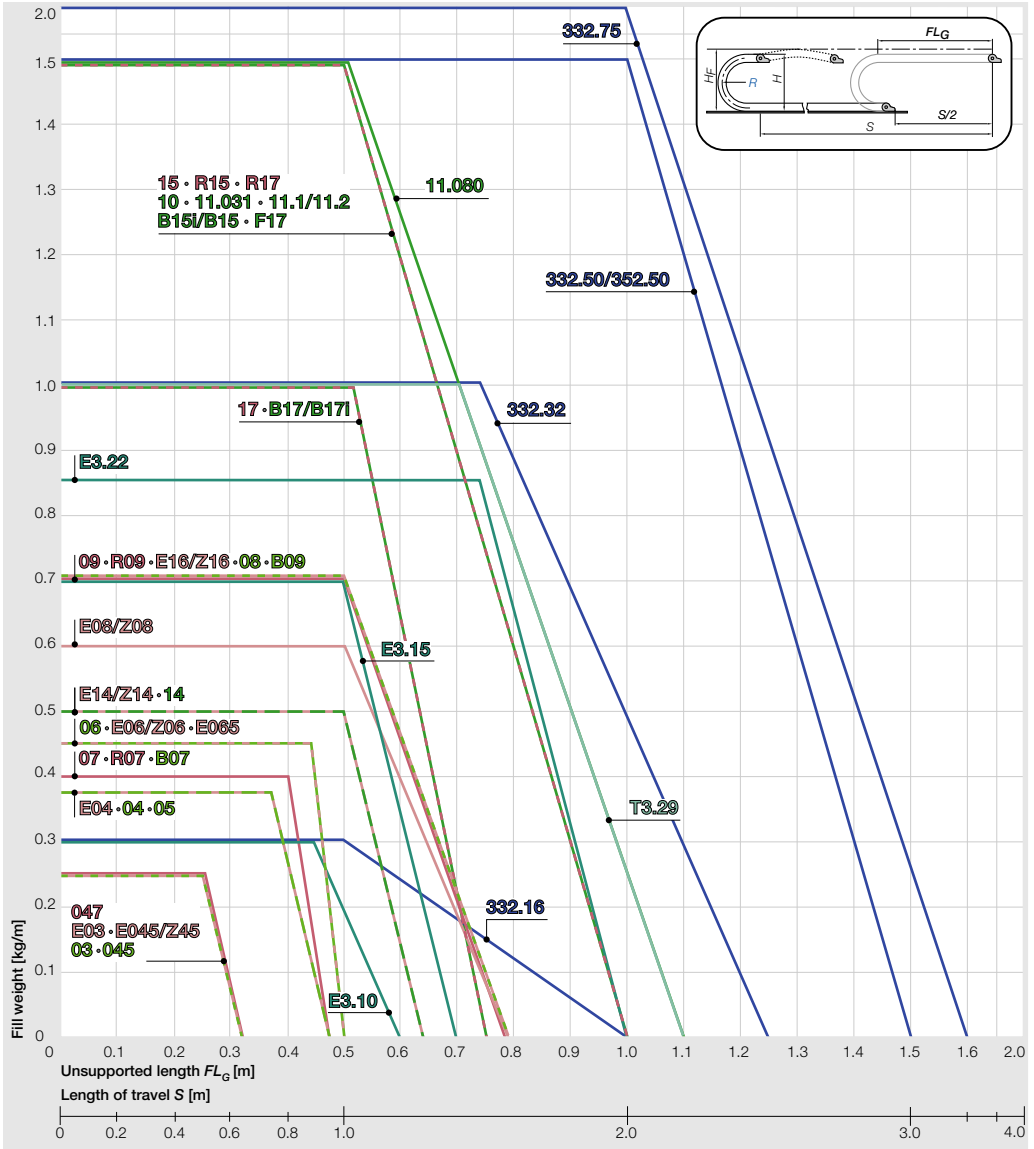

Important information

- Fill weight - Weight of all cables and hoses, including contents (for media hoses) within the E-Chain®, typically given [kg/m]
- FL_G - unsupported E-Chain® with straight upper run
- FL_B - unsupported E-Chain® with permitted sag
- To the right of the FL_B graph of the diagram, the application is shown in "critical sag", which must be avoided!

These values are essential for: ● Finding a suitable E-Chain® for your fill weight and travel distance ● Identifying the max. load for the selected E-Chain®. If you cannot meet your application demands using these parameters, keep in mind these specifications are conservative maximum values. In individual cases, they can be exceeded by up to 30%. Special solutions are also possible. Please consult igus®

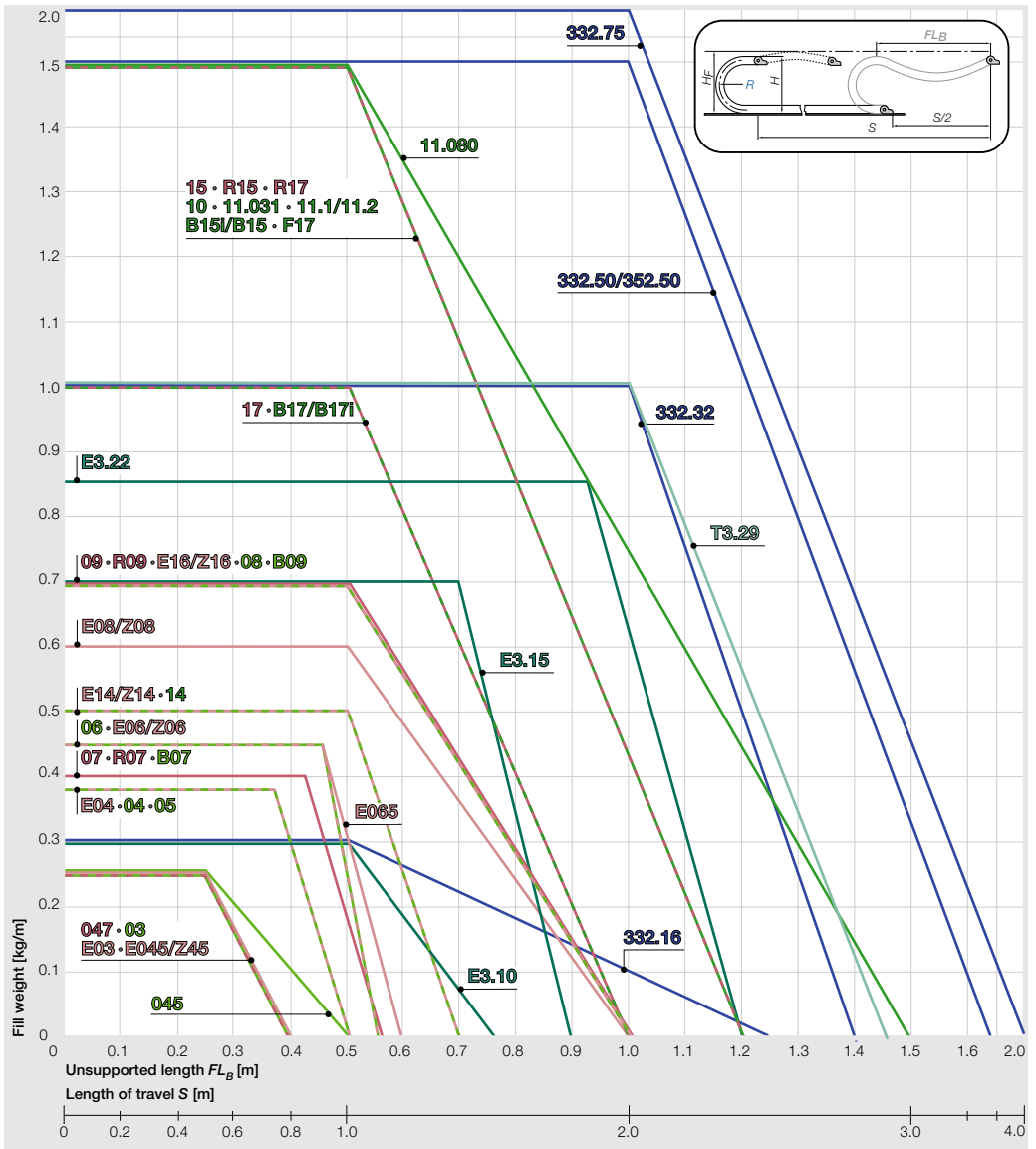

The maximum travel - always amounts to $2 \times 2 \times FL_G$ or FL_B if the fixed end is in the center of the travel. In this case, the following applies:

E-Chain® length: $L_k = S/2 + K$

- S = Length of travel
 - R = Bending radius
 - H = Nominal clearance height
 - H_F = Required clearance height
 - $K = \pi \cdot R + \text{"safety"}$ Add-on for bending radius
- (K is taken from the data tables of the individual igus® series)

Diagramm Series You will find both diagrams for each series listed individually in the catalog!

- Triflex® ▶ chapter 2
- Easy Chain® ▶ chapter 3
- System E3 ▶ chapter 8
- System T3 ▶ chapter 8
- Zipper ▶ chapter 4
- E2 micro ▶ chapter 5
- E2 mini ▶ chapter 5

Find the values for " FL_G " and " FL_B " also ▶ in every individual Series chapter!

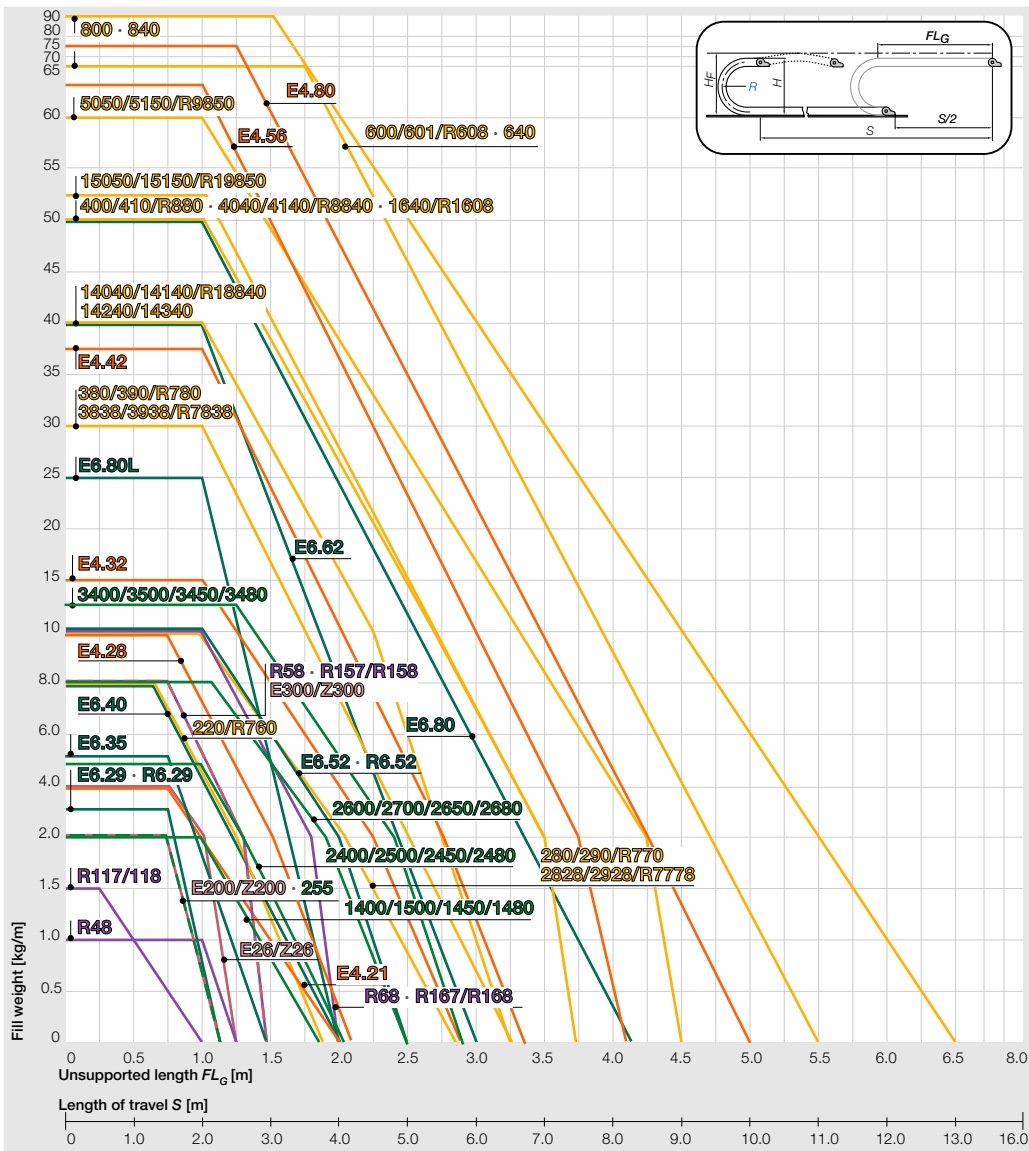

Important information

- Fill weight - Weight of all cables and hoses, including contents (for media hoses) within the E-Chain®, typically given [kg/m]
- FL_G - unsupported E-Chain® with straight upper run
- FL_B - unsupported E-Chain® with permitted sag
- To the right of the FL_B graph of the diagram, the application is shown in "critical sag", which must be avoided!

These values are essential for: ● Finding a suitable E-Chain® for your fill weight and travel distance ● Identifying the max. load for the selected E-Chain®. If you cannot meet your application demands using these parameters, keep in mind these specifications are conservative maximum values. In individual cases, they can be exceeded by up to 30%. Special solutions are also possible. Please consult igus®

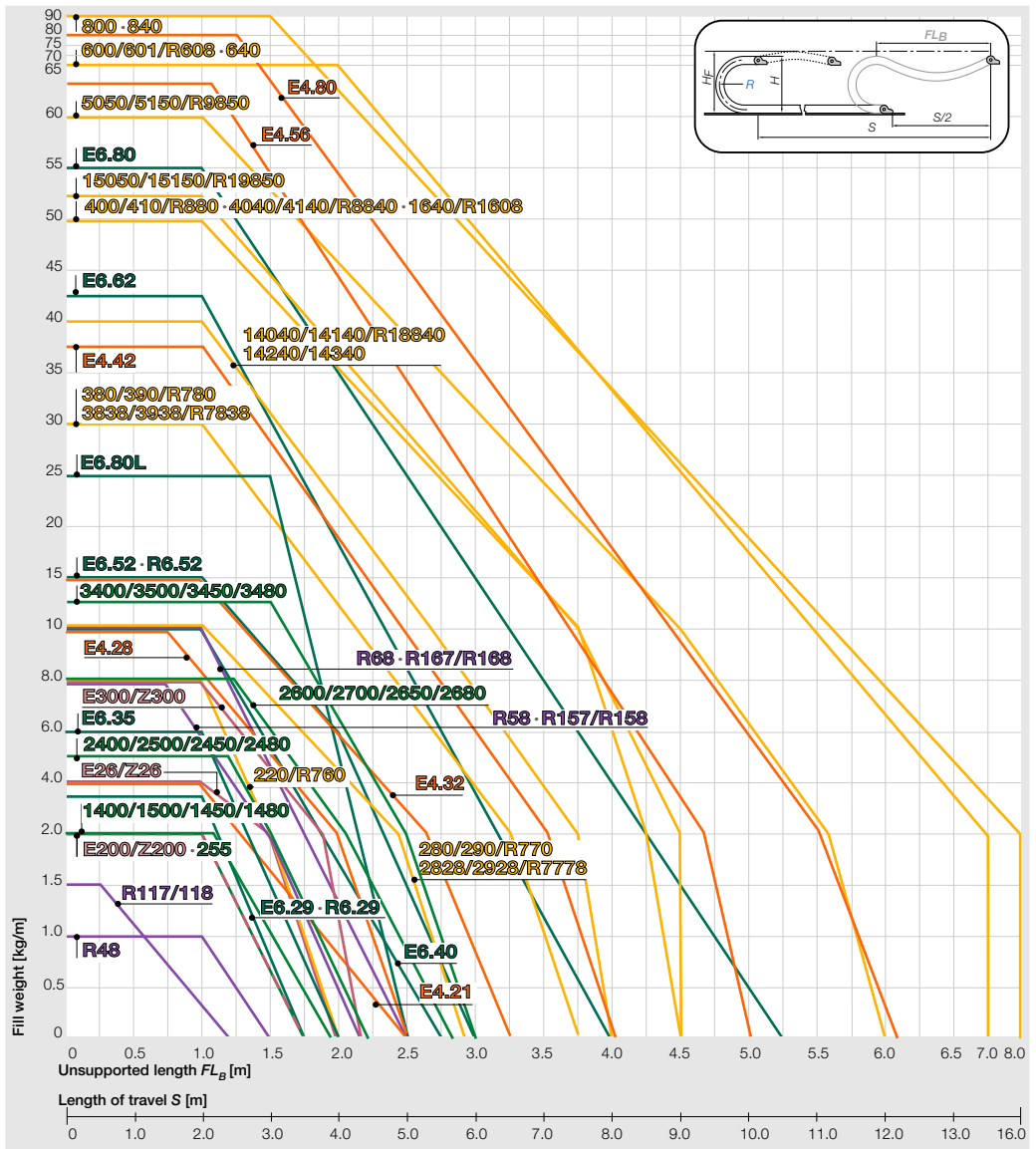

The maximum travel - always amounts to $2 \times 2 \times FL_G$ or FL_B if the fixed end is in the center of the travel. In this case, the following applies:
E-Chain® length: $L_k = S/2 + K$
 S = Length of travel
 R = Bending radius
 H = Nominal clearance height
 H_f = Required clearance height
 $K = \pi \cdot R + \text{"safety"}$ Add-on for bending radius
 (K is taken from the data tables of the individual igus® series)

Diagramm Series You will find both diagrams for each series listed individually in the catalog!

■ Easy Chain®	▶ chapter 3
■ E2/000	▶ chapter 5
■ E2 E-Tubes	▶ chapter 6
■ E4.1	▶ chapter 7
■ E4/00	▶ chapter 7
■ E4/4	▶ chapter 7
■ E4/light	▶ chapter 7
■ E6	▶ chapter 8

Find the values for " FL_G " and " FL_B " also ▶ in every individual Series chapter!



Gliding application -

If the upper run of the E-Chain® rests on the lower run, it is a gliding application



- Over 400 m travel
- 6 m/s speed
(up to 10 m/s possible after consultation with igus®)
- Fill weights up to 70 kg/m



Conveyor belt in quarry. Application with travel distance of 179 m, travel speed 67 m/min., fill weight 8 kg/m

Advantages for long travel applications with igus® E-Chains®

- Travels over 400 m
 - Gliding speeds up to 5 m/s (more in individual cases)
 - Service life of 10 years and more with igus® E-ChainSystems®
- Further advantages of the design are:**
- Many different types of cables and hoses can operate side by side in the same system (i.e. electrical, data, fiber optic cables with hydraulic and pneumatic hoses)
 - Space-saving installation
 - Quiet operation
 - High accelerations
 - Durable in wind, weather, dirt, and chemicals
 - Simple assembly of the modular system on the spot
 - Rapid assembly and replacement of cables and hoses

Design assistance, free of charge

We recommend that igus® calculate every gliding application for you. We will always offer the most cost-effective solution, taking the technical requirements and operating safety into consideration. The system solution designed by us is also automatically given an igus® system guarantee. **To be able to advise you accurately, we require the following specifications:**

- Travel [m]
- Travel speed [m/min] or [m/s]
- Acceleration [m/s²]
- Fill weight [kg/m]
- Maximum cable/hose outer diameter [mm]
- Type and number of cables and hoses
- Required bending radius [mm]
- Cycle frequency (n/day or n/hour)
- Technical environment.

Please call us and within hours you will receive a detailed system proposal!

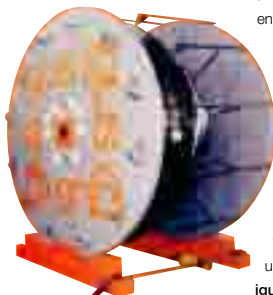

Long travel "off the reel." Up to 100 m travel pre-assembled and ready to install

Trends in long travel applications

Very long travels with igus® Rol E-Chain. - Rolling instead of gliding: 75% less push-/pull forces due to special roller-links. Travels up to 800 m are possible. Longest igus® travel of 615 m with Rol E-Chain® and Chainflex®-cables ▶ igus.de/en/rolechain

Long travel systems "off the reel" - save already at the state of assembling: Complete custom-made E-ChainSystems® with cables, connectors, strain relief - are delivered on the reel and "rolled off" into the preassembled Guide Troughs. Time savings of 50 % possible. Please ask us for references ▶ igus.de/en/readychain

Long travels without guide troughs: Our AUTO-GLIDE system consists of self-guiding E-Chains® for travels up to 50 m travel lengths (speed 1,5m/s) due to special gliding elements on the crossbars ▶ igus.de/en/autoglide

Long travels with very small E-Chains®. Micro Flizz® offers the guidance of cables inside a small E-Chain® with high acceleration on long travel applications ▶ igus.de/en/flizz-n



Preferred igus® E-Chains® gliding, long travels

- System P4 ▶ chapter 9
- Rol E-Chain® ▶ chapter 9
- System E4 ▶ chapter 7
- E2/000 ▶ chapter 5



Longest igus® travel of 615 m with Rol E-Chain® and Chainflex®-cables

Gliding applications principle

For long travels, the upper run of the igus® E-Chains® rests on the lower run. The upper run glides partially on the lower run and partially at the same height on a glide bar. The diagrams below show this. For lateral guidance, a Guide Trough is necessary. If the stationary mounting bracket and the fixed end of the cables and hoses can be placed **in the center**, the chain length is calculated as follows: $L_k = S/2 + K$. Depending on the technical data and the selected E-Chain®, the mounting point of the moving end of the E-Chain® must be lowered on some units ► **Lowered mounting height**. In our system analysis for long travels, we give exact details for your specific application.



Example of lowered mounting height



Advantages lowered

moving end:

- Space saving
- Longer travels possible
- Higher service life due to less wear

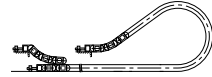

Example: Series 3838

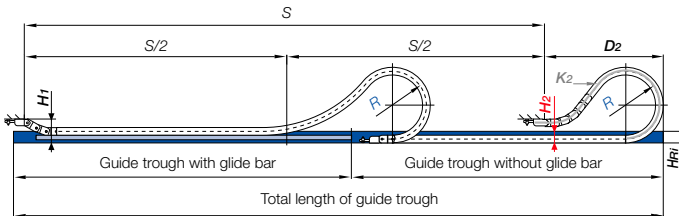

The function of an E-ChainSystem® for gliding applications (schematically)

The fixed end of the E-Chain® is located in the center of the travel distance

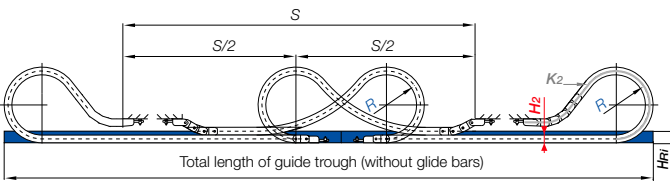

For a configuration involving two opposed E-Chains®, the travel is measured as shown and selected when these factors apply: ● Restricted space ● High loads

E-Chain® length:

$$L_k = S/2 + K_2$$

S = Length of travel

R = Bending radius

H_{RI} = Trough inner height

H_F = Required clearance height

K₂ = Further add-on if the mounting bracket location is set lower (specified by igus®)

$$K = \pi \cdot R + \text{"safety"}$$

Add-on for bending radius (K is taken from the data tables of the individual igus® Series)

D₂ = Over length for long travels gliding

H₂ = Installation height with lowered mounting

● Guide trough

● Glide bar



Recommended ratio of E-Chain® inner width *Bi* and bending radii *R* (on long travels)

The min. inner widths of an E-Chain® on long travels depend on the bending radii of the E-Chain®.

$$\text{igus® specifies: } B_{i_{\min.}} = R/4$$

Please contact igus® if you have large bending radii on long travel lengths.



Gliding applications = Pivoting mounting brackets



Mobile camera, Olympic Games in Atlanta, S = 100 m, v = 10 m/s in push-pull operation



Robotics: quiet running, high acceleration, up to 10.000 cycles per day, System E4/4

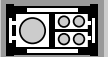
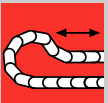



Guide troughs are used for long travels. They allow igus® E-Chain® and E-Tubes to continue smooth, low-friction operation in these long-travel situations. Various guide trough systems are available ► Guide Troughs, chapter 9



If the fixed point is in the center of the travel, use half of the guide trough with glide bars ... and the other half of the guide trough without glide bars



Guide troughs

The guide trough is an important element in long travel applications. Usually, the height of the trough must be at least twice that of the E-Chain® link height. The sides must provide a chamfered opening. The trough inner width is the same as the E-Chain® outer width, plus 5 mm ($B_{Ri} = Ba + 4$). Along the side of the trough, where the upper run cannot glide on the lower run, glide bars must be installed. We recommend the

use of polymer glide bars from igus®. They are optimally matched to the E-Chain® material and achieve the lowest values for friction, noise and wear. Guide troughs with and without glide bars can be obtained for almost all igus® E-Chains®. **Important: When assembling the trough parts, the following points must be given particular attention:** ● Properly align all trough parts upon installation ● All screw heads should be flush with the trough ● Smooth levelled transition between the end of the E-Chain® and the glide bars ● Solid connection with the glide surface. **These points must be observed when using assembly-friendly igus® guide troughs.**

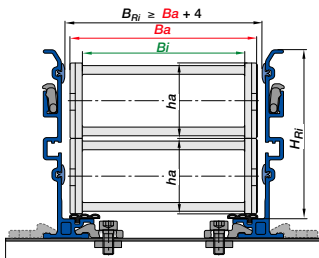

Demonstration: Guide troughs without glide bars - upper run glides on the lower run.

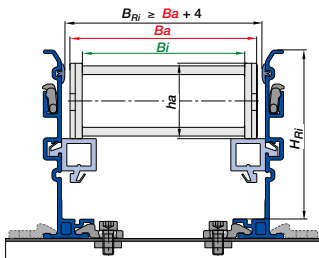

Demonstration: Guide troughs with glide bars. We recommend the use of polymer glide bars from igus® made of igulen. They are optimally matched to the E-Chain® material and achieve the lowest values for friction, noise and wear.

- Ba = E-Chain® outer width
- Bi = E-Chain® inner width
- ha = E-Chain® outer height
- H_{Ri} = Inner trough height
- B_{Ri} = Inner trough width ► depending on Ba

$H_{Ri} \approx 2 \cdot ha$
 $B_{Ri} \approx Ba + 4$

- = Guide trough-set
- = Glide bar
- = Installation set*Basic*
- = C-Profile

Glide friction values for igus® E-Chains® made of igumid G and various glide bars

	igus® polymer special bar igulen	Glide sheet steel	Anodized aluminum	Stainless steel
Friction value dynamic	0,19	0,45	0,54	0,48

Source: igus® laboratory

Travel speeds and accelerations

Travel speeds up to 5 m/s in continuous operation are possible and in use on current applications. In special cases, even higher speeds are possible. For example, E4/00 and E4/4 E-Chains® achieve **speeds of 22 m/s and accelerations of 784 m/s²** in crash test units. (Only a few thousand cycles per year are required in this situation.) Acceleration plays a large role in the calculation. Differentiations must be made between normal operational acceleration and a sudden jolt of acceleration such as unexpected stops or so-called "E-stops." Even in these situations, igus® E-Chains® prove to be very durable.

Service life

We offer service life calculations for your application based on our extensive gliding application experience. As developers of polymer plain bearings, we possess vast material behavior knowledge which we apply to the development of E-Chains® as well. Units with 200 m travels have been in operation for 8 years with



Automated storage/retrieval system with System E2 and Chainflex® cables - travels up to 80 m and speed of 4.5 m/s

minimum maintenance. Units up to 60 m travels have been in operation for 12 years with almost no maintenance. (Please consult igus® for references and calculations for your project.) The maintenance-free aspects of igus® E-ChainSystems® over long periods and under rough operating conditions is often the deciding factor in choosing igus®. Our system guarantee (depends on the application) provides additional peace of mind.

Technical environment

Long travel applications using igus® E-Chains® run in water, in dirt, in the tropics, in explosion risk areas (with special design features) and many other conditions. Guide troughs can be supplied in corrosion-free materials. You will find more details in the Technical Environment section of this chapter.

Calculation

Comprehensive tests place us in the position of knowing our products precisely. Important factors in these tests are: ● Push-pull forces under both ambient and extreme temperatures ● Humidity and dirt ● Friction values of the polymers, alone and against various glide surfaces ● Behavior of electrical conduits under push-pull conditions ● Behavior of hydraulic and media hoses under push-pull conditions ● Service life, and noise generation. **If we cannot in fact calculate your application based on these factors, we will perform a practical test for you in our laboratory. Please consult igus®.**



E4 in a pre-cast concrete plant with dust and concrete sediment

Technical data - long travels

Travel max	600 - 800 m
Travel speed max	10 m/s
Travel acceleration max	dependent on calculation, can be 50 m/s ² and more
Fill weight maximum	dependent on calculation, can be 70 kg/m and more



Corrosion-free guide troughs are available in the material:

- Normally galvanized
- Stainless steel
- Seawater resistant aluminum

Special properties - Long travel applications

E-Chains® that are **nested** can be used in gliding applications. This type of installation is most often used when there is a width restriction. Guide troughs with special wall heights are necessary, E-Chains® **running side by side**, or in a "multiband" design can also be used in gliding applications. Higher fill weights often require special guide troughs which can be delivered either from stock or on short notice. We have also developed standard parts for unconventional solutions involving **large hoses** in gliding applications.



Nested, gliding E-Chains®



"Multiband" E-Chain®

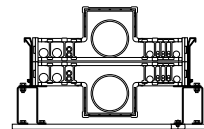

Large hose elements

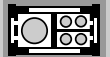
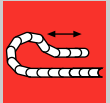



We recommend locking mounting brackets for hanging applications. In restricted spaces, other solutions are possible with consultation

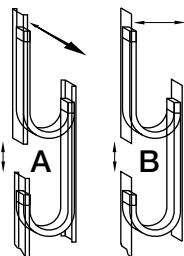
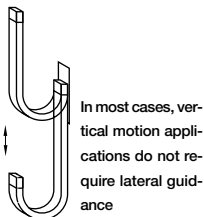

Lateral acceleration can occur in two directions - guidance is necessary

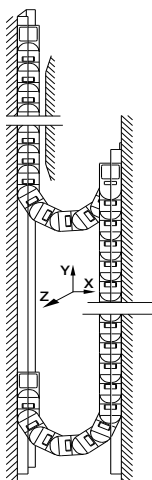

Principle of a hanging E-Chain® with lateral guidance - lateral accelerations in both directions are intercepted



Vertical, hanging applications

In accordance with the principle of "hanging" applications, heights of over 100 m are possible with igus® E-Chains®. Chains with interior separation allow many different types of conduits to operate together in the same system without becoming entangled.

Cables and hoses

Two important factors in vertical hanging applications are how the conduits lay in the E-Chain® and how they are secured at the end points: All cables and hoses must be hung so that they bear their own weight. The E-Chain® fulfills the function of orderly conduit bundling only and should not absorb any further tensile forces.

igus® interior separation elements should be used for distinct division of all cables and hoses. **The cables and hoses must be secured carefully to both end points of the E-Chain®.** The strain relief must be designed so that the opposite run cannot catch. **Safe strain relief and clear separation of the conduits are the basic prerequisites for hanging installations - Cables must be able to move freely and bear their own weight.**

Camber

A normal igus® E-Chain® with camber is suitable for hanging use if enough space is available. If there is no room - as is frequently the case for storage and retrieval systems in narrow aisles - a "no camber" E-Chain® must be ordered. **Order example: 2700.07.100.0.NC (NC = no camber).** These versions are offered at no additional charge (Exception: System E2 E-Chains® + 6%), but with a slightly longer delivery period - usually 1-2 business days longer.

Vertical motion without lateral acceleration

If the application involves vertical motion without lateral acceleration, the E-Chain® can be installed without lateral support. If the space restrictions are severe, an igus® E-Chain® with no camber must be specified.

Vertical motion with lateral acceleration

If lateral acceleration occurs, lateral guidance of the E-Chain® must be provided in most cases. The diagram to the right shows the principle of such guidance. Partial guidance is also an option - however, it must at least cover the area in which the E-Chain® may sway. Lateral acceleration can occur in two directions. The lateral guidance must be installed accordingly. If you have a choice, the layout in **Figure A** is preferred. Additional guidance along the side of the E-Chain® helps to stabilize the chain further.

Guidelok vertical - no swinging sideways of the E-Chain®

The problem: Suspended E-Chains® swing out due to transverse acceleration - **The solution:** igus® "Guidelok" system. E-Chain® stays on track even with acute transverse acceleration! When the chain moves over the control button ① the fixing button ② is moved, the lower run of the E-Chain® held in place, preventing it swinging out. For elevators, racking units, material handling equipment. igus® For vertical applications with lateral motion, igus® Guidelok offers a simple, costeffective and safe system solution. Please call us if you're interested in this product! **Typical applications** ● Automated storage/retrieval systems ● Lifts ● Revolving storage systems ● Diagonal lifts ●

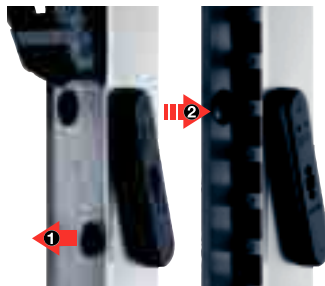

All vertical applications ► page 9.98

Video ► www.igus.eu/guidelok

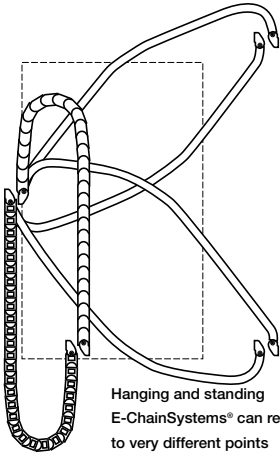

Hanging and standing E-ChainSystems® can reach to very different points



Hanging assembly with one-sided U profile

Technical data - vertical hanging

Travel height max:	100 m
v max:	20 m/s dependent on height and stability of the E-Chain®
a max:	50 m/s ² dependent on height and stability of the E-Chain®

"Zig-Zag" design

The modular design of igus® E-Chains® facilitates this space-saving and unconventional solution. For modern platform technology, such as performance stages, a variety of conduits which adjust the stage height must be accommodated. Lack of space almost invariably presents particular difficulties. The photo below shows an E-Chain® in a "Zig-Zag" configuration produced by incorporating reverse bend radii or "RBR". The unextended E-Chain® is stored in a "basket" underneath the stage. If the stage is raised, the E-Chain® unfolds, generating little to no noise. This construction is possible with System E4/4 E-Chains® as well as many other types. Please consult igus® for these kinds of applications.



With the E-Chains® of the Systems E4 - "Zig-Zag" solutions can be realised quickly and cost-effectively without special parts



System design

Due to the wide variety of combinations involving stroke height, cable/hose packages, dynamic values, and application environments, we strongly recommend you make use of our consulting services. Simply call, E-mail or fax us.



Preferred Series for vertical, hanging design

- E4.1 ▶ chapter 7
- E4/00 ▶ chapter 7
- E4/4 ▶ chapter 7
- E2/000 ▶ chapter 5
- E2 E-Tubes ▶ chapter 6



Preferred Series for "Zig-Zag" design

- E4/4 ▶ chapter 7

Design Vertical - Hanging

Phone +49- (0) 22 03-96 49-800
Fax +49- (0) 22 03-96 49-222

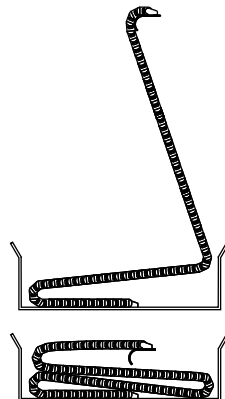
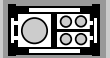

Space-saving solution - stroke heights of over 20 m are possible



We recommend locking mounting brackets for standing applications



Standing application with support of the first E-Chain® links - R68 E-Tube

Phone +49- (0) 22 03-96 49-800
Fax +49- (0) 22 03-96 49-222



Cables must be able to move freely and bear their own weight



Locking KMA mounting brackets
Series 4040 E4/4

Mounting brackets

The mounting brackets must be attached so that the E-Chain® cannot bow out. The igus® program offers locking or one-sided, locking mounting brackets for almost all types of E-Chains®. Locking KMA mounting brackets are highly recommended because they can be attached flush to the machine.

Cables and hoses

Cables and hoses must be laid in the E-Chain® so that they can bend freely. For precise guidance of the cables and hoses, we strongly recommend igus® interior spacer modules. Cables must be strain relieved at both ends.

igus® GmbH
51147 Cologne



Preferred Series for vertical, standing applications

- E4.1 ▶ chapter 7
- E4/00 ▶ chapter 7
- E4/4 ▶ chapter 7
- E2/000 ▶ chapter 5
- E2 E-Tubes ▶ chapter 6

Technical data - vertical - standing applications

Max. stroke height - without support	≈ 4 m
Max. stroke height - with support of the first E-Chain® links	≈ 6 m
Max. stroke height - with full support	≈ 20 m
v max (dependent upon stroke height and weight)	20 m/s
a max (dependent upon stroke height and weight)	50 m/s²

Internet: www.igus.eu
E-mail: info@igus.de



U-shaped supported E-Tube for high lateral acceleration

Lateral acceleration

If lateral acceleration occurs, the E-Chain® should be supported along the outer radius. For higher E-Chain® heights, it is generally recommended that at least the first three links on the outer radius be supported. For maximum heights and weights, the whole distance must often be supported. **Due to the wide variety of combinations involving weights, stroke heights, E-Chain® types and bending radii, we strongly recommend you make use of our consulting services.**

Combined movements

Combined vertical and horizontal movements are possible with igus® E-Chains® for a cost-saving solution.



Combined horizontal and vertical movements

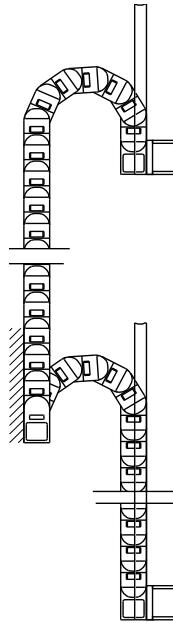

Options for a standing application with support of the first E-Chain® links: on the right, with U-shaped guidance - on the left, with the support of the first chain links



For higher E-Chain® stroke heights, it is generally recommended that at least the first three links along the outer radius be supported. For maximum heights and strokes, the whole E-Chain® must often be supported.

With lateral acceleration, the E-Chain® must be supported and, depending on the direction of this acceleration, be guided along the side

Design
Vertical - Standing

Phone +49- (0) 22 03-96 49-800
Fax +49- (0) 22 03-96 49-222

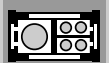
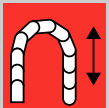

igus® E-ChainSystems®

Phone +49- (0) 22 03-96 49-800
Fax +49- (0) 22 03-96 49-222

igus® GmbH
51147 Cologne

Internet: www.igus.eu
E-mail: info@igus.de



Side-mounted E- Chains® - are strongly recommended if the installation height is restricted

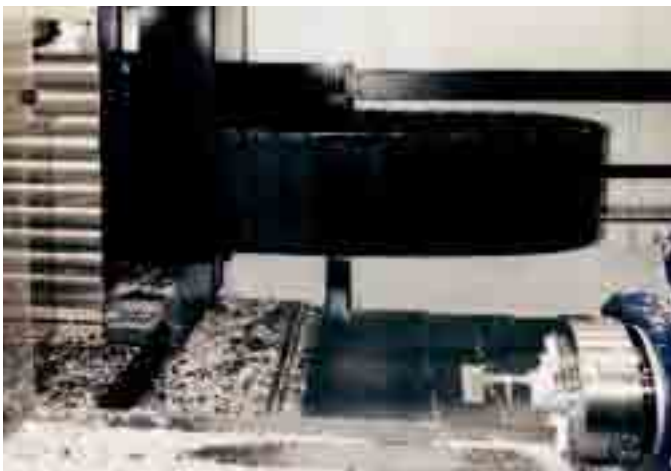

System E4/light E-Tube in direct chip area



Standard values for unsupported lengths, side-mounted, upon request. The unsupported lengths can be extended by supporting the links next to the mounting brackets

Short travels with or without support

igus® E-Chains® placed on their side can be used unsupported to a limited extent. The turned "unsupported length" in this case is dependent on the following factors: ● **Fill weight** ● **Width of the E-Chain®** ● **Bending radius** ● **Parallel placement**. The greater the fill weight of the E-Chain®, the shorter the available unsupported length. When placed on its side, the E-Chain® width, in effect, becomes the height. As this "height" increases, the E-ChainSystem® becomes proportionally more stable. Small bending radii provide greater stability. If further movement in a second axis is added to the parallel motion of two chains, the unsupported length is impaired. For applications with low fill weight, the standard mounting brackets are adequate. If, however, the fill weight is high and the travels are long, the E-Chain® must then be supported either in whole or in part. Due to the variety of application possibilities, we strongly recommend you make use of our consulting services.



igus® - Series E4/4
with partial support



Unsupported - System E4



E-Chain®, side-mounted, supported System E4

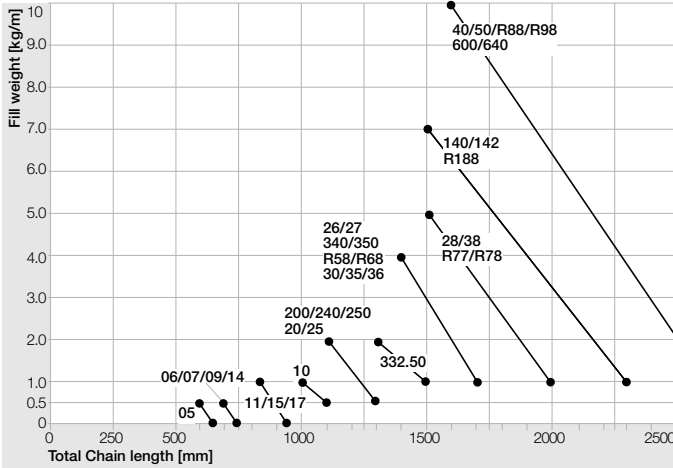

The unsupported lengths can be extended by supporting the links next to the mounting brackets
Please consult igus® for more Series and details!

Long travel, gliding

Side-mounted E-Chains® can travel over 100 m with adequate guidance. All E-Chain® types are designed to operate gliding on their side. The corresponding glide surface is usually an igus® polymer, stainless steel or galvanized steel, depending on how high the demands on the travel speed and service life are. Roller and ball bearings or additional gliding elements are not necessary for igus® E-Chains®. The diagram below shows the principle of a guide trough for side-mounted applications.

Cables and hoses

Cables and hoses must be guided so that the E-ChainSystem® can move freely at all times. The igus® modular separation options offers numerous possibilities, such as **vertical separators and spacers**, to keep these conduits separated and bending freely for maximum service life. igus® will gladly provide an application analysis, free of charge.

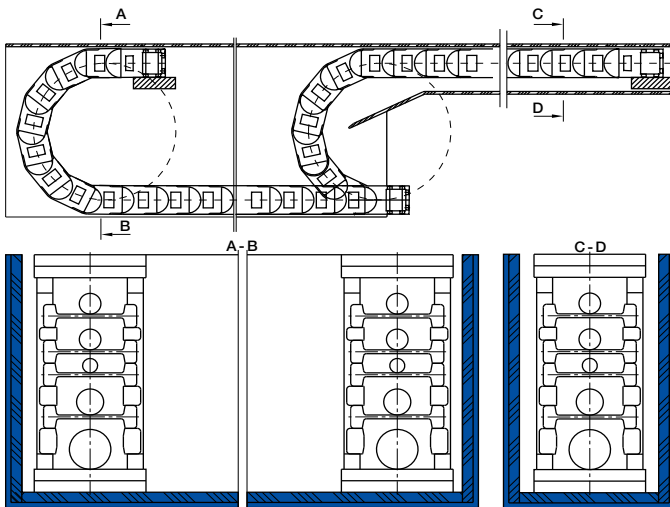

Principle of a guide trough for long travel, side-mounted



For a side-mounted gliding application, we recommend locking mounting brackets. The E-Chain® is then pushed straight through the guidance



The igus® separation elements also offer safe solutions for heavy hydraulic hoses



Cable and hose guidance with separators and spacers



Preferred Series for side-mounted applications

- E4.1 ▶ chapter 7
- E4/4 ▶ chapter 7
- E4/00 ▶ chapter 7
- E2 E-Tubes ▶ chapter 6

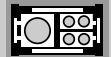
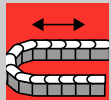

igus® E-ChainSystems®

Phone +49- (0) 22 03-96 49-800
Fax +49- (0) 22 03-96 49-222

igus® GmbH
51147 Cologne

Internet: www.igus.eu
E-mail: info@igus.de



Options 2. and 3. for rotary movements require less installation height. The E-Chains® glide mostly on surfaces made of polymer, stainless steel or steel and are guided through channels into a rotary movement. (See "side mounted" for further design tips.)

Bending radii, circular radii and E-Chain® widths are variable with this product line

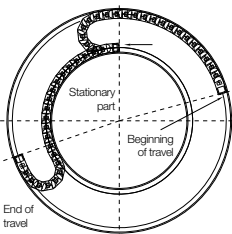

Preferred Series for rotary motion applications

- All "RBR" E-Chains®
- TwisterChain® ▶ chapter 2
- System E4 ▶ chapter 7
- E2/000 ▶ chapter 5

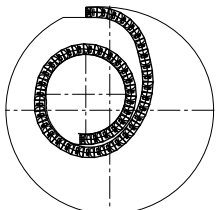
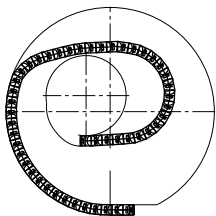

Standard E-Chain®
3500.075.200.0,
angle of rotation 225°



Rotary motion with a "standard" E-Chain®



"RBR"-rotary movement with Series 5050, installed on a crane

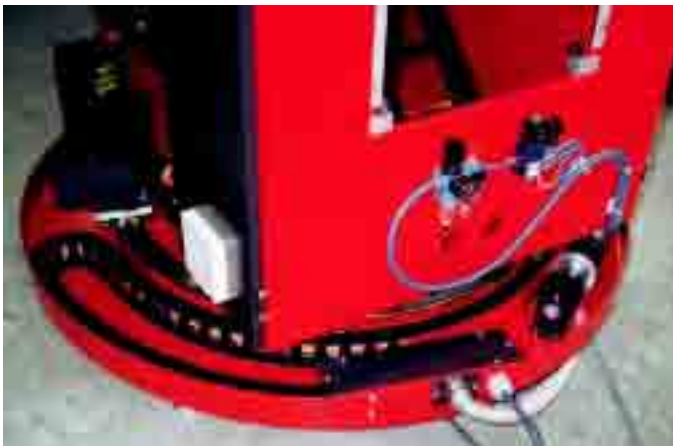

Series 250 with 360° RBR rotary motion on a robot

1. Rotary motion with TwisterChain®

The TwisterChain® product line offers the biggest selection for rotary movements. TwisterChain® solutions are particularly recommended for space-restricted applications such as articulated robots, revolving tables, etc.

2. Rotary motion with standard E-Chains®

The photo to the right shows an application which was achieved using "standard" E-Chains® (in this case, standard means that the E-Chain® only bends in one direction). Such solutions are possible if a **great deal of space** is available and if the angles of rotation are limited to a maximum of 450°. All igus® E-Chains®, E-Tubes and Chainflex® cables are appropriate for this situation.

3. Rotary motion with "RBR"

"RBR" is "reverse bending radius" and means that the E-Chain® can bend in two directions. Each igus® E-Chain® can incorporate RBR designs, with the exception of several radii, for the E-Tubes R117 to R9850 and for the Series 07, 09, 14, 15, and 17. The RBR does not necessarily need to be identical to the normal bending radius of an E-Chain®. For example: Part No. **280.15.100/425.0**, describes a Series 280 E-Chain® with an inner width of 150 mm, standard bending radius of 100 mm and RBR of 425 mm. Most rotary motions can be achieved with the RBR option. **Angles of rotation up to 540°** have been realized. Below is an example of rotary motion using an RBR E-Chain®. Please consult igus® for your particular application.

Guide troughs

Depending on the dynamics and load of the application, the guide troughs are made of steel or stainless steel. For applications with a high cycle frequency, we suggest coating the guide troughs with polymer. igus® E-Chains® require no additional gliding elements for contact with the base or sidewalls. igus® offers complete systems including guide troughs, but we are pleased to offer support with drawings for your own construction.

Product range

E-Chains® with "RBR" are available as standard from stock for the complete Triflex® range. In addition, we supply a number of E-Chains® which are equipped as standard with "RBR". For all other types, "RBR" means custom-made, and we will be more than willing to offer you this option. igus® E-Chains® with "RBR", available as standard **Easy Triflex®/Triflex®**.



Guide troughs for rotary motion applications



Many igus® E-Chains® are available with "RBR" - reverse bending radius. Please note the information text of the relevant Series in the product range

Example:

10.4.075/220



Technical data

rotary motion:

max. angle of rotation = 540°

(larger angles possible)

v max. = 10 m/s

a max. = 20 m/s²

Rotary motion with RBR, diameter 6000 mm, with RBR, the inner ring rotates

Table of "RBR" E-Chains® available from stock

Part No.	Series	chapter	Part No.	Series	chapter
05.16.018/018	E2 micro	5	240.05.060/060	E2 medium	12
06.20.018/018	E2 micro	5	240.07.060/060	E2 medium	12
06.30.018/018	E2 micro	5	2400.09.055/250	E2/000	5
06.64.018/018	E2 micro	5	250.05.060/060	E2 medium	12
10.1.028/028	E2 mini	5	250.07.060/060	E2 medium	12
10.1.038/600	E2 mini	5	27.07.075/300	E2 medium	12
10.1.048/048	E2 mini	5	2700.15.150/090	E2/000	5
10.1.075/220	E2 mini	5	27i.12.125/400.0	E2 medium	12
10.2.028/028	E2 mini	5	28.00.063/063	E4/0	12
10.2.038/600	E2 mini	5	38.00.125/125	E4/0	12
10.2.048/048	E2 mini	5	40.00.135/135	E4/0	12
10.2.075/220	E2 mini	5	40.00.200/200	E4/0	12
10.3.028/028	E2 mini	5	5050.00.150/150	E4/4	7
10.3.038/600	E2 mini	5	B15i.050.100/460	E2 mini	5
10.3.048/048	E2 mini	5	EZ14.1.038/038	Easy Chain®	3
10.3.075/220	E2 mini	5	EZ14.2.038/038	Easy Chain®	3
10.4.028/028	E2 mini	5	EZ14.3.038/038	Easy Chain®	3
10.4.038/600	E2 mini	5	EZ14.3.075/075	Easy Chain®	3
10.4.048/048	E2 mini	5	EZ14.4.038/038	Easy Chain®	3
10.4.048/400	E2 mini	5	TE14.50.028/028	SnapChain	3
10.4.075/220	E2 mini	5	TE26.120.063/063	SnapChain	3

- Chainflex® cables with TPE-outer jacket are specially suitable for E-Chains® with "RBR" option
- Please use for E-Chains® with "RBR"-option a strain relief only for the moving end

The E-Chain® Series appearing on the table are "RBR" - versions available from stock. Almost all igus® E-Chains® can be delivered as a "RBR"-version. Please contact us for any special inquiry

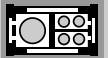



Rules for:

- Maximum conduit diameters
- Separation
- Bending radius

Electrical cables need at least 10% reserve space all around, hydraulic hoses 20%



Hydraulics and electric cables are separated from one another in this example

each conduit within the E-Chain® and the space allowed, are important for the service life of the system. Various separation options enable the adaptation of the E-Chains® to the specific requirements of each respective application. In this chapter, we give you detailed recommendations. Due to the variety of the application parameters, we strongly recommend you take advantage of our free consultation services. Simply give us a list of your cable requirements (or merely the required electrical or other services) and you will receive our recommendation by the end of the next business day.

General rules for cables and hoses in E-Chains®

The key advantage of an igus® E-ChainSystem® is the safe accommodation of various forms of data cables and energy suppliers in one system. We recommend the optimal separation layout of the conduits in the E-Chain®, but you, the customer, are still afforded the final choice. It is possible, for instance, to maintain minimum distances between bus and motor cables and mix pneumatics, electric and hydraulics in the same compartments. In addition to the quality of the cables used, the arrangement of

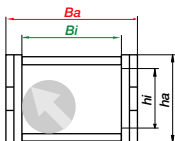

The maximum conduit diameter is specified for each Series on its respective page

Maximum cable and hose diameters

The maximum cable and/or hose diameter corresponds to the inner height of the selected E-Chain®/E-Tube, with additional minimum clearance. This minimum clearance would be, for example, 10% for electrical round cables, 20% for hydraulic hoses. An E-Chain® is ideal if a minimum lateral gap to the next cable or hose has been factored in. Depending on the nature of the cables, the dynamics, and the expected service life, more clearance must be allowed. In specific cases, clearances may be altered further. Please consult igus.



E-Chain®-Distribution

Cables and hoses with very different diameters should be laid separately. The separation is achieved using modular separators. Cables and hoses must **under no circumstances** have the opportunity to tangle. Therefore, the clearance height of a compartment with several similar cables or hoses next to one another **must not amount to more than one and a half times the cable/hose diameter.**



Neatly laid cables with igus® interior separation



Orderly layed cables with igus® interior separation

Reasons for distribution rules

The cables and hoses must be laid so that they can move freely at all times and so that no tensile force is exerted at the radius of the E-Chains®. For high-speed applications and high cycles, cables or hoses must not be laid on top of each other without horizontal separation. The standard values for this are: Travel speed over **0.5 m/s** and cycles over **10,000 p.a.** igus® interior separation offers a safe solution for this situation.

Further guidelines for distribution

The cable or hose weight should be symmetrically distributed along the width of the E-Chain®. Cables and hoses with different outer jacket materials must not be allowed to "stick" together. If necessary, they must be laid separately. All igus® Chainflex® cables can be combined with each and other brands of cable or hose. The cables and hoses should always be fixed at the moving end. The fixed end should always involve strain relief. Exceptions are made only for certain hydraulic hoses with length compensation issues or other high pressure hoses (i.e. hydraulic hoses). **Generally, the faster and more frequently the E-Chain® operates, the more important the exact positioning of the cables and hoses inside the chain. Due to the wide variety of the possibilities, we strongly recommend you take advantage of our free consultation services for your specific applications.**

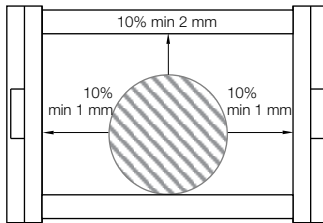
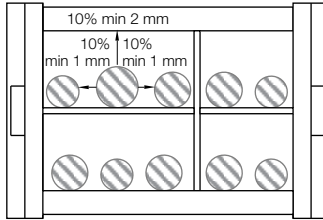
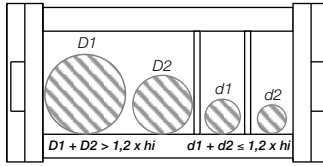

Clearance space "all around"
for round electrical cables

Distribution rules:

$$D1 + D2 > 1,2 \times hi$$

Rule 1:

If $D1 + D2 > 1,2 \times$ E-Chain® inner height, no separation between the two cables/hoses is necessary. Two cables/hoses should never be left unguided on top of one another or be allowed to become tangled.

$$d1 + d2 \leq 1,2 \times hi$$

Rule 2:

If $d1 + d2 \leq 1,2 \times$ E-Chain® inner height, a vertical separator or a horizontal shelf must be used to reduce the inner height, thereby preventing the entanglement of $d1$ and $d2$.

All-around clearance space in % for various cables/hoses

- Electrical round cables: 10%
- Electrical flat cables: 10%
- Pneumatics: 5-10%
- Hydraulics: 20%
- Media hoses: 15-20%

Bending radius R

The bending radius of our E-Chain® depends on the "thickest" or "stiffest" cable or hose in your application. The bending radii of the E-Chains® should be adjusted to the recommendations of the cable or hose manufacturer. The selection of a larger radius than the minimum will positively affect service life. The specification of minimum bending radii for cables and hoses refers to use at normal temperatures - other bending radii may be recommended. Please ask your cable or hose supplier for details.



The igus® program offers up to 12 different bending radii from stock. Here, Series 50 used in the Storebaelt bridge project

We recommend complete E-ChainSystems® - where bending radii for all cables and hoses, interior separation and service life are optimally matched.

igus® Chainflex® cables permit the smallest bending radius of $5 \times d$ for one million strokes

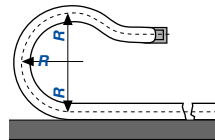

Pinciple sketch
bending radius "R"



Chainflex® cables - smallest bending radius of $5 \times d$

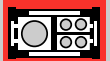
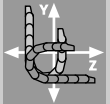



We will be pleased to provide you with recommendations for complete E-ChainSystems®: Bending radii of all cables and hoses, interior separation and service life are then optimally intermatched.



Corkscrewing: an effect of improper cable and hose placement in an E-Chain®



Example from igus® test laboratory: continuous development and testing of Chainflex® round electrical cables

Round electrical cables

For electrical cables, the round cable is a safe, modular and cost-effective solution for E-ChainSystems®. We recommend the following criteria for selecting the proper round electrical cables:

- Strain relief integrated directly into the mounting bracket
- Uncomplicated installation process - no hanging, laying out, etc., of cables
- Long service life at minimum bending radius
- Service life expectations for your application (short or long travel, hanging, etc.)
- Test data on service life from realistic tests
- Flexible shields for shielded cables
- Abrasion-resistant and non-adhesive outer jackets
- Large selection to avoid expensive custom designs.

For bus cables and fiber optic cable, special attention must be paid to how effective transmission rates and shielding remain after millions of cycles at the minimum bending radius.

Installation and strain relief of round electrical cables

- 1** The cables must be laid straight, without twisting. Cables must not be uncoiled from the top of the spool. igus® Chainflex® cables are immediately ready for placement directly into the E-Chain®. They need not be disconnected or laid out before installation.
- 2** The cables must be laid so that each individual cable can move freely from side to side.
- 3** The cables must be able to move freely along the radius. This must be double-checked if the upper run operates at the cable's maximum bending radius.
- 4** The division of the E-Chain® interior using shelves or igus® interior separators is necessary if several cables and/or hoses with varying diameters are laid out. It is important to prevent cables and hoses from tangling.
- 5** For cables and hoses with different jacket materials, it is important to prevent them from "sticking" to one another. If necessary, they should be separated. igus® Chainflex® cables can be combined with all others.
- 6** Round electrical cables must be secured with strain relief at both ends. In exceptional cases, the cables may be fixed with strain relief at the moving end of the E-Chain® only. A gap of 10-30 x cable diameter between the end of the bending segment and the fixed point is recommended for most cables. Chainflex® cables can, on the other hand, be secured directly to the mounting bracket with strain relief (this has been confirmed with testing).

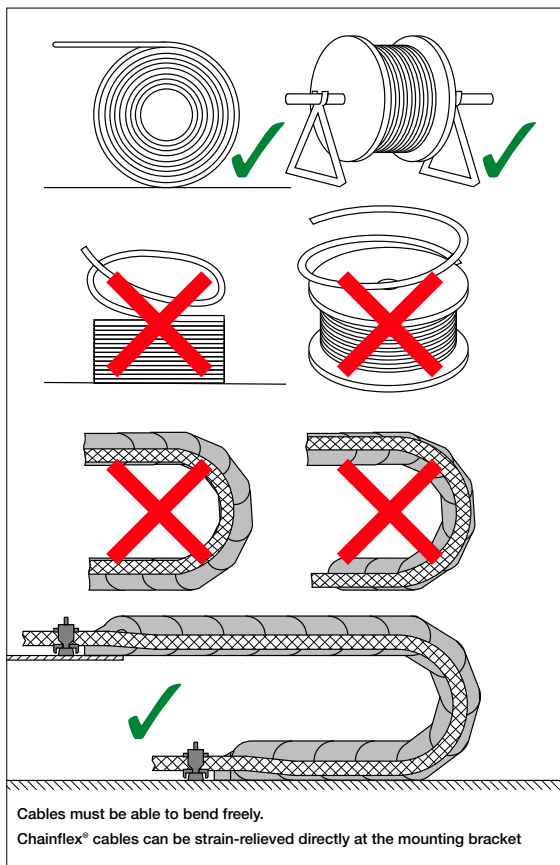

Pneumatic hoses

In principle, the same rules apply for pneumatic hoses as for round cables. In practice, it has been demonstrated that pneumatic hoses are less susceptible to wear. After consultation, they can be laid together more closely than the "10% clearance all-around" rule. A double-sided strain relief is required under these conditions. For pneumatic hoses made of rubber, we recommend strictly following the "10% clearance" rule because they tend to adhere to each other and to other conduits.



Fully pre-assembled E-ChainSystem® with several pneumatic hoses



The igus® program also offers polymer pneumatic hoses called: "Chainflex® Air"



Flat cables and pneumatic hoses installed in an E-Chain® with full interior separation

Flat cables

Flat cables must be able to move freely along the bending radius. Two flat cables next to one another should be kept apart with separators. If two flat cables are laid on top of one another, we strongly recommend the use of horizontal igus® shelving. Flat and round cables should be laid separately in the E-Chain®. Strain relief should be attached at both ends. Flat cables are only conditionally recommended for use in E-Chains®.

Flat cables - Outer jackets made of rubber must be specified particularly carefully, because of potentially high static friction.

Hydraulic hoses

When designing hydraulic hoses in E-Chains®, special attention should be paid to the expansion of the hoses when pressurized. Sufficient room must be left in the E-Chain® for this as well as the possible larger external diameter of the hoses under pressure. It is important for selected hoses to be sufficiently flexible (i.e. meet bending radius specified by the E-Chain®). The gliding ability and abrasion-resistant surface of the hoses are also important. All crossbars and shelves in the igus® E-Chain® minimize abrasion of hoses through wide, rounded and smooth surfaces. Normally, hoses with textile braiding are more flexible than hoses made of steel wire, while maintaining smaller outer diameters and better fatigue strength under reverse-travel stresses. As lateral movements of the hydraulic hoses within the E-Chain® can lead to increased abrasion of the hose material, they should be secured in position with vertical separators, but not forced. Special "locking" separators, which grip the opening crossbars of the chain, as well as the use of "spacers," prevent lateral shifting of the separators - they also ensure the hoses stay put in cases of strong vibration and impact on the chain.



igus® E-Chains® with hydraulic hoses in a tree-stripping machine



Hydraulic hoses need more space:
20% all-around clearance

Strain Relief - Hydraulic hoses are most often stretched lengthwise during operation. This must be taken into account when applying strain relief. More hose length is factored in to allow the hose to "breathe", or "floating" strain relief must be implemented. In some cases, one-sided strain relief on the moving end can be tolerated.

Rollclip - In almost all cases, the broad, smooth and rounded surfaces of all igus® E-Chains® are sufficient to protect hydraulic hoses from abrasion. In extreme cases, the igus® Rollclip can be installed. The hoses come in contact with a series of polymer cylinders which rotate. "Extreme" cases include particularly soft materials, particularly narrow bending radii or highly dynamic loads. Over 95% of all applications can be solved without Rollclips.



igus® Rollclip, detachable

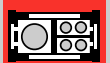
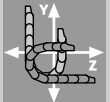



Ideally, the cables/hoses should be strain relieved at both ends of the E-Chain®. At the very least, they must be strain relieved at the moving end of the E-Chain®.

For more information on all igus® strain relief elements
▶ chapter 10

igus® E-ChainSystems®

Phone +49- (0) 22 03-96 49-800
Fax +49- (0) 22 03-96 49-222

igus® GmbH
51147 Cologne

Internet: www.igus.eu
E-mail: info@igus.de



Strain relief in KMA mounting bracket with C-profile

Strain relief for electrical cables

Strain relief can consist of standard elements or can be custom-made. For most applications, our standard program of C-profiles with mounting brackets and space-saving Chainfix clamps can be used. We also offer simple strain relief solutions using cable tiewraps and tiewrap plates. In ideal cases, the cables should be secured at both ends of the E-Chain® with strain relief (in a few instances, strain relief at the moving end of the E-Chain® is sufficient - please consult igus® for these cases).

Minimum gap of the strain relief and the beginning of the bending radius

Tests on our premises and in field applications have shown strain relief located at the last bending point of the E-Chain® has no influence over the durability of igus® Chainflex® cables. It is possible, therefore, to integrate the strain relief with the mounting bracket. This space-saving option for strain relief is offered by igus® for almost all E-Chains®.

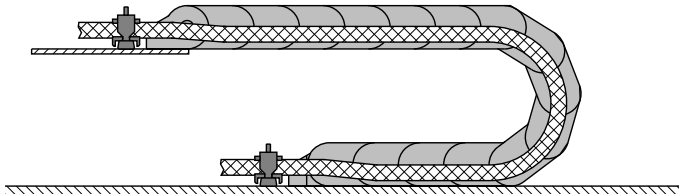

Ideal installation of cables in E-Chains®. Chainflex® cables can be directly strain-relieved in the mounting bracket (minimum gap to the last curved E-Chain® link is not necessary)!



Chainfix strain relief in mounting bracket in practice - used here for cables and hoses

Features of chainfix clamps

- Optimal igus® Chainfix housing with reduced height
- Long service life for dynamic applications thanks to improved clamping elements
- Integration with KMA mounting brackets - saves both time and space during installation and available for complete systems with cables and strain relief
- Improved housing foot clamp for easy fit into C-profile
- Black housing and setscrews for attractive appearance
- Setscrews, tightened with Allen wrench, for easy installation
- Mark of the installation direction
- Now with better fixation due to optimized design



Tiewrap plates as individual parts

- Separate parts in switch cabinet construction or machine assembly
- Strain relief accessory for igus® E-ChainSystems®
- Attachment to mounting brackets
- Integration into the C-profile of KMA (polymer/metal mounting brackets)



Tiewrap plates with clip-on connection for the C-profile

The plates **3050.ZC** and **3075.ZC** can be clipped directly into the C-profile without bolts or any extra hardware. Clip-on tiewrap plates can be released and repositioned with just a screwdriver used as a lever.



Chainfix clip - modular snap-on strain relief device

Chainfix clip is a series of clamps and bottom parts made of plastic for cable diameters ranging from 4 mm to 24 mm. Chainfix Clip is available for C-profiles, also suitable for assembly in the KMA mounting brackets and clip-on strain relief for cross bars

- Quick assembly without any tools
- 2 and 3 layers on top of one another possible
- Each layer can be detached and changed later on
- High tensile forces in case of single-layer installation, decreasing with the number of layers



Chainfix nugget - for top hat rail and C-profile

- **Option 1:** completely simple and universal cable fixation, for diameter with \varnothing 20 mm and \varnothing 30 mm
- **Option 2:** Fastening through clipping onto standard top hat rail
- The smart helper for electricians in the machine building industry
- Accessory for all KMA with integrated C-profile
- Strain relief for top hat rail
- Easy to assemble, without any screws and tools
- Adjustable to every E-Chain® filling
- Very small space requirement
- Easy strain relief due to fixation with pre-harnessed cable strap



Strainrelief separator

- Can be integrated in mounting bracket
- Strain-relief separator can be positioned as required
- Double strain relief possible
- Easy installation, cost-effective
- For Series E6,29, 2600/2700 (other Series upon request)



Design
Strain Relief

Phone +49- (0) 22 03-96 49-800
Fax +49- (0) 22 03-96 49-222

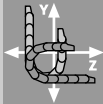



Technical environment:

- Fire resistance
- Radiation
- Weathering
- Cold, heat
- Explosion areas
- Vacuum
- Hot chips
- Dirt, dust
- Cleanroom
- Chemicals



igus® factory - automatic compounding and conveyor belt for igumid G

Technical environment and igumid G

The igumid G material, from which igus® E- Chains® are made, possesses the following wide-ranging features to cope with a variety of environments: the ability to handle pressure and strenuous loads, abrasion resistance, sturdiness, stable behavior at high and low temperatures, and suitability for outdoor use. Numerous application examples, from refrigerator blocks to steel mills, prove this. In extreme cases, we also offer modifications and other igus® compounds as a solution. Please consult igus®.

Resistance to radiation

igumid G is very resistant to high-energy radiation. Under gamma radiation, in the range of 8 x 10⁴ rd, the mechanical properties of igumid G change very little.

Flammability of igumid G

The flame-retardant characteristics of igumid G can be described using various classifications: Test procedure VDE 0304 parts 3-5.70 - classification 1lc. Tested according to UL 94 "Standard Tests for Flammability of Plastic Materials for Parts in Devices and Appliances" classification 94 HB for 3.2 and 1.6 mm thickness of the body. Tested according to DIN 4102 "Fire Behavior of Building Materials and Parts" classification materials class B-2. For further requirements, please consult igus® for special solutions, such as materials with self-extinguishing properties (UL V2 or UL V0). All E-Chains® (except for the Easy Chains® and Series 14) are made of from igumid G.



**igumid G has the classification UL 94 HB.
igumid NB has the classification
UL 94 V2. UL 94 V0 upon request**



**igumid G:
UL 94 HB**

**igumid NB:
UL 94 V2
UL 94 V0 (upon request)**



This robot is used for test purposes in British nuclear power plants

Flammability of igumid NB

All Easy Chains® and Series 14 Chains are made from the flame-retardant igumid NB material. These chains have the following flame-retardant classifications: ● UL 94 classification - V2 ● VDE 0304 Parts 3-5.70 classification - 1lb ● DIN 4102 flammability of materials - B2 ● Please consult igus® regarding material availability "V0"



igumid G:

- UV-resistant
- Temperature range from: -40°C (40°F) to +120°C (248°F)

Temperature resistance

igumid G is very suitable for outdoor applications. In our experience, the mechanical properties of the E-Chain® are not impaired. igumid G is also UV-resistant. igus® E-Chains® are used in applications as cold as -40°C (40°F). Installation may be eventually compromised at temperatures below -25°C (-13°F). In such cases, we offer special solutions made from cold-elastic materials. 120°C (248°F) continuous temperatures are possible. However, the mechanical values are reduced and the service life is impaired.



Live broadcast from the Winter Olympics in Lillehammer - 75 m travel at -25°C (-13°F)



ESD & ATEX

Special ESD products and ESD tools must be used in numerous industrial sectors in order to protect sensitive electronic components against electrostatic discharge. Consequently an electrostatic discharge function applies in particular to energy ducting systems with their central role in automated sequences. igus® has developed the ESD E-Chain® for these demanding applications. They are made of material igumid ESD which immediately discharges



More ESD and ATEX information:
www.igus.eu/atesx



The hue of igumid ESD approximately corresponds to RAL 7015 slate-gray

permanent electrostatic charges in controlled manner. igumid ESD consists of the igus® E-Chain® material which has been tried and tested for over 35 years now in millions of applications with special additives. These additives provide the required properties and, in **mechanical** requirements, even exceed the standard material. Thus, for instance, the somewhat higher rigidity and the approx. 15% lower density can be used to implement a longer unsupported length, depending on application. The ESD E-Chain® features an even longer service life owing to the material. Unlike temporarily acting, applied conductive coatings or volatile, incorporated antistatics, the additives used provide durable and "maintenance-free" conductivity. One other advantage is the resistance to adverse ambient conditions.



igumid ESD with PTB certificate - We have received an official comment from the German National Standards Laboratory (PTB) on material igumid ESD and we are able to provide you with a copy on request

System E6 - 2nd Generation ESD Chains without pin and bores, long-term conductivity guaranteed

For many years, safety in hazardous areas and ESD protection in sensitive production areas have been given high priority at igus®. Since 1992, E-Chains® have been manufactured from our special "GC" material. Certified since 1994 by PTB (German federal office for Physics and Technology), the material was modified in 2002. In spite of homogeneous conductivity of the material, common pin/bore design chains can hardly maintain their conductivity within normed conductivity tolerances in the long term.

- Constant long term conductivity values
- No contact surface wear
- Proven standard product, now also conductive
- Cycle life in lab test ≥10 Million cycles (more upon request)
- Underlies heightened QC procedures, with and without mounting brackets and in various install modes
- IPA Fraunhofer institute certifies "Level 1" discharge performance, acc. to SEMI E78-0998 ESD, even for off-the-shelf standard E6 material.

Design
Technical Environment

Phone +49- (0) 22 03-96 49-800
Fax +49- (0) 22 03-96 49-222

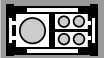
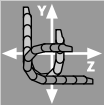

igus® goes clean room - qualification of E6 and other igus® E-Chains®

In many applications where cumbersome special solutions are used, a simple standard E-Chain® can be used instead. A comprehensive test program was devised and performed for both gliding use and unsupported use. For many applications, the E-Chains® in special materials are practically abrasion-free. Detailed test results are available upon request. IPA tests confirm that standard igus® E-Chains® meet clean room requirements. "Tested and certified as very good!" E-Chains® for clean room applications on the test stand Clean room environments demand very high wear resistance of moving parts. E-Chains®, for example, must be very wear resistant, in order to meet norm requirements for such a sensitive environment.

IPA Fraunhofer Institute has tested igus® Series E3, E6 and Easy Chain® as follows:

- ISO class 1, as per stringent norm DIN EN ISO 14644-1 for System E3, Series E3.15.040.075.0 at v = 0,5 m/s, 1 m/s, 2 m/s
- ISO class 1, as per stringent norm DIN EN ISO 14644-1 for System E6 - special material*, Series E6.29.060.150.0.CR at v = 0,5 m/s, 2 m/s
- ISO class 3, as per stringent norm DIN EN ISO 14644-1 for System E6 - standard material, Series E6.29.060.150.0 at v = 0,5 m/s, 1 m/s, 2 m/s
- ISO class 2, as per stringent norm DIN EN ISO 14644-1 for Series Easy Chain® E14.3.038 at v = 1 m/s

Phone +49- (0) 22 03-96 49-800
Fax +49- (0) 22 03-96 49-222

Test setup: Particle generation measurement



Measurement result: Particle generation E14.3.038.0

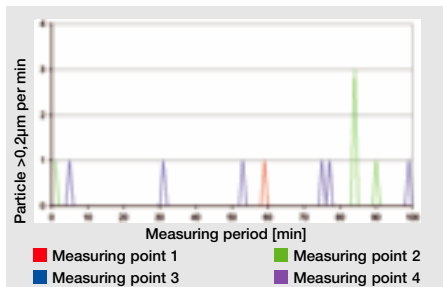

ISO Class 2

acc. to DIN EN ISO 14644-1
for E14.3.038.0

Test setup: Field strength measurement



Measurement result: Field strength E6.29.050.055.0

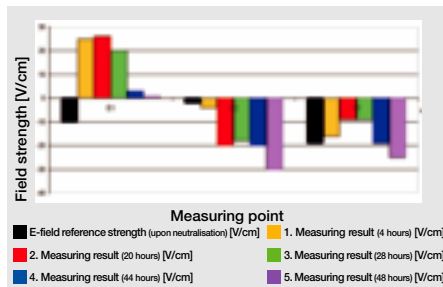

Level 1

ESD-compatibility acc. to SEMI E78-0998
for E14.3.038.0 and E6.29.050.055.0

igus® GmbH
51147 Cologne

Classification chart

Class per DIN	Equivalent to	Equivalent to	Classification	Speed
EN ISO 14644-1	VDI 2083	US Fed.Std. 209E	Series	[m/s]
ISO class 1	no comparable classification	no comparable classification	E3.15.040.075.0	0,5 / 1,0 / 2,0
ISO class 1	no comparable classification	no comparable classification	E6.29.060.150.0.CR*	0,5 / 2,0
ISO class 2	no comparable classification	no comparable classification	E14.3.038.0	1,0
ISO class 3	class 1	class 1	E6.29.060.150.0	0,5 / 1,0 / 2,0
ISO class 4	class 2	class 10		
ISO class 5	class 3	class 100		
ISO class 6	class 4	class 1.000		
ISO class 7	class 5	class 10.000		
ISO class 8	class 6	class 100.000		

*special material "clean room"

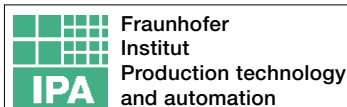

Internet: www.igus.eu
E-mail: info@igus.de

Splatter, hot chips

Laboratory tests and numerous field applications prove that igus® E-Chains® and E-Tubes reliably protect cables in welding robots and machine tools since 20 years. E-Tubes made from the igus® igumid HT material are resistant against burnt-in chips up to 850°C (1,562°F), no chips do stick. This opens new possibilities for replacing difficult-to-handle steel tubes. Program range: All standard E2 and E4 E-Tube sizes, upon request. Please note: igumid G in direct contact with large amounts of melted aluminum is not recommended.



E-Tubes that repel hot chips, up to 850 °C with the igus® "igumid HT" material.

Further Information ► www.igus.de/en/HT

Dirt, dust, chips

Materials and design make igus® E-Chains® excellent problem-solvers in harsh environments. Experience and application references are available upon request. Please consult igus® with your application.

Vacuum

igus® E-Chains® made of igumid G can be used in vacuum applications. Very little outgassing occurs.

Chemical resistance

igumid G is resistant to fuel, lubricants, oils, fats, alcohol, ester, ketone, and aliphatic and aromatic hydrocarbons. Oxidants and acids are damaging. The table ► **page 1.39** shows an excerpt of the precise details concerning resistance to chemicals. Acid-resistant E-Chains® are available upon request.



igus® E-Tubes in the chip area of machine tools

Coolant resistance

E-Chains® and E-Tubes have proven **resistant to cooling agents**. However, we are always willing to perform individual tests if you have particular problems or advanced developments. **Table on resistance to chemicals** ► **page 1.39**.



Also hot asphalt is no problem for igus® E-Tubes, Series R48



Compost sludge - numerous related references available upon request



igus® - Experience with

Dust, dirt, mud, compost, wood, textile fibers, paper dust, abrasive paste, cooling agents, glass sand, glass splinters, coal dust, sand, corundum and much more.



Particularly suitable E-Chain® Series for dirt, dust, chips

- E4/4HD ► chapter 7
- System E4 ► chapter 7
- E2 E-Tubes ► chapter 6
- E2/000 ► chapter 5

Design
Technical Environment

Phone +49- (0) 22 03-96 49-800
Fax +49- (0) 22 03-96 49-222

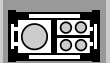
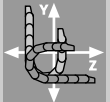

Plastics for longer life® - igus® know-how in polymer materials

Each year, igus® engineers develop more than one hundred new plastic compounds and test igus®-products in more than 5,000 experiments per year. That's how in recent years they have built an extensive database of the tribological properties of polymers. This database makes it possible for us to assess better most of the applications in advance and provide our customer with confidence during use. Our calculations and analyses are based on the result of ongoing practical tests in our Technical Center and our experience with gliding applications. The focal points of our tests are push-pull forces, friction values and abrasion under widely varying conditions and speeds, as well as factors such as dirt, weathering or impact and bumps. We test all system components such as cables, hoses, strain relief and other accessories, in addition to the E-Chains® or E-Tubes and Guide Troughs.



Material data igumid

Material data table	Units of Measure	Values igumid G	Values igumid NB	Values igumid ESD	Values igumid TE
Yield stress	MPa	190/130	78/40	-	-
Elongation at break	%	004/006	20/210	-	-
Elasticity module (tensile test)	MPa	9000/7000	2900/1200	-	-
Impact strength +23°C	kJ/m²	55/65/55	not broken	-	-
Impact strength -40°C	kJ/m²	40	90	-	-
Ball indentation hardness H 961/30	MPa	230/160	150/60	-	-
Heat conductivity W/k * m	Ω/k * m	0,23	-	-	-
Dielectric constant	10³ Hz	3,9/6,2	-	-	-
special transitional resistance	Ω*cm	>10¹¹	>10¹¹	<10⁹	-
Impact strength density 0,6-0,8 mm	kV/mm	80	16-18	-	-
Surface resistance ROA	Ω	>10¹¹	>10¹¹	<10⁹	-
Density	g/cm³	1,37	1,14	1,2	1,02
Absorption of humidity 23/50 RF	%	1,4	3,4	1,9	1,1
Coefficient of sliding friction	-	0,3	0,3	0,3	0,3
Fire resistance as per VDE	-	FH2	-	-	-
Fire resistance as per UL	-	HB	V-2	HB	HB
Color	-	■ = RAL 9004	■ = RAL 9004	■ = RAL 7015	■ = RAL 9004
Maximum water absorption	-	5,6	7,6	7,3	-
Limit of elasticity in bending	MPa	7.800	3.000	9.500	-
Bending strength	MPa	240	120	230	-
Hardness Shore D	-	79	79	83	-
Upper long-term application temp.	-	120°C (248°F)	80°C (176°F)	80°C (176°F)	70°C (158°F)
Upper short-term application temp.	-	180°C (356°F)	170°C (338°F)	150°C (302°F)	140°C (284°F)
Lower application temp.	-	-40°C (-40°F)	-40°C (-40°F)	-40°C (-40°F)	-40°C (-40°F)

Medium	Concentration Weight %	Material igumid G /NB
Acetone	100	+
Formic acid (aqueous)	2	○
Ammonia (aqueous)	10	+
Gasoline	100	+
Benzole	100	+
Bitumen	100	○
Boric acid (aqueous)	10	+
Butyric acid	100	○
Calcium chloride (aqueous)	Sat. aq. sol.	+
Chlorinated hydrocarbons		+
Chlorine water	Sat. aq. sol.	-
Chromic acid (aqueous)	1	○
Diesel oil	100	+
Iron II cyanide	30	○
Acetic acid	2	+
Color		+
Fats, cooking		+
Fluorinated hydrocarbons		+
Formaldehyde (aqueous)	30	○
Hydraulic oils		+
Caustic potash	10	+

Resistance classes

- + = resistant
- = conditionally resistant
- = non-resistant

Medium	Concentration Weight %	Material igumid G /NB
Potassium carbonate (aqueous)	60	+
Potassium sulphate (aqueous)	100	+
Methyl acetate	100	+
Milk		+
Mineral oil		+
Sodium carbonate (aqueous)	50	+
Oil, cooking		+
Oil, lubricating oil		+
Oleic acid	100	+
Paraffin oil		+
Perchloroethylene	100	+
Polyester resins (with styrene)		+
Propane gas		+
Mercury		+
Hydrochloric acid	pH2	○
Hydrochloric acid	2	-
Hydrochloric acid	10	-
Ink, printing ink		+
Vaseline		+
Tartaric acid		○
Zinc sulfate (aqueous)	10	+

Sat. aq. sol. = saturated aqueous solution

Conc. aq. sol. = concentrated aqueous solution

The values specified are values determined by laboratory tests and are material-specific. All specifications apply to black E-Chains®.

Colors and special solutions

All E-Chains® made from igumid G are available in the colors listed below. Additional colors are usually feasible. Colored E-Chains® are basically not available from stock. Contact igus® for more information regarding colored E-Chains®. All values listed apply to stability (e.g. unsupported lengths) and material characteristics for black E-Chains® only. Colored E-Chains® may have altered characteristics. This also applies for all E-Chains® made from special materials (e.g. conductive E-Chains® made from igumid GC or other special materials).

"RAL" Numbers

	Black	= RAL 9004	Index .0
	White	= RAL 9003	Index .1
	Violet	= RAL 4008	Index .5
	Yellow	= RAL 1018	Index .4
	Orange	= RAL 2003	Index .2
	Red	= RAL 3002	Index .6
	Blue	= RAL 5005	Index .8
	Green	= RAL 6011	Index .7
	Grey	= RAL 7023	Index .3 for Chains
	Dusty grey	= RAL 7037	Index .3 for Tubes
	Agate grey	= RAL 7038	Index .11
	Light grey	= RAL 7035	Index .14
	Black grey	= RAL 7021	Index .13
	Slate grey	= RAL 7015	only ESD-E-Chain®
	Yellow/black	-	Index .9



Colors for design coding

Standards and Certificates
Material Data igumid & Colors

Phone +49- (0) 22 03-96 49-800
Fax +49- (0) 22 03-96 49-222

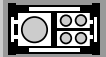
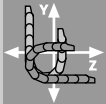



Quality inspection of every E-Chain® production



Test location for ESD-E-Chains®



Chainflex® cables with many certificates for e.g. DESINA



Noise level tests in igus® own acoustic laboratory

Examples for test certificates and approvals

ISO 9001

igus® has been certified since November 1996

TÜV construction test

igus® E-Chains® and E-Tubes are construction-tested by TÜV Rheinland. igus® E-Chains® were tested and passed by TÜV Rheinland in accordance with the valid machine guidelines. As a result, the user of igus® E-Chains® need not worry about meeting CE requirements through testing for this portion of the machinery. **The construction test 2PFG 1036 / 10/97 for protective equipment includes the following:**

- Application and safety
- Assembly
- Fatigue strength
- Resistance to external influences
- Sharp corners and edges

ESD/ATEX

igus® E-Chains® made of standard material igumid G correspond to the German federal office of Physics and Technology (PTB) to classification Ex II 3 GD according to ATEX-RL 94/9/EG. igus® E-Chains® made of igumid ESD correspond according to the German federal office of Physics and Technology (PTB) to classification Ex II 2 GD according ATEX-RL 94/9/EG.

IPA Cleanroom

A lot of E-Chains® are suitable for the use in cleanrooms according to DIN EN ISO 14644-1. Confirmed by the IPA Fraunhofer Institute.

UL, CSA, CEI, CE and VDE

All igumid-materials for E-Chains® and E-Tubes have got the UL-material approval. The material igumid NB has got the fire protection class approval IIb according to the test VDE 0304 Part 3/5.70, the approval V2 according UL 94 and the construction material class B2 according DIN 4102.

Interbus, CC-Link and DESINA

Chainflex®- cables are produced according to a lot of international standards: **Interbus certification:** For Interbus certification of certain CF11 bus cables. **CC-Link:** with CC-Link approval. **DESINA:** Many Chainflex® cables are Desina-compliant.

Clearly quieter

igus® E-ChainSystems® are clearly quieter. In the acoustic laboratory of the TÜV and the igus® GmbH different E-Chains® were compared. The igus® Systems E3, E6 and E4/00 (Series E4/101) are measurably (and clearly) quieter than other products of comparable size (see also noise-optimized E-Chains® ► [page 1.11](#))

igumid

The material igumid is free from toxins, according 2002/95/EC (RoHS).

iF Design Award

16 iF Design-Awards since 1984



ReadyChain[®]

Plug and play E-ChainSystems[®]

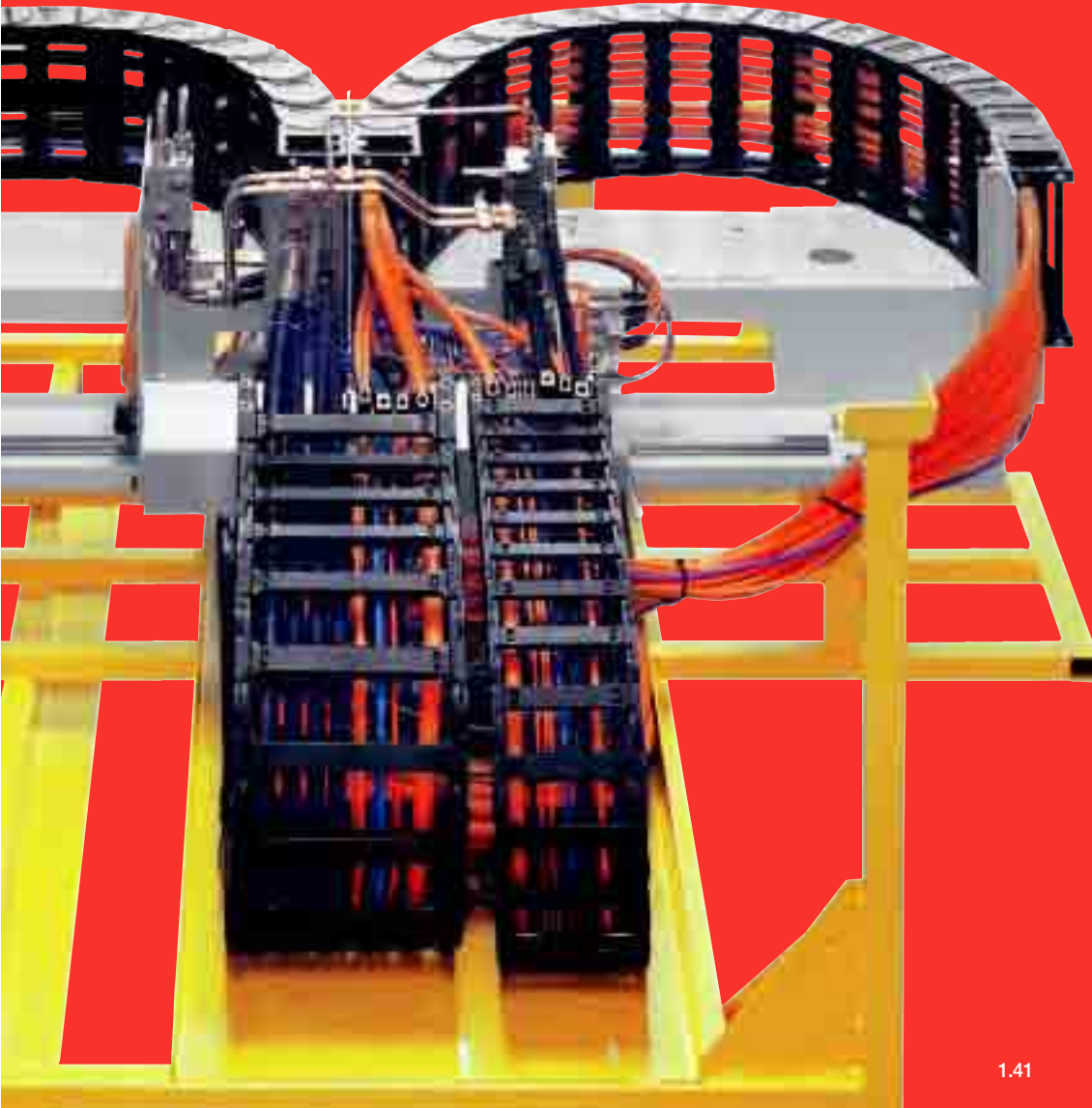

The advantages of plug and play E-ChainSystems® from igus®

- Increase your cash-flow
- Cover the fluctuations
- Reduce your throughput
- Minimize downtime
- Reduce number of purchase orders by about 75%
- Zero stock
- Modern equipment means low cost at highest quality
- Any system is checked in our test center
- More than 3,000 electrical components from stock
- Delivery with individual Plates and mounting parts
- igus® is certified according to DIN EN ISO 9001:2000
- ReadyChain®-factory with more than 80 experts
- Over 700 systems leave the 10 ReadyChain® factories worldwide every week
- Profit from our long experience acquired since 1993
- Worldwide service in more than 45 countries

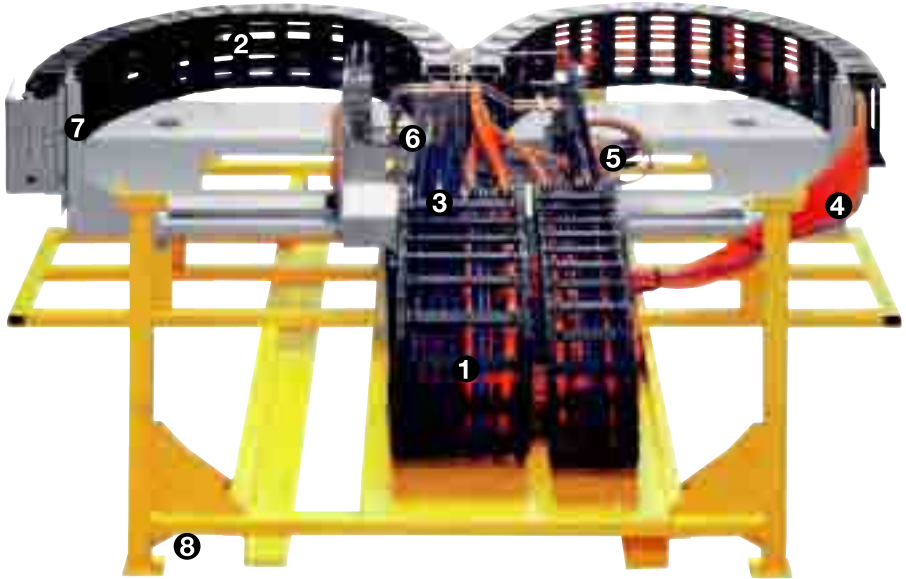

- | | |
|--------------------------------------------------------------------------------------------------------------------------------------------------------------------------------------------------------------------------------------------------------------------------------------------------------------------------|--------------------------------------------------------------------------------------------------------------------------------------------------------------------------------------------------------------------------------------------------------------------------------------------------------------------------------------------|
| <p>1 Ordered cables and hoses within the E-Chain® using separators and shelves from igus®</p> <p>2 E-Chain®, specially designed for your machine</p> <p>3 Strain relief systems, specially designed for use in your machine</p> <p>4 Special cables and hoses, designed for E-Chains® and suited to your application</p> | <p>5 Connector components, preassembled according to specification standards of Siemens, Fanuc, SEW, etc.</p> <p>6 Hydraulic components, designed for your application</p> <p>7 Plates and mounting parts, optimized for the quick installation on your machine. Delivered ready to install.</p> <p>8 Installation and transport racks</p> |
|--------------------------------------------------------------------------------------------------------------------------------------------------------------------------------------------------------------------------------------------------------------------------------------------------------------------------|--------------------------------------------------------------------------------------------------------------------------------------------------------------------------------------------------------------------------------------------------------------------------------------------------------------------------------------------|

igus® ReadyChains® increase your cash-flow

Whether major projects or simple, assembled E-Chains® - we save you costs, time and hassle through igus® ReadyChains®. Over 700 systems leave the 10 ReadyChain® factories worldwide every week. Profit from our long experience acquired since 1993, and increase your cash flow quickly and smoothly even for one-off systems.

- 1 Zero stock of cables, E-Chains® and connectors** - Forget storage of flexible cables, connectors and other parts with our fast delivery times. **Detailed information ► page 1.44**
- 2 Reduce throughput time by about 50%** - igus® delivers ready-made systems worldwide within 2-8 days of the guaranteed date. **Detailed information ► page 1.45**
- 3 Respond flexibly to order fluctuation** - With ReadyChains® you are always prepared for variations in demand. We help cover the fluctuations. **Detailed information ► page 1.46**
- 4 Minimize downtime** - Small things can cause big problems. Buying numerous single parts increases your inventory and the chances of problems. You will get a system solution with ReadyChains®. Any system is checked in our test center. igus® is certified according to ISO 9001. **Detailed information ► page 1.47**
- 5 Reduce number of suppliers and purchase orders by about 75%** - One order one invoice one delivery one partner. Don't care about looking for numerous parts from numerous suppliers. We have the knowledge to provide you quickly with the optimal parts. **Detailed information ► page 1.48**

You determine the degree of harnessing

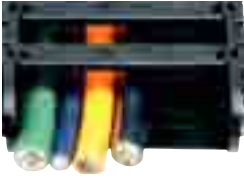

Any degree is possible

We harness from simple E-ChainSystems® with pre-fitted Chainflex® cables to complex systems. These systems may include all cables and hoses (pneumatic, hydraulic), patch plugs, inner partitions, connecting elements and connecting parts as required.



From easy to project

You determine the size



Any size is possible

Because of our upto-date production processes we can deliver fast and cost effective custom build or serial production products.



From one-off to serial production

You determine the travel length



Choose the travel length

ReadyChains® offers the whole spectrum of possible travels of the igus® E-Chains®. We harness anything from short to long travels. Safe transportation guarantees damage-free delivery of any lengths.



From short to long

Standardised ReadyChain®: Ready to fit



ReadyChain® "Basic"

Simple, prefabricated E-ChainSystem® including assembled cables without connectors, labelled and according to your specifications.



ReadyChain® "Standard"

Simple, prefabricated E-ChainSystem® including assembled cables with all connectors, labelled according to your specifications.



ReadyChain® "Premium"

A prefabricated E-ChainSystem® with cables of all kinds, as well as plugs, connectors and components. Special shafts and plain bearings machined according to your specifications.



1 Reduces your storage costs to zero for cables, E-Chains® and connectors

In Cologne, igus® manufactures its products on about 25,000 m² interior space. 80,000 products delivered off the shelf. Reduce your capital commitment and increase your cash flow with igus®ReadyChain®. Our large-volume material procurement saves you time and money, independent of serial application or individual projects. The complete component ReadyChain® reduces your storage and dispatching of E-Chains®, cables and plug connectors to a minimum, and at the same time reduces the number of your suppliers and orders by 75%. Make use of the experience of over 90 igus® ReadyChain® specialists in your own interest.



More than 70,000 E-Chain® components...

Phone +49- (0) 22 03-96 49-800
Fax +49- (0) 22 03-96 49-222



...more than 3,000 electrical components...

igus® GmbH
51147 Cologne



...more than 850 Chainflex® special cables...

Internet: www.igus.eu
E-mail: info@igus.de



...in the huge igus® cable store.

2 Cut your throughput times from days to hours

The throughput time of the assembly of complete E-ChainSystems® often takes several days. Reduce the throughput times to hours - with ReadyChain® from igus®.

ReadyChains® - Ready to fix and install

The delivery condition of your ReadyChain® is crucial for your in-house transport and installation. To bring the material into motion is one of our most important tasks for your operation. Experienced specialists from the igus® ReadyChain® project planning division would be glad to advise you in the definition of the component interfaces and on the design of the combined transport and installation aids.



Machining center - System E4/light, Chainflex® cables, mounting plates and igus® strain relief systems delivered ready to install



Racks for transport to and within your company



Large batch sizes for serial production



Installation-optimized delivery of an igus® ReadyChain®



ReadyChain® "from the roll". We supply your ReadyChain® for long travels on special cable reels



Defined picking order for your time-phased production



igus® ReadyChain® on mounting frames for lightning fast final assembly



3 Respond flexibly to order fluctuations

Utilize igus® manufacturing capacities

Transfer your capacity problems to us. The igus® ReadyChain® factory compensates for your order fluctuations with state-of-the-art production technology and specialized staff.

Respond flexibly and utilize our know-how

Flexible production planning Customers are guaranteed consistent quality at low costs. All employees are trained both for the ReadyChain® installation and for the cable assembly. Flexible production planning safeguards your delivery times



igus® ReadyChain®-factory: 80 experts
produce more than 700 systems per week



Special departments take
care of your individual project



Automatic crimp machines guarantee
safe connections, rationally connected



The automatic cable stripping facility
allows cheap prices for highest quality



ReadyChain® large projects - Specially trained
employees accompany your project from start to finish



Cable handling
and measurement



Precision at every igus® workplace.
For batch applications and one-off projects

4 Minimize your machine downtimes

All components of the ReadyChain® undergo an extensive quality control and functional tests

Our quality assurance division subjects every ReadyChain® system to functional tests with special testing facilities before they are dispatched. All ReadyChain® systems and components are tested in the igus® laboratory. Over 2,000 tests are conducted with E-ChainSystems® and cables every year. With an igus® system guarantee (according to application), we offer assurance on the safety and quality of your ReadyChain®. igus® is certified according to DIN EN ISO 9001:2000



Component test - tensile strength and shear force test of igus® E-Chain®. $v = 10 \text{ m/s}$, $a = 200 \text{ m/s}^2$



Computer-aided, high-voltage test equipment ensure tested quality



Test adapter for the testing of any ReadyCable®



igus® climate chamber - E-Chain® and Chainflex® test runs possible at -40° (-40°F) to $+60^\circ\text{C}$ (140°F)



Component test - torsion tests for cables



All tests are logged and electronically stored



Quality from the beginning with high-tech machines



5 Reduce the number of supplier and orders by 75%

One order - One invoice - One delivery - One partner

Reduce your planning costs. We relieve you of as much work as possible. Our trained staff will step by step support a smooth development of your ReadyChain® project. We can demonstrate all advantages of ReadyChain® for your business. We will visit your site discuss the application and and collect all required data for your ReadyChain® project



igus® staff at the "on-site inspection" of a plant



Planning with special software tools



Drawing up detailed design worksheets



We can submit a complex offer within a week

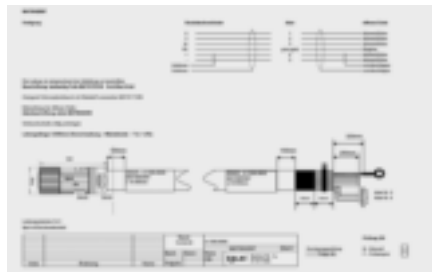

Precise job and grouping of cables planning for each cable



Pre-harnessed E-Tube for machining centers.
E-Tube protect cables against dirt and chips



On-site assembly of an igus® ReadyChain®. igus® delivery scope includes machine parts, saving time and money



Horizontal machining center - harnessed with igus® E-ChainSystem® E4/4, Chainflex® cables and accessories



Machining center - System E4/light E-Chains®, Chainflex®-cables, metal parts and igus® strain relief



Flexible response to order fluctuations:
Have the complete subassembly built at igus®



Tool magazine - igus® E2/000 E-Chain® harnessed with Chainflex® CF27, CF11 and CF.INI cables



ReadyChains®, connected through a junction box, delivered by igus®, make installation even easier



Harnessed igus® E4 E-Chains® on an X/Y unit in the textile industry with high cycle counts

