

1. iglidur®



.plastics

The right plain bearing for your application

**Low cost
all rounder**



iglidur® G
The universal bearing with a wide range.

► Page 2.1
www.igus.de/en/g

iglidur® J
Low friction values in dry running. Best performance with soft shafts.

► Page 3.1
www.igus.de/en/j

**High
temperature**



iglidur® X
Temperature resistant from -100°C to 250°C, universal resistance to chemicals.

► Page 6.1
www.igus.de/en/x

iglidur® Z
The high temperature material for extreme loads and temperatures.

► Page 22.1
www.igus.de/en/z

**Low
friction**



iglidur® J
Low friction values with many different shafts, lowest possible friction value against V4A.

► Page 3.1
www.igus.de/en/j

iglidur® Z
When low friction values and high temperatures are called for simultaneously.

► Page 22.1
www.igus.de/en/z

**For high loads
up to 150 MPa**



iglidur® X
Temperature resistant from -100°C to 250°C, universal resistance to chemicals.

► Page 6.1
www.igus.de/en/x

iglidur® Z
For very high loads and speeds.

► Page 22.1
www.igus.de/en/z

**Resistant
to chemicals**



iglidur® X
Temperature resistant from -100°C to 250°C, universal resistance to chemicals.

► Page 6.1
www.igus.de/en/x

iglidur® A500
Complies with the requirements of the FDA. Similar to iglidur® X, but suitable for direct contact with foodstuffs.

► Page 10.1
www.igus.de/en/a500

**Operation
under water**



iglidur® UW
For fast rotational speeds under water (e.g. pumps) at low radial loads.

► Page 20.1
www.igus.de/en/uw

iglidur® H370
For underwater operation at low speeds, use up to 200°C possible.

► Page 15.1
www.igus.de/en/h370

**Compatible
with foodstuffs**



iglidur® A180
Comply with the requirements of the FDA for repeated contact with food. For low and medium loads. Perfect for a wet environment.

► Page 7.1
www.igus.de/en/a180

iglidur® A200
Comply with the requirements of the FDA for repeated contact with food. For low and medium loads.

► Page 8.1
www.igus.de/en/a200

**Low
Cost**



iglidur® GLW
Low cost in high quantities. For high loads.

► Page 26.1
www.igus.de/en/glw

iglidur® R
Exceptionally low cost plain bearings with low friction value.

► Page 19.1
www.igus.de/en/r



iglidur® M250

Thick-walled, robust, vibration dampening, resistant to dirt.

► Page 4.1
www.igus.de/en/m250

iglidur® W300

For exceptional service life, also suitable for soft shafts.

► Page 5.1
www.igus.de/en/w300

iglidur® P

High precision in damp and warm conditions.

► Page 17.1
www.igus.de/en/p

iglidur® V400

Extreme wear resistance with soft shafts, very elastic.

► Page 21.1
www.igus.de/en/v400

iglidur® A500

Complies with the requirements of the FDA. Up to 250°C with special suitability for food contact.

► Page 10.1
www.igus.de/en/a500

iglidur® H4

Temperature resistant for under bonnet applications, low cost and versatile.

► Page 14.1
www.igus.de/en/h4

iglidur® L250

Excellent friction values at high rotational speeds and low load, recommended for V2A.

► Page 16.1
www.igus.de/en/l250

iglidur® Q

Cost effective plain bearings with excellent resistance to high loads.

► Page 18.1
www.igus.de/en/q

iglidur® H1

High resistance against chemicals, extreme wear resistant, even with smooth shafts.

► Page 13.1
www.igus.de/en/h1

iglidur® Q

Cost effective plain bearings with excellent resistance to high loads.

► Page 18.1
www.igus.de/en/q

iglidur® F

For extremely high loads and pressure. Electrically conductive.

► Page 11.1
www.igus.de/en/f

iglidur® H1

High resistance against chemicals, extreme wear resistant, even with smooth shafts.

► Page 13.1
www.igus.de/en/h1

iglidur® V400

High chemical resistance, very high wear resistance even in contact with soft shafts.

► Page 21.1
www.igus.de/en/v400

iglidur® Z

The high temperature material for extreme loads, temperatures, pressures.

► Page 22.1
www.igus.de/en/z

iglidur® H

For underwater operation, applications up to 200°C, good chemical resistance.

► Page 12.1
www.igus.de/en/h

iglidur® A290

The material complies with the requirements of the BfR. Plain bearings with high mechanical resistance. Temperatures up to 140°C.

► Page 9.1
www.igus.de/en/a290

iglidur® A500

Complies with the requirements of the FDA. Highest chemical resistance, no water absorption and temperatures up to 250°C.

► Page 10.1
www.igus.de/en/a500

iglidur® – Detailed Table of Contents

Design Engineering with iglidur®

Selection Guides

▶ P. 1.8

High performance polymer plain bearings

▶ P. 1.16

Properties of iglidur® Bearings

▶ P. 1.17

The Self-Lubricating Effect

▶ P. 1.18

Compressive Strength

▶ P. 1.20

Surface Speed

▶ P. 1.22

p x v value

▶ P. 1.24

Lubrication

▶ P. 1.24

Temperatures

▶ P. 1.25

Coefficient of Thermal Expansion

▶ P. 1.26

Coefficients of Friction

▶ P. 1.26

Wear Resistance

▶ P. 1.28

Shaft Materials

▶ P. 1.30

Chemical Resistance

▶ P. 1.32

Food industry applications

▶ P. 1.33

Radioactive Radiation

▶ P. 1.33

UV Resistance

▶ P. 1.33

Vacuum

▶ P. 1.34

Electrical Properties

▶ P. 1.34

Tolerances and Measurement

▶ P. 1.34

System

▶ P. 1.34

Testing Methods

▶ P. 1.35

Troubleshooting

▶ P. 1.35

Machining

▶ P. 1.36

Installation

▶ P. 1.37

Adhesion

▶ P. 1.37

iglidur® – Standards for All Cases, from Stock



iglidur® G

The All-Round Performer

▶ Page 2.1

- Maintenance-free dry running
- High wear resistance
- More than 900 sizes available from stock



from stock



iglidur® J

The Fast and Slow Motion Specialist

▶ Page 3.1

- Low wear against different shaft materials
- Low coefficients of friction in dry run
- Best performance with soft shaft materials

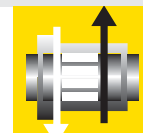

from stock



iglidur® M250

Thick and Robust

▶ Page 4.1

- Excellent vibration dampening
- Resistant to edge loading
- High impact resistance



from stock



iglidur® W300

The Marathon Runner

▶ Page 5.1

- For especially long service life
- Low coefficient of friction
- Also suitable for soft shafts



from stock



iglidur® X

The High-Tech Problem Solver

▶ Page 6.1

- Temperature resistant from -100°C up to 250°C
- Universal resistance to chemicals
- Very low moisture absorption



from stock

iglidur® – Special Materials, from Stock



iglidur® A180

Very Appetising

▶ Page 7.1

- Complies with the regulations of the FOOD AND DRUG ADMINISTRATION
- for wet Environments



from stock



iglidur® A200

Very Appetising

▶ Page 8.1

- Complies with the regulations of the FOOD AND DRUG ADMINISTRATION
- for low speeds

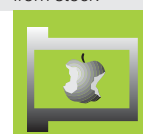

from stock



iglidur® A290

Very Appetising

▶ Page 9.1

- Suitable for direct contact with food and pharmaceuticals
- Physiologically safe



from stock



iglidur® A500

Food Applications

▶ Page 10.1

- Complies with FOOD AND DRUG ADMINISTRATION regulations
- Temperature resistant from -100°C up to +250°C

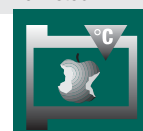

from stock

iglidur® – Special Materials, from Stock



iglidur® F

The Lightning Conductor

► Page 11.1

- Electrically conductive
- High compressive strength
- High temperature resistance



from stock



iglidur® H

For Wet Environments

► Page 12.1

- Suitable for underwater applications
- For high temperatures
- Good chemical resistance



from stock



iglidur® H1

The endurance runner at high temperatures

► Page 13.1

- High wear resistance at high temperatures
- Extremely low coefficients of friction
- For underbonnet applications

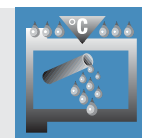

from stock



iglidur® H4

For Under Bonnet Applications

► Page 14.1

- Good abrasion resistance
- Low coefficients of friction
- High temperature resistance
from -40°C up to +200°C

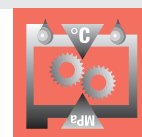

from stock



iglidur® H370

The Underwater Specialist

► Page 15.1

- Excellent for underwater applications
- Wear-resistant
- Good chemical resistance

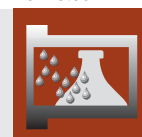

from stock



iglidur® L250

For Fast Rotations

► Page 16.1

- Recommended for rotating applications
- Very low coefficients of friction
- Excellent wear resistance



from stock



iglidur® P

Cost-Effective and Maintenance-Free

► Page 17.1

- Low water absorption
- Low wear rates
- Cost-effective



from stock



iglidur® Q

Fit for High Loads

► Page 18.1

- Excellent wear resistance at high loads
- Recommended for extreme p x v values
- Maintenance-free dry running

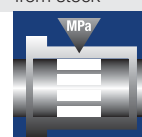

from stock



iglidur® R

Low Friction, Low Cost

► Page 19.1

- Low friction value
- Very low cost

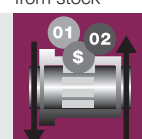

from stock



iglidur® UW

The Underwater Specialist

► Page 20.1

- For underwater applications
- For fast and constant movements

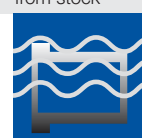

from stock



iglidur® V400

Wear-Resistant at High Temperatures

► Page 21.1

- Extreme wear resistance
with soft shaft materials
- Good chemical resistance
- High elasticity

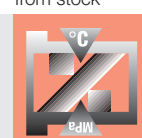

from stock

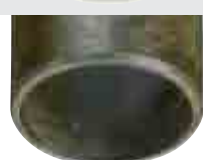

iglidur® Z

The High Temperature Material

► Page 22.1

- For high temperature applications
- High thermal resistance
- For extreme loads

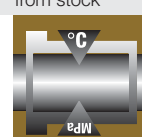

from stock

On the next pages you'll find iglidur® special materials on request and iglidur® special products (Slewing Ring Bearings, Clip Bearings, Flange Bearings, Thrust Bearings), available from stock



iglidur® – Special Materials, on Request



iglidur® B

Maximum Vibration Dampening

► Page 23.1

- Reduction of noise
- Very high elasticity
- Seal function possible



on request



iglidur® C

PTFE- and Silicone-Free

► Page 24.1

- PTFE and silicone-free
- Good abrasion resistance
- Maintenance-free

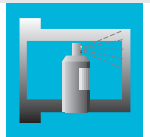

on request



iglidur® D

Low Friction, Low Cost

► Page 25.1

- Low cost
- Low coefficients of friction at high speeds

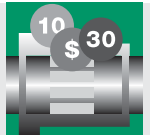

on request



iglidur® GLW

Strong and Reasonably Priced

► Page 26.1

- Low cost
- Applications with static loads

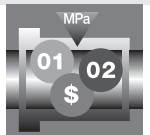

on request



iglidur® H2

Cost-Effective for Temperatures up to 200°C

► Page 27.1

- Low cost
- For high temperatures



on request



iglidur® J200

For Anodized Aluminium

► Page 28.1

- Very long service life with hard anodized aluminium
- Low coefficients of friction
- Low wear

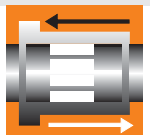

on request



iglidur® T220

For the Tobacco Industry

► Page 29.1

- Free of undesirable ingredients as requested by main manufacturers of tobacco products



on request



iglidur® UW500

The Underwater Specialist

► Page 30.1

- For underwater use at high temperatures
- For fast and constant movements

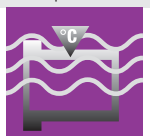

on request

TIP

► Shafts

DryLin® ► page 65.2

► Spherical Balls

iglidur® W300 spherical balls ► page 57.1



iglidur® – Special Products, from Stock



iglidur® Clip Bearings

► Page 31.1

- Secured with the double flange design
- Maintenance-free and self-lubricating
- Good wear resistance
- Smooth operation
- Material: iglidur® M250



from stock



iglidur® Clips2

Suitable for High Loads

► Page 32.1

- Low bearing clearance, very precise
- Easy installation due to angled slit
- Material: iglidur® M250
- Maintenance-free and predictable service life



from stock



iglidur® MKM

Double flange bearing

► Page 32.4

- Flanged at both ends
- Pressfit
- Axial preload
- Big axial forces
- Compensation of metal sheet tolerances



from stock



iglidur® MDM

Double flange bearing

► Page 32.4

- Simply clip-in assembly
- Flanged at both ends
- Symmetrical flanges
- Cannot be lost after paintshop process
- Easy assembly



from stock



iglidur® JVSM

Pre-tensioned, no clearance

► Page 33.1

- Bearing pre-tensioned
- Zero clearance, even under no load
- Material: iglidur® J
- Maintenance-free
- Predictable service life



from stock



iglidur® Flange Bearings

► Page 34.1

- Maintenance-free
- Very good wear resistance
- Material: iglidur® G, J, X or A180



from stock



iglidur® PEP

Polymer Encased Polymer (PEP)

► Page 35.1

- Cost-effective polymer bearing system
- Independent of the shaft material
- Independent of the shaft surface
- Protection of expensive and sensitive shafts



from stock



Polysorb

Polymer Disc Springs

► Page 36.1

- Compensation of axial clearances and manufacturing tolerances
- Vibration dampening
- Noise reduction
- Corrosion resistant
- Lightweight

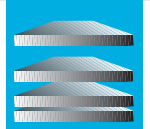

from stock



iglidur® JATM/VATM

Thrust Bearing

► Page 37.1

- Maintenance-free plain bearing system
- For high performance
- Corresponding sliding surfaces
- Predictable service life



from stock



iglidur® Sealed Bearing

► Page 37.3

- Polymer bearing with fitted radial shaft seal
- Seals against the rotating shaft
- Temperature range as iglidur® J
- Coefficient of friction only 10% higher than iglidur® J
- Wear as good as iglidur® J



from stock



iglidur® PRT

Slewing Ring Bearing

► Page 38.1

- Maintenance-free
- Low coefficients of friction
- High stiffness
- Cost-effective
- Robust



from stock



iglidur® stock bar



































► Page 39.1

- iglidur® materials as round stock bar or mechanically finished special parts









from stock

Main Properties of iglidur® bearing materials

	igidur® Materials	Speciality	 long life dry running	 for high loads	 for high temperatures	 low friction/high speed	 dirt resistant
Standard materials	 iglidur® G	Economical All rounder	●	●			●
	 iglidur® J	Low friction	●			●	
	 iglidur® M250	Best for vibration dampening	●				●
	 iglidur® W300	Wear resistant	●			●	●
	 iglidur® X	High temperatures, chemicals	●	●	●		
Bearing Material for special cases	 iglidur® A180	For wet environments, conforms with FDA	●			●	
	 iglidur® A200	Best for Food conforms with FDA					●
	 iglidur® A290	Best for Food conforms with BfR		●			
	 iglidur® A500	High temperatures conforms with FDA		●	●		
	 iglidur® F	Electrical conductor		●			
	 iglidur® H	Underwater applications			●		
	 iglidur® H1	For underbonnet applications	●		●	●	
	 iglidur® H4	Best for Automotive Industry	●		●	●	
	 iglidur® H370	Best for Underwater applications			●	●	
	 iglidur® L250	Best for fast rotations	●			●	
	 iglidur® P	Low Water absorption	●				●
	 iglidur® Q	Great for high loads	●	●		●	
	 iglidur® R	Low friction, low cost	●			●	
	 iglidur® UW	Specialist for underwater use					
	 iglidur® V400	Wear resistant at high temperatures	●		●	●	
	 iglidur® Z	Best for high loads	●	●	●	●	
Special Bearings on request	 iglidur® B	Very elastic					
	 iglidur® C	Free from PTFE and silicon					
	 iglidur® D	Highly cost-effective				●	
	 iglidur® GLW	Strong and Reasonably Priced					●
	 iglidur® H2	For Temperatures up to 200°C			●		
	 iglidur® J200	Linear movement (see DryLin®)	●			●	●
	 iglidur® T220	Tobacco industry					
 iglidur® UW500	Specialist for Underwater use (hot water)			●			

Selection According to Main Criteria

 chemical resistant	 low water absorption	 food suitable	 vibrations dampening	 edge pressure	 for under water use	 economic	Page
						●	2.1
	●			●		●	3.1
			●	●		●	4.1
				●		●	5.1
●	●				●		6.1
	●	●		●		●	7.1
		●	●	●			8.1
		●				●	9.1
●	●	●		●	●		10.1
							11.1
●	●				●		12.1
●	●			●	●		13.1
●	●			●	●	●	14.1
●	●				●		15.1
				●			16.1
	●					●	17.1
							18.1
	●			●		●	19.1
	●				●	●	20.1
●	●			●			21.1
●	●			●			22.1
			●	●			23.1
				●			24.1
	●			●		●	25.1
						●	26.1
●	●				●	●	27.1
	●			●			28.1
							29.1
●	●				●		30.1

Selection according to four main criteria

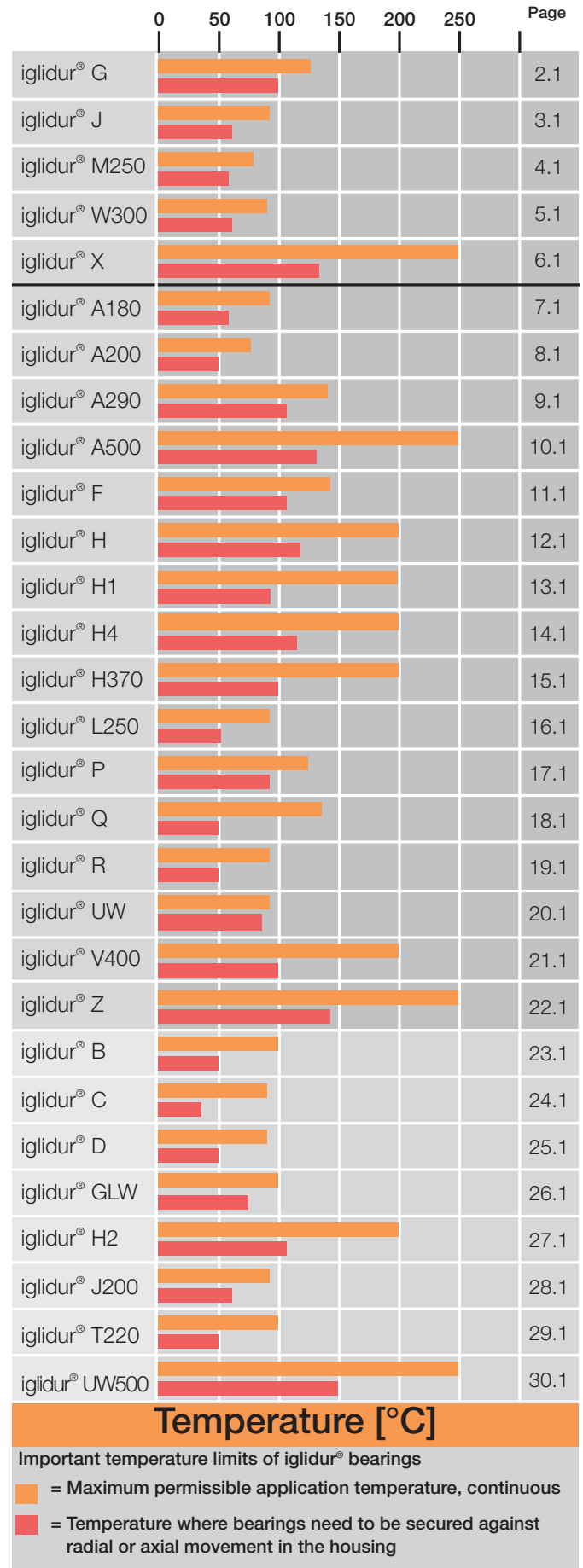
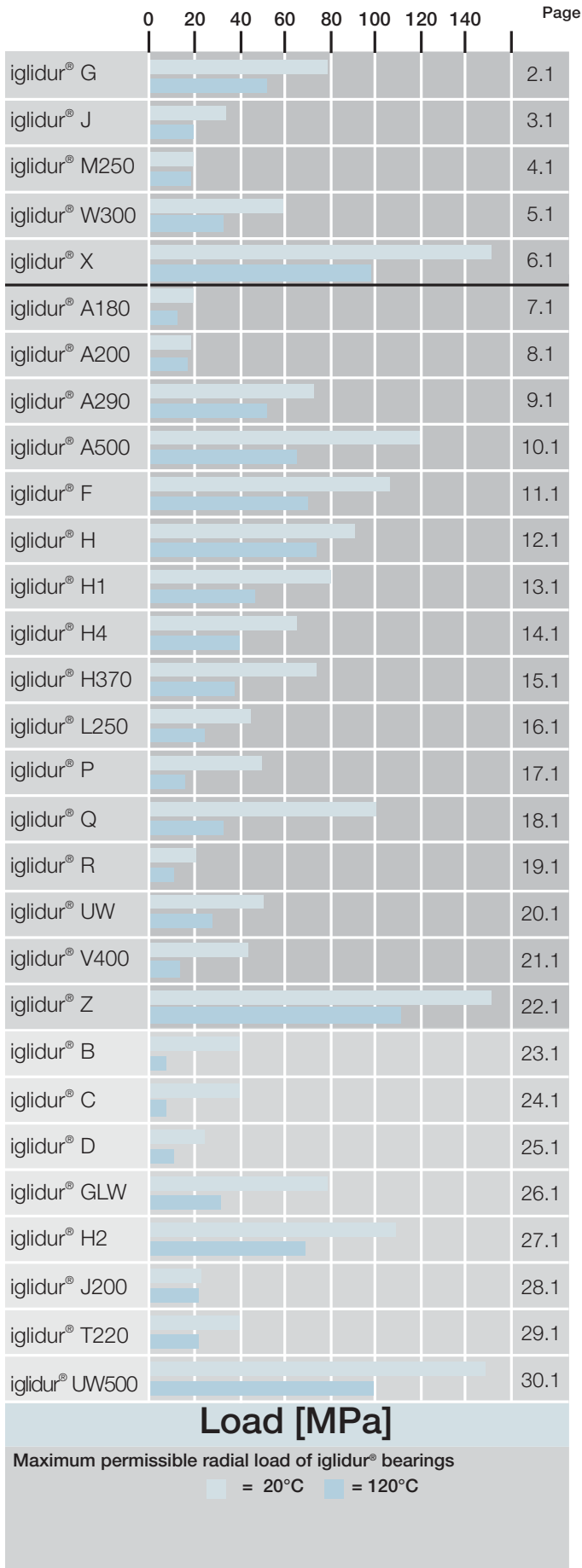

Reading example

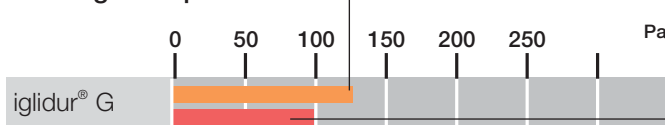

iglidur® G bearings can work with a temperature up to 130°C

iglidur® G bearings can work without being secured with a temperature up to 100°C

	0	0,1	0,2	0,3	0,4	0,5	Page
iglidur® G	3						2.1
iglidur® J	3						3.1
iglidur® M250	5						4.1
iglidur® W300	7						5.1
iglidur® X	4						6.1
iglidur® A180	4						7.1
iglidur® A200	4						8.1
iglidur® A290	3						9.1
iglidur® A500	4						10.1
iglidur® F	6						11.1
iglidur® H	3						12.1
iglidur® H1	1						13.1
iglidur® H4	3						14.1
iglidur® H370	3						15.1
iglidur® L250	4						16.1
iglidur® P	3						17.1
iglidur® Q	2						18.1
iglidur® R	1						19.1
iglidur® UW	3						20.1
iglidur® V400	2						21.1
iglidur® Z	3						22.1
iglidur® B	6						23.1
iglidur® C	4						24.1
iglidur® D	7						25.1
iglidur® GLW	1						26.1
iglidur® H2	3						27.1
iglidur® J200	6						28.1
iglidur® T220	3						29.1
iglidur® UW500	3						30.1

Coefficient of Friction

Coefficients of friction of iglidur® bearings sliding against steel, $p = 1,2 \text{ MPa}$, $v = 0,3 \text{ m/s}$

Coefficient of friction = of best combination

1 Cf53 2 Hard chromed
3 Alu. hc 4 Free-cutting Steel 5 St37 6 V2A 7 X90
■ = Average coefficient of all the seven sliding combinations tested

	0	5	10	15	20	Page	
iglidur® G	3						2.1
iglidur® J	3						3.1
iglidur® M250	3						4.1
iglidur® W300	3						5.1
iglidur® X	4						6.1
iglidur® A180	3						7.1
iglidur® A200	3						8.1
iglidur® A290	2						9.1
iglidur® A500	2						10.1
iglidur® F	1						11.1
iglidur® H	5						12.1
iglidur® H1	3						13.1
iglidur® H4	5						14.1
iglidur® H370	2						15.1
iglidur® L250	1						16.1
iglidur® P	1						17.1
iglidur® Q	3						18.1
iglidur® R	1						19.1
iglidur® UW	6						20.1
iglidur® V400	3						21.1
iglidur® Z	3						22.1
iglidur® B	1						23.1
iglidur® C	7						24.1
iglidur® D	7						25.1
iglidur® GLW	2						26.1
iglidur® H2	4						27.1
iglidur® J200	5						28.1
iglidur® T220	3						29.1
iglidur® UW500	6						30.1

Wear [$\mu\text{m}/\text{km}$]

Wear of iglidur® bearings sliding against steel, $p = 1 \text{ MPa}$

■ = Wear of best combination 1 Cf53 2 Hard chromed
3 Alu. hc 4 Free-cutting Steel 5 St37 6 V2A 7 X90
■ = Average wear of all the seven sliding combinations tested

Reading example

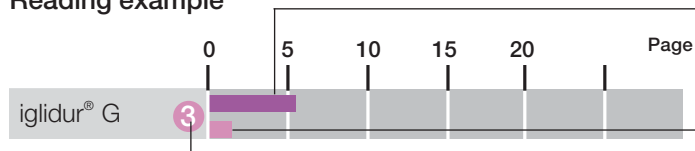

The average wear of iglidur® G against a CF53 shaft is $5,5 \mu\text{m}/\text{km}$

The average tested wear of iglidur® G against seven different shaft materials is only $1 \mu\text{m}/\text{km}$

iglidur® G gets the highest resistance to wear under the given loads with hard anodized aluminium.

iglidur® Material Table

If you don't know which Material you need, please go back to relevant Selection tables:

▶ According to main Properties, Page 1.8

▶ According to performance, Page 1.10

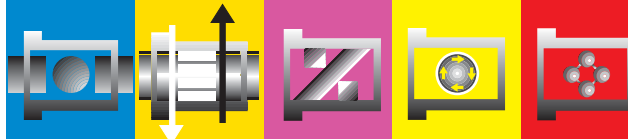

	iglidur® G	iglidur® J	iglidur® M250	iglidur® W300	iglidur® X
--	------------	------------	---------------	---------------	------------

General Properties

Standard materials

Density g/cm ³	1,46	1,49	1,14	1,24	1,44
Colour	Dark grey	Yellow	Charcoal	Yellow	Black
Max. moisture absorption at 23°C / 50% RH % weight	0,7	0,3	1,4	1,3	0,1
Max. moisture absorption % weight	4,0	1,3	7,6	6,5	0,5
Coefficient of sliding friction, dynamic against steel (μ)	0,08–0,15	0,06–0,18	0,18–0,40	0,08–0,23	0,09–0,27
p x v value, max. (dry) MPa x m/s	0,42	0,34	0,12	0,23	1,32

Mechanical Properties

Modulus of elasticity MPa	7800	2400	2700	3500	8100
Tensile strength at 20°C MPa	210	73	112	125	170
Compressive strength (axial) MPa	78	60	52	61	100
Max. permissible static surface pressure (20°C) MPa	80	35	20	60	150
Shore D-hardness	81	74	79	77	85

Physical and Thermal Properties

Max. long term application temperature °C	130	90	80	90	250
Max. short term application temperature °C	220	120	170	180	315
Min. application temperature °C	-40	-50	-40	-40	-100
Thermal conductivity [W/m x K]	0,24	0,25	0,24	0,24	0,60
Coefficient of thermal expansion (at 23°C) [K ⁻¹ x 10 ⁻⁵]	9	10	10	9	5

Electrical Properties

Specific volume resistance Ω cm	> 10 ¹³	> 10 ¹³	> 10 ¹³	> 10 ¹³	< 10 ⁵
Surface resistance Ω	> 10 ¹¹	> 10 ¹²	> 10 ¹¹	> 10 ¹²	< 10 ³

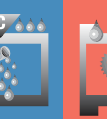

iglidur® A180

iglidur® A200

iglidur® A290

iglidur® A500

iglidur® F

iglidur® H

iglidur® H1

iglidur® H4

iglidur® H370

iglidur® L250

igus®
Plain Bearings

Phone +49 - 22 03 - 96 49-145
Fax +49 - 22 03 - 96 49-334



Special Bearing Materials

1,46	1,14	1,41	1,28	1,25	1,71	1,53	1,79	1,60	1,5
White	White	White	Brown	Black	Grey	Cream	Brown	Grey	Beige
0,2	1,5	1,7	0,3	1,8	< 0,1	0,1	0,1	< 0,1	0,7
1,3	7,6	7,3	0,5	8,4	0,3	0,3	0,2	< 0,1	3,9
0,05-0,23	0,10-0,40	0,13-0,40	0,26-0,41	0,10-0,39	0,07-0,20	0,06-0,20	0,08-0,25	0,07-0,17	0,08-0,19
0,31	0,09	0,23	0,28	0,34	1,37	0,8	0,7	0,74	0,4
2300	2500	8800	3600	11600	12500	2800	7500	11100	1950
88	116	250	140	260	175	55	120	135	67
78	54	91	118	98	81	78	50	79	47
20	18	70	120	105	90	80	65	75	45
76	81	88	83	84	87	77	80	82	68
90	80	140	250	140	200	200	200	200	90
110	170	180	300	180	240	240	240	240	180
-50	-40	-40	-100	-40	-40	-40	-40	-40	-40
0,25	0,24	0,24	0,24	0,65	0,60	0,24	0,24	0,50	0,24
11	10	7	9	12	4	6	5	5	10
> 10 ¹²	> 10 ¹³	> 10 ¹¹	> 10 ¹⁴	< 10 ³	< 10 ⁵	> 10 ¹²	> 10 ¹³	< 10 ⁵	> 10 ¹⁰
> 10 ¹¹	> 10 ¹²	> 10 ¹¹	> 10 ¹³	< 10 ²	< 10 ²	> 10 ¹¹	> 10 ¹¹	< 10 ⁵	> 10 ¹¹

iglidur® Material Table

If you don't know which Material you need, please go back to the Selection tables on Page:

▶ According to main Properties, Page 1.8

▶ According to performance, Page 1.10



	iglidur® P	iglidur® Q	iglidur® R	iglidur® UW	iglidur® V400	iglidur® Z
General Properties	Special Bearing Materials					
Density g/cm ³	1,58	1,40	1,39	1,56	1,51	1,40
Colour	Black	Black	Dark Red	Black	White	Brown
Max. moisture absorption at 23°C / 50% RH % weight	< 0,2	0,9	0,2	0,2	0,1	0,3
Max. moisture absorption % weight	0,4	4,9	1,1	0,8	0,2	1,1
Coefficient of sliding friction, dynamic against steel (μ)	0,06–0,21	0,05–0,15	0,09–0,25	0,15–0,35	0,15–0,20	0,06–0,14
p x v value, max. (dry) MPa x m/s	0,39	0,55	0,27	0,11	0,5	0,84
Mechanical Properties						
Modulus of elasticity MPa	5300	4500	1950	n. b.	4500	2400
Tensile strength at 20°C MPa	120	120	70	n. b.	95	95
Compressive strength (axial) MPa	66	89	68	70	47	65
Max. permissible static surface pressure (20°C) MPa	50	100	23	50	45	150
Shore D-hardness	75	83	77	78	74	81
Physical and Thermal Properties						
Max. long term application temperature °C	130	135	90	90	200	250
Max. short term application temperature °C	200	155	110	110	240	310
Min. application temperature °C	-40	-40	-50	-50	-50	-100
Thermal conductivity [W/m x K]	0,25	0,23	0,25	0,60	0,24	0,62
Coefficient of thermal expansion (at 23°C) [K ⁻¹ x 10 ⁻⁵]	4	5	11	6	3	4
Electrical Properties						
Specific volume resistance Ω cm	> 10 ¹³	> 10 ¹⁵	> 10 ¹²	< 10 ⁵	> 10 ¹²	> 10 ¹¹
Surface resistance Ω	> 10 ¹²	> 10 ¹²	> 10 ¹²	< 10 ⁵	> 10 ¹²	> 10 ¹¹
1.14	Page 17.1	Page 18.1	Page 19.1	Page 20.1	Page 21.1	Page 22.1

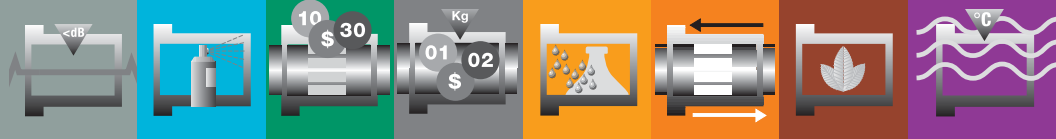

igidur® B

igidur® C

igidur® D

igidur® GLW

igidur® H2

igidur® J200

igidur® T220

igidur® UW500

igus®
Plain Bearings

Phone +49 - 22 03 - 96 49-145
Fax +49 - 22 03 - 96 49-334



Special Bearings on Request

1,15	1,1	1,40	1,36	1,69	1,72	1,28	1,49
Grey	White	Green	Black	Brown	Dark grey	White	Black
1,0	1,0	0,3	1,3	< 0,1	0,2	0,3	0,1
6,3	6,9	1,1	5,5	0,2	0,7	0,5	0,5
0,18–0,28	0,17–0,25	0,08–0,26	0,10–0,24	0,07–0,30	0,11–0,17	0,20–0,32	0,20–0,36
0,15	0,1	0,27	0,3	0,58	0,3	0,28	0,35
1750	1900	2000	7700	10300	2800	1800	16000
55	60	72	235	210	58	65	260
20	30	70	74	109	43	55	130
40	40	23	80	110	23	40	140
69	72	78	78	88	70	76	86
100	90	90	100	200	90	100	250
130	130	110	160	240	120	160	315
-40	-40	-50	-40	-40	-50	-40	-100
0,24	0,24	0,25	0,24	0,24	0,24	0,24	0,60
12	15	11	17	4	8	11	4
> 10 ¹⁰	> 10 ¹⁰	> 10 ¹⁴	> 10 ¹¹	> 10 ¹⁵	> 10 ⁸	> 10 ¹⁰	< 10 ⁹
> 10 ⁹	> 10 ⁹	> 10 ¹⁴	> 10 ¹¹	> 10 ¹⁴	> 10 ⁸	> 10 ¹⁰	< 10 ⁹



Picture 1.1: Every designer's dream: A life-time-predictable plain bearing without lubrication at low cost



Picture 1.2: Plain bearing laboratory



Picture 1.3: Testing the properties of polymer bearings

iglidur® – Plain Bearings Made From High Performance Polymers

Excellent polymers, improved by precise additions of reinforcing materials and lubricants, tested a thousand times and proven a million times.

Each year, igus® engineers develop more than one hundred new plastic compounds and test maintenance free plain bearings in more than 2,500 experiments per year. That's how in recent years they have built an extensive database of the tribological properties of polymers.

This database makes it possible for us to better assess most of the applications in advance, to calculate the expected service life, and provide our customer with confidence during use.

Fit it and Forget it

Based on the results of several thousand empirical tests, we are now able to provide you with reliable answers to almost all inquiries about the service life of iglidur® plain bearings. We can also recommend the most appropriate shaft material using the results from our testing database.

First Class Materials in the Injection Moulding Process

Very few basic materials can be modified and adapted as well as thermoplastics. Thermoplastics can be provided with lubricants, reinforced mechanically by the addition of technical fibres, or varied by additional filling materials, especially with regard to friction and wear behaviour.



General properties of iglidur®-Plain Bearings

- High dimensional accuracy
- High compressive strength
- Good heat dissipation
- Low heat relaxation
- Maintenance-free
- High dirt resistance
- Corrosion resistance
- High vibration dampening
- Very low tendency to creep

Plain Bearings – long service life at low cost

igus® develops materials that are well suited to the different requirements of maintenance-free plain bearings:

1. Plain bearings must, at times over many years, take high loads.
2. Maintenance-free plain bearings should have low coefficients of friction.
3. Their wear resistance should use for a long time.

Both in material development as well as in the design of bearings, former disadvantages of plastics can be greatly reduced. Thus iglidur® plain bearings are thin walled and some materials have especially high

thermal conductivity. Both features help to rapidly dissipate heat and thus directly increase the load capacity of the bearing.

Properties of iglidur® Bearings

Above and beyond the general properties, each iglidur® bearing material has a series of particular properties that create its suitability for certain applications and requirements. You'll find a detailed description of the materials in the following chapters together with a complete list of existing dimensions.



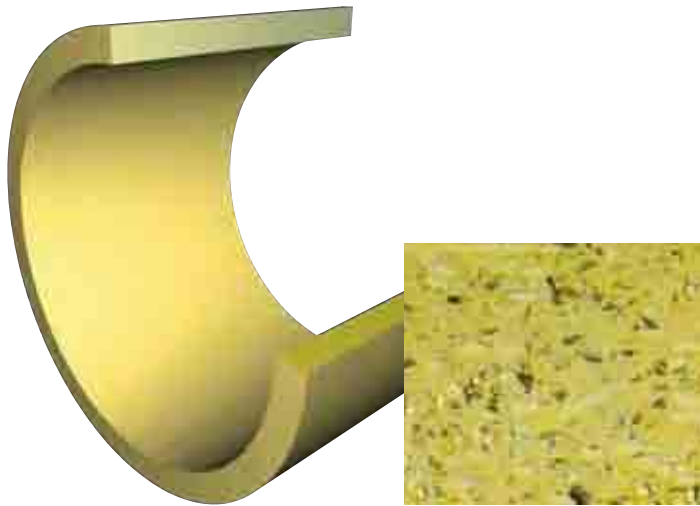

Figure 1.1: iglidur® plain bearings are homogeneously structured. Base polymer, bonding materials and solid lubricants mutually complement each other.



Figure 1.2: The traditional solution, bearing shells made of layers with lubricants and/or coating.



Picture 1.4: iglidur® plain bearings: Exactly the right bearing for every application

The Self-Lubricating Effect

The high performance polymers of the iglidur® plain bearing are composed of:

- base polymer
- fibres and filling materials
- solid lubricants

These components are not applied in layers, but instead are mixed together homogeneously. The advantage of this design is clear when the requirements are studied:

1. The coefficient of friction, which is determined especially by the surface of the bearing, should be as low as possible.
2. The surface cannot be removed by forces that act on the bearing
3. The wearing force acts especially on the surface of the bearing, for this the bearing must be capable of high resistance.

There is no such thing as a single, universal material that performs all of these functions well.

The Traditional Solution is:

Hard shells with soft coating. Every lubricated bearing works according to this principle, and also a number of maintenance-free bearings that are equipped with special slide layers. However, this soft slide layer is not strong enough. For high loads, edge pressure or oscillations, it is easily removed.

iglidur® Plain Bearings Function Differently

One component of the iglidur® materials acts for each function of the bearing:

- The **base polymers** are responsible for the resistance to wear
- **Fibres and filling materials** reinforce the bearing so that high forces or edge loads are possible
- **Solid lubricants** lubricate the bearing independently and prevent friction of the system.

Self-Lubrication

The solid lubricants are, as microscopically small particles, embedded in millions of tiny chambers of the mostly fibre reinforced material. From these chambers, the plain bearings release tiny amounts of solid lubricants during movement.

The solid lubricants help to lower the coefficient of friction of the iglidur® bearing. Since they are embedded in the tiny chambers, they cannot be pressed out. They are always there as soon as the bearing or the shaft is set in motion.

Base Polymers and Technical Fibres

The radial pressure with which the bearings are loaded is received by the polymer base material. In the contact area, this material provides a support to the shaft. The polymer base material ensures that the lubricants do not receive a surface pressure that is too high. The base material is also reinforced by technical fibres or filling materials. These additional materials stabilize the bearing especially in cases of continuous load.

The Start-up Phase

In the starting phase, the shaft and the iglidur® plain bearing become mated to one another. During this phase, the surfaces of both materials are adjusted to each other. The specific pressure of the system drops since the contact surfaces of the shaft and bearing expand during the start-up. At the same time, the rate of wear decreases and approaches a linear curve. In this phase, the coefficients of friction are changing until finally reaching a value that to a large extent is constant.

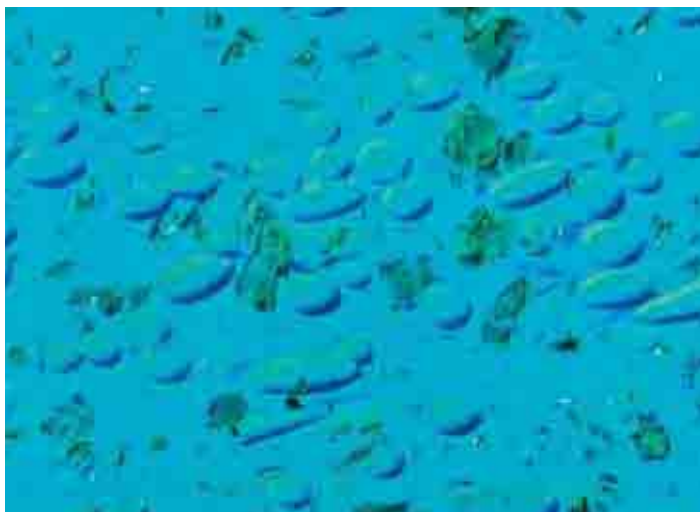

Picture 1.5: Base polymers with fibres and solid lubricants, magnified 200 times, dyed.

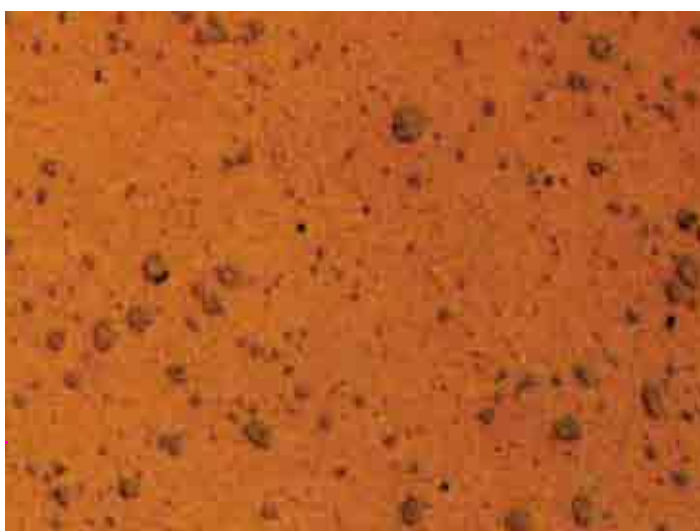

Picture 1.6: Base polymers without reinforcing materials with solid lubricants, magnified 50 times, dyed.

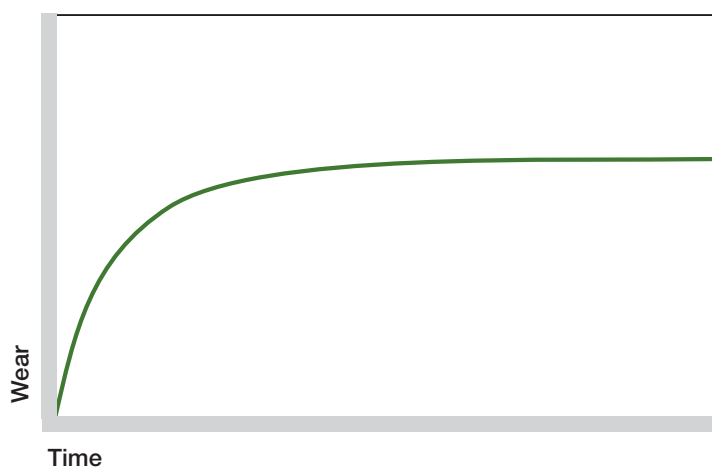

Graph 1.3: During the start-up phase, the rate of wear drops greatly.

igus®
Plain Bearings

Phone +49 - 22 03 - 96 49-145
Fax +49 - 22 03 - 96 49-334



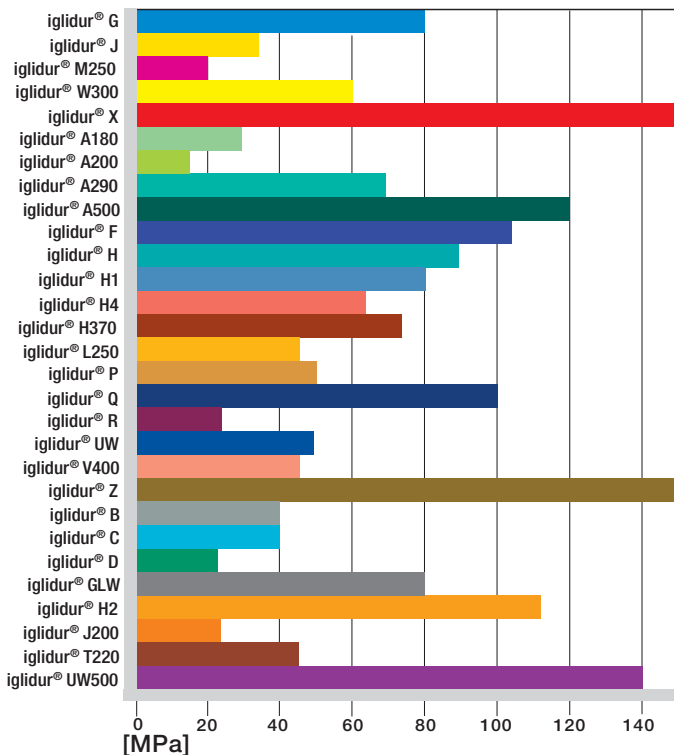

Graph 1.4: Recommended maximum static surface pressure at 20°C

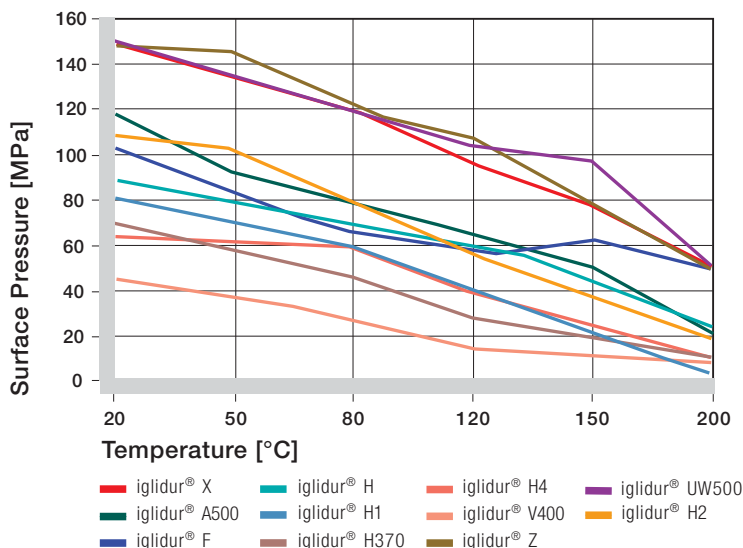
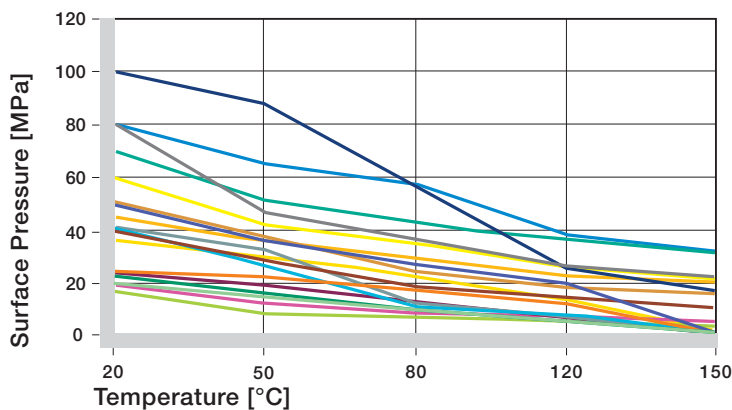

Graph 1.5: Recommended maximum surface pressure of iglidur® plain bearings as a function of temperature

Surface pressure

The load of a plain bearing is expressed by the surface pressure (p) in MPa. For this purpose, the radial load is determined on the projected surface of the bearing.

$$\text{Radial bearing: } p = \frac{F}{d1 \cdot b1}$$

For thrust bearings, the load is produced accordingly.

$$\text{Thrust bearing: } p = \frac{F}{(d2^2 - d1^2) \cdot \frac{\pi}{4}}$$

In this process:

- F load in N
- d1 bearing inner diameter in mm
- b1 bearing length in mm
- d2 outer diameter of the bearing in mm

Max. recommended Surface Pressure

A comparative value of the iglidur® material is the recommended maximum static surface pressure (p) at 20°C. The values of the individual iglidur® plain bearings differ greatly on this point. The value (p) indicates the pressure limit of a plain bearing. The plain bearing can carry this pressure permanently without damage. The given value applies to static operation; only very slow speeds up to 0.01 m/s are tolerated under this pressure. Higher pressures than those indicated are possible if the duration of the load is short. Please call us if you have questions.

► Material Table, page 1.10

Load and Temperature

Graph 1.5 shows the recommended maximum static surface pressure (p) of the iglidur® plain bearing as a function of temperature. When using the plain bearing, the bearing temperature can be higher than the ambient temperature, due to friction. Take advantage of the opportunity presented by the predictability of the iglidur® plain bearing to record these effects in advance, or determine the effective temperatures in the test.

Pressure and Speed

With decreasing radial load on the plain bearing, the permissible surface speed increases. The product of the pressure (p) and speed (v) can be understood as a measurement for the frictional heat of the bearing. This relationship is shown by the $p \times v$ graph that is the first in the respective chapter for each iglidur® material.

Pressure and Wear

The load of the plain bearing has an effect on the wear of the bearing. The following graphs show the wear behaviour of the iglidur® bearing materials. It is easily recognized that for each pressure, there is an optimal plain bearing available.

Pressure and Coefficient of Friction

With increasing load, the coefficient of friction of the plain bearing typically decreases. In this context, shaft materials and surfaces are also significant.

► Coefficient of Friction, page 1.24

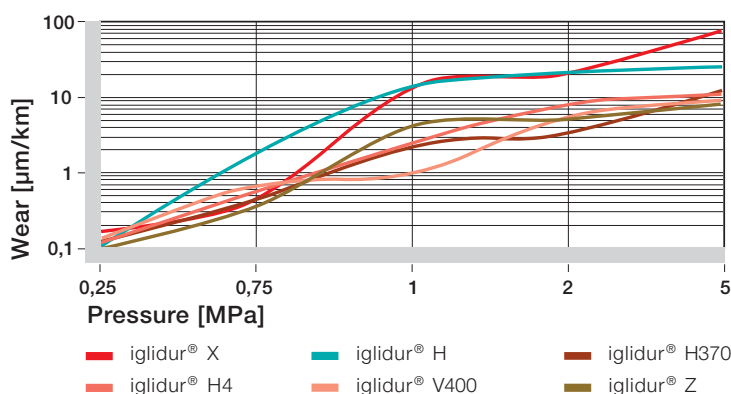
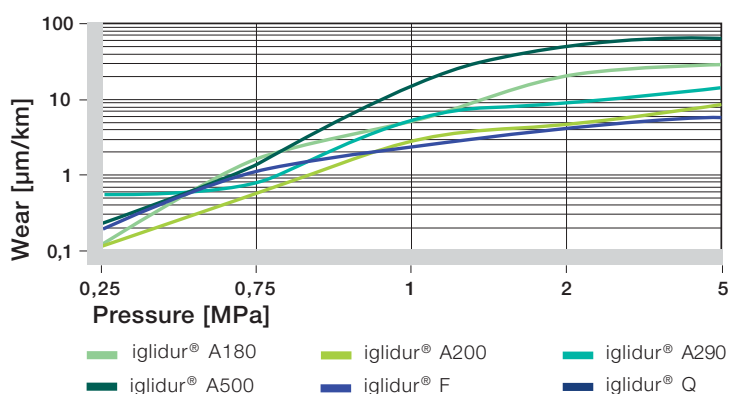
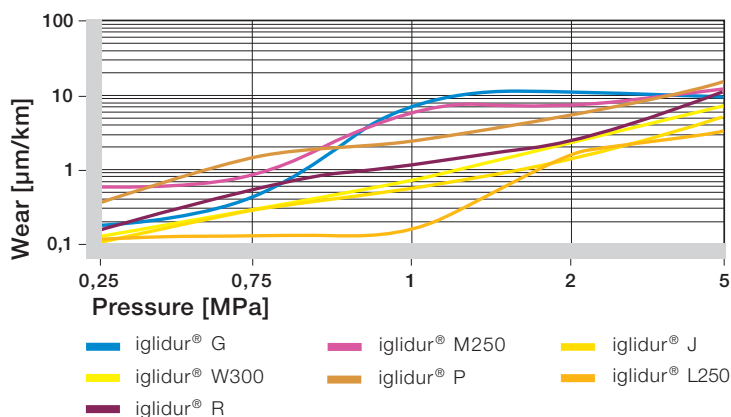

Graph 1.6: Wear of iglidur® plain bearings under low pressures

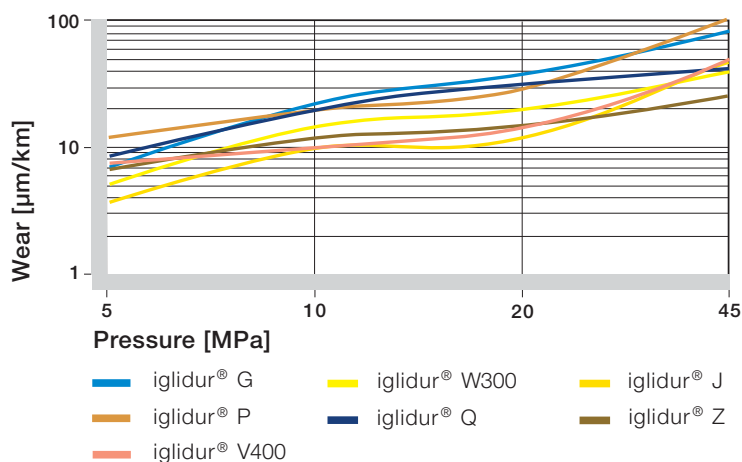

Graph 1.7: Wear of iglidur® plain bearings under medium and high pressures

igus®
Plain Bearings

Phone +49 - 22 03 - 96 49-145
Fax +49 - 22 03 - 96 49-334



Material	Rotating	Oscillating	Linear
iglidur® G	1	0,7	4
iglidur® J	1,5	1,1	8
iglidur® M250	0,8	0,6	2,5
iglidur® W300	1	0,7	4
iglidur® X	1,5	1,1	5
iglidur® A180	0,8	0,6	3,5
iglidur® A200	0,8	0,6	2
iglidur® A290	1	0,7	3
iglidur® A500	0,6	0,4	1
iglidur® F	0,8	0,6	3
iglidur® H	1	0,7	3
iglidur® H1	2	1,0	5
iglidur® H4	1	0,7	1
iglidur® H370	1,2	0,8	4
iglidur® L250	1	0,7	2
iglidur® P	1	0,7	3
iglidur® Q	1	0,7	5
iglidur® R	0,8	0,6	3,5
iglidur® UW	0,5	0,4	2
iglidur® V400	0,9	0,6	2
iglidur® Z	1,5	1,1	5
iglidur® B	0,7	0,5	2
iglidur® C	1	0,7	2
iglidur® D	1,5	1,1	8
iglidur® GLW	0,8	0,6	2,5
iglidur® H2	0,9	0,6	2,5
iglidur® J200	1	0,7	10
iglidur® T220	0,4	0,3	1
iglidur® UW500	0,8	0,6	2

Table 1.1: Surface speeds (constant) of the iglidur® plain bearing in m/s

Material	Rotating	Oscillating	Linear
iglidur® G	2	1,4	5
iglidur® J	3	2,1	10
iglidur® M250	2	1,4	5
iglidur® W300	2,5	1,8	6
iglidur® X	3,5	2,5	10
iglidur® A180	1,2	1	5
iglidur® A200	1,5	1,1	3
iglidur® A290	2	1,4	4
iglidur® A500	1	0,7	2
iglidur® F	1,5	1,1	5
iglidur® H	1,5	1,1	4
iglidur® H1	2,5	1,5	7
iglidur® H4	1,5	1,1	2
iglidur® H370	1,5	1,1	5
iglidur® L250	1,5	1,1	3
iglidur® P	2	1,4	4
iglidur® Q	2	1,4	6
iglidur® R	1,2	1	5
iglidur® UW	1,5	1,1	3
iglidur® V400	1,3	0,9	3
iglidur® Z	3,5	2,5	6
iglidur® B	1	0,7	3
iglidur® C	1,5	1,1	3
iglidur® D	3	2,1	10
iglidur® GLW	1	0,7	3
iglidur® H2	1	0,7	3
iglidur® J200	1,5	1,1	15
iglidur® T220	1	0,7	2
iglidur® UW500	1,5	1,1	3

Table 1.2: Surface speeds (short term) of the iglidur® plain bearing in m/s

Surface Speed

With plain bearings, the surface speed is critical. The rotational speed is not the limit, it is the sliding surface speed between the shaft and the bearing.

The surface speed is expressed in metres per second and calculated from the rotational speed with the following formula.

Rotational motion:
$$v = \frac{n \cdot d1 \cdot \pi}{60 \cdot 1000} \left[\frac{m}{s} \right]$$

Oscillating motion:
$$v = d1 \cdot \pi \cdot \frac{2 \cdot \beta}{360} \cdot \frac{f}{1000} \left[\frac{m}{s} \right]$$

in the process

d1 = Shaft diameter [mm]

f = frequency in Hertz

β = angle of motion per cycle [°]

n = RPM

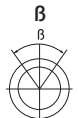

Permissible Surface Speeds

iglidur® plain bearings were primarily developed for low to average running speeds in continuous operation.

Table 1.1 shows the permissible surface speed of iglidur® plain bearings for rotating, oscillating, and linear movements.

These surface speeds are limit values assuming minimum pressure loading of the bearing.

In practice, these limit values are rarely reached due to an inverse relationship between load and speed. All increases of the pressure leads unavoidably to a reduction of the allowable surface speeds and vice versa.

The speed limit is determined by the thermal properties of the bearing. This is also the reason why different running speeds can occur for the different movement types.

For linear movements, more heat can be dissipated via the shaft, since the bearing uses a longer surface area on the shaft.

Surface Speed and Wear

Considerations regarding the permissible surface speeds should also include the wear resistance of the plain bearing. High running speeds automatically bring correspondingly high wear rates with them.

Surface Speed and Coefficient of Friction

In practice the coefficient of friction of plain bearings is a result of the surface speed. High surface speeds have a higher coefficient of friction than low surface speeds. Graph 1.8 shows this relationship by using the example of a Cold Rolled Steel shaft (Cf53) with a load of 0.7 MPa.

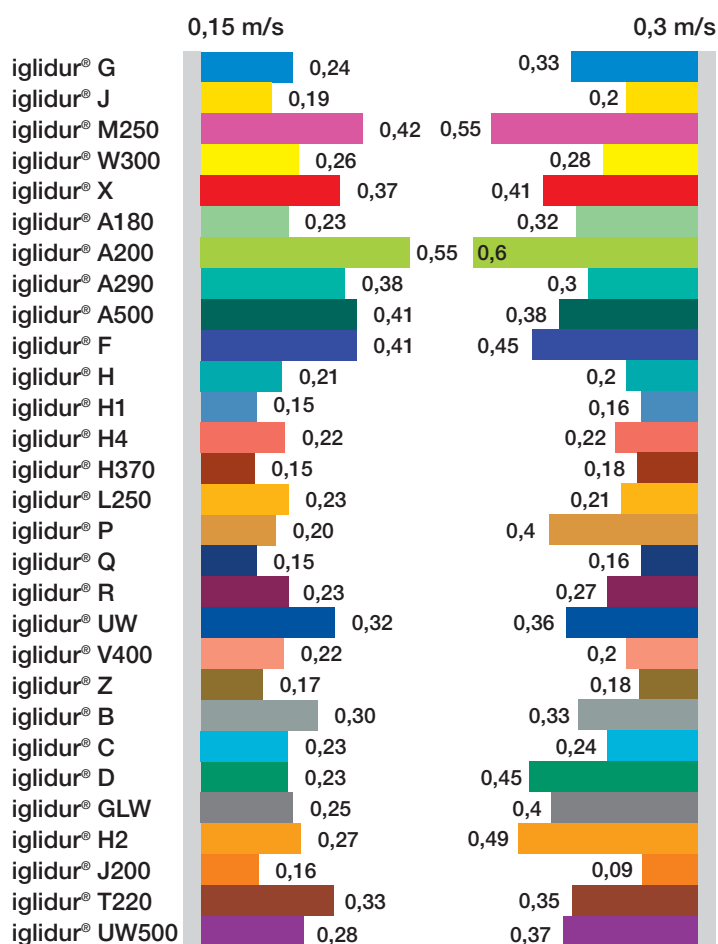

Graph 1.8: Coefficients of friction of iglidur® materials for different surface speeds



Picture 1.7: Experiments on wear and coefficient of friction with of an igubal® pillow block bearing



Picture 1.8: Determining the maximum surface speeds of an igubal® rod end bearing

igus®
Plain Bearings

Phone +49 - 22 03 - 96 49-145
Fax +49 - 22 03 - 96 49-334



$$p \times v_{zul.} = \left(\frac{[K1 \cdot \pi \cdot \lambda k \cdot \Delta T]}{\mu \cdot s} + \frac{[K2 \cdot \pi \cdot \lambda s \cdot \Delta T]}{\mu \cdot b1 \cdot 2} \right) \cdot 10^{-3}$$

where:

- K1, K2 = constant for heat dissipation (K1 = 0.5, K2 = 0.042)
- s = bearing wall thickness in mm
- b1 = bearing length in mm
- μ = coefficient of friction
- λs = thermal conductivity of the shaft
- λk = thermal conductivity of the bearing
- ΔT = (T_a - T_U)
- T_U = ambient temperature
- T_a = maximum application temperature

Material	Thermal Conductivity [W/m x k]
Steel	46
Aluminium	204
Grey cast iron	58
303 Stainless	16
Ceramics	1,4
Plastics	0,24

Table 1.3: Heat conductivity values of shaft or housing materials

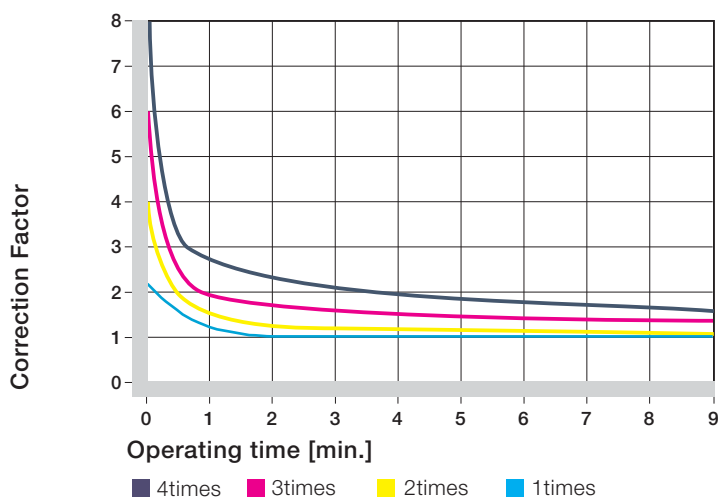

Graph 1.9: Correction factor for p x v value

Lubrication	Correction factor
Dry run	1
During installation	1,3
Continuous, grease	2
Continuous, water	4
Continuous, oil	5

Table 1.4: Correction of the tolerated p x v value by means of lubrication

p x v value

For plain bearings, the product is given a new value depending on the pressure (p) and the surface speed

The **p x v value** can be considered a measure of the frictional heat and can be used as an analytical tool to answer questions concerning the proper application of a plain bearing. For this purpose, the actual **p x v value** is a function of the shaft material of the ambient temperature and the operating time.

Correction Factor

The permissible **p x v value** can be increased in practical operation if the bearing temperature never reaches the maximum limit because of the short operating time. Tests have shown that this is true for operating times below 10 minutes. An important qualifier here is the ratio of the operating time and dwell times. It is known that a longer dwell time makes a greater contribution to re-cooling. The different curves of graph 1.9 represent different ratios (3x means that the dwell time is three times longer than the operating time).

Lubrication

Although iglidur® plain bearings are designed to run dry, they are quite compatible with standard oils and greases. A single lubrication during the installation improves the start-up behaviour and the coefficient of friction, thus reducing the frictional heat. Due to this effect, the permissible loads for plain bearings can be increased by lubrication. Numerous results from lubricated applications are available from experiments. For further information, please contact us. Table 1.4 shows the correction factors for **p x v value** using lubrication.

Please exercise caution when using lubrication with iglidur® plain bearings, especially in dirty environments. The lubricant can mix with hard dirt particles and form an effective grinding paste, resulting in accelerated wear.

Temperature

The temperature resistance of high performance polymer plain bearings is usually underestimated. Who would believe that plastic bearings can be used over 300°C? Data is often found in the literature about the continuous use temperature. The continuous use temperature is the highest temperature, which the plastic can withstand for a period of time without a reduction in the tensile strength of the material above or below a prespecified value. Please note, these standard test results have limited applications, since bearings are almost always under load.

Application Temperatures

The minimum application temperature is the temperature below which the material is so rigid and hard that it becomes too brittle for standard applications. The maximum continuous application temperature is the temperature which the material can endure without the properties changing considerably.

The maximum, short-term application temperature is the temperature above which the material becomes so soft, that it can only withstand small external loads. "Short term" is defined as a period of a few minutes. If the plain bearings are moved axially or axial forces occur, there is more opportunity for the bearing to lose pressfit. In these cases, axial securing of the bearing is necessary in addition to the pressfit.

Table 1.7 shows the maximum ambient temperatures to which the plain bearings can be exposed for a short-term. If these temperatures occur then additional pressure or speed cannot be applied. In fact, a relaxation of the bearings can occur at these temperatures, even without an additional load. Thus it is necessary to ensure that the bearing cannot slide out of the bore. This is achieved by changing bore design or additionally securing the bearing.

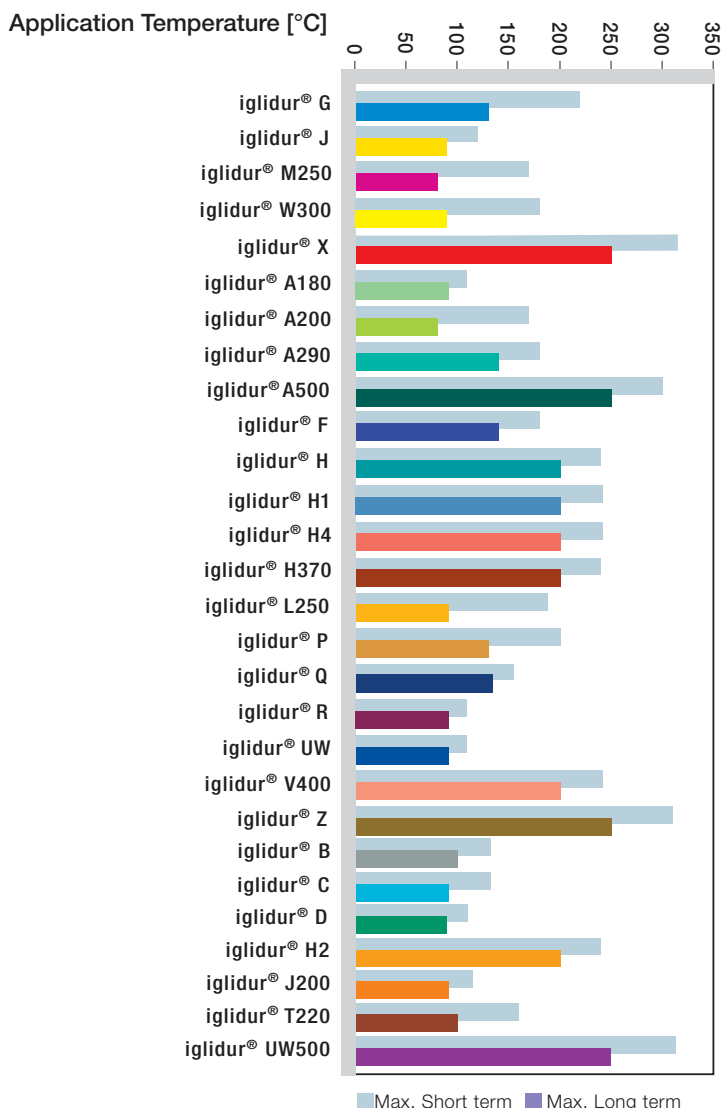

Graph 1.10: Comparison of the continuous and short term upper application temperature limits

Material	Lower application Temp. Limit [°C]	Material	Lower application Temp. Limit [°C]
iglidur® G	-40	iglidur® B	-40
iglidur® J	-50	iglidur® C	-40
iglidur® M250	-40	iglidur® D	-50
iglidur® W300	-40	iglidur® GLW	-40
iglidur® X	-100	iglidur® H2	-40
iglidur® A180	-50	iglidur® J200	-50
iglidur® A200	-40	iglidur® T220	-40
iglidur® A290	-40	iglidur® UW500	-100
iglidur® A500	-100		
iglidur® F	-40		
iglidur® H	-40		
iglidur® H1	-40		
iglidur® H4	-40		
iglidur® H370	-40		
iglidur® L250	-40		
iglidur® P	-40		
iglidur® Q	-40		
iglidur® R	-50		
iglidur® UW	-50		
iglidur® V400	-50		
iglidur® Z	-100		

Table 1.5: Lower application temperature limit of the iglidur® materials



Picture 1.9: iglidur® X bearing, hard friction setting, high temperatures

igus®
Plain Bearings

Phone +49 - 22 03 - 96 49-145
Fax +49 - 22 03 - 96 49-334





Picture 1.10: Material tests are possible up to 250°C

Material	Temperature at which additional security is required [°C]
iglidur® G	100
iglidur® J	60
iglidur® M250	60
iglidur® W300	60
iglidur® X	135
iglidur® A180	60
iglidur® A200	50
iglidur® A290	110
iglidur® A500	130
iglidur® F	105
iglidur® H	120
iglidur® H1	90
iglidur® H4	110
iglidur® H370	100
iglidur® L250	55
iglidur® P	90
iglidur® Q	50
iglidur® R	50
iglidur® UW	80
iglidur® V400	100
iglidur® Z	145
iglidur® B	50
iglidur® C	40
iglidur® D	50
iglidur® GLW	80
iglidur® H2	110
iglidur® J200	60
iglidur® T220	50
iglidur® UW500	150

Table 1.6: Temperature at which additional securing of the iglidur® plain bearing is required

Material	Max., short term ambient temp. [°C]
iglidur® G	220
iglidur® J	140
iglidur® M250	200
iglidur® W300	200
iglidur® X	315
iglidur® A180	110
iglidur® A200	200
iglidur® A290	230
iglidur® A500	315
iglidur® F	230
iglidur® H	260
iglidur® H1	240
iglidur® H4	260
iglidur® H370	260
iglidur® L250	200
iglidur® P	200
iglidur® Q	200
iglidur® R	140
iglidur® UW	140
iglidur® V400	250
iglidur® Z	310
iglidur® B	130
iglidur® C	150
iglidur® D	140
iglidur® GLW	200
iglidur® H2	260
iglidur® J200	140
iglidur® T220	170
iglidur® UW500	315

Table 1.7: Maximum ambient temperature, short term, without loading

Temperature and pressure

The compressive strength of plain bearings decreases as temperature increases. During this process, the materials react very differently from another iglidur® X for example, still of 52 MPa even at temperatures of 200°C.

Coefficient of Thermal Expansion

The thermal expansion of polymers is approximately 10 to 20 times higher when compared to metals. In contrast to metal, this expansion is non linear in plastics. The coefficient of thermal expansion of the iglidur® plain bearing is a significant reason for the required play in the bearing. At the given application clearance, seizing of the bearing to the shaft does not occur at high temperatures. The coefficient of thermal expansion of iglidur® plain bearings was examined for significant temperature ranges and the results are given in the individual materials tables, at the start of each chapter.

Coefficient of Friction

iglidur® plain bearings are self-lubricating by the addition of solid lubricants. The solid lubricants lower the coefficient of friction of the plain bearings and thus increase the wear resistance. The coefficient of friction measurement:

$$F_R = \mu \cdot F$$

Depending on whether an application is starting from a stopped position or the movement is in progress and needs to be maintained, a choice is made between static friction coefficient and the dynamic friction coefficient.

Coefficients of Friction and Surfaces

At study here is the relationship between coefficients of friction and surface roughness of shaft materials. It is clearly shown that the amount of friction is composed of different factors. If the shaft is too rough, abrasion levels play an important role. Small areas of unevenness that can interlock with each other must be worn off the surface.

When the surfaces are too smooth, however, higher adhesion results, i.e. the surfaces stick to each other. Higher forces are necessary to overcome the adhesion, which results from an increased coefficient of friction. Stick-slip can be the result of a large difference between static and dynamic friction and of a higher adhesive tendency of mating surfaces. Stick-slip also occurs due to intermittent running behaviour and can result in loud squeaking. Stick slip thus represents a cause for malfunction of plain bearings. Over and over again, it is observed that these noises do not occur or can be eliminated with rough shafts. Thus for applications that have a great potential for stick slip – slow movements, large resonance of the housings – attention must be paid to the optimal roughness of the shafts.

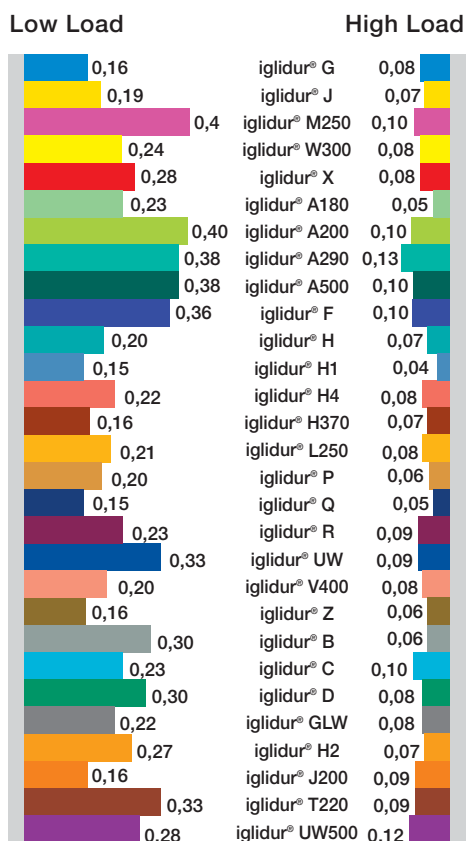

Graph 1.11: Frictional values of iglidur® materials under different loads

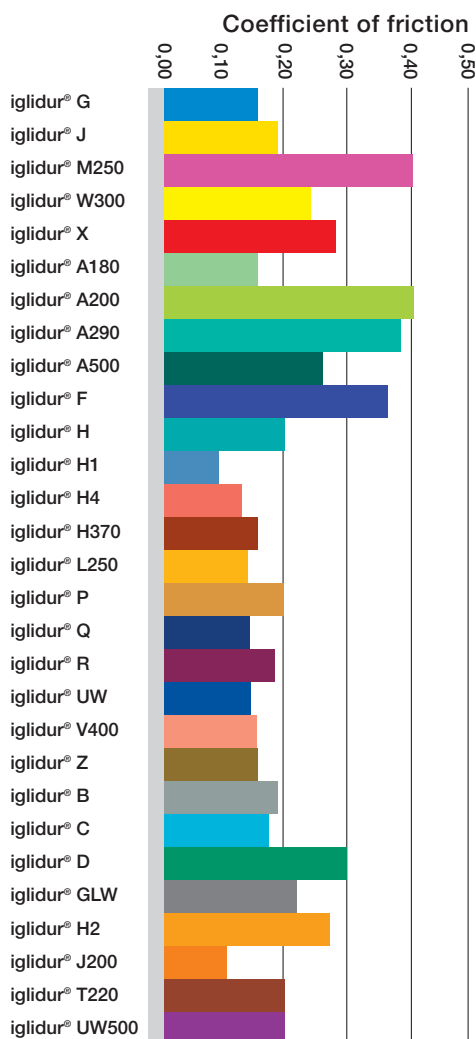

Graph 1.12: Coefficients of friction of the iglidur® plain bearings for the recommended surface roughness and low load, p = 0.75 MPa



Picture 1.11: Friction experiments in the iglus® laboratory



Picture 1.12: Erosion damage due to shafts that are too smooth



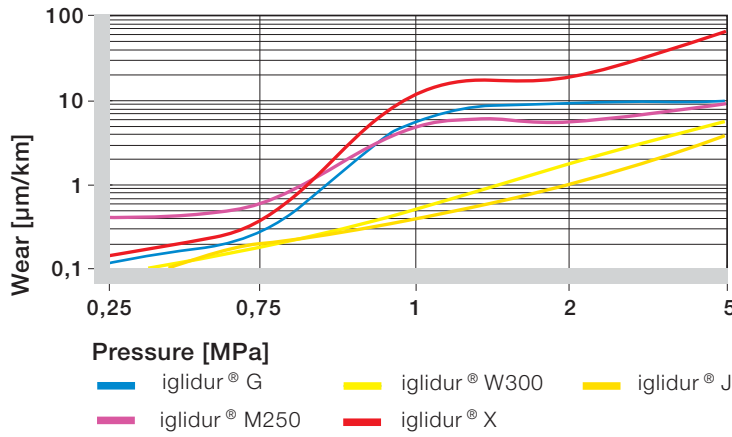

Fig 1.13: Wear of iglidur® plain bearings for low pressures, shaft: Cold Rolled Steel, Cf53, v = 0.1 m/s

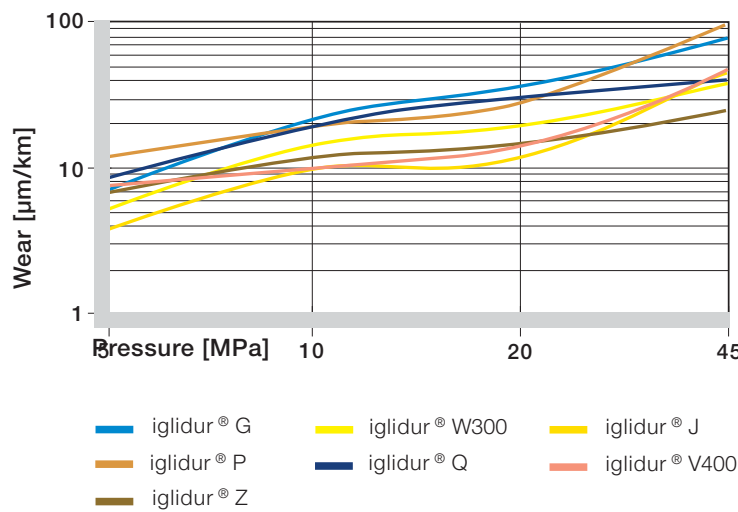

Fig 1.14: Wear of iglidur® plain bearings for medium and high pressures, shaft: Cold Rolled Steel, Cf53, v = 0.1 m/s



Picture 1.13: Test centre for high loads up to 150 MPa and temperatures up to 250°C, oscillating

Wear Resistance

Due to the fact that the wear of machine parts is a function of so many different influences, it is difficult to make general statements about the wear behaviour. Therefore, in numerous experiments, the wear is of primary importance as a measurement parameter. In testing, it has become clear what variances are possible between different material pairings. For given loads and surface speeds, the wear resistance can easily vary by a factor of 10 between materials pairings that run well together.

► Shaft Materials, page 1.28

Wear and Pressure

Different loads greatly influence the bearing wear. Among the iglidur plain bearings, certain materials are optimized for low loads, while others are better suited for high or extremely high loads. With a hardened, ground shaft, iglidur® J can be seen to be the most wear resistant bearing material for low loads. iglidur® Z on the other hand, is optimized for extreme loads.

For this, also see Graph 22.9 on page 22.6

Wear and Temperature

Within wide temperature ranges, the wear resistance of the iglidur® plain bearings shows little change. In the maximum temperature range, however, the temperature increases and the wear of the plain bearing increases.

The table on the following page compares the “wear limits”.

One particular exception is represented by iglidur® X. The wear resistance of iglidur® X increases greatly as temperature increases and reaches the optimum wear resistance at a temperature of 160°C. Then resistance decreases again, gradually.

Wear During Abrasive Dirt Accumulation

Special wear problems frequently occur if abrasive dirt particles get into the bearing. iglidur® plain bearings can clearly improve the operating time of machines and systems in these situations. The high wear resistance of the materials and the self lubrication process provide for the highest service lifetime. As no oil or grease is on the bearing, dirt particles can not penetrate as easily into the bearing. The largest portion simply falls away from the bearing thus limiting potential damage. If however, a hard particle penetrates into the bearing area, then an iglidur® plain bearing can absorb this particle. The foreign body becomes embedded in the wall of the bearing. Up to a certain point, operation can be maintained at optimal levels even when there is extreme dirt accumulation.

However, it's not just hard particles that can damage bearings and shafts. Soft dirt particles such as for example, textile or paper fibres, are frequently the cause for increased wear. In this instance, the dry run capability and the dust resistance of the iglidur® plain bearings go into action. In the past, this helped save costs in many applications.

Wear and Surfaces

Shaft surfaces are important for the wear of bearing systems. Similar to the considerations for coefficients of friction, a shaft can be too rough in regard to the bearing wear, but it can also be too smooth. A shaft that is too rough acts like a file and during movement separates small particles from the bearing surface. For shafts that are too smooth, however, higher wear can also occur. An extreme increase in friction results due to adhesion. The forces that act on the surfaces of the sliding face can be so large that regular material blow-outs occur. It is significant to note that wear by erosion is non linear. Moreover, it is random and can not be accurately predicted.

Material	Wear Limit [°C]
iglidur® G	120
iglidur® J	70
iglidur® M250	80
iglidur® W300	120
iglidur® X	210
iglidur® A180	70
iglidur® A200	80
iglidur® A290	120
iglidur® A500	190
iglidur® F	130
iglidur® H	120
iglidur® H1	170
iglidur® H4	120
iglidur® H370	150
iglidur® L250	120
iglidur® P	100
iglidur® Q	80
iglidur® R	70
iglidur® UW	70
iglidur® V400	130
iglidur® Z	200
iglidur® B	70
iglidur® C	70
iglidur® D	70
iglidur® GLW	100
iglidur® H2	120
iglidur® J200	70
iglidur® T220	90
iglidur® UW500	190

Table 1.8: Wear limits of iglidur® plain bearings



Picture 1.14: Wear test centre with temperature monitoring



Picture 1.15: High wear resistance: plain bearing in contact with sand

Phone +49 - 22 03 - 96 49-145
 Fax +49 - 22 03 - 96 49-334



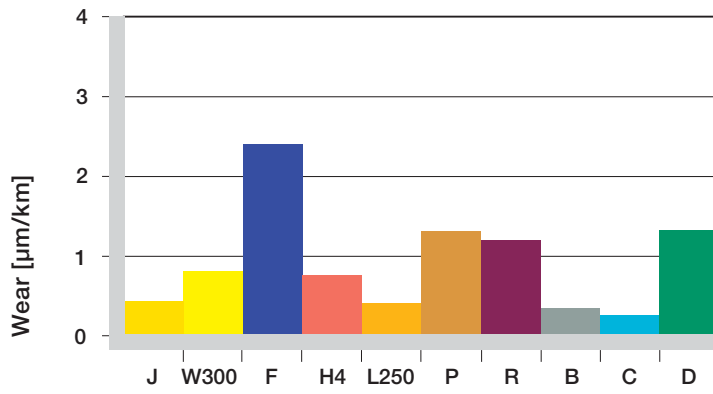

Graph 1.15: Wear with shaft Cold Rolled Steel, $p = 0.75 \text{ MPa}$, $v = 0.50 \text{ m/s}$, $Ra = 0.20 \text{ µm}$

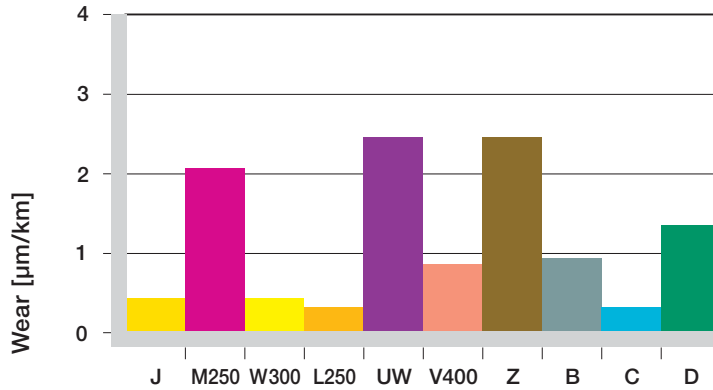

Graph 1.16: Wear with shaft 303 Stainless Steel, V2A, $p = 0.75 \text{ MPa}$, $v = 0.50 \text{ m/s}$, $Ra = 0.20 \text{ µm}$

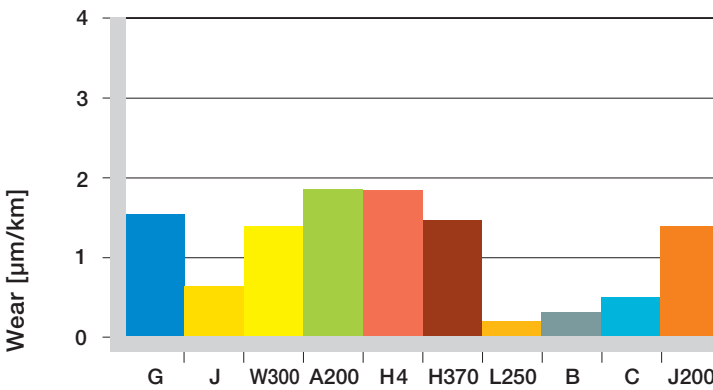

Graph 1.17: Wear with shaft HR Carbon Steel, $p = 0.75 \text{ MPa}$, $v = 0.5 \text{ m/s}$, $Ra = 0.20 \text{ µm}$

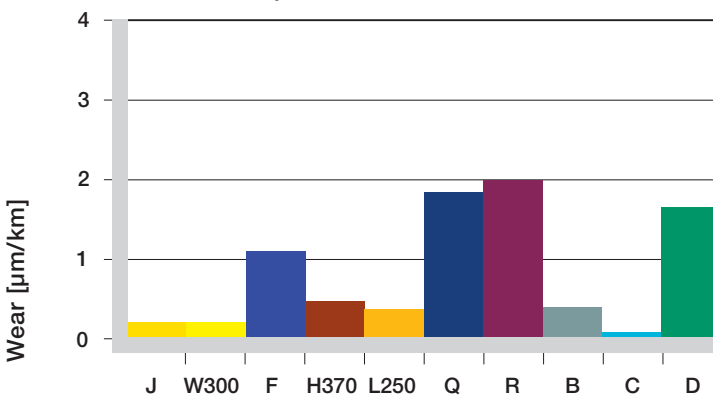

Graph. 1.18: Wear with hard chromed shaft, $p = 0.75 \text{ MPa}$, $v = 0.5 \text{ m/s}$, $Ra = 0.20 \text{ µm}$

Shaft Materials

The shaft is, next to the plain bearing itself, the most important parameter in a bearing system. It is in direct contact with the bearing, and like the bearing, it is affected by relative motion. Fundamentally, the shaft is also worn, however, modern bearing systems are designed in a way that the wear of the shafts is so small that it can not be detected with traditional methods of measurement technology.

Shafts can be distinguished and classified according to their hardness and according to the surface roughness. The effect of the surface is described on page 1.25:

- ▶ Coefficient of Friction, page 1.24
- ▶ Wear Resistance, page 1.26

The hardness of the shaft also plays an important role. When the shafts are less hard, the shaft is smoothed during the break-in phase. Abrasive points are worn off and the surface is rebuilt. For some materials, this effect has positive influences, and the wear resistance of the polymer bearing increases.

In the following graphs, the most common shaft materials are listed and the iglidur® materials that are best suited are compared. For easier comparison, the scaling of the wear axis is the same in all graphs.

The small wear results of the systems with hard-chromed shafts are especially impressive. This very hard, but also smooth shaft acts beneficially on the wear behaviour in many bearing pairs. The wear of many iglidur® plain bearings is lower on this shaft than on any other shaft material tested. However, it should be pointed out that because of the typically small surface roughness, the danger of stick slip on hard chromed shafts is especially high.

Such an overwhelmingly positive influence is not as readily available in the other shaft materials.

For example, with shafts made of 303 Stainless with low loads, good to excellent values can be obtained with the right bearing material. However, it must also be stated that no other shaft material produces a larger difference in wear among the bearing materials. For materials such as 303 Stainless Steel, therefore, the selection of suitable bearing materials is especially important.

Other soft shaft materials obtain a slightly different view with different bearing materials. With machining steel, the wear values of the seven best iglidur® bearing materials are in a narrow range between 0.6 and 1.8. For many other shafts, the influence of the shaft materials is much larger, resulting in a difference, up to 10 times, between the best and the worst of the bearings tested.

If the shaft that you have chosen for your application is missing in this overview, please call us. The test results give only a sample of the existing data.

All of the results shown were made with the loads $p = 0.75 \text{ MPa}$ and $v = 0.5 \text{ m/s}$. You can call us for the data for other $p \times v$ combinations.



Picture 1.16: Wear experiments with aluminum shafts

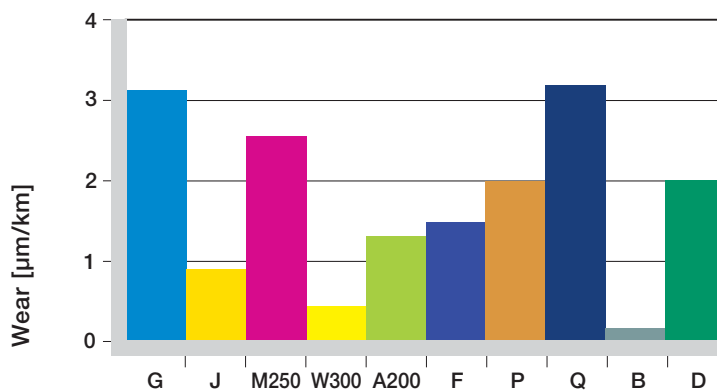

Graph 1.19: Wear with a silver steel shaft, $p = 0.75 \text{ MPa}$, $v = 0.5 \text{ m/s}$, $Ra = 0.20 \text{ µm}$

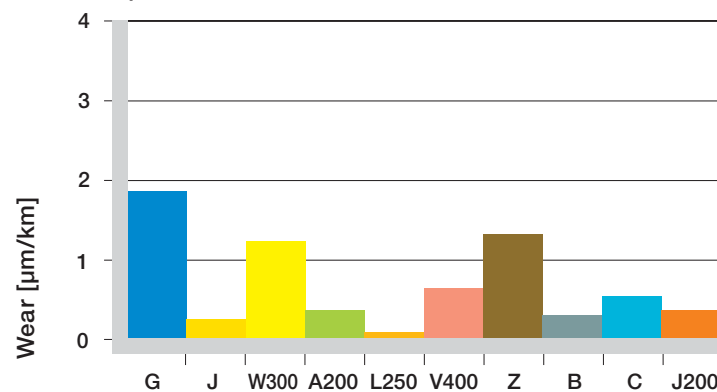

Graph 1.20: Wear with an aluminum shaft, $p = 0.75 \text{ MPa}$, $v = 0.5 \text{ m/s}$, $Ra = 0.20 \text{ µm}$

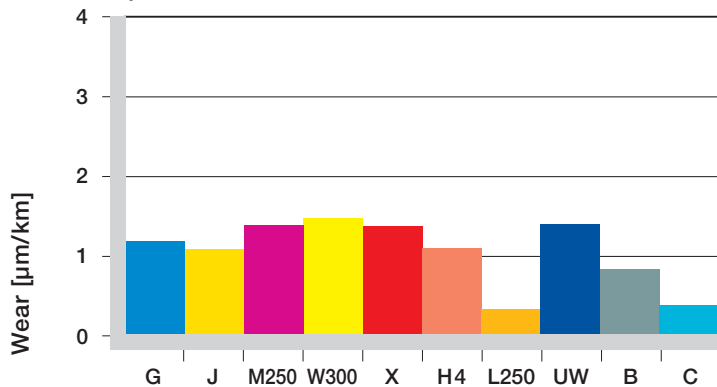

Graph 1.21: Wear with a machining steel shaft, $p = 0.75 \text{ MPa}$, $v = 0.5 \text{ m/s}$, $Ra = 0.20 \text{ µm}$

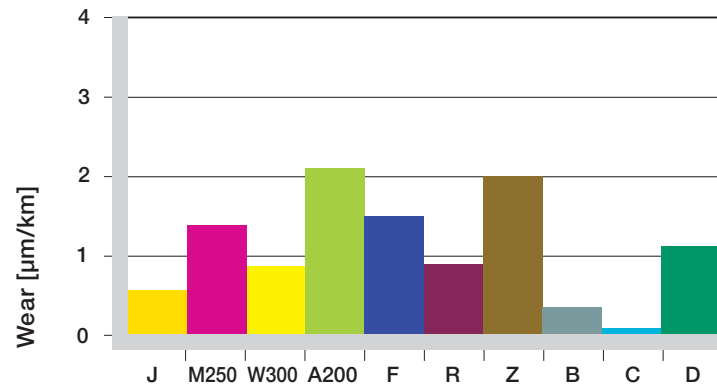

Graph 1.22: Wear with shaft X90, $p = 0.75 \text{ MPa}$, $v = 0.5 \text{ m/s}$, $Ra = 0.20 \text{ µm}$

igus®
Plain Bearings

Phone +49 - 22 03 - 96 49-145
Fax +49 - 22 03 - 96 49-334



Material	Hydro-carbon	Fat, oils without additives	diluted acids	diluted bases
iglidur® G	+	+	0 to -	+
iglidur® J	+	+	0 to -	+
iglidur® M250	+	+	0 to -	+
iglidur® W300	+	+	0 to -	+
iglidur® X	+	+	+	+
iglidur® A180	+	+	0 to -	+
iglidur® A200	+	+	0 to -	+
iglidur® A290	+	+	0 to -	+
iglidur® A500	+	+	+	+
iglidur® F	+	+	0 to -	+
iglidur® H	+	+	+ to 0	+
iglidur® H1	+	+	+ to 0	+
iglidur® H4	+	+	+ to 0	+
iglidur® H370	+	+	+ to 0	+
iglidur® L250	+	+	0 to -	+
iglidur® P	-	+	0	-
iglidur® Q	+	+	0 to -	+
iglidur® R	+	+	0 to -	+
iglidur® UW	+	+	0 to -	+
iglidur® V400	+	+	+	+
iglidur® Z	+	+	+	+
iglidur® B	-	-	0 to -	-
iglidur® C	+	+	0 to -	+
iglidur® D	+	+	0 to -	+
iglidur® GLW	+	+	0 to -	+
iglidur® H2	+	+	+ to 0	+
iglidur® J200	+	+	0 to -	+
iglidur® T220	-	+	0	-
iglidur® UW500	+	+	+	+

Table 1.9: Chemical resistance
+ resistant 0 conditionally resistant - not resistant



Picture 1.17: Rotational test centre for underwater and/or chemicals

Chemical Resistance

iglidur® plain bearings can come into contact with many chemicals during their use. This contact can lead to changes of the structural properties. The behaviour of plastics towards a certain chemical is dependent on the temperature, the length of exposure, and the type and amount of the mechanical loading. If iglidur® plain bearings are resistant against a chemical, they can be used in these media. Sometimes, the surrounding media can even take on the role of a lubricant.

With the most resistant iglidur® material iglidur® X the lubricant can even be hydrochloric acid. All iglidur® plain bearings can be used in diluted acids and diluted alkalines. Differences can result at higher concentrations or higher temperatures.

For all iglidur® plain bearings, the resistance against traditional lubricants applies in the same way. Therefore plain bearings may also be used lubricated. However, in dirty environments, a traditional lubricant can decrease the wear resistance when compared to running dry.

The following overview should quickly assist you:

If it is not completely clear in a design application which of the different chemicals can occur or in which concentration, plain bearings made out of iglidur® X should be used. This has the best resistance and is only attacked by a few concentrated acids. You'll find a detailed list of chemical resistances in the rear of the catalogue.

► Chemical Resistance, page 70.1

Application in the food Industry

The iglidur® program with 4 specially developed bearing materials is prepared for the special requirements in machines and equipment for the food industry. iglidur® A180, A200 and iglidur® 500 materials are made according to the requirements of the American Food and Drugs Administration (FDA). iglidur® A290 material is according to the requirements of the BfR (Bundesinstitut für Risikobewertung).

Radioactive Radiation

A comparison of the resistance to radioactive radiation is shown in the adjacent table. By a wide margin iglidur® X, UW500, A500 and Z are the most resistant materials.

UV Resistance

Plain bearings can be exposed to constant weathering when they are used outside. The UV resistance is an important measurement and indicates whether a material is attacked by UV radiation. The effects can extend from slight changes in colour to brittleness of the material. A comparison of the materials to each other is shown in the following table. The results show that iglidur® plain bearings are suitable for outside use. Only for a few iglidur® materials are any changes expected.

Material	Radiation resistance	Material	Radiation resistance
iglidur® X, UW500, Z	1 x 10 ⁵ Gy	iglidur® A500	2 x 10 ⁵ Gy
iglidur® A200, M250	1 x 10 ⁴ Gy	iglidur® L250	3 x 10 ⁴ Gy
iglidur® P	5 x 10 ² Gy	iglidur® C, V400	2 x 10 ⁴ Gy
iglidur® A180, A290, G, J, W300, F, Q, D, J200, B, T220, UW, R	3 x 10 ² Gy	iglidur® H4, H1	2 x 10 ² Gy
iglidur® H, H2, H370	2 x 10 ² Gy		

Table 1.10: Comparison of the radiation resistance of iglidur® plain bearings

Material	Points UV resistance	Material	Points UV resistance
iglidur® G	+++++	iglidur® P	+++++
iglidur® J	+++	iglidur® Q	++
iglidur® M250	++++	iglidur® R	++++
iglidur® W300	+++	iglidur® UW	+++
iglidur® X	+++++	iglidur® V400	+++
iglidur® A180	+++	iglidur® Z	+++
iglidur® A200	++++	iglidur® B	+
iglidur® A290	++++	iglidur® C	+
iglidur® A500	+++	iglidur® D	+++++
iglidur® F	+++++	iglidur® GLW	+++++
iglidur® H	++	iglidur® H2	+
iglidur® H1	++	iglidur® J200	+++
iglidur® H4	+	iglidur® T220	++
iglidur® H370	+++++	iglidur® UW500	+++++
iglidur® L250	+++		

Table 1.11: UV resistance of iglidur® plain bearings



Picture 1.18: iglidur® plain bearing in UV test

igus®
Plain Bearings

Phone +49 - 22 03 - 96 49-145
Fax +49 - 22 03 - 96 49-334



Material	Surface resistance [Ω]
iglidur® F	$1,5 \times 10^1$
iglidur® H	$8,8 \times 10^1$
iglidur® H370	$2,8 \times 10^3$
iglidur® X	$6,9 \times 10^2$
iglidur® UW	$1,6 \times 10^3$
iglidur® UW500	$5,0 \times 10^3$

Table 1.12: Electrical properties of conductive iglidur® plain bearings

Vacuum

iglidur® plain bearings can be used in a vacuum to a limited extent. Only a small amount of outgassing takes place. In most iglidur® plain bearings, the outgassing does not change the material properties.

Electrical Properties

In the product range of the maintenance-free, self lubricating iglidur plain bearings, there are both insulating as well as electrically conductive materials. The most important electrical properties are given in detail in the individual material descriptions. The adjacent table compares the most important electrical properties of conductive iglidur® plain bearings.

The iglidur® plain bearings not mentioned here are usually electrically insulating. Please observe that for some materials the properties can be changed by the absorption of moisture. In experiments, it should be tested whether the desired properties are also stable when the conditions are changing.

Tolerances and Measurement System

The installation dimensions and tolerances of the iglidur® plain bearings are a function of the material and wall thicknesses. For each material, the moisture absorption and the thermal expansion are imperative. Plain bearings with low moisture absorption can be designed with a minimal amount of tolerance. For wall thickness, the rule is: The thicker the bearings are, the larger the tolerances must be.

Thus, different tolerance classes exist for iglidur® plain bearings:

Within these tolerances, iglidur® plain bearings can operate in the permissible temperature range and in humidity conditions up to 70% according to the installation recommendations. Should higher air moisture levels be present, or the bearing is used under water, we provide advice with regard to applications, in order to help you use your bearings correctly.

Testing Methods

iglidur® plain bearings are pressfit bearings for bores machined to our recommendations. This pressfitting of the bearing fixes the bearing in the housing, and the inner diameter of the plain bearing is also formed upon pressfit.

The bearing test is performed when the bearing is installed in a bore with the minimum specified dimension; both using an indicating caliper and a Go No-Go gauge.

- the "Go-Side" of the Go-No-Go gauge, pressed into the bore, must pass easily through the bearing
- With the 3 point probe, the inner diameter of the bearing after pressfit must lie within the prescribed tolerance on the measurement plane, see drawing 1.23.



Picture 1.19: Measurement of the inner diameter of a pressfit plain bearing

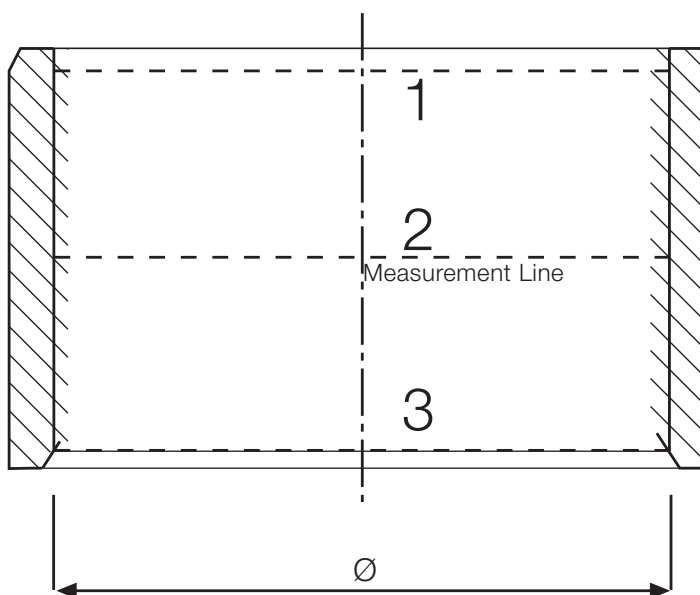

Drawing 1.23: The position of the measurement planes

igus®
Plain Bearings

Phone +49 - 22 03 - 96 49-145
Fax +49 - 22 03 - 96 49-334



Process	Turning	Boring	Milling
Tool material	SS	SS	SS
Feed [mm]	0,1 ... 0,5	0,1 ... 0,5	> 0,5
Tool relief angle	5 ... 15	10 ... 12	
Tool rake angle	0 ... 10	3 ... 5	
Cutting speed [m/min]	200 ... 500	50 ... 100	> 1000

Table 1.13: Guidelines for machining

Troubleshooting

In spite of careful manufacturing and assembly of the bearings, differences and questions regarding the recommended installation dimensions and tolerances can result. For this reason, we have compiled a list of the most frequent reasons for differences. In many cases, with this troubleshooter, the reasons for the differences can be found quickly.

- The bore is not chamfered properly – the bearing material is removed upon press-fitting. The correct chamfer should be 25 to 30 degrees, not 45 degrees.
- A centering pin was used which expanded the inside diameter of the bearing during pressfit.
- The bore does not meet the recommended housing bore specifications (usually H7).
- The housing is made out of a soft material that was expanded by the bearing installation.
- The shaft is not within recommended tolerances.
- The measurement is not performed within the same parameters shown.

Machining

iglidur® plain bearings are delivered ready to fit. The extensive product line makes it possible to use a standard dimension in most cases. If for some reason, a subsequent machining of the plain bearing is necessary, table 1.13 shows the machining standard values.

The subsequent machining of the running surfaces is to be avoided if possible. Higher wear rate is most often the result. An exception is the iglidur® M250 which is very suitable for secondary machining. In other iglidur® plain bearings, disadvantages of a sliding surface machining can be counteracted by lubrication during installation.

Installation

iglidur® plain bearings are produced oversized as standard. The inner diameter adjusts only after pressfit in the proper housing bore with a recommended tolerance. The before pressfit oversized dimension can be up to 2% of the inner diameter. In this manner, the secure pressfitting of the bearing is achieved. Axial or radial shifts in the housing are also prevented.

The bore in the housing should be finished in the recommended tolerance (usually H7) for all bearings and be as smooth, flat, and chamfered when possible with an angle of 25 to 30 degrees.

The bearing should be press fitted using a flat press. The use of centering or calibrating pins can cause damage to the bearing and create a larger amount of clearance.



Picture 1.21: The installation

Adhesion

Using an adhesive to fit an iglidur bearing is not usually necessary. If the pressfit of the bearing could be lost because of high temperatures, the use of a plain bearing having a higher temperature resistance is recommended.

If however, the securing of the bearing by adhesives is planned, individual tests are necessary in each case. The transfer of successful results to other application cases is not possible.

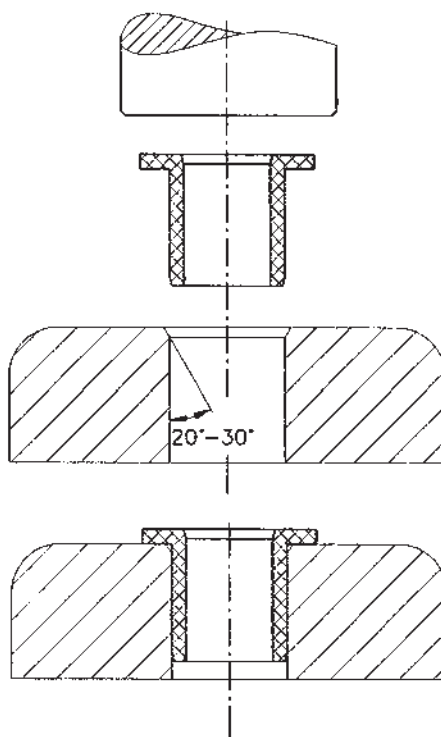

Drawing 1.24: Section view: pressfit of the bearing



