



# Brushed DC motors

## » Series GR/G

The Dunkermotoren GR/G range (commutated DC motors) are notable for:

- » Longer life than commutated motors from other manufacturers
- » Low detent torques
- » High efficiency
- » High dynamic acceleration
- » Good regulation characteristics
- » Maintenance-free
- » Robust design
- » Low moment of inertia
- » Extremely high short time overload capacity of the motor
- » Surface protection
- » Minimum interference radiation, optional interference suppression
- » Protection up to IP 65 (GR 42, GR 53, GR 63, GR 63S, GR 80)
- » High quality due to fully automated production lines

The DC motors can be combined with control electronics, gearboxes, brakes and encoders in a modular system to provide a flexible, adaptable, market-oriented solution.

# Bürstenbehaftete DC-Motoren

## » Baureihe GR/G

Dunkermotoren der Baureihen GR/G (Kollektor-Gleichstrommotoren) zeichnen sich aus durch:

- » Höhere Lebensdauer als Kollektormotoren anderer Hersteller
- » Geringe Rastmomente
- » Hoher Wirkungsgrad
- » Dynamische Beschleunigung
- » Gute Regelbarkeit
- » Wartungsfreiheit
- » Robuster Aufbau
- » Geringes Trägheitsmoment
- » Extrem hohe Kurzzeitüberlastfähigkeit des Motors
- » Oberflächenschutz
- » Minimale Störstrahlaussendung, optional Entstörvarianten
- » Schutzart bis zu IP 65 (GR 42, GR 53, GR 63, GR 63S, GR 80)
- » Höchste Qualität aufgrund vollautomatisierter Fertigungsstrecken

Die Gleichstrommotoren ergeben im Baukastensystem zusammen mit Regelelektroniken, Getrieben, Bremsen und Istwertgebern ein flexibles, anpassungsfähiges und marktorientiertes Sortiment.

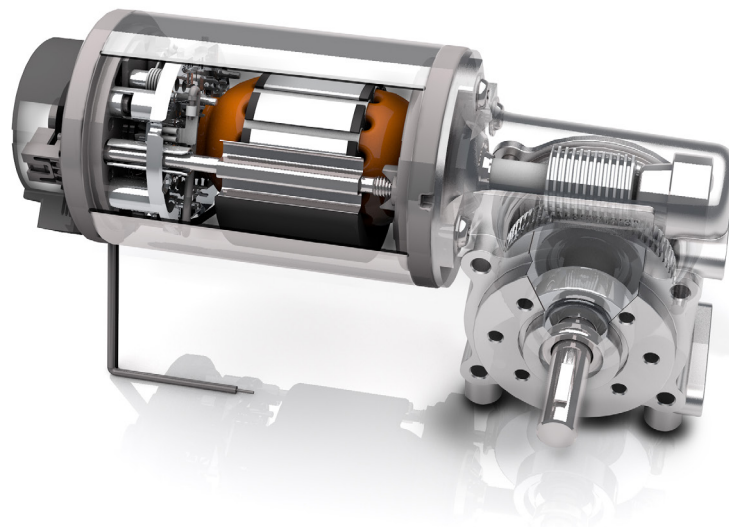

Page/ Seite 34	Motor G 30.2	4 W
Page/ Seite 36	Motor G 30.1   G 30.1S	7 W
Page/ Seite 38	Motor G 30.0   G 30.0S	10 W
Page/ Seite 40	Motor GR 42x25	15 W
Page/ Seite 42	Motor GR 42x40	21 W
Page/ Seite 44	Motor GR 53x30	39 W
Page/ Seite 46	Motor GR 53x58	61 W
Page/ Seite 48	Motor GR 63x25	50 W
Page/ Seite 50	Motor GR 63x55	99 W
Page/ Seite 52	Motor GR 63Sx55	126 W
Page/ Seite 54	Motor GR 80x40	128 W
Page/ Seite 56	Motor GR 80x80	240 W

- » Mechanical commutation through multi bar commutator provides long lifetime
- » Operation in both directions of rotation
- » Sleeve bearing at motor shaft is standard
- » Optionally with ball bearing, custom shaft length and diameter, special winding on request

- » Mechanische Kommutierung über vielteiligen Kollektor bietet lange Lebensdauer
- » Drehrichtung Rechts-/ Linkslauf
- » Motorwelle gleitgelagert ist Standard
- » Optional kugelgelagert, abweichende Wellenlängen und -durchmesser, Litzenausführung auf Anfrage

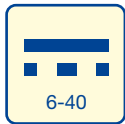
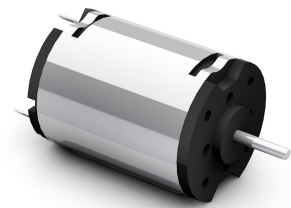

Supply voltage versions



High efficiency



Low noise



Protection class (up to)

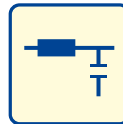

Interference suppression optional

Data/ Technische Daten		G 30.2		
Nominal voltage/ Nennspannung	VDC	12	24	40
Nominal current/ Nennstrom	A <sup>*)</sup>	0.6	0.31	0.21
Nominal torque/ Nennmoment	Nm <sup>*)</sup>	0.01	0.01	0.01
Nominal speed/ Nennzahl	rpm <sup>*)</sup>	2900	3000	3500
Stall torque/ Anhaltmoment	Nm <sup>**)</sup>	0.03	0.03	0.0327
Maximum torque/ Maximales Moment	Nm <sup>**)</sup>	0.03	0.03	0.0327
No load speed/ Leerlaufzahl	rpm <sup>*)</sup>	4650	5000	5400
Nominal output power/ Dauerabgabeleistung	W <sup>*)</sup>	3.04	3.14	3.67
Maximum output power/ Maximale Abgabeleistung	W	3.65	4.06	4.62
Torque constant/ Drehmomentkonstante	Nm A <sup>-1**)</sup>	0.0232	0.0435	0.0649
Terminal Resistance/ Anschlusswiderstand	Ω	8.58	31.1	72.7
Terminal inductance/ Anschlussinduktivität	mH	5.15	21.8	49.5
Starting current/ Anlaufstrom	A <sup>*)</sup>	1.4	0.77	0.55
No load current/ Leerlaufstrom	A <sup>*)</sup>	0.145	0.076	0.054
Demagnetisation current/ Entmagnetisierungsstrom	A <sup>*)</sup>	0.0	0.0	0.0
Rotor inertia/ Rotor Trägheitsmoment	gcm <sup>2</sup>	11.0	11.5	11.0
Weight of motor/ Motorgewicht	kg	0.08	0.08	0.08

\*) Δθ<sub>w</sub> = 100 K; \*\*) θ<sub>R</sub> = 20°C \*\*\*) at nominal point/ im Nennpunkt  Preference/ Vorzugsreihe  On request/ auf Anfrage

### Modular System/ Modulares Baukastensystem

- » Encoder/ Geber
  - MG 2
  - RE 22
  - RE 30 (TI)

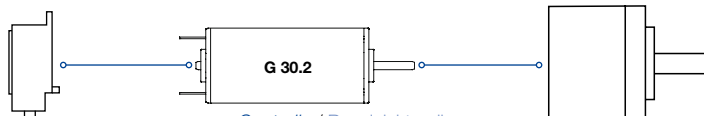

- » Controller/ Regelelektroniken
  - RS 200
  - BGE 6005 A
  - BGE 6010 A

- » Planetary Gearboxes/  
Planetengetriebe
  - PLG 30
  - PLG 30 H
  - PLG 32
  - PLG 32 H
  - PLG 42 K
  - PLG 42 S

You can individually configure your suitable product and download technical data and drawings for the combination at [www.dunkermotoren.com/en/configuration/](http://www.dunkermotoren.com/en/configuration/)  
 Unter [www.dunkermotoren.de/konfigurator](http://www.dunkermotoren.de/konfigurator) können Sie Ihr passendes Produkt individuell konfigurieren und technische Daten und Zeichnung für die Kombination herunterladen.

Dimensions in mm/ Maßzeichnung in mm

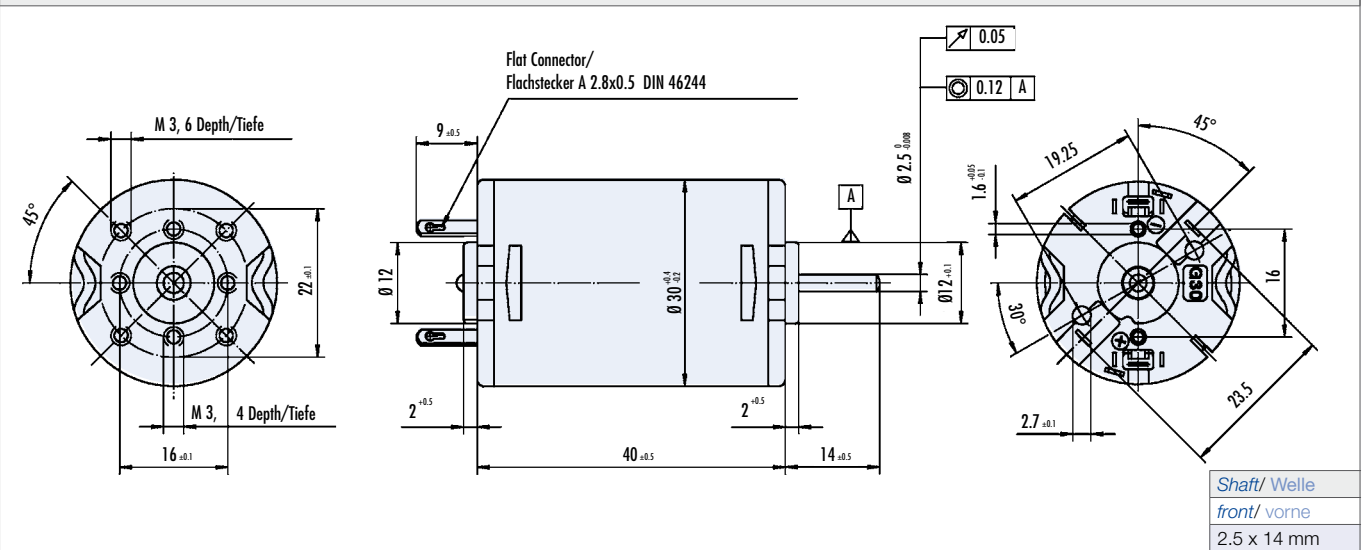

Characteristic diagram/ Belastungskennlinien

In accordance with/ Belastungskennlinien gezeichnet nach EN 60034

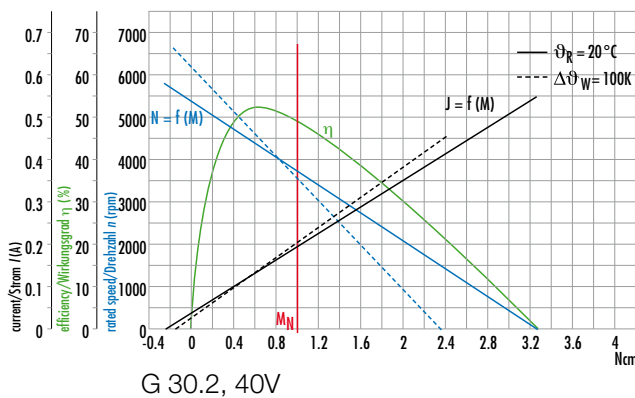
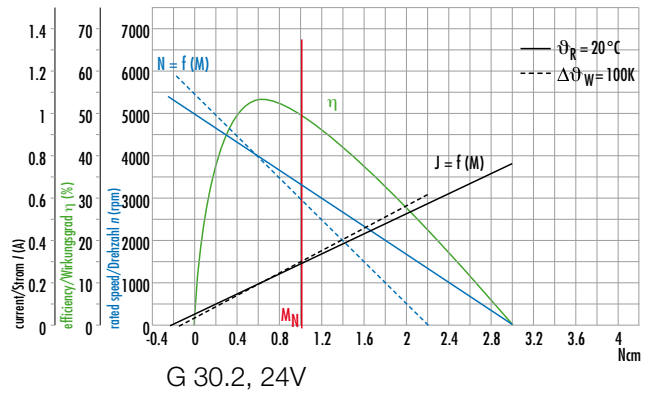
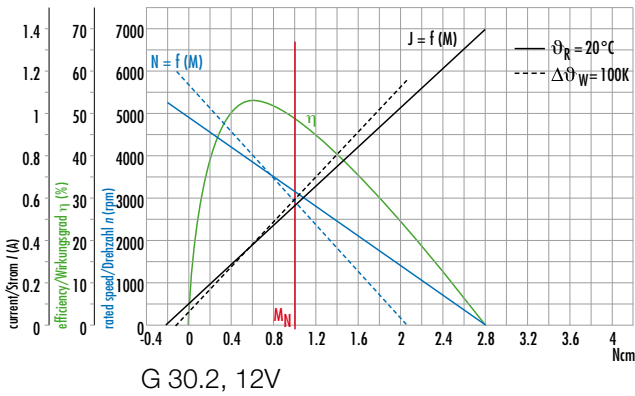

- » Mechanical commutation through multi bar commutator provides long lifetime
- » Operation in both directions of rotation
- » Sleeve bearing at motor shaft is standard
- » Optionally with ball bearing, custom shaft length and diameter, lead version on request

- » Gleichstrommotor mit stärkeren Permanentmagneten
- » Mechanische Kommutierung über vierteiligen Kollektor bietet lange Lebensdauer
- » Drehrichtung Rechts-/ Linkslauf
- » Motorwelle gleitgelagert ist Standard
- » Optional kugellagert, abweichende Wellenlängen und -durchmesser, Litzenausführung auf Anfrage

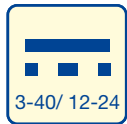

Supply voltage versions



High efficiency



Low noise



Protection class (up to)

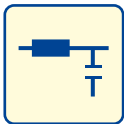

Interference suppression optional

Data/ Technische Daten		G 30.1			G 30.1S		
Nominal voltage/ Nennspannung	VDC	12	24	40	12	24	40
Nominal current/ Nennstrom	A <sup>*)</sup>	0.9	0.45	0.28	0.90	0.45	0.28
Nominal torque/ Nennmoment	Nm <sup>*)</sup>	0.0165	0.017	0.0175	0.020	0.020	0.020
Nominal speed/ Nenn Drehzahl	rpm <sup>*)</sup>	3300	3400	3600	3000	3100	3250
Stall torque/ Anhaltmoment	Nm <sup>*)</sup>	0.064	0.067	0.069	0.069	0.082	0.076
Maximum torque/ Maximales Moment	Nm <sup>*)</sup>	0.064	0.067	0.069	0.069	0.082	0.076
No load speed/ Leerlauf Drehzahl	rpm <sup>*)</sup>	4750	4800	5300	3950	4000	4500
Nominal output power/ Dauerabgabeleistung	W <sup>*)</sup>	5.7	6.1	6.6	6.4	6.49	6.4
Maximum output power/ Maximale Abgabeleistung	W	7.95	8.4	9.5	7.14	8.59	9.23
Torque constant/ Drehmomentkonstante	Nm A <sup>-1**)</sup>	0.0237	0.046	0.0702	0.0280	0.0559	0.087
Terminal Resistance/ Anschlusswiderstand	Ω	4.21	15.68	38.5	4.61	15.68	40.0
Terminal inductance/ Anschlussinduktivität	mH	3.64	14.2	33.5	3.68	14.1	30
Starting current/ Anlaufstrom	A <sup>*)</sup>	2.85	1.53	1.04	2.60	1.53	0.95
No load current/ Leerlaufstrom	A <sup>*)</sup>	0.175	0.09	0.064	0.18	0.10	0.08
Demagnetisation current/ Entmagnetisierungsstrom	A <sup>*)</sup>	0.0	0.0	0.0	0.0	0.0	0.0
Rotor inertia/ Rotor Trägheitsmoment	gcm <sup>2</sup>	18.5	19.5	18.5	18.5	19.5	18.5
Weight of motor/ Motorgewicht	kg	0.11	0.11	0.11	0.11	0.11	0.11

\*)  $\Delta\theta_w = 100\text{ K}$ ; \*\*)  $\theta_n = 20^\circ\text{C}$  \*\*) at nominal point/ im Nennpunkt  Preference/ Vorzugsreihe  On request/ auf Anfrage

### Modular System/ Modulares Baukastensystem

» Encoder/ Geber

- MG 2
- RE 22
- RE 30 (TI)

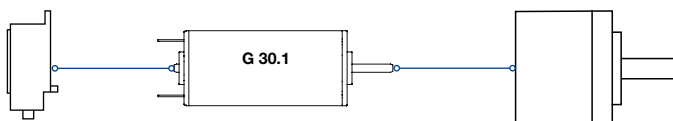

» Controller/ Regelelektroniken

- RS 200
- BGE 6005 A
- BGE 6010 A

» Planetary Gearboxes/  
Planetengetriebe

- PLG 30
- PLG 30 H
- PLG 32
- PLG 32 H
- PLG 42 K
- PLG 42 S

You can individually configure your suitable product and download technical data and drawings for the combination at [www.dunkermotoren.com/en/configuration/](http://www.dunkermotoren.com/en/configuration/)

Unter [www.dunkermotoren.de/konfigurator](http://www.dunkermotoren.de/konfigurator) können Sie Ihr passendes Produkt individuell konfigurieren und technische Daten und Zeichnung für die Kombination herunterladen.

Dimensions in mm/ Maßzeichnung in mm

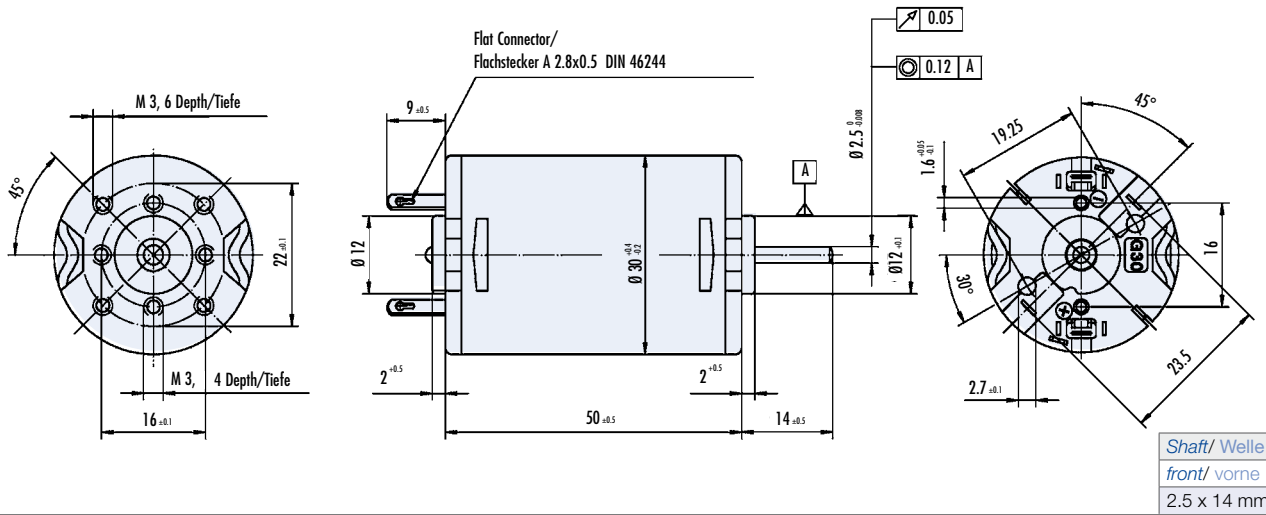

Characteristic diagram/ Belastungskennlinien

In accordance with/ Belastungskennlinien gezeichnet nach EN 60034

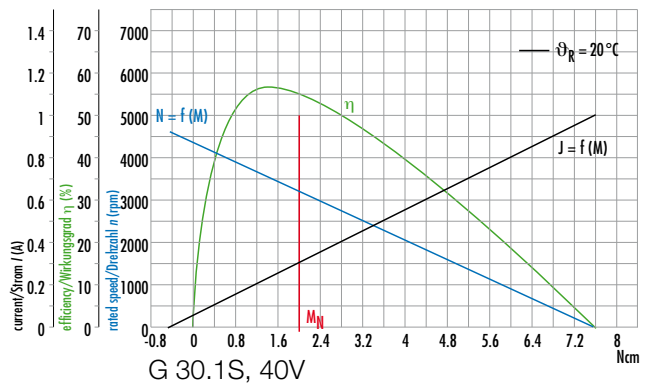
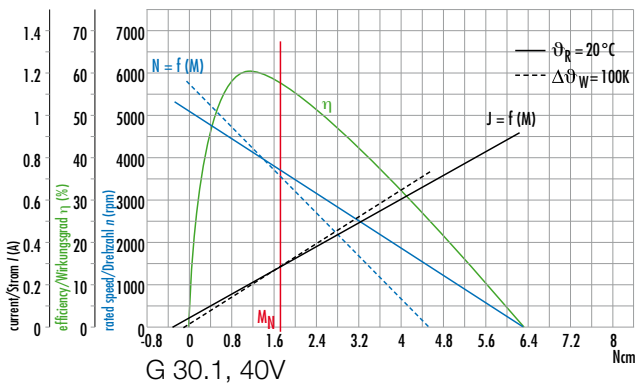
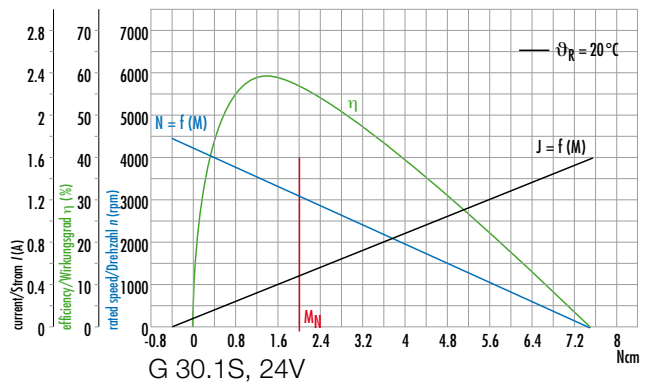
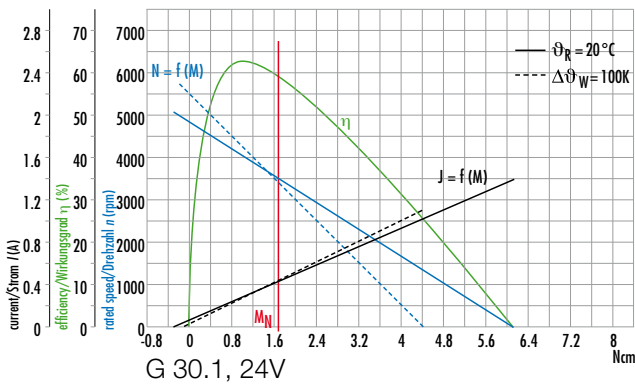
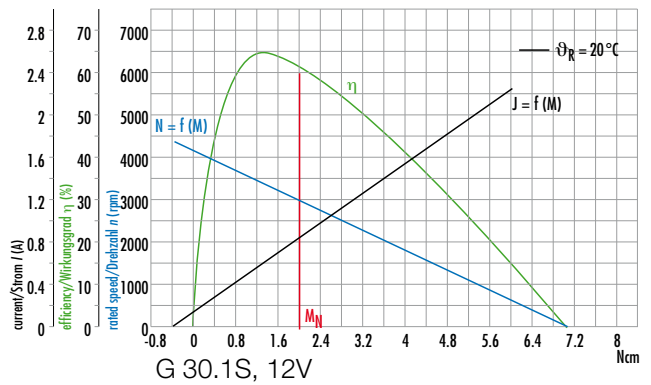
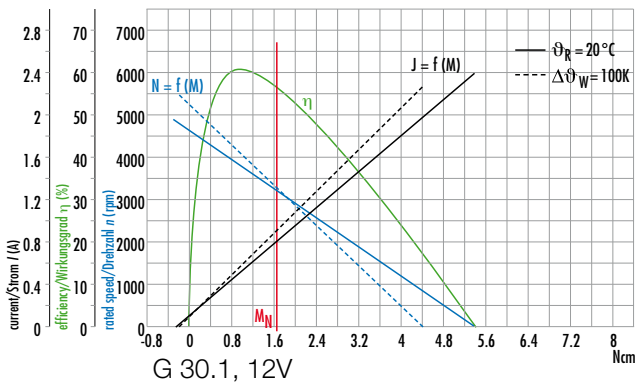

- » Mechanical commutation through multi bar commutator provides long lifetime
- » Operation in both directions of rotation
- » Ball bearing at motor output shaft is standard
- » Optionally with ball bearing on both sides, shaft on both sides, custom shaft length and diameter, lead version, special winding on request

- » Mechanische Kommutierung über vierteiligen Kollektor bietet lange Lebensdauer
- » Drehrichtung Rechts-/ Linkslauf
- » Motorwelle abtriebsseitig kugellagert ist Standard
- » Optional beidseitig kugellagert, beidseitige Welle, abweichende Wellenlängen und -durchmesser, Litzenausführung, Sonderwicklung auf Anfrage

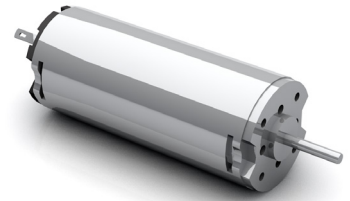





Supply voltage versions



High efficiency



Low noise



Protection class (up to)

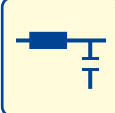

Interference suppression optional

Data/ Technische Daten		G 30.0			G 30.0S		
Nominal voltage/ Nennspannung	VDC	12	24	40	12	24	40
Nominal current/ Nennstrom	A <sup>*)</sup>	1.4	0.71	0.4	1.40	0.71	0.40
Nominal torque/ Nennmoment	Nm <sup>†)</sup>	0.03	0.03	0.03	0.0370	0.0370	0.0370
Nominal speed/ Nenn Drehzahl	rpm <sup>†)</sup>	2980	3030	2810	2500	2650	2600
Stall torque/ Anhaltmoment	Nm <sup>†)</sup>	0.129	0.13	0.123	0.153	0.17	0.165
Maximum torque/ Maximales Moment	Nm <sup>†)</sup>	0.129	0.13	0.123	0.153	0.17	0.165
No load speed/ Leerlaufdrehzahl	rpm <sup>†)</sup>	4130	4400	4100	3250	3550	3350
Nominal output power/ Dauerabgabeleistung	W <sup>†)</sup>	9.4	9.5	8.8	9.7	10.27	10.1
Maximum output power/ Maximale Abgabeleistung	W	13.93	14.9	13.2	13.02	15.8	14.9
Torque constant/ Drehmomentkonstante	Nm A <sup>-1†)</sup>	0.0288	0.05	0.0873	0.0336	0.0636	0.1102
Terminal Resistance/ Anschlusswiderstand	Ω	2.61	8.9	27.4	2.55	8.73	26.4
Terminal inductance/ Anschlussinduktivität	mH	2.61	8.0	24.7	2.61	7.42	24.7
Starting current/ Anlaufstrom	A <sup>†)</sup>	4.6	2.7	1.46	4.7	2.75	1.52
No load current/ Leerlaufstrom	A <sup>†)</sup>	0.25	0.13	0.07	0.25	0.14	0.075
Demagnetisation current/ Entmagnetisierungsstrom	A <sup>†)</sup>	≥ 11.5	≥ 6.0	≥ 3.0	0.0	0.0	0.0
Rotor inertia/ Rotor Trägheitsmoment	gcm <sup>2</sup>	42.2	41.9	42.2	42	41.9	42.2
Weight of motor/ Motorgewicht	kg	0.24	0.24	0.24	0.24	0.24	0.24

\*) Δθ<sub>w</sub> = 100 K; \*\*) θ<sub>a</sub> = 20°C \*\*\*) at nominal point/ im Nennpunkt   Preference/ Vorzugsreihe   On request/ auf Anfrage

### Modular System/ Modulares Baukastensystem

- » Brakes/ Bremsen
  - E 38
- » Encoder/ Geber
  - MG 2
  - RE 22
  - RE 30 (TI)

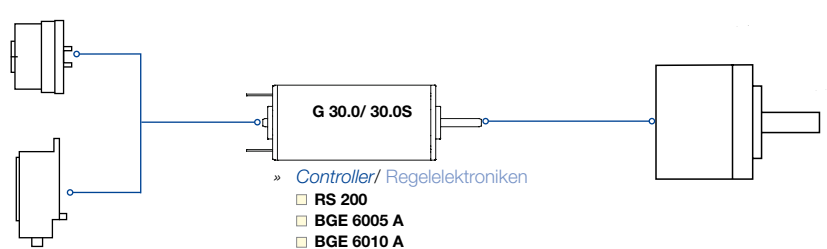

» Controller/ Regelelektroniken

- RS 200
- BGE 6005 A
- BGE 6010 A

- » Planetary Gearboxes/  
Planetengetriebe
  - PLG 30
  - PLG 30 H
  - PLG 32
  - PLG 42 K
  - PLG 42 S

You can individually configure your suitable product and download technical data and drawings for the combination at [www.dunkermotoren.com/en/configuration/](http://www.dunkermotoren.com/en/configuration/)  
 Unter [www.dunkermotoren.de/konfigurator](http://www.dunkermotoren.de/konfigurator) können Sie Ihr passendes Produkt individuell konfigurieren und technische Daten und Zeichnung für die Kombination herunterladen.

Dimensions in mm/ Maßzeichnung in mm

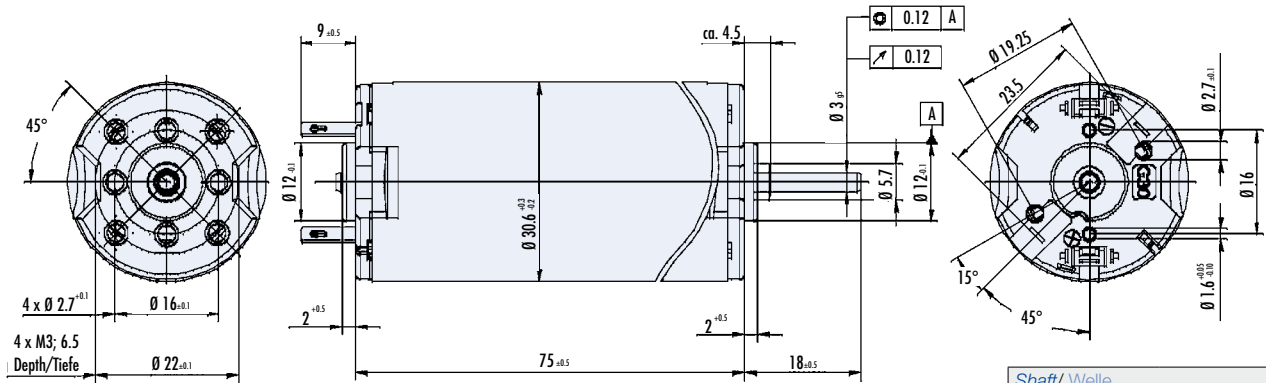

$F_{axial} = \text{max. } 10\text{N}$   
 $F_{radial} = \text{max. } 22\text{N}$

Shaft/ Welle	
front/ vorne	back/ hinten
3 x 18 mm	-
3 x 10 mm	-
3 x 10 mm	3 x 15 mm

Characteristic diagram/ Belastungskennlinien

In accordance with/ Belastungskennlinien gezeichnet nach EN 60034

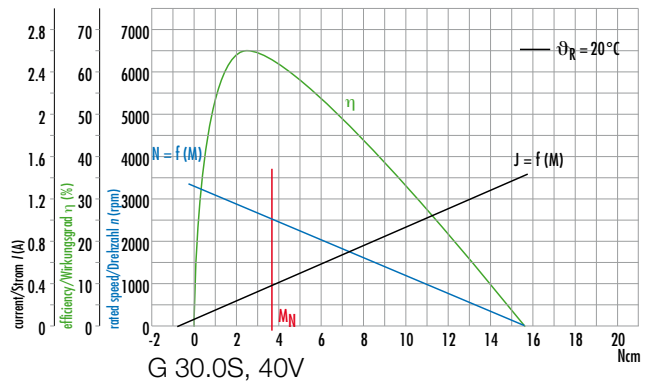
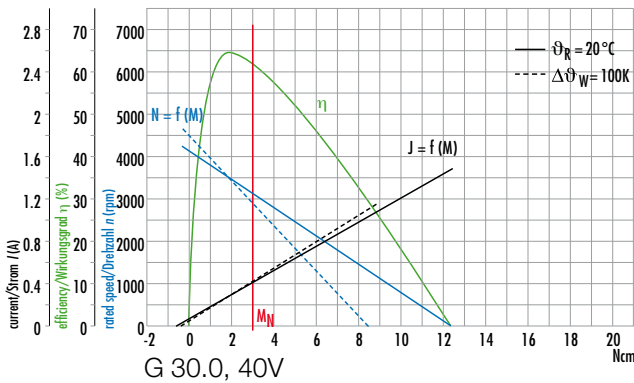
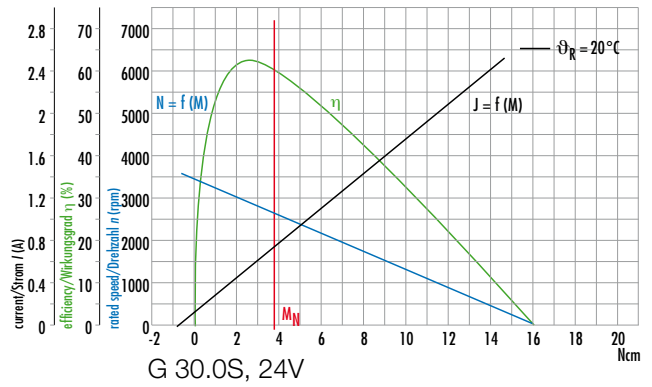
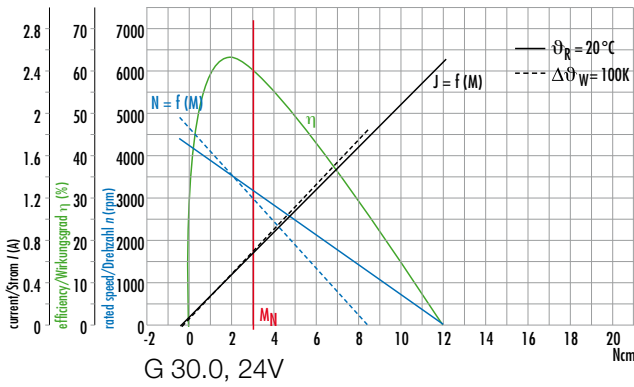
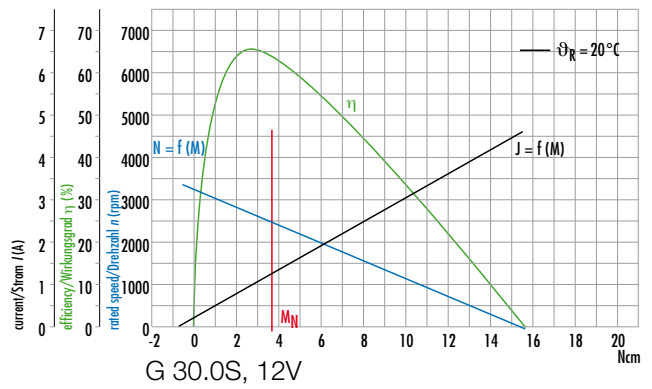
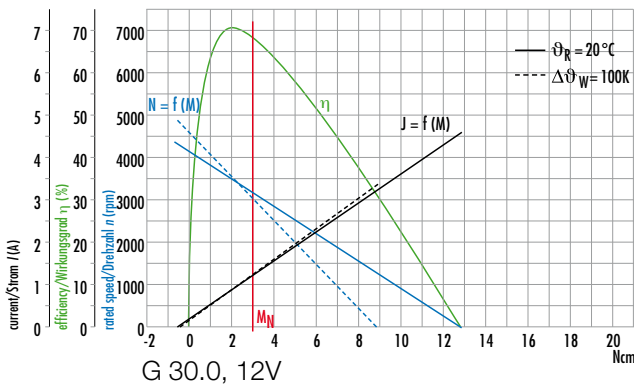



- » Mechanical commutation through multi bar commutator provides long lifetime
- » Operation in both directions of rotation
- » Ball bearing at motor output shaft is standard
- » Custom shaft length and diameter, shaft on both sides, special winding, higher protection class up to IP 67 on request

- » Mechanische Kommutierung über vierteiligen Kollektor bietet lange Lebensdauer
- » Drehrichtung Rechts-/ Linkslauf
- » Motorwelle abtriebsseitig kugellagert ist Standard
- » Abweichende Wellenlängen und -durchmesser, beidseitige Welle, Sonderwicklung, höhere Schutzart bis IP 67 auf Anfrage

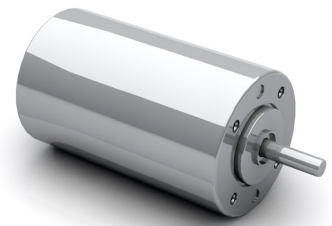

Supply voltage versions



High efficiency



Low noise



Special surface



Protection class

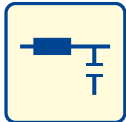

Interference suppression optional



Certification



Certification



Certification (>36 V only)

Data/ Technische Daten		GR 42x25		
Nominal voltage/ Nennspannung	VDC	12	24	40
Nominal current/ Nennstrom	A <sup>*)</sup>	1.9	0.86	0.55
Nominal torque/ Nennmoment	Nm <sup>*)</sup>	0.039	0.038	0.039
Nominal speed/ Nennzahl	rpm <sup>*)</sup>	3450	3600	3700
Stall torque/ Anhaltmoment	Nm <sup>**)</sup>	0.19	0.20	0.216
Maximum torque/ Maximales Moment	Nm <sup>**)</sup>	0.19	0.20	0.216
No load speed/ Leerlaufzahl	rpm <sup>*)</sup>	4350	4200	4400
Nominal output power/ Dauerabgabeleistung	W <sup>*)</sup>	14.1	14.3	15.1
Maximum output power/ Maximale Abgabeleistung	W	21.6	22.1	25
Torque constant/ Drehmomentkonstante	Nm A <sup>-1**)</sup>	0.0253	0.0514	0.081
Terminal Resistance/ Anschlusswiderstand	Ω	1.54	5.95	14.5
Terminal inductance/ Anschlussinduktivität	mH	1.8	8.9	18.9
Starting current/ Anlaufstrom	A <sup>*)</sup>	7.8	4	2.76
No load current/ Leerlaufstrom	A <sup>*)</sup>	0.34	0.17	0.11
Demagnetisation current/ Entmagnetisierungsstrom	A <sup>*)</sup>	≥ 14	≥ 6.5	≥ 4.1
Rotor inertia/ Rotor Trägheitsmoment	gcm <sup>2</sup>	71	71	71
Weight of motor/ Motorgewicht	kg	0.39	0.39	0.39

\*)  $\Delta\theta_w = 100\text{ K}$ ; \*\*)  $\theta_r = 20^\circ\text{C}$  (\*\*\*) at nominal point/ im Nennpunkt  Preference/ Vorzugsreihe  On request/ auf Anfrage

## Modular System/ Modulares Baukastensystem

- » Brakes/ Bremsen
  - E 38
- » Encoder/ Geber
  - MG 2
  - ME 52
  - RE 20
  - RE 30 (TI)
  - RE 56 (TI)

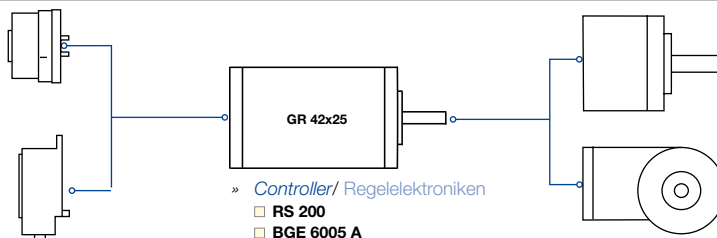

- » Planetary Gearboxes/  
Planetengetriebe
  - PLG 32
  - PLG 42 K
  - PLG 42 S
  - PLG 52
- » Angular Gearboxes/  
Winkelgetriebe
  - SG 45
  - SG 62

- » Controller/ Regelelektroniken
  - RS 200
  - BGE 6005 A
  - BGE 6010 A
  - BGE 5510 dPro

- » Accessories/ Zubehör
  - Cover IP54 / Schutzhaube IP54

You can individually configure your suitable product and download technical data and drawings for the combination at [www.dunkermotoren.com/en/configuration/](http://www.dunkermotoren.com/en/configuration/).  
Unter [www.dunkermotoren.de/konfigurator](http://www.dunkermotoren.de/konfigurator) können Sie Ihr passendes Produkt individuell konfigurieren und technische Daten und Zeichnung für die Kombination herunterladen.

Dimensions in mm/ Maßzeichnung in mm

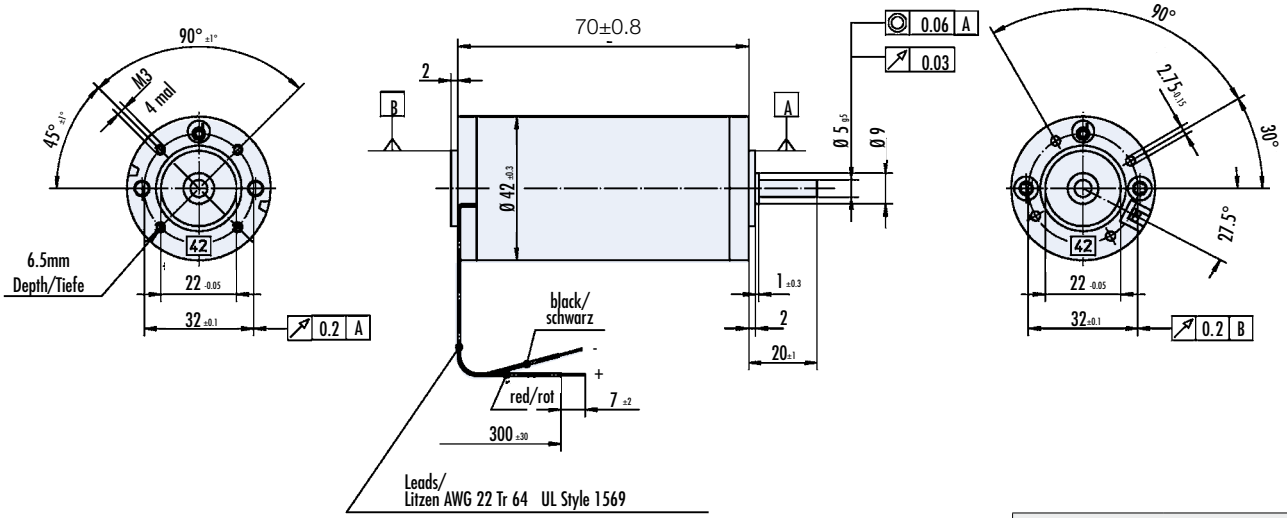

F<sub>axial</sub> = max. 30N  
F<sub>radial</sub> = max. 60N

Shaft/ Welle	
front/ vorne	back/ hinten
5 x 20 mm	-
5 x 45 mm	-
5 x 45 mm	5 x 45 mm

Characteristic diagram/ Belastungskennlinien

In accordance with/ Belastungskennlinien gezeichnet nach EN 60034

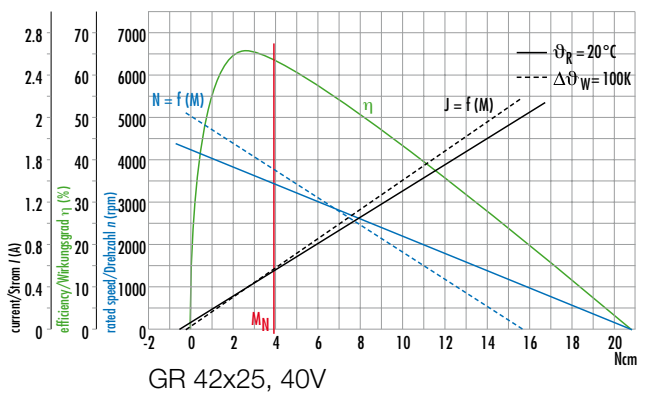
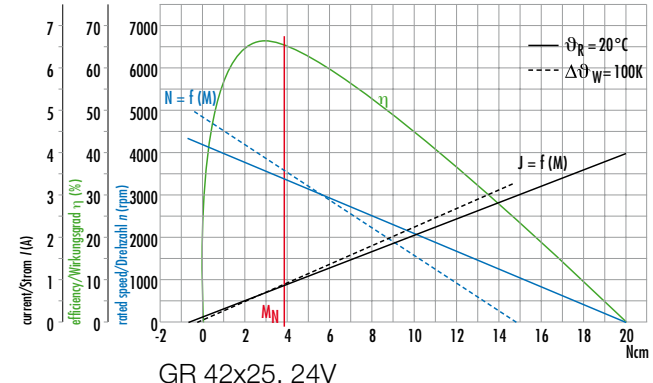
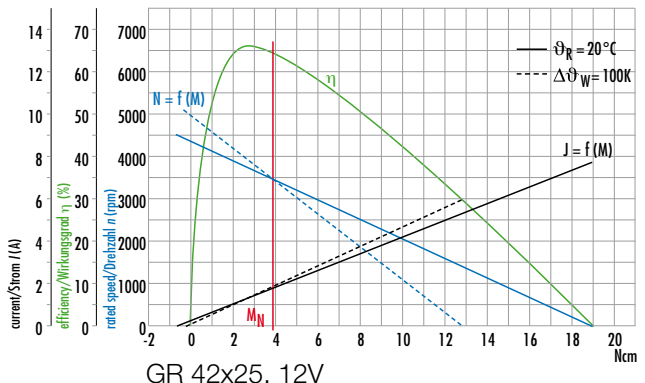

## GR 42x40 | cont. 21 W, peak 38 W

- » Mechanical commutation through multi bar commutator provides long lifetime
- » Operation in both directions of rotation
- » Ball bearing at motor output shaft is standard
- » Custom shaft length and diameter, shaft on both sides, special winding, higher protection class up to IP 67 on request

- » Mechanische Kommutierung über vierteiligen Kollektor bietet lange Lebensdauer
- » Drehrichtung Rechts-/ Linkslauf
- » Motorwelle abtriebsseitig kugellagert ist Standard
- » Abweichende Wellenlängen und -durchmesser, beidseitige Welle, Sonderwicklung, höhere Schutzart bis IP 67 auf Anfrage

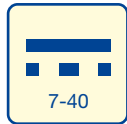
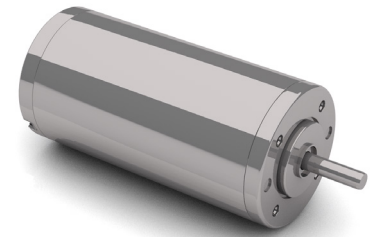

Supply voltage versions



High efficiency



Low noise



Special surface



Protection class

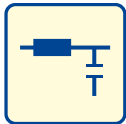

Interference suppression optional



Certification



Certification



Certification (>36 V only)

Data/ Technische Daten		GR 42x40		
Nominal voltage/ Nennspannung	VDC	12	24	40
Nominal current/ Nennstrom	A <sup>*)</sup>	2.7	1.2	0.8
Nominal torque/ Nennmoment	Nm <sup>*)</sup>	0.053	0.057	0.057
Nominal speed/ Nenn Drehzahl	rpm <sup>*)</sup>	3750	3100	3400
Stall torque/ Anhaltmoment	Nm <sup>**)</sup>	0.319	0.33	0.356
Maximum torque/ Maximales Moment	Nm <sup>**)</sup>	0.319	0.33	0.356
No load speed/ Leerlauf Drehzahl	rpm <sup>*)</sup>	4550	3800	3950
Nominal output power/ Dauerabgabeleistung	W <sup>*)</sup>	20.8	18.5	20.3
Maximum output power/ Maximale Abgabeleistung	W <sup>*)</sup>	37.95	32.3	36.6
Torque constant/ Drehmomentkonstante	Nm A <sup>-1**)</sup>	0.0247	0.0584	0.0913
Terminal Resistance/ Anschlusswiderstand	Ω	0.91	4.2	10.1
Terminal inductance/ Anschlussinduktivität	mH	1	5.1	15.7
Starting current/ Anlaufstrom	A <sup>*)</sup>	13.2	5.68	3.97
No load current/ Leerlaufstrom	A <sup>*)</sup>	0.44	0.18	0.12
Demagnetisation current/ Entmagnetisierungsstrom	A <sup>*)</sup>	≥ 24	≥ 10.5	≥ 6.3
Rotor inertia/ Rotor Trägheitsmoment	gcm <sup>2</sup>	110	110	110
Weight of motor/ Motorgewicht	kg	0.49	0.49	0.49

\*)  $\Delta\theta_w = 100\text{ K}$ ; \*\*)  $\vartheta_R = 20^\circ\text{C}$  \*\*) at nominal point/ im Nennpunkt  Preference/ Vorzugsreihe  On request/ auf Anfrage

### Modular System/ Modulares Baukastensystem

- » Brakes/ Bremsen
  - E 38

- » Encoder/ Geber
  - MG 2
  - ME 52
  - RE 20
  - RE 30 (T1)
  - RE 56 (T1)

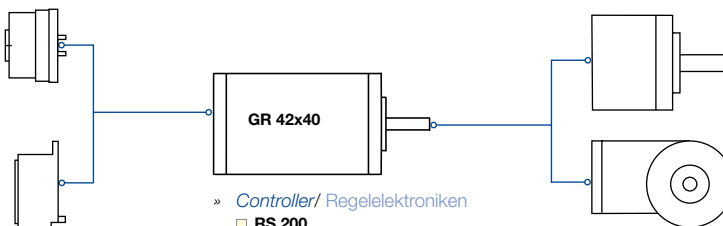

- » Controller/ Regelelektroniken
  - RS 200
  - BGE 6005 A
  - BGE 6010 A
  - BGE 5510 dPro

- » Accessories/ Zubehör
  - Cover IP54 / Schutzhaube IP54

- » Planetary Gearboxes/  
Planetengetriebe
  - PLG 32
  - PLG 42 K
  - PLG 42 S
  - PLG 52
- » Angular Gearboxes/  
Winkelgetriebe
  - SG 45
  - SG 62

You can individually configure your suitable product and download technical data and drawings for the combination at [www.dunkermotoren.com/en/configuration/](http://www.dunkermotoren.com/en/configuration/)  
 Unter [www.dunkermotoren.de/konfigurator](http://www.dunkermotoren.de/konfigurator) können Sie Ihr passendes Produkt individuell konfigurieren und technische Daten und Zeichnung für die Kombination herunterladen.



- » Operation in both directions of rotation
- » Ball bearing at motor output shaft is standard
- » With custom shaft length and diameter, shaft on both sides, special winding, higher protection class up to IP 67 on request
- » Reinforced bearing with motor shaft  $\varnothing 8$  mm available

- » Drehrichtung Rechts-/ Linkslauf
- » Motorwelle abtriebsseitig kugellagert ist Standard
- » Abweichende Wellenlängen und -durchmesser, beidseitige Welle, Sonderwicklung, höhere Schutzart bis IP 67 auf Anfrage
- » Verstärkte Lagerung mit Welle  $\varnothing 8$  mm erhältlich

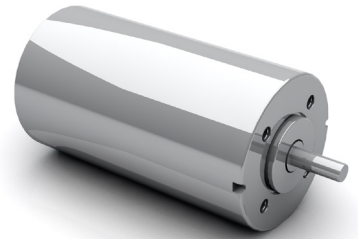

Supply voltage versions	High efficiency	Low noise	Special surface	Protection class	Interference suppression optional	Certification	Certification	Certification (>36 V only)

Data/ Technische Daten		GR 53x30			
Nominal voltage/ Nennspannung	VDC	12	24	40	60
Nominal current/ Nennstrom	A <sup>*)</sup>	4.5	2.3	1.3	0.9
Nominal torque/ Nennmoment	Nm <sup>*)</sup>	0.09	0.1	0.096	0.096
Nominal speed/ Nenn Drehzahl	rpm <sup>*)</sup>	3790	3600	3680	4000
Stall torque/ Anhaltmoment	Nm <sup>**)</sup>	0.57	0.67	0.66	0.69
Maximum torque/ Maximales Moment	Nm <sup>**)</sup>	0.57	0.67	0.66	0.69
No load speed/ Leerlauf Drehzahl	rpm <sup>*)</sup>	4490	4200	4280	4500
Nominal output power/ Dauerabgabeleistung	W <sup>*)</sup>	35.7	37.7	37	39.2
Maximum output power/ Maximale Abgabeleistung	W	67.5	73.8	73.7	81.3
Torque constant/ Drehmomentkonstante	Nm A <sup>-1**)</sup>	0.0247	0.0506	0.0875	0.1254
Terminal Resistance/ Anschlusswiderstand	$\Omega$	0.51	1.77	5.22	10.6
Terminal inductance/ Anschlussinduktivität	mH	0.97	3.6	10.9	22.3
Starting current/ Anlaufstrom	A <sup>*)</sup>	23.7	13.5	7.7	5.6
No load current/ Leerlaufstrom	A <sup>*)</sup>	0.58	0.28	0.17	0.12
Demagnetisation current/ Entmagnetisierungsstrom	A <sup>*)</sup>	$\geq 42$	$\geq 20$	$\geq 12$	$\geq 8.5$
Rotor inertia/ Rotor Trägheitsmoment	gcm <sup>2</sup>	233	229	227	227
Weight of motor/ Motorgewicht	kg	0.85	0.85	0.85	0.85

\*)  $\Delta\theta_w = 100$  K; \*\*)  $\theta_R = 20^\circ\text{C}$  (\*\*\*) at nominal point/ im Nennpunkt  Preference/ Vorzugsreihe  On request/ auf Anfrage

### Modular System/ Modulares Baukastensystem

<ul style="list-style-type: none"> <li>» Brakes/ Bremsen                             <ul style="list-style-type: none"> <li><input type="checkbox"/> E 46</li> <li><input type="checkbox"/> E 90</li> <li><input type="checkbox"/> E 100</li> </ul> </li> <li>» Encoder/ Geber                             <ul style="list-style-type: none"> <li><input type="checkbox"/> ME 52</li> <li><input type="checkbox"/> RE 20</li> <li><input type="checkbox"/> RE 30 (TI)</li> <li><input type="checkbox"/> RE 56 (TI)</li> </ul> </li> </ul>		<ul style="list-style-type: none"> <li>» Planetary Gearboxes/ Planetengetriebe                             <ul style="list-style-type: none"> <li><input type="checkbox"/> PLG 42 S</li> <li><input type="checkbox"/> PLG 52</li> <li><input type="checkbox"/> PLG 52 H</li> </ul> </li> <li>» Angular Gearboxes/ Winkelgetriebe                             <ul style="list-style-type: none"> <li><input type="checkbox"/> SG 62</li> <li><input type="checkbox"/> SG 65</li> <li><input type="checkbox"/> SG 80</li> <li><input type="checkbox"/> SG 85</li> <li><input type="checkbox"/> KG 90</li> </ul> </li> </ul>
<ul style="list-style-type: none"> <li>» Controller/ Regelelektroniken                             <ul style="list-style-type: none"> <li><input type="checkbox"/> RS 200</li> <li><input type="checkbox"/> BGE 5510 dPro</li> <li><input type="checkbox"/> BGE 6005 A</li> <li><input type="checkbox"/> BGE 6010 A</li> </ul> </li> <li>» Accessories/ Zubehör                             <ul style="list-style-type: none"> <li><input type="checkbox"/> Cover IP54 / Schutzhaube IP54</li> </ul> </li> </ul>		

You can individually configure your suitable product and download technical data and drawings for the combination at [www.dunkermotoren.com/en/configuration/](http://www.dunkermotoren.com/en/configuration/)  
 Unter [www.dunkermotoren.de/konfigurator](http://www.dunkermotoren.de/konfigurator) können Sie Ihr passendes Produkt individuell konfigurieren und technische Daten und Zeichnung für die Kombination herunterladen.

Dimensions in mm/ Maßzeichnung in mm

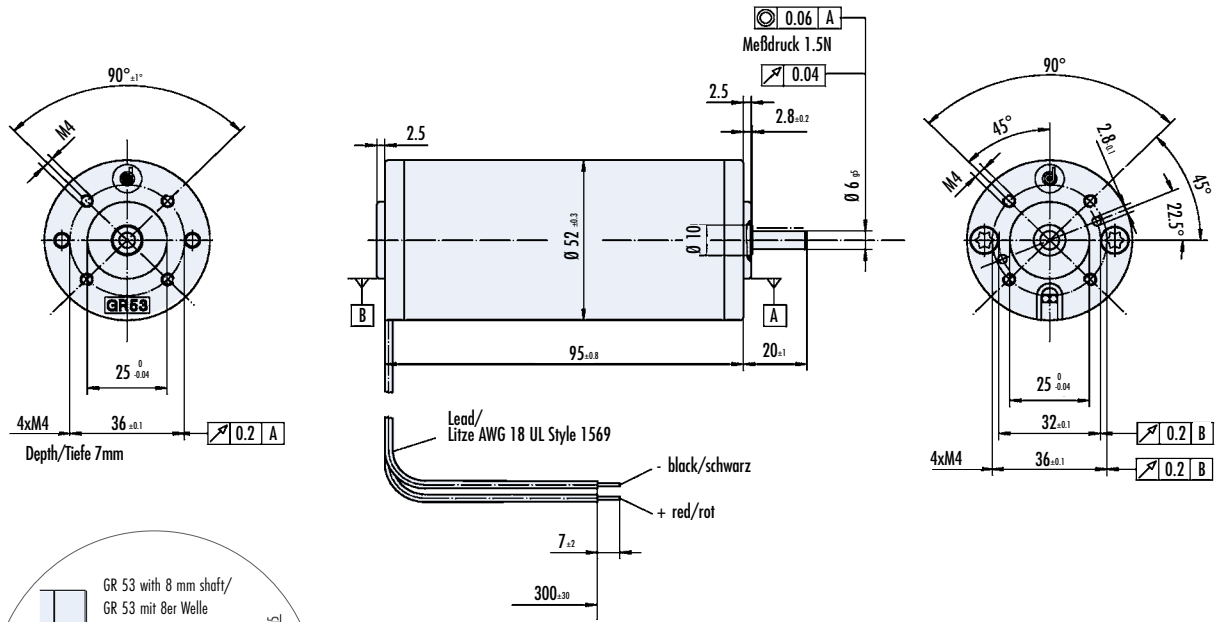

F<sub>axial</sub> = max. 130N  
F<sub>radial</sub> = max. 90N

Shaft/ Welle	
front/ vorne	back/ hinten
6 x 20 mm	-
6 x 45 mm	6 x 54.5 mm
8 x 55 mm	6 x 54.5 mm

Characteristic diagram/ Belastungskennlinien

In accordance with/ Belastungskennlinien gezeichnet nach EN 60034

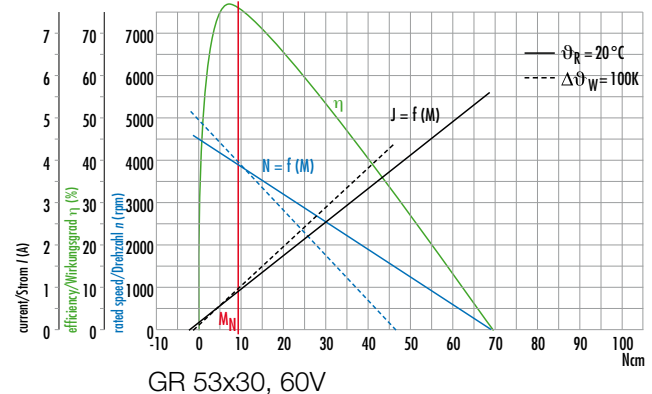
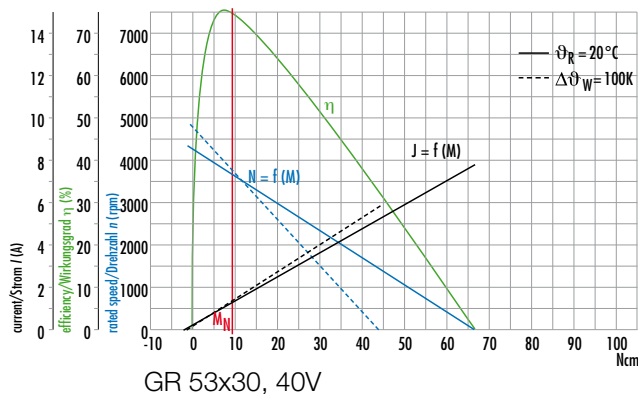
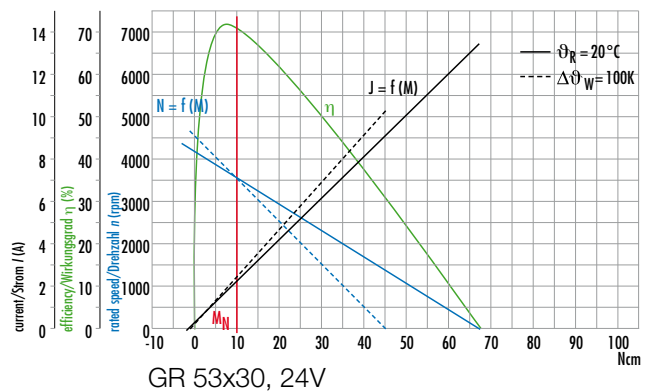
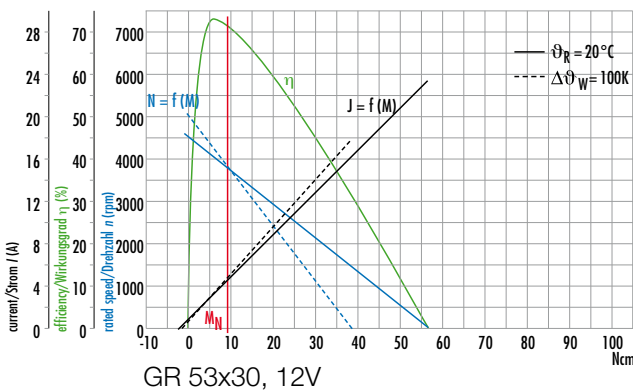

## >> GR 53x58 | cont. 61 W, peak 136 W

- » Operation in both directions of rotation
- » Ball bearing at motor output shaft is standard
- » With custom shaft length and diameter, shaft on both sides, special winding, higher protection class up to IP 67 on request
- » Reinforced bearing with motor shaft  $\varnothing 8$  mm available

- » Drehrichtung Rechts-/ Linkslauf
- » Motorwelle abtriebsseitig kugellagert ist Standard
- » Abweichende Wellenlängen und -durchmesser, beidseitige Welle, Sonderwicklung, höhere Schutzart bis IP 67 auf Anfrage
- » Verstärkte Lagerung mit Welle  $\varnothing 8$  mm erhältlich

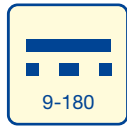
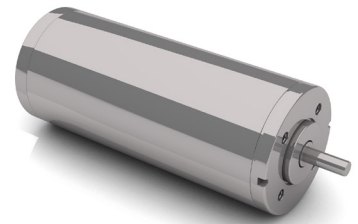

Supply voltage versions



High efficiency



Low noise



Special surface



Protection class

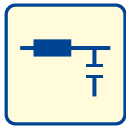

Interference suppression optional



Certification



Certification



Certification (>36 V only)

Data/ Technische Daten		GR 53x58			
Nominal voltage/ Nennspannung	VDC	12	24	40	60
Nominal current/ Nennstrom	A <sup>*)</sup>	5.5	2.9	1.9	1.3
Nominal torque/ Nennmoment	Nm <sup>*)</sup>	0.155	0.17	0.17	0.17
Nominal speed/ Nennzahl	rpm <sup>*)</sup>	3000	3000	3300	3450
Stall torque/ Anhaltmoment	Nm <sup>**)</sup>	1.14	1.43	1.39	1.44
Maximum torque/ Maximales Moment	Nm <sup>**)</sup>	1.14	1.43	1.39	1.44
No load speed/ Leerlaufdrehzahl	rpm <sup>*)</sup>	3200	3250	3450	3600
Nominal output power/ Dauerabgabeleistung	W <sup>*)</sup>	48.7	53.4	58.7	61.4
Maximum output power/ Maximale Abgabeleistung	W	96	121	125	136
Torque constant/ Drehmomentkonstante	Nm A <sup>-1**)</sup>	0.032	0.0697	0.096	0.14
Terminal Resistance/ Anschlusswiderstand	$\Omega$	0.34	1.15	2.78	5.8
Terminal inductance/ Anschlussinduktivität	mH	1.5	4.7	12.5	26.1
Starting current/ Anlaufstrom	A <sup>*)</sup>	35.3	20.8	14.4	10.3
No load current/ Leerlaufstrom	A <sup>*)</sup>	0.44	0.22	0.135	0.1
Demagnetisation current/ Entmagnetisierungsstrom	A <sup>*)</sup>	$\geq 61$	$\geq 31$	$\geq 20$	$\geq 13.5$
Rotor inertia/ Rotor Trägheitsmoment	gcm <sup>2</sup>	460	460	460	460
Weight of motor/ Motorgewicht	kg	1.16	1.16	1.16	1.16

\*)  $\Delta\theta_w = 100$  K; \*\*)  $\theta_r = 20^\circ\text{C}$  \*\*\*) at nominal point/ im Nennpunkt  Preference/ Vorzugsreihe  On request/ auf Anfrage

### Modular System/ Modulares Baukastensystem

#### » Brakes/ Bremsen

- E 46
- E 90
- E 100

#### » Encoder/ Geber

- ME 52
- RE 20
- RE 30 (TI)
- RE 56 (TI)

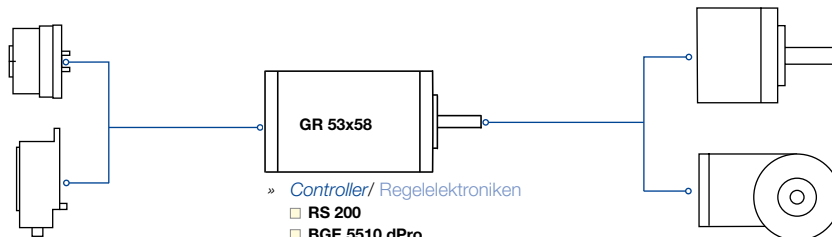

#### » Planetary Gearboxes/ Planetengetriebe

- PLG 42 S
- PLG 52
- PLG 52 H

#### » Angular Gearboxes/ Winkelgetriebe

- SG 62
- SG 65
- SG 80
- SG 85
- KG 90

#### » Controller/ Regelelektroniken

- RS 200
- BGE 5510 dPro
- BGE 6005 A
- BGE 6010 A

#### » Accessories/ Zubehör

- Cover IP54 / Schutzhaube IP54

You can individually configure your suitable product and download technical data and drawings for the combination at [www.dunkermotoren.com/en/configuration/](http://www.dunkermotoren.com/en/configuration/)

Unter [www.dunkermotoren.de/konfigurator](http://www.dunkermotoren.de/konfigurator) können Sie Ihr passendes Produkt individuell konfigurieren und technische Daten und Zeichnung für die Kombination herunterladen.

Dimensions in mm/ Maßzeichnung in mm

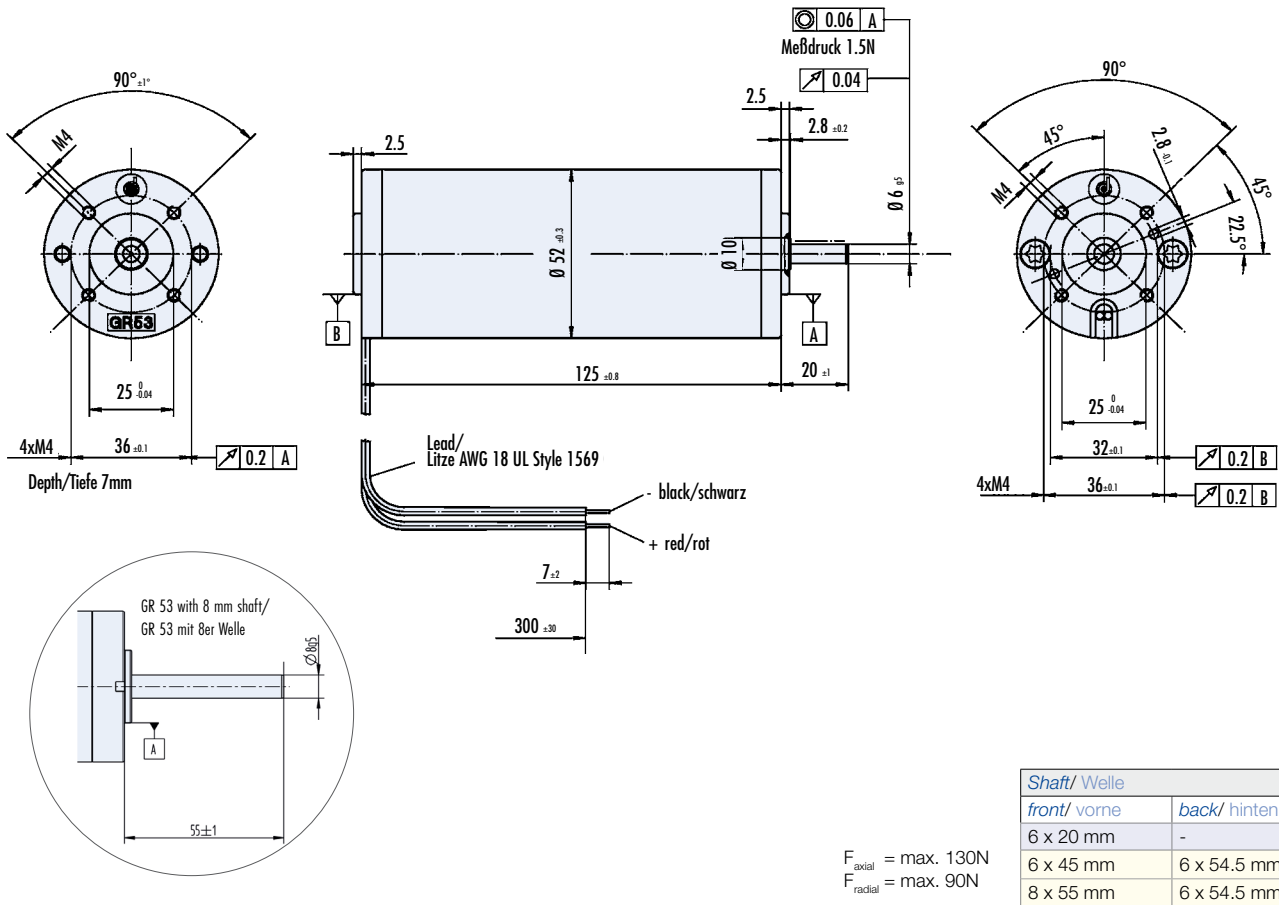

Characteristic diagram/ Belastungskennlinien

In accordance with/ Belastungskennlinien gezeichnet nach EN 60034

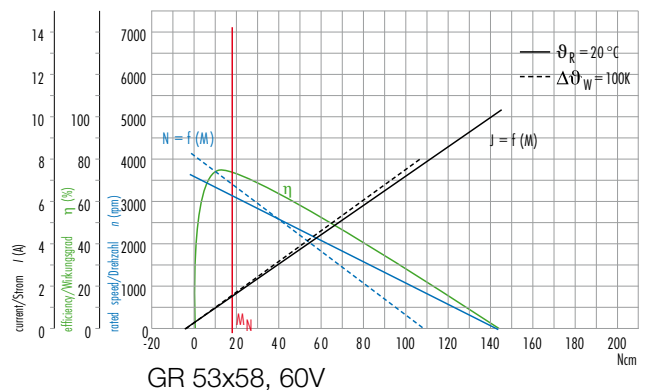
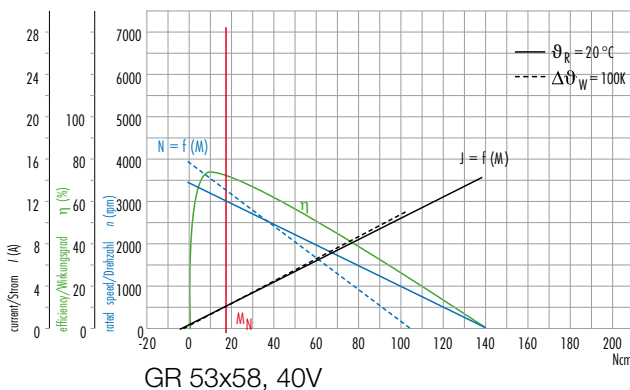
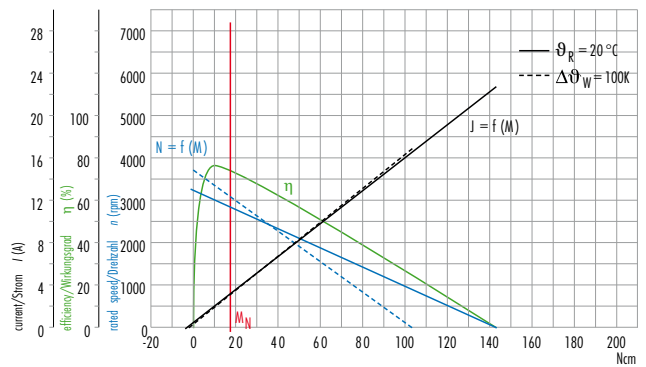
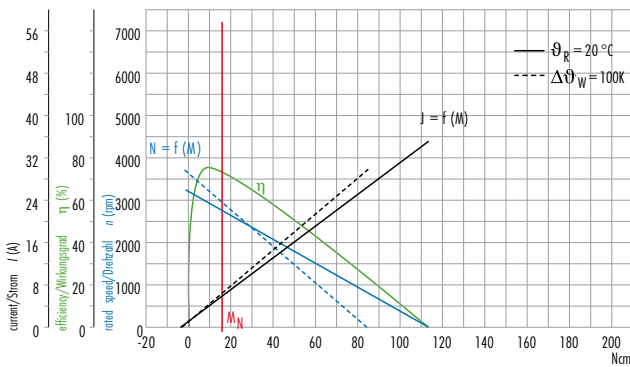



- » Operation in both directions of rotation
- » Ball bearing at motor output shaft is standard
- » With custom shaft length and diameter, shaft on both sides, special and high voltage winding, higher protection class up to IP 67, reinforced bearing on request

- » Drehrichtung Rechts-/ Linkslauf
- » Motorwelle abtriebsseitig kugellagert ist Standard
- » Abweichende Wellenlängen und -durchmesser, beidseitige Welle, Sonder- und Hochspannungswicklungen, höhere Schutzart bis IP 67, verstärkte Lagerung auf Anfrage

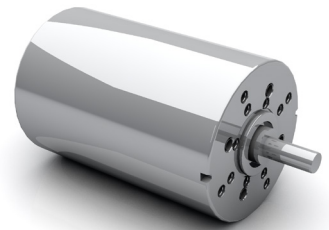

Supply voltage versions	High efficiency	Low noise	Special surface	Protection class	Interference suppression optional	Certification	Certification	Certification (>36 V only)

Data/ Technische Daten		GR 63x25			
Nominal voltage/ Nennspannung	VDC	12	24	40	60
Nominal current/ Nennstrom	A <sup>*)</sup>	5.2	2.7	1.65	1.1
Nominal torque/ Nennmoment	Nm <sup>*)</sup>	0.137	0.14	0.133	0.145
Nominal speed/ Nenndrehzahl	rpm <sup>*)</sup>	3100	3300	3500	3300
Stall torque/ Anhaltmoment	Nm <sup>**)</sup>	1.05	1.08	1.18	1.16
Maximum torque/ Maximales Moment	Nm <sup>**)</sup>	1.05	1.08	1.18	1.16
No load speed/ Leerlaufdrehzahl	rpm <sup>*)</sup>	3600	3600	3800	3600
Nominal output power/ Dauerabgabeleistung	W <sup>*)</sup>	44.5	48.4	48.7	50
Maximum output power/ Maximale Abgabeleistung	W	99	101.8	117.4	119.3
Torque constant/ Drehmomentkonstante	Nm A <sup>-1**)</sup>	0.0313	0.06	0.098	0.153
Terminal Resistance/ Anschlusswiderstand	Ω	0.353	1.33	3.33	7.89
Terminal inductance/ Anschlussinduktivität	mH	1	2.9	7.3	17.4
Starting current/ Anlaufstrom	A <sup>*)</sup>	34	18	12	7.6
No load current/ Leerlaufstrom	A <sup>*)</sup>	0.750	0.36	0.205	0.135
Demagnetisation current/ Entmagnetisierungsstrom	A <sup>*)</sup>	≥ 50	≥ 24	≥ 16	≥ 9.5
Rotor inertia/ Rotor Trägheitsmoment	gcm <sup>2</sup>	400	400	400	400
Weight of motor/ Motorgewicht	kg	1.2	1.2	1.2	1.2

\*) Δθ<sub>w</sub> = 100 K; \*\*) θ<sub>r</sub> = 20°C \*\*\*) at nominal point/ im Nennpunkt  Preference/ Vorzugsreihe  On request/ auf Anfrage

Modular System/ Modulares Baukastensystem

<ul style="list-style-type: none"> <li>» Brakes/ Bremsen <ul style="list-style-type: none"> <li><input type="checkbox"/> E 46</li> <li><input type="checkbox"/> E 90</li> <li><input type="checkbox"/> E 100</li> </ul> </li> <li>» Encoder/ Geber <ul style="list-style-type: none"> <li><input type="checkbox"/> ME 52</li> <li><input type="checkbox"/> RE 20</li> <li><input type="checkbox"/> RE 30 (TI)</li> <li><input type="checkbox"/> RE 56 (TI)</li> </ul> </li> </ul>		<ul style="list-style-type: none"> <li>» Planetary Gearboxes/ Planetengetriebe <ul style="list-style-type: none"> <li><input type="checkbox"/> PLG 52</li> <li><input type="checkbox"/> PLG 52 H</li> <li><input type="checkbox"/> PLG 60</li> <li><input type="checkbox"/> PLG 63</li> <li><input type="checkbox"/> PLG 63</li> <li><input type="checkbox"/> PLG 75</li> </ul> </li> <li>» Angular Gearboxes/ Winkelgetriebe <ul style="list-style-type: none"> <li><input type="checkbox"/> KG 90</li> <li><input type="checkbox"/> SG65</li> <li><input type="checkbox"/> SG 80</li> <li><input type="checkbox"/> SG 85</li> <li><input type="checkbox"/> SG 120</li> <li><input type="checkbox"/> STG 65</li> </ul> </li> </ul>
<p>GR 63x25</p> <ul style="list-style-type: none"> <li>» Controller/ Regelelektroniken <ul style="list-style-type: none"> <li><input type="checkbox"/> RS 200</li> <li><input type="checkbox"/> BGE 5510 dPro</li> <li><input type="checkbox"/> BGE 6005 A</li> <li><input type="checkbox"/> BGE 6010 A</li> </ul> </li> <li>» Accessories/ Zubehör <ul style="list-style-type: none"> <li><input type="checkbox"/> Cover IP54 / Schutzhaube IP54</li> </ul> </li> </ul>		
<p>You can individually configure your suitable product and download technical data and drawings for the combination at <a href="http://www.dunkermotoren.com/en/configuration/">www.dunkermotoren.com/en/configuration/</a>  Unter <a href="http://www.dunkermotoren.de/konfigurator">www.dunkermotoren.de/konfigurator</a> können Sie Ihr passendes Produkt individuell konfigurieren und technische Daten und Zeichnung für die Kombination herunterladen.</p>		

Dimensions in mm/ Maßzeichnung in mm

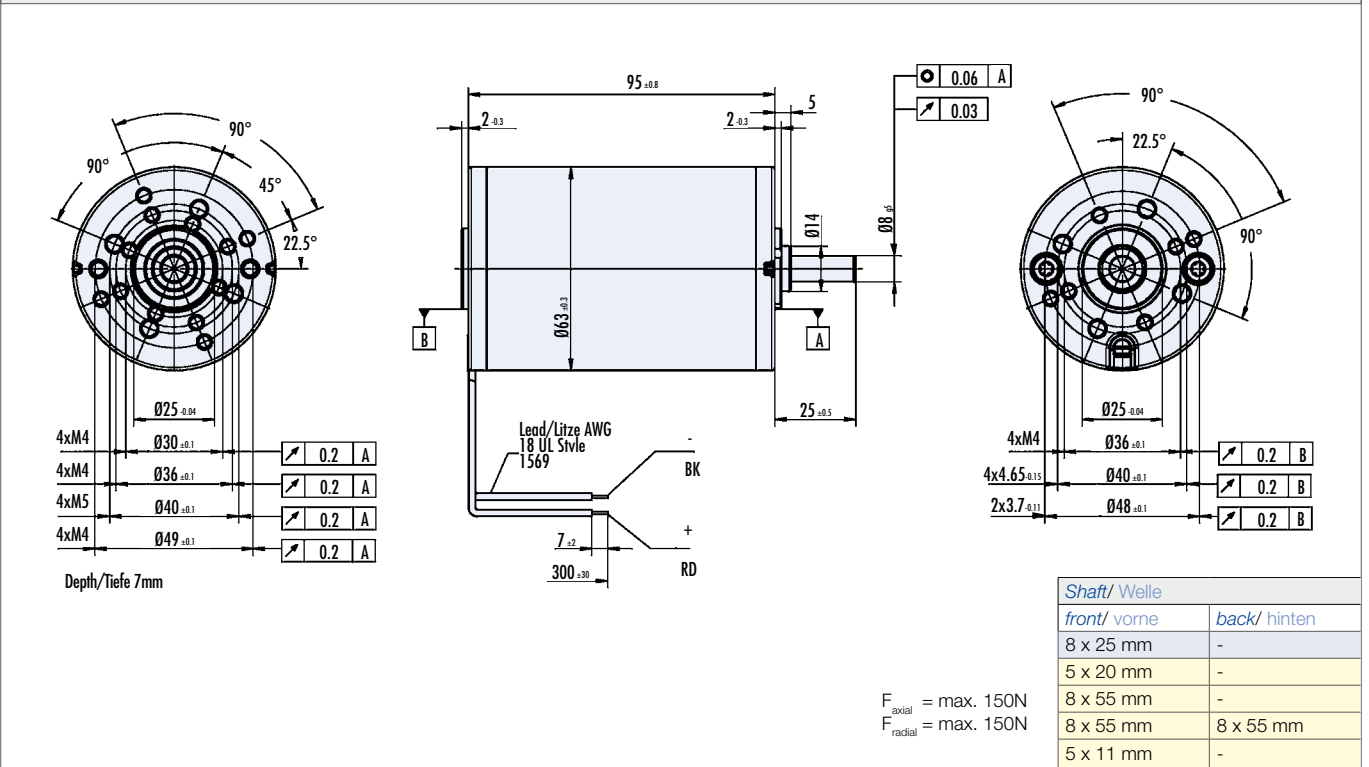

Characteristic diagram/ Belastungskennlinien

In accordance with/ Belastungskennlinien gezeichnet nach EN 60034

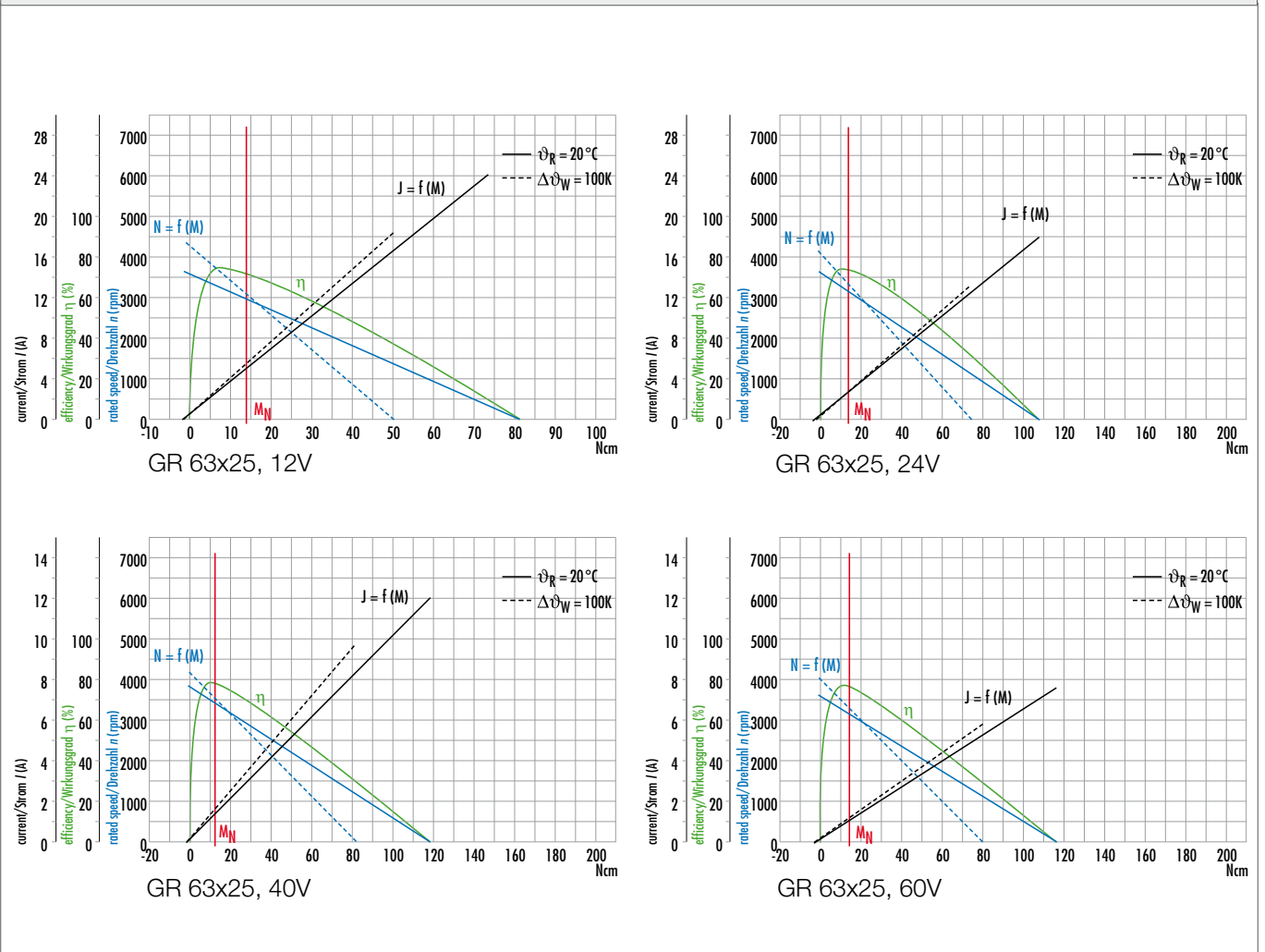

- » Operation in both directions of rotation
- » Ball bearing at motor output shaft is standard
- » With custom shaft length and diameter, shaft on both sides, special and high voltage winding, higher protection class up to IP 67, reinforced bearing on request

- » Drehrichtung Rechts-/ Linkslauf
- » Motorwelle abtriebsseitig kugellagert ist Standard
- » Abweichende Wellenlängen und -durchmesser, beidseitige Welle, Sonder- und Hochspannungswicklungen, höhere Schutzart bis IP 67, verstärkte Lagerung auf Anfrage

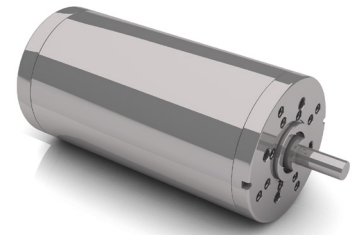

Supply voltage versions	High efficiency	Low noise	Special surface	Protection class	Interference suppression optional	Certification	Certification	Certification (>36 V only)

Data/ Technische Daten		GR 63x55			
Nominal voltage/ Nennspannung	VDC	12	24	40	60
Nominal current/ Nennstrom	A <sup>*)</sup>	8.7	4.9	2,95	2
Nominal torque/ Nennmoment	Nm <sup>*)</sup>	0.24	0.27	0.27	0.283
Nominal speed/ Nenn Drehzahl	rpm <sup>*)</sup>	3000	3350	3450	3350
Stall torque/ Anhaltmoment	Nm <sup>**)</sup>	1.45	2.57	3.01	3.04
Maximum torque/ Maximales Moment	Nm <sup>**)</sup>	1.45	2.57	3.01	3.04
No load speed/ Leerauf Drehzahl	rpm <sup>*)</sup>	3500	3650	3600	3600
Nominal output power/ Dauerabgabeleistung	W <sup>*)</sup>	75.4	94.7	97.5	99.3
Maximum output power/ Maximale Abgabeleistung	W	133	245	282.7	285.6
Torque constant/ Drehmomentkonstante	Nm A <sup>-1**)</sup>	0.0306	0.064	0.105	0.154
Terminal Resistance/ Anschlusswiderstand	Ω	0.25	0.6	1.4	3.05
Terminal inductance/ Anschlussinduktivität	mH	0.6	1.5	3.5	7.6
Starting current/ Anlaufstrom	A <sup>*)</sup>	48	40	28.6	19.7
No load current/ Leeraufstrom	A <sup>*)</sup>	0.9	0.4	0.28	0.2
Demagnetisation current/ Entmagnetisierungsstrom	A <sup>*)</sup>	≥ 66	≥ 33	≥ 20	≥ 13
Rotor inertia/ Rotor Trägheitsmoment	gcm <sup>2</sup>	750	750	750	750
Weight of motor/ Motorgewicht	kg	1.7	1.7	1.7	1.7

\*) Δθ<sub>w</sub> = 100 K; \*\*) θ<sub>n</sub> = 20°C \*\*\*) at nominal point/ im Nennpunkt  Preference/ Vorzugsreihe  On request/ auf Anfrage

Modular System/ Modulares Baukastensystem

<ul style="list-style-type: none"> <li>» Brakes/ Bremsen                             <ul style="list-style-type: none"> <li><input type="checkbox"/> E 46</li> <li><input type="checkbox"/> E 90</li> <li><input type="checkbox"/> E 100</li> </ul> </li> <li>» Encoder/ Geber                             <ul style="list-style-type: none"> <li><input type="checkbox"/> ME 52</li> <li><input type="checkbox"/> RE 20</li> <li><input type="checkbox"/> RE 30 (TI)</li> <li><input type="checkbox"/> RE 56 (TI)</li> </ul> </li> </ul>		<ul style="list-style-type: none"> <li>» Planetary Gearboxes/ Planetengetriebe                             <ul style="list-style-type: none"> <li><input type="checkbox"/> PLG 52</li> <li><input type="checkbox"/> PLG 52 H</li> <li><input type="checkbox"/> PLG 60</li> <li><input type="checkbox"/> PLG 63</li> <li><input type="checkbox"/> PLG 63</li> <li><input type="checkbox"/> PLG 75</li> </ul> </li> <li>» Angular Gearboxes/ Winkelgetriebe                             <ul style="list-style-type: none"> <li><input type="checkbox"/> KG 90</li> <li><input type="checkbox"/> SG 65</li> <li><input type="checkbox"/> SG 80</li> <li><input type="checkbox"/> SG 85</li> <li><input type="checkbox"/> SG 120</li> <li><input type="checkbox"/> STG 65</li> </ul> </li> </ul>
<p>» Controller/ Regelelektroniken</p> <ul style="list-style-type: none"> <li><input type="checkbox"/> RS 200</li> <li><input type="checkbox"/> BGE 5510 dPro</li> <li><input type="checkbox"/> BGE 6005 A</li> <li><input type="checkbox"/> BGE 6010 A</li> </ul> <p>» Accessories/ Zubehör</p> <ul style="list-style-type: none"> <li><input type="checkbox"/> Cover IP54 / Schutzhaube IP54</li> </ul>		
<p>You can individually configure your suitable product and download technical data and drawings for the combination at <a href="http://www.dunkermotoren.com/en/configuration/">www.dunkermotoren.com/en/configuration/</a>                  Unter <a href="http://www.dunkermotoren.de/konfigurator">www.dunkermotoren.de/konfigurator</a> können Sie Ihr passendes Produkt individuell konfigurieren und technische Daten und Zeichnung für die Kombination herunterladen.</p>		

Dimensions in mm/ Maßzeichnung in mm

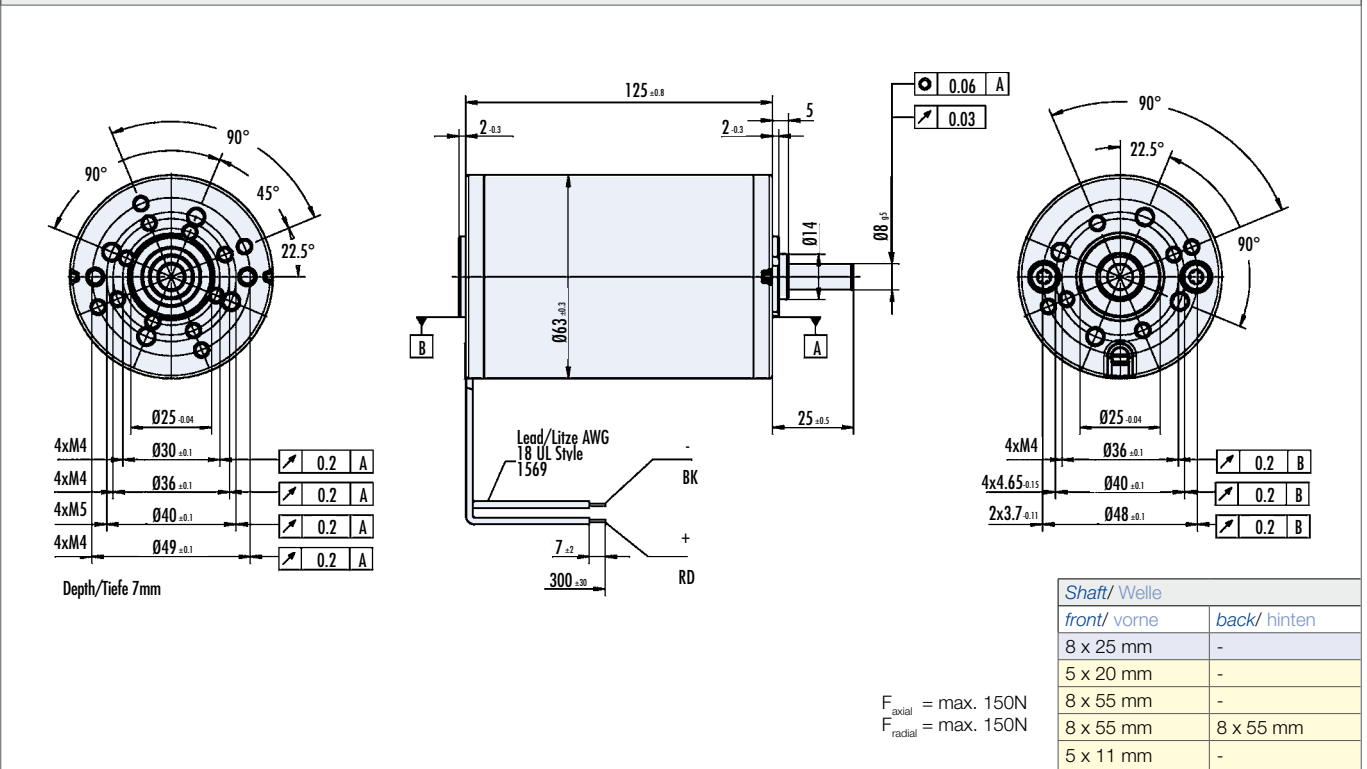

Characteristic diagram/ Belastungskennlinien

In accordance with/ Belastungskennlinien gezeichnet nach EN 60034

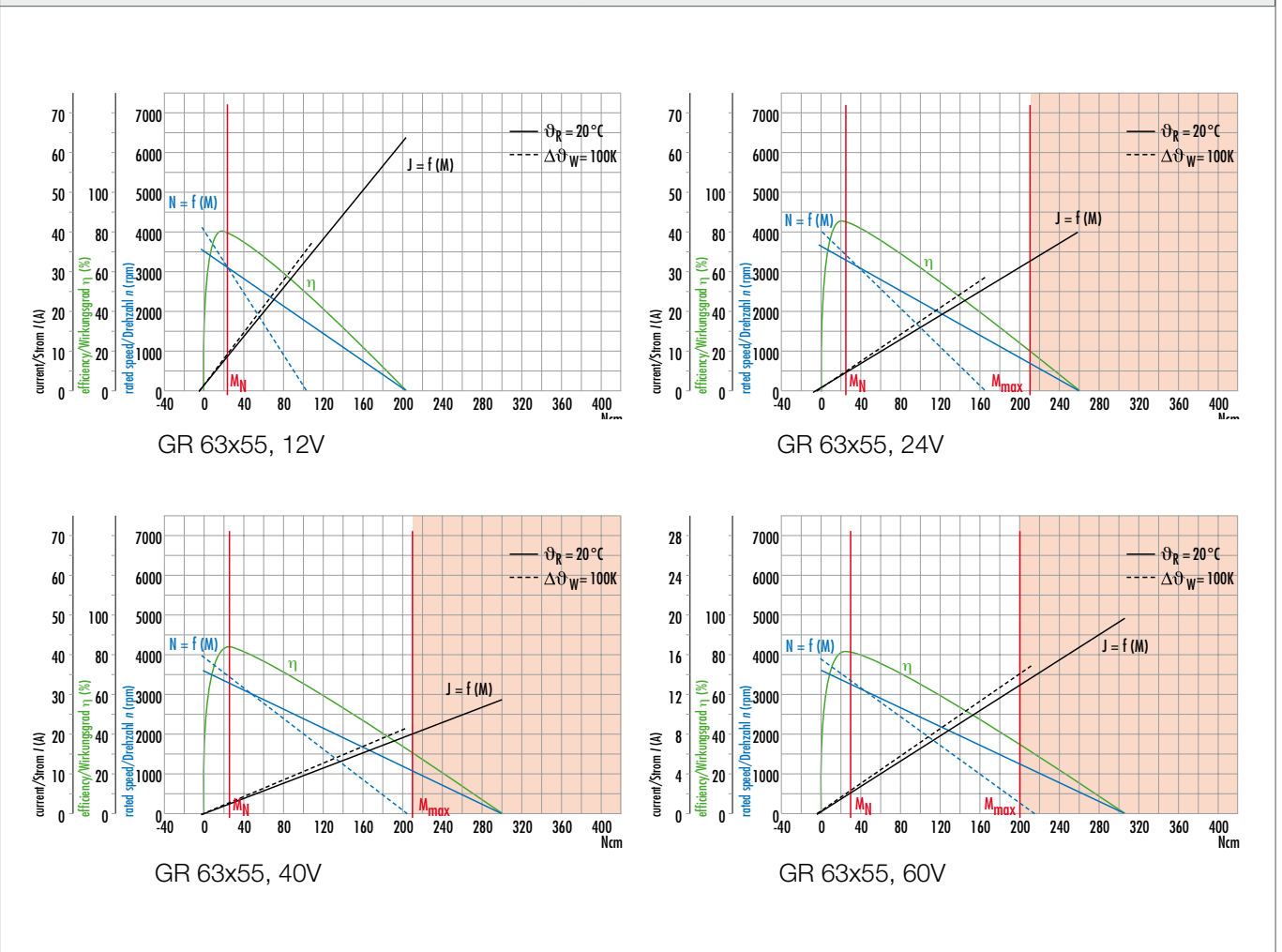

- » Stronger permanent magnet
- » Operation in both directions of rotation
- » Ball bearing at motor output shaft is standard
- » Special screws for low vibrational resonances
- » With custom shaft length and diameter, shaft on both sides, special and high voltage winding, higher protection class up to IP 67, reinforced bearing on request

- » Mit stärkerem Permanentmagneten
- » Drehrichtung Rechts-/ Linkslauf
- » Motorwelle abtriebsseitig kugellagert ist Standard
- » Spezielle Schrauben für geringe Schwingungsresonanzen
- » Abweichende Wellenlängen und -durchmesser, beidseitige Welle, Sonder- und Hochspannungswicklungen, höhere Schutzart bis IP 67, verstärkte Lagerung auf Anfrage

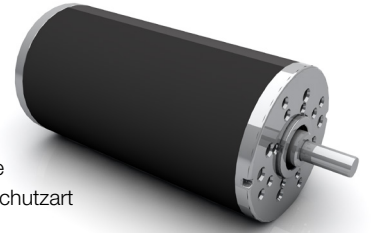

Supply voltage versions	High efficiency	Low noise	Special surface	Protection class	Interference suppression optional	Certification	Certification	Certification (>36 V only)

Data/ Technische Daten		GR 63Sx55		
Nominal voltage/ Nennspannung	VDC	24	40	60
Nominal current/ Nennstrom	A <sup>*)</sup>	5.8	3.7	2.5
Nominal torque/ Nennmoment	Nm <sup>*)</sup>	0.32	0.32	0.34
Nominal speed/ Nenn Drehzahl	rpm <sup>*)</sup>	3500	3750	3550
Stall torque/ Anhaltmoment	Nm <sup>**)</sup>	3.40	3.60	3.70
Maximum torque/ Maximales Moment	Nm <sup>**)</sup>	3.40	3.60	3.70
No load speed/ Leerlaufdrehzahl	rpm <sup>*)</sup>	3700	3900	3725
Nominal output power/ Dauerabgabeleistung	W <sup>*)</sup>	117	126	126
Maximum output power/ Maximale Abgabeleistung	W	330	368	360
Torque constant/ Drehmomentkonstante	Nm A <sup>-1***)</sup>	0.064	0.10	0.161
Terminal Resistance/ Anschlusswiderstand	Ω	0.45	1.13	2.6
Terminal inductance/ Anschlussinduktivität	mH	1.67	4.2	9.4
Starting current/ Anlaufstrom	A <sup>*)</sup>	53.3	36.2	23.1
No load current/ Leerlaufstrom	A <sup>*)</sup>	0.56	0.4	0.2
Magnetizing current/ Entmagnetisierungsstrom	A <sup>*)</sup>	≥ 54	≥ 34	≥ 22
Rotor inertia/ Rotor Trägheitsmoment	gcm <sup>2</sup>	750	750	750
Weight of motor/ Motorgewicht	kg	1.7	1.7	1.7

\*) Δθ<sub>w</sub> = 100 K; \*\*) θ<sub>R</sub> = 20°C \*\*\*) at nominal point/ im Nennpunkt  Preference/ Vorzugsreihe  On request/ auf Anfrage

Modular System/ Modulares Baukastensystem

» Brakes/ Bremsen

- E 46
- E 90
- E 100

» Encoder/ Geber

- ME 52
- RE 20
- RE 30 (TI)
- RE 56 (TI)

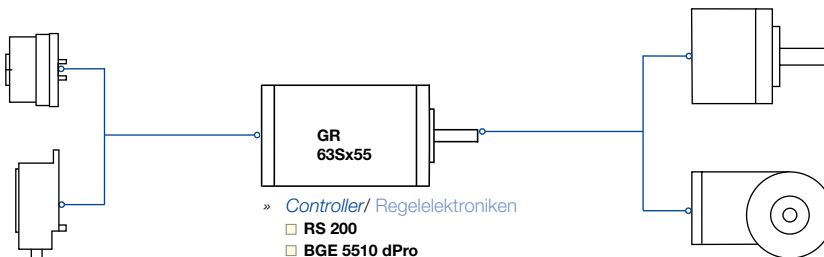

» Controller/ Regelelektroniken

- RS 200
- BGE 5510 dPro
- BGE 6005 A
- BGE 6010 A

» Accessories/ Zubehör

- Cover IP54 / Schutzhaube IP54

» Planetary Gearboxes/  
Planetengetriebe

- PLG 52
- PLG 52 H
- PLG 60
- PLG 63
- PLG 63
- PLG 75

» Angular Gearboxes/  
Winkelgetriebe

- KG 90
- STG 65
- SG 65
- SG 80
- SG 85
- SG 120

You can individually configure your suitable product and download technical data and drawings for the combination at [www.dunkermotoren.com/en/configuration/](http://www.dunkermotoren.com/en/configuration/)

Unter [www.dunkermotoren.de/konfigurator](http://www.dunkermotoren.de/konfigurator) können Sie Ihr passendes Produkt individuell konfigurieren und technische Daten und Zeichnung für die Kombination herunterladen.

Dimensions in mm/ Maßzeichnung in mm

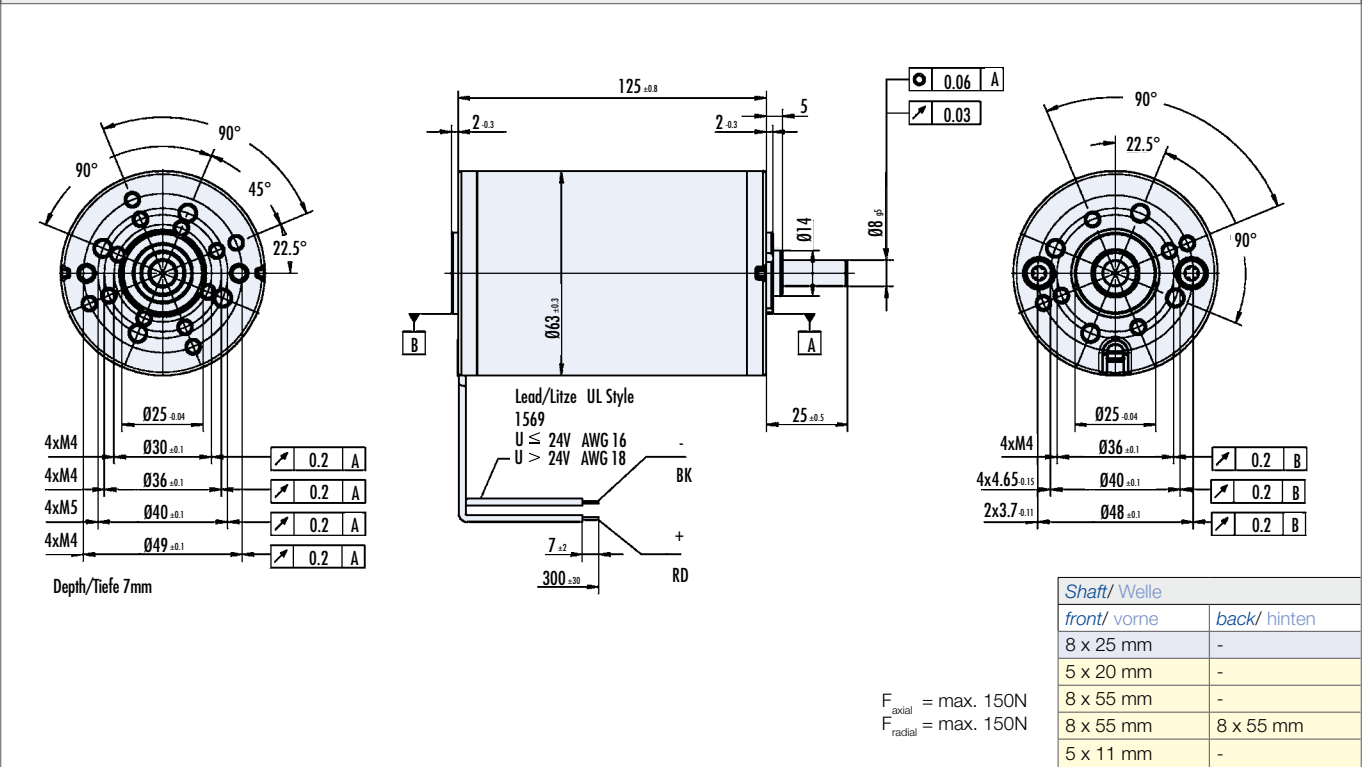

Characteristic diagram/ Belastungskennlinien

In accordance with/ Belastungskennlinien gezeichnet nach EN 60034

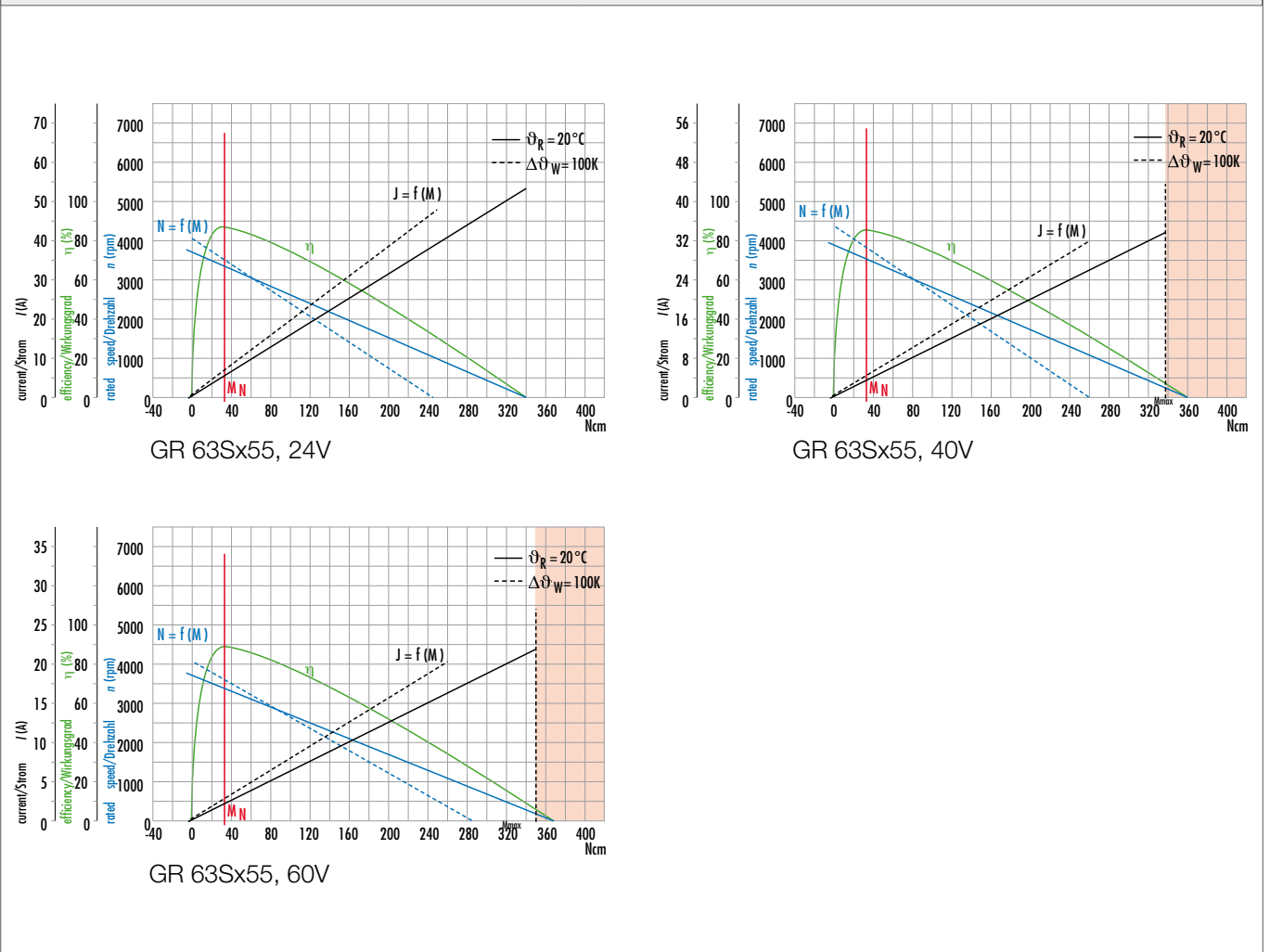

## >> GR 80x40 | cont. 128 W, peak 370 W

- » Operation in both directions of rotation
- » Ball bearing at motor output shaft is standard
- » With custom shaft length and diameter, shaft on both sides, special and high voltage winding, higher protection class up to IP 67 on request

- » Drehrichtung Rechts-/ Linkslauf
- » Motorwelle abtriebsseitig kugellagert ist Standard
- » Abweichende Wellenlängen und -durchmesser, beidseitige Welle, Sonder- und Hochspannungswicklungen, höhere Schutzart bis IP 67 auf Anfrage

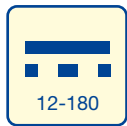
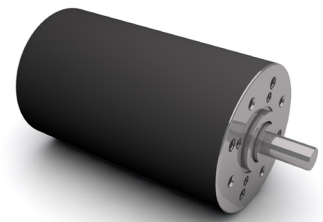

Supply voltage versions



High efficiency



Low noise



Special surface



Protection class

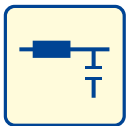

Interference suppression optional



Certification



Certification



Certification (>36 V only)

Data/ Technische Daten		GR 80x40				
Nominal voltage/ Nennspannung	VDC	12	24	40	48	60
Nominal current/ Nennstrom	A <sup>*)</sup>	9.8	6.3	4.3	3.4	2.7
Nominal torque/ Nennmoment	Nm <sup>*)</sup>	0.3	0.38	0.39	0.385	0.385
Nominal speed/ Nennzahl	rpm <sup>*)</sup>	2635	2960	3400	3130	3100
Stall torque/ Anhaltmoment	Nm <sup>**)</sup>	2.4	3.24	4.10	3.56	3.52
Maximum torque/ Maximales Moment	Nm <sup>**)</sup>	-	-	3.12	3.23	3.23
No load speed/ Leerlaufzahl	rpm <sup>*)</sup>	3100	3210	3590	3380	3350
Nominal output power/ Dauerabgabeleistung	W <sup>*)</sup>	82	118	139	127	126
Maximum output power/ Maximale Abgabeleistung	W	195	272	385	315	308
Torque constant/ Drehmomentkonstante	Nm A <sup>-1**)</sup>	0.036	0.068	0.095	0.129	0.163
Terminal Resistance/ Anschlusswiderstand	Ω	0.18	0.5	0.926	1.460	2.27
Terminal inductance/ Anschlussinduktivität	mH	0.9	2.5	5.2	7.3	11.3
Starting current/ Anlaufstrom	A <sup>*)</sup>	67	48	43.2	28	21.7
No load current/ Leerlaufstrom	A <sup>*)</sup>	0.93	0.5	0.330	0.3	0.21
Demagnetisation current/ Entmagnetisierungsstrom	A <sup>*)</sup>	≥ 96	≥ 48	≥ 32	≥ 25	≥ 20
Rotor inertia/ Rotor Trägheitsmoment	gcm <sup>2</sup>	1800	1800	1800	1800	1800
Weight of motor/ Motorgewicht	kg	2.8	2.8	2.8	2.8	2.8

\*)  $\Delta\theta_w = 100\text{ K}$ ; \*\*)  $\theta_n = 20^\circ\text{C}$  \*\*\*) at nominal point/ im Nennpunkt

Preference/ Vorzugsreihe  On request/ auf Anfrage

### Modular System/ Modulares Baukastensystem

#### » Brakes/ Bremsen

- E 90
- E 100
- E 310

#### » Encoder/ Geber

- ME 80
- RE 20
- RE 30 (TI)
- RE 56 (TI)

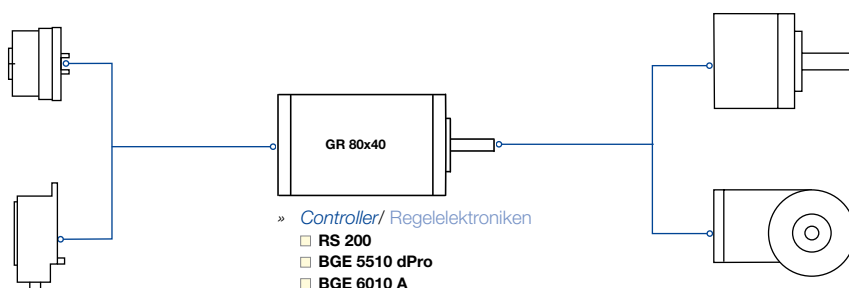

#### » Controller/ Regelelektroniken

- RS 200
- BGE 5510 dPro
- BGE 6010 A

#### » Accessories/ Zubehör

- Cover IP54 / Schutzhaube IP54

#### » Planetary Gearboxes/

##### Planetengetriebe

- PLG 60
- PLG 63
- PLG 75

#### » Angular Gearboxes/

##### Winkelgetriebe

- STG 65
- SG 120

You can individually configure your suitable product and download technical data and drawings for the combination at [www.dunkermotoren.com/en/configuration/](http://www.dunkermotoren.com/en/configuration/)

Unter [www.dunkermotoren.de/konfigurator](http://www.dunkermotoren.de/konfigurator) können Sie Ihr passendes Produkt individuell konfigurieren und technische Daten und Zeichnung für die Kombination herunterladen.

Dimensions in mm/ Maßzeichnung in mm

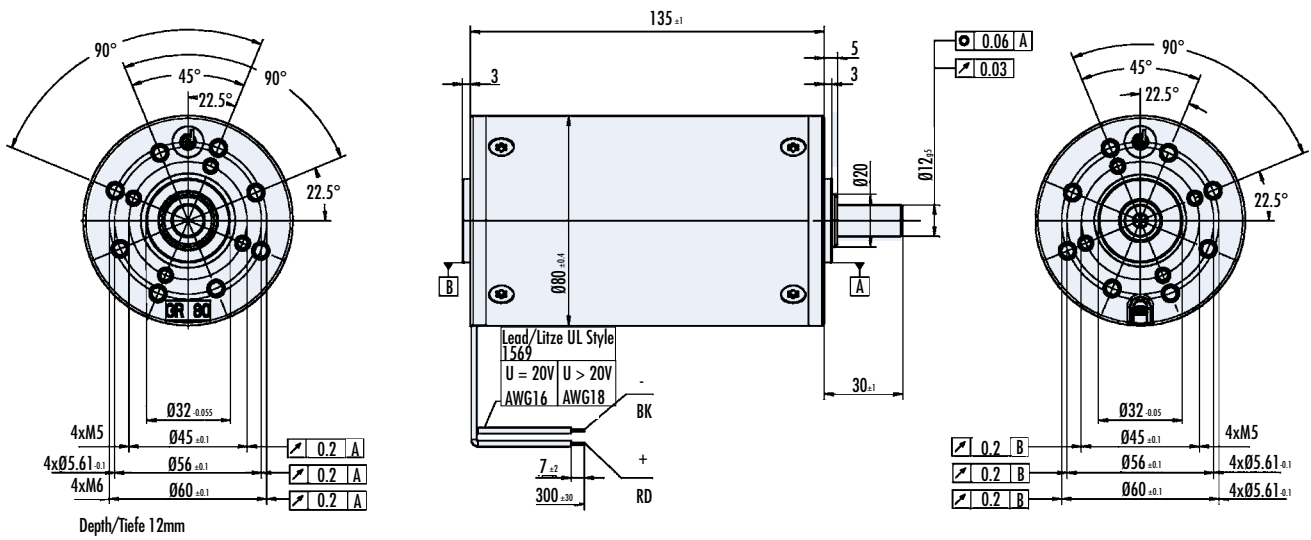

Depth/Tiefe 12mm

F<sub>axial</sub> = max. 180N  
F<sub>radial</sub> = max. 200N

Shaft/ Welle	
front/ vorne	back/ hinten
12 x 30 mm	-
12 x 30 mm	8 x 55 mm

Characteristic diagram/ Belastungskennlinien

In accordance with/ Belastungskennlinien gezeichnet nach EN 60034

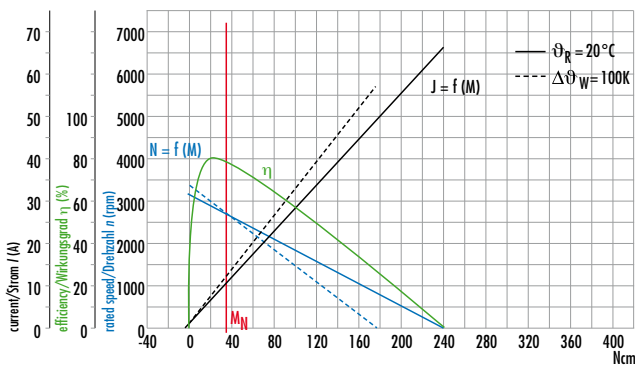

GR 80x40, 12V

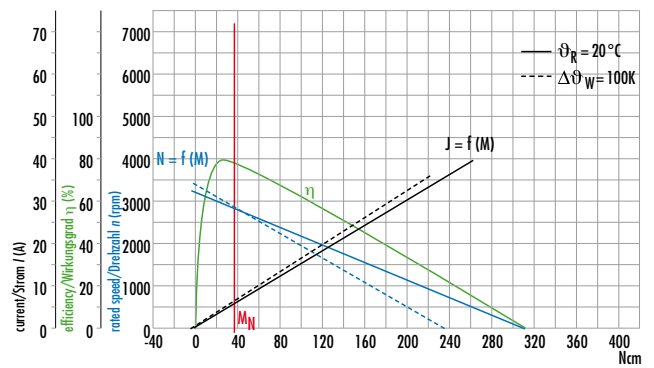

GR 80x40, 24V

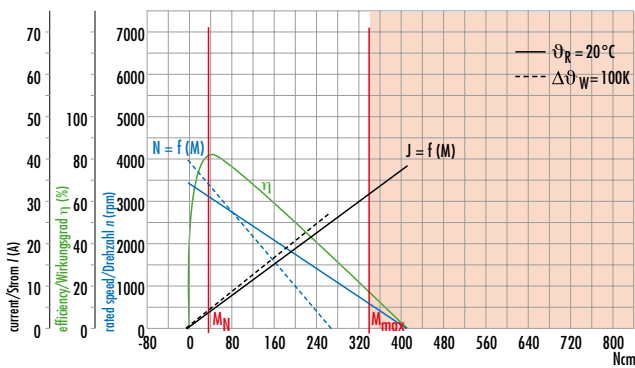

GR 80x40, 40V

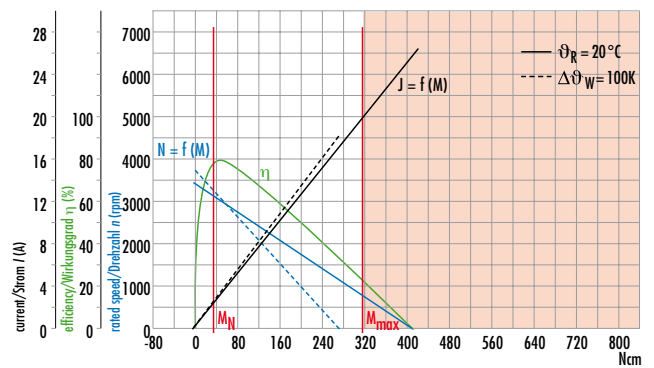

GR 80x40, 60V



## >> GR 80x80 | cont. 221 W, peak 851 W

- » Operation in both directions of rotation
- » Ball bearing at motor output shaft is standard
- » With custom shaft length and diameter, shaft on both sides, special and high voltage winding, higher protection class up to IP 67 on request

- » Drehrichtung Rechts-/ Linkslauf
- » Motorwelle abtriebsseitig kugellagert ist Standard
- » Abweichende Wellenlängen und -durchmesser, beidseitige Welle, Sonder- und Hochspannungswicklungen, höhere Schutzart bis IP 67 auf Anfrage

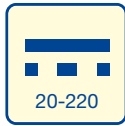
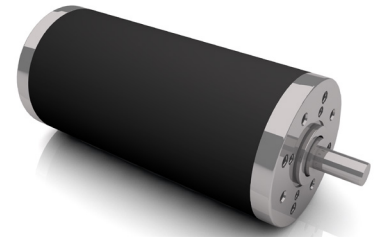

Supply voltage versions



High efficiency



Low noise



Special surface



Protection class

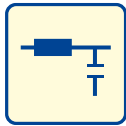

Interference suppression optional



Certification



Certification



Certification (>36 V only)

Data/ Technische Daten		GR 80x80			
Nominal voltage/ Nennspannung	VDC	24	40	48	60
Nominal current/ Nennstrom	A <sup>*)</sup>	10	6.2	5.6	4.3
Nominal torque/ Nennmoment	Nm <sup>*)</sup>	0.59	0.67	0.67	0.67
Nominal speed/ Nennrehzahl	rpm <sup>*)</sup>	3150	2970	3200	3090
Stall torque/ Anhaltmoment	Nm <sup>**)</sup>	7.45	8.85	9.47	9.22
Maximum torque/ Maximales Moment	Nm <sup>**)</sup>	6.06	6.01	6	6
No load speed/ Leerlaufrehzahl	rpm <sup>*)</sup>	3285	3050	3300	3200
Nominal output power/ Dauerabgabeleistung	W <sup>*)</sup>	195	208	224.5	217
Maximum output power/ Maximale Abgabeleistung	W	641	707	817	764
Torque constant/ Drehmomentkonstante	Nm A <sup>-1**)</sup>	0.067	0.118	0.132	0.171
Terminal Resistance/ Anschlusswiderstand	Ω	0.214	0.533	0.67	1.01
Terminal inductance/ Anschlussinduktivität	mH	1.5	3.73	4.7	6.9
Starting current/ Anlaufstrom	A <sup>*)</sup>	112	75	72	54
No load current/ Leerlaufstrom	A <sup>*)</sup>	0.7	0.37	0.35	0.3
Demagnetisation current/ Entmagnetisierungsstrom	A <sup>*)</sup>	≥ 91	≥ 51	≥ 46	≥ 35
Rotor inertia/ Rotor Trägheitsmoment	gcm <sup>2</sup>	3200	3200	3200	3200
Weight of motor/ Motorgewicht	kg	4.0	4.0	4	4.0

\*)  $\Delta\theta_w = 100\text{ K}$ ; \*\*)  $\vartheta_R = 20^\circ\text{C}$  \*\*\*) at nominal point/ im Nennpunkt  Preference/ Vorzugsreihe  On request/ auf Anfrage

### Modular System/ Modulares Baukastensystem

#### » Brakes/ Bremsen

- E 90
- E 100
- E 310

#### » Encoder/ Geber

- ME 80
- RE 20
- RE 30 (TI)
- RE 56 (TI)

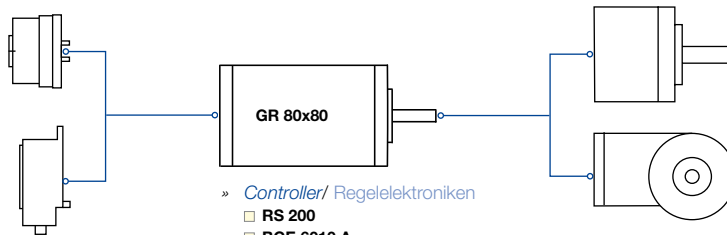

#### » Controller/ Regelelektroniken

- RS 200
- BGE 6010 A
- BGE 5510 dPro

#### » Accessories/ Zubehör

- Cover IP54 / Schutzhaube IP54

#### » Planetary Gearboxes/ Planetengetriebe

- PLG 60
- PLG 63
- PLG 75

#### » Angular Gearboxes/ Winkelgetriebe

- SG 120
- STG 65

You can individually configure your suitable product and download technical data and drawings for the combination at [www.dunkermotoren.com/en/configuration/](http://www.dunkermotoren.com/en/configuration/)

Unter [www.dunkermotoren.de/konfigurator](http://www.dunkermotoren.de/konfigurator) können Sie Ihr passendes Produkt individuell konfigurieren und technische Daten und Zeichnung für die Kombination herunterladen.

Dimensions in mm/ Maßzeichnung in mm

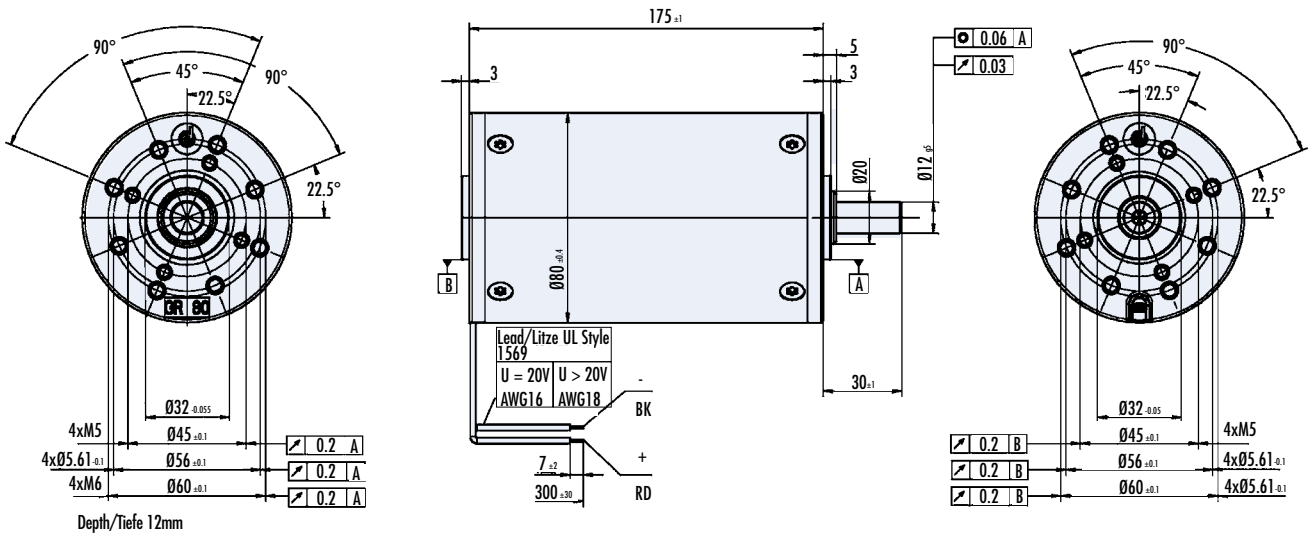

F<sub>axial</sub> = max. 180N  
F<sub>radial</sub> = max. 200N

Shaft/ Welle	
front/ vorne	back/ hinten
12 x 30 mm	-
12 x 30 mm	8 x 55 mm

Characteristic diagram/ Belastungskennlinien

In accordance with/ Belastungskennlinien gezeichnet nach EN 60034

