



## Sensor technology PSEN®

**pitz**  
the spirit of safety

- ▶ Devices for position monitoring ▶ Safety switches
- ▶ Safety gate systems ▶ Light beam devices
- ▶ Safe camera systems ▶ Control and signal devices





## COMPONENTS

Sensor, control and drive technology

## SYSTEMS

Automation systems

**The 4-fold safety of automation**

### Technical

Put your trust in innovative products and tailor-made solutions

### Personal

Rely on professional advice and individual care

### Ecological

Build on energy-efficient products and friendly applications

Pilz is your solution supplier for all automation tasks. Including standard control functions. Pilz developments protect man, machine and the environment.

Pilz has a tradition as a family-run company stretching back over 60 years. Real proximity to customers is visible in all areas, instilling confidence through individual consultation, total flexibility and reliable service. Worldwide, round the clock, in 31 subsidiaries and branches, as well as 21 sales partners on every continent.

More than 1 900 staff, each one of them an ambassador for safety, make sure that your company's most valuable asset – your staff – can work safely and free from injury.



Further information:  
[www.pilz.com](http://www.pilz.com) +  
Webcode 0837

## SERVICES

Consulting, engineering  
and training

### Economical

Count on efficient production and  
the security of investment provided  
by our system solutions

**pilz**  
the spirit of safety

Automation  
solutions from Pilz –  
at home in every  
industry.





The safe solution:  
Sensor and control technology.

# ► Safe sensor technology PSEN®

Pilz sensors PSEN and control and signal devices PIT guarantee that machinery and complex plants can be used efficiently while still complying with standards intended to protect man and machine. The versatile portfolio provides individual solutions for every requirement: from monitoring of positions, covers, safety gates and areas to three-dimensional zone monitoring.

Based on different technologies such as RFID or camera-based, PSEN sensor technology offers maximum safety along with barrier-free access to the work process where possible. When combined with safe control technology from Pilz, you get a cost-effective, all-in-one solution.

## Contents

---

<b>Automation: complete and simple!</b>	6	<b>Product group: light beam devices</b>	52
		► Light beam devices PSENOpt	54
<b>Product area: sensor technology</b>	8	► Light beam devices PSENOpt Advanced	56
<b>Product group: devices for position monitoring</b>		<b>Product group: safe camera systems</b>	
► Safe proximity switch PSENini	12	► Camera-based protection system PSENVip	68
► Safe rope pull switch PSENrope	14	► Safe camera system SafetyEYE	72
► Rotary encoder PSENEnco	16		
<b>Product group: safety switches</b>	18	<b>Product group: control and signal devices</b>	
► Mechanical safety switch PSENmech	20	► Emergency stop pushbutton PITestop	76
► Magnetic safety switch PSENmAG	24	► Operating mode selector switch PITmode	84
► Coded safety switch PSENcode	30	► Manually operated control device PITjog	88
► Safety bolt PSENbolt	38	► Enabling switch PITenable	90
► Safe hinge switch PSENhinge	40	<b>Product range:</b>	
<b>Product group: safety gate systems</b>	42	<b>decentralized modules PDP67 and PDP20</b>	92
► Safety gate system PSENSlock	44	<b>Cable accessories: sensor technology</b>	94
► Safety gate system PSENSgate	48	<b>Accessories: sensor technology</b>	110
		<b>Index</b>	119



Scan the QR code to see all 3D animations from our sensor technology product area on YouTube.



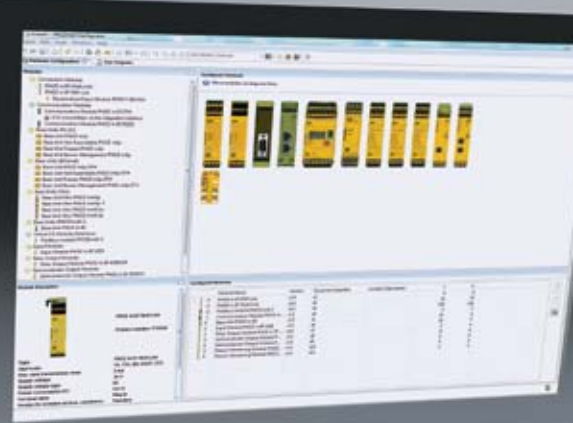

Visualisation; Diagnostics

Easy to Configure



**Automation solutions for your plant and machinery – complete and simple.**

Pilz offers you solutions for complete automation. From sensor technology to control and drive technology – with safety and automation included. On all components and systems, simple commissioning, simple handling

and simple diagnostics play an important role!

Profit from flexible automation solutions for small machines or even large, networked plants. Regardless of whether you want to standardize your safety, implement safety and automation in the periphery or are looking for the solution for complete automation.

Pilz solutions are embedded into the relevant system environment – whether a new structure or a retrofit – and open for a variety of interfaces and functionalities.

**The perfect combination:**

**Control technology** enables numerous application options, including monitoring of electrical



Programming IEC 61131-3

Rapid Installation

## Automation: complete and simple!

- ▶ Full diagnostic options for reduced machine downtimes
- ▶ Open communication for high flexibility
- ▶ Innovative software solutions for easy configuration, programming and visualization
- ▶ High scalability for individual solutions
- ▶ One system for safety and automation



and functional safety, through to complete machine control.

In combination with the various control systems, safe **sensors** and **decentralized modules** guarantee the efficient use of plant and machinery in compliance with standards. Ready-to-install systems and universally compatible solutions offer high potential savings.

In the area of **drive technology**, the offer includes drive-integrated safety functions, safe logic functions and the connection of visualization, sensor and actuator technology.

Your plant or machinery are completed with **operator and graphics devices** from Pilz.

Design, programming, configuration, commissioning, diagnostics and visualization can be achieved quickly and simply using Pilz **automation software**.

Pilz offers scalable solutions to suit each requirement – from sensor technology to control and drive technology.



## ► For every requirement – Safe sensors PSEN®

Pilz offers a wide range of safe sensors that conform to international standards and have been tested and approved by certification bodies. As the Pilz sensors were developed, great value was placed on performance, robustness, quality and easy of operation.

### Free choice for your application

Safe sensors are suitable for use on covers, flaps, rolling doors, safety gates, cams, electro-sensitive protective equipment and for position detection. In the overview you'll find the right sensors to suit your safety requirement. For example, if your safety gate needs a sensor with no guard locking function, with non-contact operation and the highest level of manipulation protection, PSENcode is the right choice.

### The right technology

The high variability of safe sensors PSEN is apparent in the different technologies: whether mechanical, magnetic, RFID, optical or camera-based – Pilz has used its know-how and experience to make optimum use of all technologies.

### Protection for your investment

Pilz sensors fit perfectly into your plant environment and also enable Pilz components to be retrofitted to your plant or machine. PSEN are also compatible with products and interfaces from other manufacturers.

Keep up-to-date on sensor technology PSEN:

 Webcode 5172

Online information at [www.pilz.com](http://www.pilz.com)

### Selection guide – Sensor technology PSEN

#### Covers/flaps/rolling doors



Safety gates



Position detection/cams



Areas/zones

Yes

Guard locking device

No















Highest manipulation protection



Position monitoring



Dead voltage closed		<ul style="list-style-type: none"> <li>▶ Safety gate system PSENSgate</li> <li>▶ Mechanical safety switch PSENmech (me1S)</li> <li>▶ Safety bolt PSENbolt with PSEN me1S (spring force)</li> </ul>	<p>From page 48</p> <p>From page 20</p> <p>From page 38</p>	 
		<ul style="list-style-type: none"> <li>▶ Safety gate system PSENSlock</li> <li>▶ Mechanical safety switch PSENmech (me1M)</li> <li>▶ Safety bolt PSENbolt with PSEN me1M (magnetic force)</li> </ul>	<p>From page 44</p> <p>From page 20</p> <p>From page 38</p>	
Mechanical		<ul style="list-style-type: none"> <li>▶ Safety bolt PSENbolt with PSEN ma1.4</li> <li>▶ Safe hinge switch PSENhinge</li> </ul>	<p>From page 38</p> <p>From page 40</p>	
	Normal manipulation protection	<ul style="list-style-type: none"> <li>▶ Magnetic safety switch PSENmag</li> <li>▶ Safety bolt PSENbolt with PSEN ma1.4</li> </ul>	<p>From page 24</p> <p>From page 38</p>	 
Non-contact	Highest manipulation protection	<ul style="list-style-type: none"> <li>▶ Coded safety switch PSENcode</li> <li>▶ Safety bolt PSENbolt with PSENcode</li> </ul>	<p>From page 30</p> <p>From page 38</p>	 
	Without counterpart	<ul style="list-style-type: none"> <li>▶ Safe proximity switch PSENIini</li> </ul>	<p>From page 12</p>	
Non-contact	With counterpart	<ul style="list-style-type: none"> <li>▶ Magnetic safety switch PSENmag</li> <li>▶ Coded safety switch PSENcode</li> </ul>	<p>From page 24</p> <p>From page 30</p>	
		<ul style="list-style-type: none"> <li>▶ Light beam devices PSENOpt</li> <li>▶ Light beam devices PSENOpt Advanced</li> <li>▶ Camera-based protection system PSENVip</li> </ul>	<p>From page 54</p> <p>From page 56</p> <p>From page 68</p>	 
Zone monitoring (3D)		<ul style="list-style-type: none"> <li>▶ Safe camera system SafetyEYE</li> </ul>	<p>From page 72</p>	

# ► Versatile product portfolio – Safe sensor technol

While high plant efficiency is a requirement in an industrial environment, it's important not to neglect the protection of man, machine and the environment: from commissioning to high availability during operation. Pilz sensors PSEN provide a safe, flexible solution.

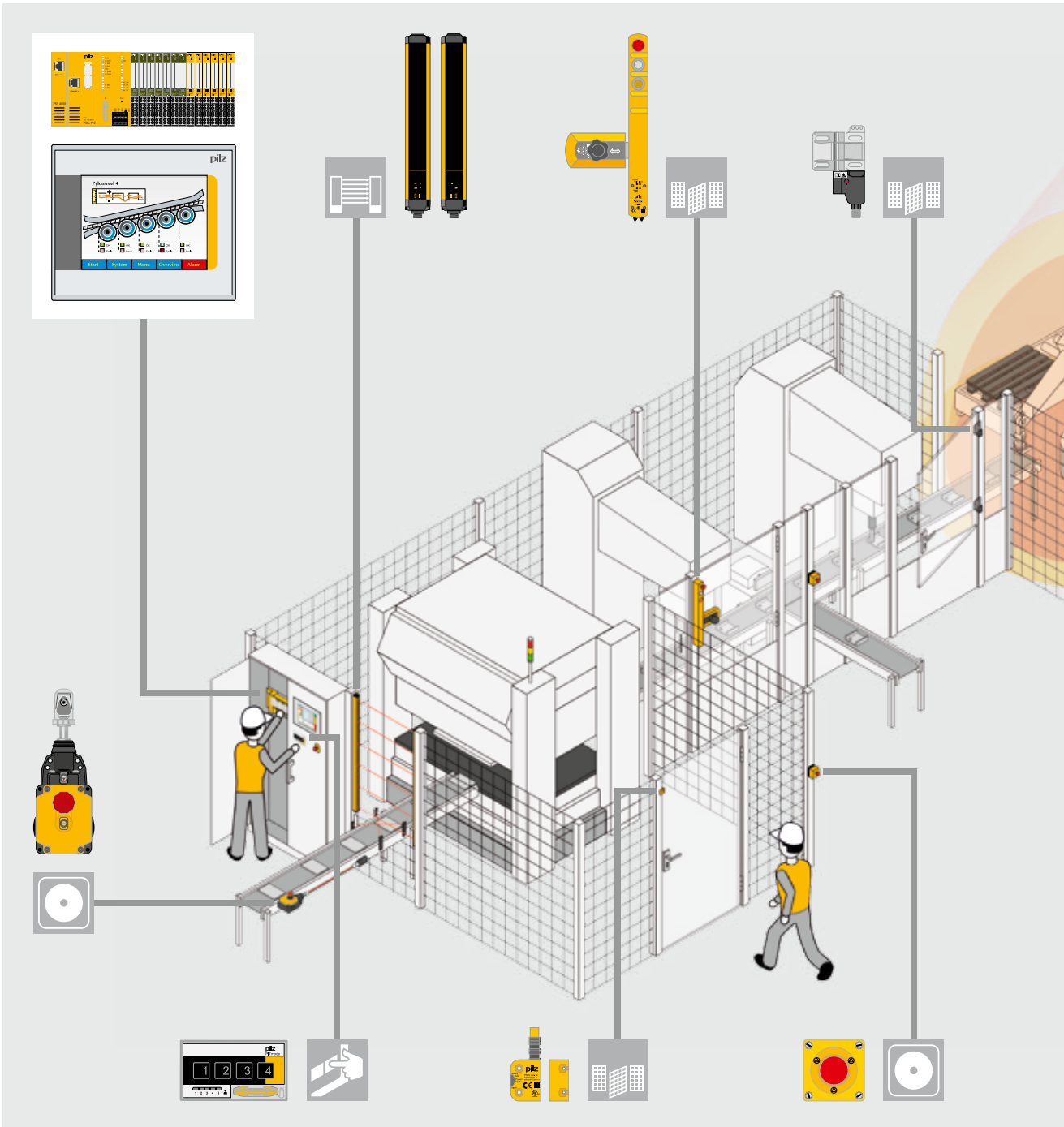

The complete, one-stop solution that's safe and economical: sensor and control technology from Pilz.

# ogy PSEN®

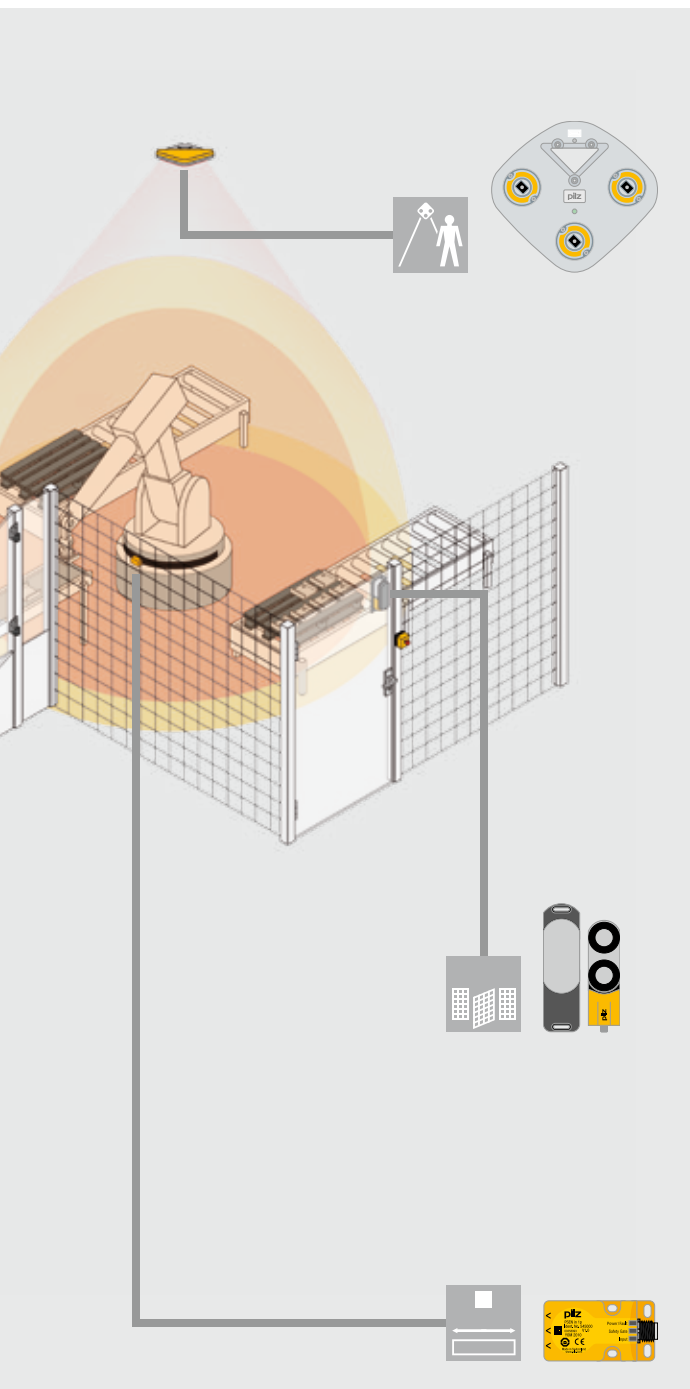

### High compatibility

Sensors from the various product ranges are compatible and can be connected in series. That reduces the inputs during installation, as well as saving time and costs during configuration and commissioning.

### For any budget

As a ready-to-install system, potential engineering savings is not the only benefit offered from safe sensors PSEN. Many sensors are equipped with different operating principles, enabling the solution to be geared towards your requirement.

### Quality with safety

The product design has been developed individually for each PSEN product range, both technically and functionally; it's been attractively engineered, with a safe, sophisticated concept. Pilz is certified to EN ISO 9001 and our safety products have been developed for use in accordance with EN ISO 13849-1 and EN/IEC 62061.

Based on the different features and functionalities, our sensors can be divided into various product ranges. The graphic on this double page will help you choose. If you have specific requirements, we have the right products and solutions:

- ▶ Devices for position monitoring – from page 12
- ▶ Safety switches – from page 18
- ▶ Safety gate systems – from page 42
- ▶ Light beam devices – from page 52
- ▶ Safe camera systems – from page 68
- ▶ Control and signal devices – from page 76

Keep up-to-date on sensor technology PSEN:

 Webcode 5172

Control and signal devices

 Webcode 5293

Online information at [www.pilz.com](http://www.pilz.com)

## ▶ Safe proximity switch PSENiNi

Safe monitoring without actuators – that’s what the safe proximity switch PSENiNi provides. It detects the approach of metallic objects without the use of contacts and supplies the necessary safe signals about positions and end limits. PSENiNi can also generate the pulse for counting tasks or for detecting rotational movements.



IP67



PSENi in1p

### Applications for PSENiNi

- ▶ Cams
- ▶ Rolling doors
- ▶ Pulse generator for counting tasks or rotational movements

### High productivity and long service life

Compared with mechanical switches, PSENiNi provides the ideal prerequisites for high productivity and a long service life: non-contact, non-wearing operation, plus high switching frequencies.

The safe proximity switch is also insensitive to vibration and dust.

### High savings potential in series

Take advantage of the high savings potential of PSENiNi, even under the highest safety requirements, because you can also connect PSENiNi in series with safety switches PSENiCode and safety gate systems PSENiSlock and PSENiSgate.



### Type code for PSENiNi

#### PSENi in1p

Product area Pilz SENSors	Series	Connection type
Product range in – PSENiNi	1 Series 1	p Connector, M12, 8-pin (series connection integrated in sensor)
Operation Non-contact, inductive		n Male connector, M12, 5-pin



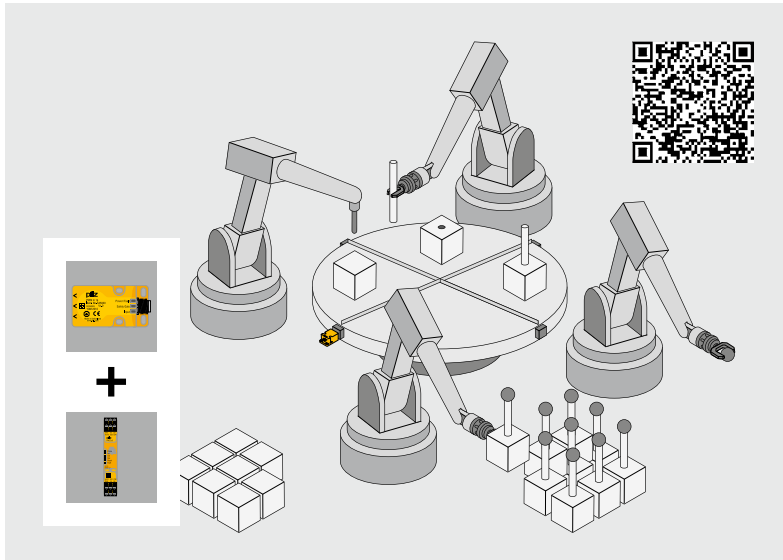

**Your benefits at a glance**

- ▶ Investment protection: can be combined directly with a wide range of evaluation devices
- ▶ User-friendly: rapid diagnostics via LED
- ▶ Economical and flexible: series connection means less wiring and fewer inputs
- ▶ Greater productivity thanks to short reaction time
- ▶ Highly versatile:
  - Suitable for counterpieces made of a variety of metals
  - Insensitive to shock
- ▶ Long product service life due to wear-free function



Components for your safe solution	Order number
Sensor: PSEN in1p	545 000
Connection: PSEN cable, M12, 8-pin, 5 m	540 320
Evaluation device: PNOZ s3	751 103

The optimum solution: monitoring the position of the turntable with proximity switch PSENiNi and safety relay PNOZsigma.

**Selection guide – Safe proximity switch PSENiNi**



PSEN in1p

Type	Connection type	Series connection in combination with PSENiNi, PSEnlock, PSEncode <sup>1)</sup>	Order number
PSEN in1p	Male connector, M12, 8-pin	<ul style="list-style-type: none"> <li>▶ Y junction (cable separator)</li> <li>▶ PDP67 F 4 code</li> </ul>	545 000
PSEN in1n	Male connector, M12, 5-pin	<ul style="list-style-type: none"> <li>▶ PDP67 F 8DI ION</li> </ul>	545 003

<sup>1)</sup> Up to PL e of EN ISO 13849-1 and SIL CL 3 of EN/IEC 62061

**Common features**

- ▶ Typical operating distance (steel): 15 mm
- ▶ Diagnostic interface: 3 LEDs (status of actuator, status of inputs, supply voltage/error)
- ▶ Directions of actuation: 1
- ▶ Approach directions: 1
- ▶ Outputs: 2 safety outputs and 1 signal output
- ▶ Inputs (PSEN in1p): 2 safety inputs

Cable and other accessories:

From page 94

Further information and technical documentation on the safe proximity switch PSENiNi:

Webcode 6256

Online information at [www.pilz.com](http://www.pilz.com)

## ▶ Safe rope pull switch PSENRope

Whether on the assembly line or machine – where safety in the production area is concerned, the safe rope pull switch PSENRope is a proven, reliable solution. PSENRope switches off functional processes through manual operation. It offers maximum safety: that's because the emergency stop function can be triggered at any point along the rope.



PSEN rs1.0

PSEN rs2.0

### Optimum safety solution is as simple as that

PSENRope is flexible to use, easy to install and simple to operate. Whether it's a first-time installation or upgrade: the safe rope pull switch PSENRope simplifies installation with its sophisticated technical details.

### Durable – even under extreme conditions

As the operating range of rope pull switches is limited only by the length of the rope, even large plants can be safeguarded using PSENRope. Due to its rugged finish, PSENRope is reliable even under extreme environmental conditions.



### Type code for PSENRope

#### PSEN rs1.0-300

Product area Pilz SENSors	Housing material	Contacts	Max. spring force to tension the rope
Product range rs – PSENRope	1 Al die cast 2 Plastic	0 2 NC, 2 NO	175 175 N 300 300 N
Operation Mechanical			

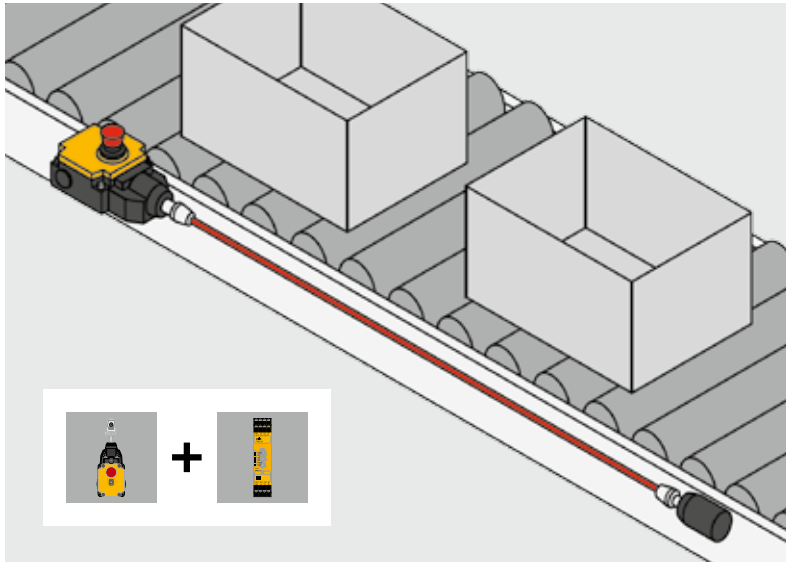

Greater safety on the production line: the rapid emergency stop with rope pull switch PSENrope in combination with the safety relay PNOZsigma.

**Your benefits at a glance**

- ▶ High level of safety:
  - Safe from manipulation
  - Wiring space physically separate from mechanics
  - Dual function mushroom-type pushbutton and pull-to-release in one
- ▶ Whether it's a first-time installation or upgrade: PSENrope simplifies installation
- ▶ Suitable for indoor and outdoor use thanks to rugged, hard-wearing metal or plastic housing



**Selection guide – Safe rope pull switch PSENrope**



PSEN rs1.0-175

Type	Housing material	Maximum rigging length	Order number
PSEN rs1.0-175	Al die cast	37.5 m	570301
PSEN rs1.0-300	Al die cast	75.0 m	570300
PSEN rs2.0-175	Plastic	37.5 m	570303
PSEN rs2.0-300	Plastic	75.0 m	570302

**Common features**

- ▶ Suitable for applications up to:
  - PL e of EN ISO 13849-1
  - SIL CL 3 of EN/IEC 62061
- ▶ Integrated E-STOP pushbutton
- ▶ Contacts: 2 NC, 2 NO
- ▶ Protection type: IP67
- ▶ Ambient temperature:
  - PSEN rs1.0: -30 ... +80 °C
  - PSEN rs2.0: -25 ... +70 °C
- ▶ Dimensions (H x W x D) in mm:
  - PSEN rs1.0: 237 x 90.0 x 88
  - PSEN rs2.0: 294 x 42.5 x 88

Cable and other accessories:

 From page 94

Technical documentation on the safe rope pull switch PSENrope:

 Webcode 6568

Online information at [www.pilz.com](http://www.pilz.com)

**Accessories**

Type	Features	Order number
PSEN rs spring 175	Counterspring, 175 N	570310
PSEN rs spring 300	Counterspring, 300 N	570311
PSEN rs pulley 75	Return pulley, diameter: 75 mm	570312
PSEN rs pulley flex	Block rope pulley, rotatable	570313
PSEN rs rope d3/d4 50 m	▶ Rope diameter: 3 mm	570314
PSEN rs rope d3/d4 100 m	▶ Insulation diameter: 4 mm ▶ PVC-coated, red	570315

## ▶ Rotary encoder PSEnenco

The rotary encoders PSEnenco are used to determine position and speed. The rotary encoder is an absolute encoder that is used in the automation system PSS 4000. It supplies diverse, absolute position values, which are verified in the software block. The rotary encoder has a magnetic and an optical measuring system and thus combines two units in one.



PSEN enc m1 eCAM



PSEN enc m2 eCAM

### Standard rotary encoder, but safe

The rotary encoder PSEnenco is a standard encoder – but through the combination of the control system PSSuniversal PLC, the rotary encoder and software blocks, the system reaches SIL CL 3 and PL e.

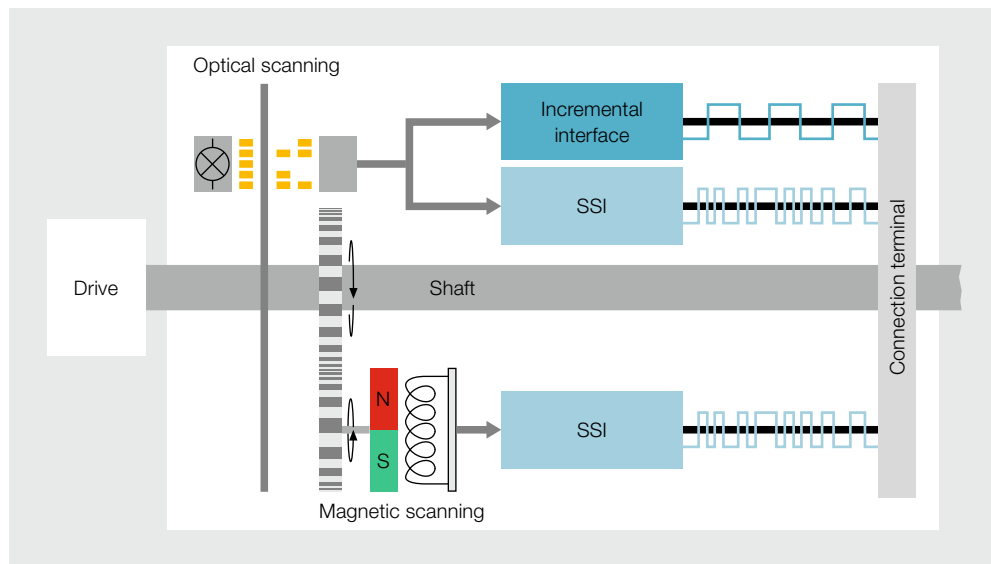

Redundant, dual-channel rotary encoder

### Type code for PSEnenco

#### PSEN enc m1 eCAM

<b>Product area</b> Pilz SENSors	<b>Rotary encoder feature</b>	<b>Series</b>	<b>Design</b>
<b>Product range</b> enc – PSEnenco	<b>m</b> Multi-turn <b>s</b> Single-turn	<b>1</b> Hollow shaft <b>2</b> Solid shaft	<b>eCAM</b> Electronic rotary cam arrangement
<b>Operation</b> Magnetic and optical			



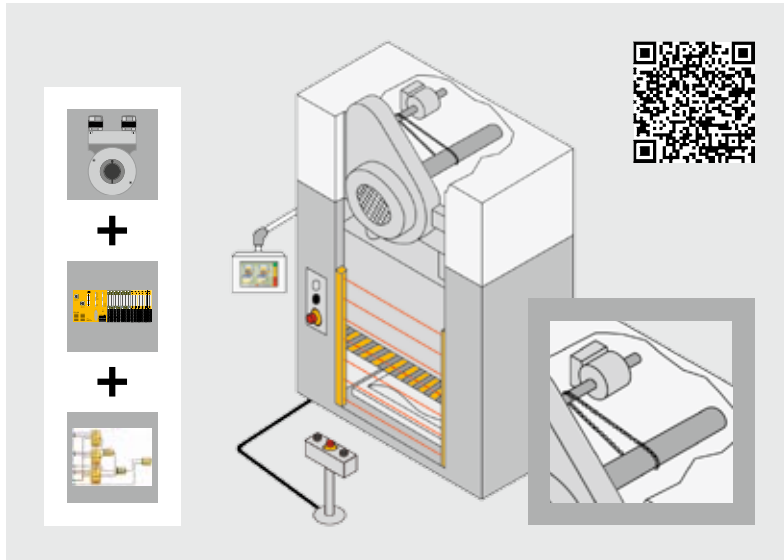

**Your benefits at a glance**

- ▶ Safe evaluation of speed and position
- ▶ The safe monitoring function is transferred to the user software
- ▶ High flexibility when monitoring limit values due to dynamic limit value monitoring in the user program
- ▶ Mechanical rotary cam arrangement is replaced by the safe electronic rotary cam arrangement PSS 4000 incl. PSEnenco

Components for your safe solution	Order number
Sensor: PSEN enc m1 eCAM	544 021
Connection: Signal cable, min. 0.25 mm <sup>2</sup> , shielded, stranded pair	-
Evaluation device: PSSu PLC1 FS SN SD	312 070

The optimum solution: rotary encoder, control system and software = safe electronic rotary cam arrangement.

**Application of PSEnenco**

The rotary encoder PSEnenco is used in the mechanical press sector, for instance. The Pilz “safe electronic rotary cam arrangement” solution completely replaces conventional mechanical rotary cam arrangements. Further application areas can be found anywhere that safe position detection is required.

**Selection guide – Rotary encoder PSEnenco**



PSEN enc m1 eCAM

Type	Function	Rotary encoder feature	Order number
<b>PSEN enc m1 eCAM</b>	Absolute encoder	Multi-turn, hollow shaft	544 021
<b>PSEN enc m2 eCAM</b>	Absolute encoder	Multi-turn, solid shaft	544 022
<b>PSEN enc s1 eCAM</b>	Absolute encoder	Single-turn, hollow shaft	544 011
<b>PSEN enc s2 eCAM</b>	Absolute encoder	Single-turn, solid shaft	544 012

**Common features**

- ▶ Two encoders in one housing
- ▶ Diverse, 2-channel (1 x optical, 1 x magnetic)
- ▶ 2 SSI interfaces
- ▶ SIL CL 3 and PL e in the automation system PSS 4000

More information on the rotary encoder PSEnenco:

Webcode 7331

Online information at [www.pilz.com](http://www.pilz.com)

## ► Safety switches

Safety switches from Pilz are used for cost-optimized safety gate and position monitoring and meet the requirements of EN ISO 14119 (successor standard to EN 1088) at particularly low cost. That's why they are used for applications in mechanical engineering as well as in the packaging or pharmaceutical industry and many other sectors.

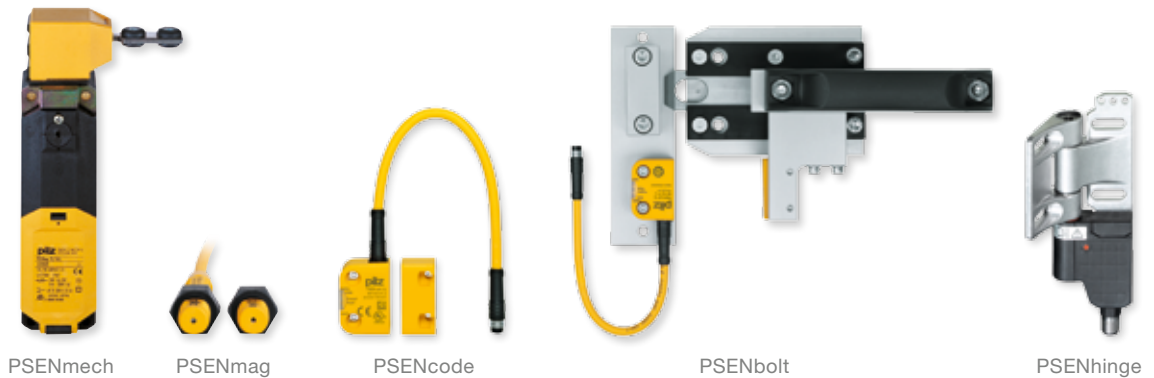
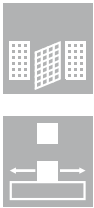

Safety switches are available with various designs and operating principles and can even be used under difficult environmental conditions. Additional costs can be saved when connected in series.

### Choose the optimum switch for your application:

- Mechanical – PSENmech offers personal and process protection with safe guard locking
- Non-contact, magnetic – with concealed installation PSENmag is the most economical solution – for the highest safety requirements
- Non-contact, unique, fully coded – PSENcode allows maximum freedom in installation thanks to the highest manipulation protection for guards, as required in EN ISO 14119
- Non-contact, coded – PSENcode x.19n is suitable for safe monitoring and distinguishing up to three positions

**Safety bolt – the robust, cost-effective solution for a rugged industrial environment**

The safety bolt PSEnbolt is particularly suitable for safety gates that are difficult to adjust or in areas where safety gates are often opened and closed. What you get is a complete solution comprising safety switch, handle and bolt.

**Safe hinge switch – packaged hinge and safety switch**

The combination of hinge and safety switch is the optimum solution for hinged safeguards. Designed as one functional and installation unit, the safe hinge switch PSENhinge offers high flexibility in installation, connection and adjustment.

**Selection guide – Safety switches and safe hinge switches**

Type	Safety switch PSENmech	Safety switch PSEnmag	Safety switch PSENcode	Safety switch PSENcode	Hinge switch PSENhinge
Operation/Coding	Mechanical	Non-contact, magnetic	Non-contact, coded	Fully coded, unique fully coded	Mechanical
<b>Application</b>					
Covers	◆	◆	◆	◆	
Flaps	◆	◆	◆	◆	◆
Hinged safety gates	◆	◆	◆	◆	◆
Sliding safety gates	◆	◆	◆	◆	
Rolling doors		◆	◆	◆	
Position detection		◆	◆	◆	
Guard locking device	With	Without	Without	Without	Without
IP protection type	IP67	IP67/IP6K9K	IP67/IP6K9K	IP67/IP6K9K	IP67
<b>Performance Level<sup>1)</sup></b>					
PL e	2 x	1 x	1 x	1 x	2 x
PL d	1 x + FE <sup>2)</sup>	1 x	1 x	1 x	1 x + FE <sup>2)</sup>
PL c	1 x	1 x	1 x	1 x	1 x
<b>Classification in accordance with EN ISO 14119</b>					
Type	2	4	4	4	1
Coding level	Low	Low	Low	High	-

<sup>1)</sup> Achievable Performance Level depends on application  
<sup>2)</sup> FE = Fault exclusion

Keep up-to-date on Safety switches:

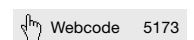

Online information at [www.pilz.com](http://www.pilz.com)

## ▶ Mechanical safety switch PSENmech

The mechanical safety switch PSENmech is suitable for safe monitoring of a movable guard and can lock the safety gate securely.



PSEN me1

PSENmech uses increased extraction force on the actuator to prevent the safety gate from being opened unintentionally. It complies with the standard EN ISO 14119 due to its coded actuators.

Secure safety gate monitoring with guard locking guarantees the safety of personnel and processes. One type of the mechanical safety switch PSEN me1 fulfils two safety functions:

- ▶ Avoids an unexpected start-up when PSEN me1 is unlocked or not closed
- ▶ Safety gate locked by the PSEN me1 while the motor speed is  $> 0$ .

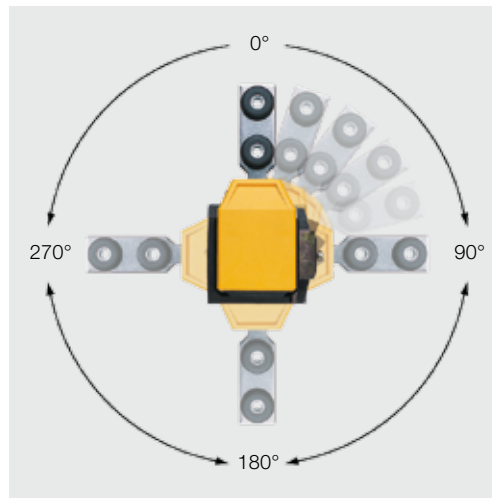

Universal actuation directions provide flexibility during installation.

### Type code for PSENmech

#### PSEN me1.2S/1AR

Product area Pilz SENSors	Product series	Series 1: Type of guard locking/ supply voltage	Series/actuator type
<b>Product range</b> me – PSENmech  <b>Operation</b> Mechanical	<b>1 With guard locking, dimensions:</b> 170 x 42.5 x 51 mm	<b>S</b> Spring force, 24 VAC/DC (2 NC, 2 NO) <b>.2S</b> <b>Spring force, 110, 230 VAC (2 NC, 2 NO)</b> <b>M</b> Magnetic force, 24 VAC/DC (2 NC, 2 NO) <b>.21S</b> Spring force, 110, 230 VAC (3 NC, 1 NO)	<b>1AS</b> Standard, Series 1 <b>1AR</b> Radius, Series 1



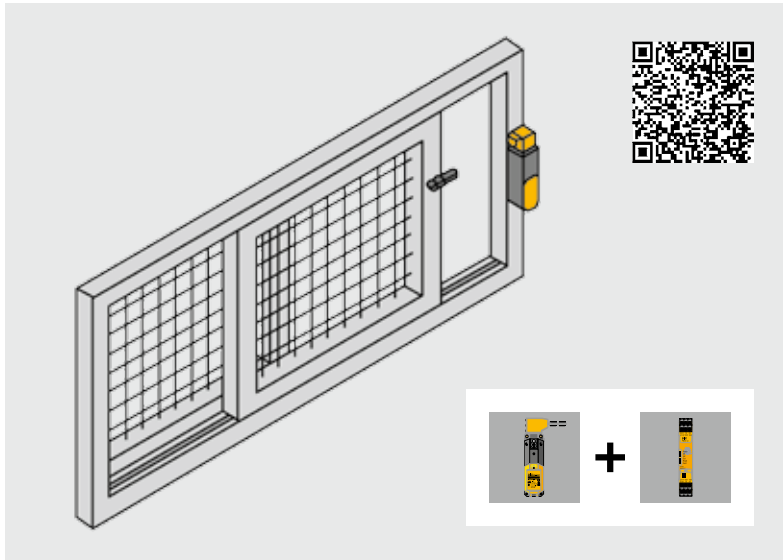

**Your benefits at a glance**

- ▶ Safe, complete solution in conjunction with Pilz evaluation devices for applications with high safety requirements
- ▶ Flexibility and speed during installation due to:
  - Compact design
  - Radius or standard actuator
  - Up to four horizontal and four vertical approach directions
- ▶ Long product service life due to the robust design and high mechanical load capacity
- ▶ Suitable for a variety of applications due to the wide operating temperature range
- ▶ Housing is insensitive to dirt, dust-tight and waterproof

Components for your safe solution	Order number
Sensor: PSEN me1M/1AS	570 004
Connection: Cable, depending on function, e.g. 8 x 0.5 mm <sup>2</sup>	-
Evaluation device: PNOZ s3	751 103

The optimum solution: monitoring sliding gates using the safety switch PSENmech and safety relay PNOZsigma.

Cable and other accessories:

 From page 94



Keep up-to-date on the entire program and on the mechanical safety switch PSENmech:

 Webcode 5174

Online information at [www.pilz.com](http://www.pilz.com)

## ▶ Selection guide – PNOZmech

### Mechanical safety switch PSENmech with separate actuator and guard locking device

#### Common features

- ▶ Safety switch for monitoring the position of movable guards in accordance with EN 60947-5-3
- ▶ Suitable for applications up to:
  - PL e of EN ISO 13849-1
  - SIL CL 3 of EN/IEC 62061
- ▶ Can be connected to all Pilz evaluation devices
- ▶ Directions of actuation:
  - PSEN me1: eight
  - PSEN me3: four
  - PSEN me4: eight
- ▶ Dimensions (H x W x D, excl. actuator):
  - PSEN me1: 170 x 42.5 x 51.0 mm
  - PSEN me3: 90 x 52.0 x 33.0 mm
  - PSEN me4: 100 x 31.0 x 30.5 mm
- ▶ Ambient temperature:
  - PSEN me1: -25 ... +70 °C/-13 ... +158 °F
  - PSEN me3/me4: -30 ... +80 °C/-22 ... +176 °F
- ▶ Connection terminals:
  - PSEN me1: spring-loaded terminals
  - PSEN me3/me4: screw terminals
- ▶ Protection type:
  - PSEN me1: IP67
  - PSEN me3/me4: IP65



PSEN me1S/1AS



PSEN me3/2AR



PSEN me4/4AS

Type (switch/actuator)	Type of guard locking
PSEN me1S/1AS	Spring force
PSEN me1.2S/1AS	Spring force
PSEN me1S/1AR	Spring force
PSEN me1.2S/1AR	Spring force
PSEN me1M/1AS	Magnetic force
PSEN me1M/1AR	Magnetic force
PSEN me1.21S/1AR	Spring force
PSEN me3/2AS	-
PSEN me3.2/2AS	-
PSEN me3.2/2AR	-
PSEN me4.1/4AS	-
PSEN me4.2/4AS	-

Actuator type	Contacts	Supply voltage/contact load Utilisation category AC-15	Auxiliary release	Holding force	Extraction force	Order number (Unit) <sup>1)</sup>
Standard		24 VAC/DC	◆	1 500 N	min. 27 N	570000
Standard		110 ... 230 VAC	◆	1 500 N	min. 27 N	570006
Radius		24 VAC/DC	◆	1 500 N	min. 27 N	570001
Radius		110 ... 230 VAC	◆	1 500 N	min. 27 N	570007
Standard		24 VAC/DC		1 500 N	min. 27 N	570004
Radius		24 VAC/DC		1 500 N	min. 27 N	570005
Radius		110 ... 230 VAC	◆	1 500 N	min. 27 N	570008
Standard		240 V/3.0 A		-	10 N	570210
Standard		240 V/1.5 A		-	10 N	570230
Radius		240 V/1.5 A		-	10 N	570232
Standard		240 V/3.0 A		-	10 N	570245
Standard		240 V/1.5 A		-	10 N	570251

<sup>1)</sup> Unit comprising switch and actuator

<sup>2)</sup> Applies for application of PSEN me1.2



Cable and other accessories:



Technical documentation on the mechanical safety switch PSENmech:

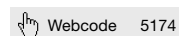

Online information at [www.pilz.com](http://www.pilz.com)

## ► Magnetic safety switch PSENmag

Magnetic safety switches are used both for monitoring the position of guards in accordance with EN 60947-5-3 and for position monitoring. Thanks to economical series connection, PSENmag offers maximum safety at a “low price” and is easily integrated into the existing system environment.

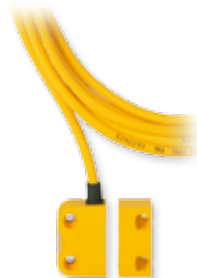

PSEN ma1.4a

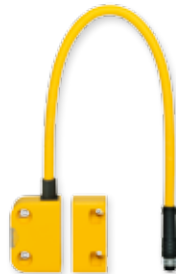

PSEN ma1.4p



PSEN 1.2p



PSEN ma1.3a

### Manipulation protection

The concealed installation of the sensor – as defined in accordance with EN ISO 14119 – prevents manipulation. Other ways of manipulation are excluded if the actuator is secured using safety screws (one-way screws). If the highest manipulation protection is required, we recommend PSENcode due to the RFID technology and the key lock principle.

### High requirements – implemented economically

Use PSENmag wherever a high category is specified, heavy soiling occurs or strict hygiene requirements are to be met.

The rugged, fully encapsulated housing in conjunction with the non-contact, magnetic operating principle guarantees a long product service life.

### Flexible application

The compact design of the PSENmag saves installation space. A large selection of connectors and cables plus an assured operating distance of 3 to 12 mm enable flexible assembly and rapid, simple installation.

### Type code for PSENmag

#### PSEN ma1.4a-50

Product area Pilz SENSors	Contacts	Design	Connection type	Operating distance	LED/ATEX/ Series connection
<b>Product range</b> ma – PSENmag  <b>Operation</b> Non-contact, magnetic	1 NO/NO 2 NC/NO	1 Square, dimensions: 36 x 26 x 13 mm 2 Round, M30 3 Round, M12 4 <b>Rectangular,</b> dimensions: 37 x 26.4 x 18 mm	a <b>Cable, 5 m</b> b Cable, 10 m n Male connector, M12, 5-pin p Connector, M8: - 4-pin (2 contacts) - 8-pin (3 contacts) M12/8 Male connector, M12, 8-pin	1 3 mm 2 8 mm/12 mm <sup>1)</sup> 3 6 mm 4 4 mm 5 <b>3 mm/10 mm <sup>1)</sup></b>	0 <b>Without LED</b> 1 With LED 2 Only with PSEN ix1 <sup>2)</sup> 3 ATEX, without LED 4 ATEX, with LED 5 ATEX, without LED, only with PSEN ix1 <sup>2)</sup> 6 ATEX, without LED 7 With LED, only with PSEN ix1 <sup>2)</sup> 8 ATEX, with LED, only with PSEN ix1 <sup>2)</sup> 9 Special types



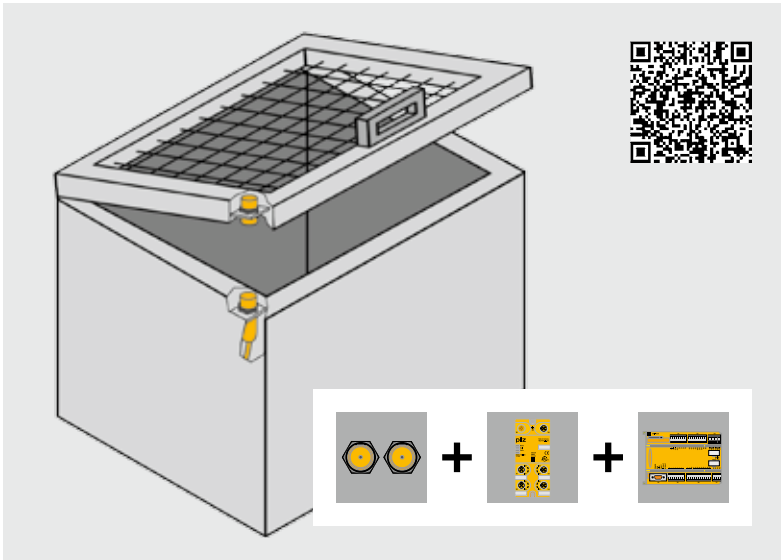

**Your benefits at a glance**

- ▶ Safe complete solution with TÜV certification for applications of the highest categories
- ▶ Economical thanks to:
  - Space and time-saving installation
  - Long product service life as it is mechanically non-wearing
  - User-friendly diagnostics via an additional signal contact and LED
- ▶ Can be used with heavy soiling and strict hygiene regulations IP67/IP6K9K, ECOLAB tested
- ▶ High level of safety, even in potentially explosive areas

Components for your safe solution	Order number
Sensor: PSEN ma1.3n-20/PSEN ma1.3-12	506 238
Connection: PSS67 cable, M12, straight, socket/M12, straight, connector, 5 m	380 209
Decentralized periphery: PDP67 F 8DI ION	773 600
Connection: PSEN cable, straight, M12, 5-pin	630 311
Evaluation device: PNOZmulti	773 100

The optimum solution: monitoring a cover using the PSENmag safety switch and the configurable control system PNOZmulti.

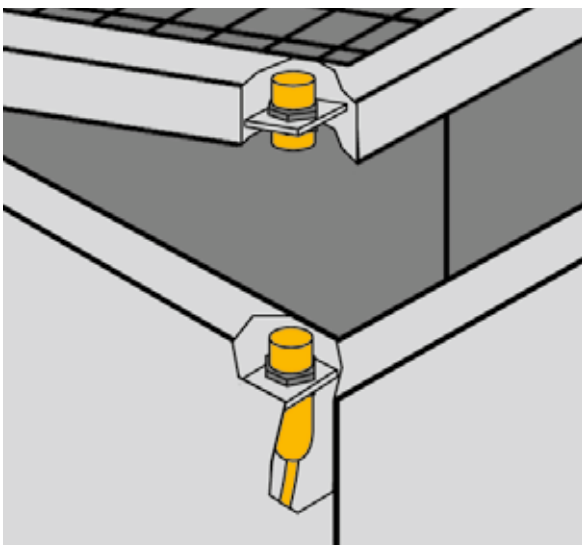

Cable and other accessories:

 From page 94

Keep up-to-date on the non-contact, magnetic safety switch PSENmag:

 Webcode 5179

Online information at [www.pilz.com](http://www.pilz.com)

Possible to protect against manipulation through concealed installation.

## ► Selection guide – PSENmag

### Magnetic safety switch PSENmag – Square design

#### Common features

- ▶ Dual-channel safety switch for monitoring the position of movable guards in accordance with EN 60947-5-3
- ▶ Approved for applications up to Performance Level e of EN ISO 13849-1 and SIL CL 3 of EN/IEC 62061 in conjunction with safety relays PNOZ s3, PNOZ s4, PNOZ s5, PNOZ e1p, PNOZ e1.1p, PNOZ e1vp, PNOZ e5.11p
- ▶ Optional signal contact
- ▶ Direct connection, via PDP67, PDP20 or via the interface PSEN ix1, see accessories from page 94
- ▶ Protection type:
  - Cable versions: IP6K9K
  - Connector versions: IP67
- ▶ Flexible installation due to the housing design and pigtail cable
- ▶ Protective caps included for better manipulation protection

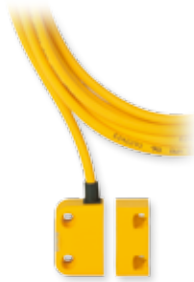

PSEN ma1.4a



PSEN ma1.4p

Type (switch/actuator)	Assured operating distance
PSEN ma1.4a-50/PSEN ma1.4-10	10 mm
PSEN ma1.4a-51/PSEN ma1.4-10	10 mm
PSEN ma1.4a-52/PSEN ma1.4-10	10 mm
PSEN ma1.4a-57/PSEN ma1.4-10	10 mm
PSEN ma1.4p-50/PSEN ma1.4-10	10 mm
PSEN ma1.4p-51/PSEN ma1.4-10	10 mm
PSEN ma1.4p-52/PSEN ma1.4-10	10 mm
PSEN ma1.4p-57/PSEN ma1.4-10	10 mm
PSEN ma1.4n-50/PSEN ma1.4-10	10 mm
PSEN ma1.4n-51/PSEN ma1.4-10	10 mm
PSEN ma1.4-51M12/8-0.15m/ PSEN ma1.4-10	10 mm
PSEN ma1.4a-57/PSEN ma1.4-03	3 mm
PSEN ma1.4a-50/PSEN ma1.4-03	3 mm
PSEN ma1.4a-51/PSEN ma1.4-03	3 mm
PSEN ma1.4a-52/PSEN ma1.4-03	3 mm
PSEN ma1.4p-50/PSEN ma1.4-03	3 mm
PSEN ma1.4p-51/PSEN ma1.4-03	3 mm
PSEN ma1.4p-57/PSEN ma1.4-03	3 mm
PSEN ma1.4p-52/PSEN ma1.4-03	3 mm
PSEN ma1.4n-50/PSEN ma1.4-03	3 mm
PSEN ma1.4n-51/PSEN ma1.4-03	3 mm
PSEN ma1.4-51M12/8-0.15m/ PSEN ma1.4-03	3 mm
PSEN 1.1p-23/PSEN 1.1-20	8 mm
PSEN 1.1p-25/PSEN 1.1-20	8 mm

Contacts	Single connection	Series connection via	LED	ATEX	Connection type Cable/connector	Order number (Unit) <sup>1)</sup>
	◆	-			5 m	506322
	◆	-	◆		5 m	506326
		PSEN ix1			5 m	506323
		PSEN ix1	◆		5 m	506327
	◆	-			M8, 4-pin, pigtail, 25 cm	506334
	◆	-	◆		M8, 8-pin, pigtail, 25 cm	506338
		PSEN ix1			M8, 4-pin, pigtail, 25 cm	506335
		PSEN ix1	◆		M8, 8-pin, pigtail, 25 cm	506339
	◆	PDP67			M12, 5-pin, pigtail, 15 cm	506342
	◆	PDP67	◆		M12, 5-pin, pigtail, 15 cm	506343
	◆	-	◆		M12, 8-pin, pigtail, 15 cm	506345
		PSEN ix1	◆		5 m	506325
	◆	-			5 m	506320
	◆	-	◆		5 m	506324
		PSEN ix1			5 m	506321
	◆	-			M8, 4-pin, pigtail, 25 cm	506332
	◆	-	◆		M8, 8-pin, pigtail, 25 cm	506336
		PSEN ix1	◆		M8, 8-pin, pigtail, 25 cm	506337
		PSEN ix1			M8, 4-pin, pigtail, 25 cm	506333
	◆	PDP67			M12, 5-pin, pigtail, 25 cm	506340
	◆	PDP67			M12, 5-pin, pigtail, 25 cm	506341
	◆	-	◆		M12, 8-pin, pigtail, 15 cm	506344
	◆	-		◆	M8, 4-pin	504223
		PSEN ix1		◆	M8, 4-pin	504225

<sup>1)</sup> Unit comprising switch and actuator



Cable and other accessories:

From page 94

Technical documentation on the magnetic safety switch PSENmag:

Webcode 5179

Online information at [www.pilz.com](http://www.pilz.com)

## ► Selection guide – PSENmag

### Magnetic safety switch PSENmag – Round design

#### Common features

- Dual-channel safety switch for monitoring the position of movable guards in accordance with EN 60947-5-3
- Approved for applications up to Performance Level e of EN ISO 13849-1 and SIL CL 3 of EN/IEC 62061 in conjunction with safety relays PNOZ s3, PNOZ s4, PNOZ s5, PNOZ e1p, PNOZ e1.1p, PNOZ e1vp, PNOZ e5.11p
- With signal contact
- Direct connection, via PDP67, PDP20 or via the interface PSEN ix1, see accessories from page 94
- Protection type:
  - Cable versions: IP67
  - Connector versions: IP67



Type (switch/actuator)	Assured operating distance
► M12 housing	
PSEN ma1.3a-20/PSEN ma1.3-08	8 mm
PSEN ma1.3a-22/PSEN ma1.3-08	8 mm
PSEN ma1.3b-20/PSEN ma1.3-08	8 mm
PSEN ma1.3b-22/PSEN ma1.3-08	8 mm
PSEN ma1.3p-20/PSEN ma1.3-08	8 mm
PSEN ma1.3n-20/PSEN ma1.3-08	8 mm
PSEN ma1.3-20M12/8-0.15m/ PSEN ma1.3-08	8 mm
PSEN ma1.3p-22/PSEN ma1.3-08	8 mm
PSEN ma1.3b-23/PSEN ma1.3-08	8 mm
PSEN ma1.3b-25/PSEN ma1.3-08	8 mm
PSEN ma1.3a-20/PSEN ma1.3-12	12 mm
PSEN ma1.3a-22/PSEN ma1.3-12	12 mm
PSEN ma1.3b-20/PSEN ma1.3-12	12 mm
PSEN ma1.3b-22/PSEN ma1.3-12	12 mm
PSEN ma1.3p-20/PSEN ma1.3-12	12 mm
PSEN ma1.3n-20/PSEN ma1.3-12	12 mm
PSEN ma1.3-20M12/8-0.15m/ PSEN ma1.3-12	12 mm
PSEN ma1.3p-22/PSEN ma1.3-12	12 mm
PSEN ma1.3b-23/PSEN ma1.3-12	12 mm
PSEN ma1.3b-25/PSEN ma1.3-12	12 mm

Contacts	Single connection	Series connection via	LED	ATEX	Connection type Cable/connector	Order number (Unit) <sup>1)</sup>
Y Y Y	◆	-	◆		5 m	506220
Y Y Y		PSEN ix1	◆		5 m	506221
Y Y Y	◆	-	◆		10 m	506222
Y Y Y		PSEN ix1	◆		10 m	506223
Y Y Y	◆	-	◆		M8, 8-pin, pigtail, 25 cm	506226
Y Y Y	◆	PDP67	◆		M12, 5-pin, pigtail, 15 cm	506228
Y Y Y	◆	-	◆		M12, 8-pin, pigtail, 15 cm	506229
Y Y Y		PSEN ix1	◆		M8, 8-pin, pigtail, 25 cm	506227
Y Y Y	◆	-	◆	◆	10 m	506224
Y Y Y		PSEN ix1	◆	◆	10 m	506225
Y Y Y	◆	-	◆		5 m	506230
Y Y Y		PSEN ix1	◆		5 m	506231
Y Y Y	◆	-	◆		10 m	506232
Y Y Y		PSEN ix1	◆		10 m	506233
Y Y Y	◆	-	◆		M8, 8-pin, pigtail, 25 cm	506236
Y Y Y	◆	PDP67	◆		M12, 5-pin, pigtail, 25 cm	506238
Y Y Y	◆	-	◆		M12, 8-pin, pigtail, 15 cm	506239
Y Y Y		PSEN ix1	◆		M8, 8-pin, pigtail, 25 cm	506237
Y Y Y	◆	-	◆	◆	10 m	506234
Y Y Y		PSEN ix1	◆	◆	10 m	506235

<sup>1)</sup> Unit comprising switch and actuator



Cable and other accessories:

From page 94

Technical documentation on the magnetic safety switch PSENmag:

Webcode 5179

Online information at [www.pilz.com](http://www.pilz.com)



## ▶ Coded safety switch PSENcode

The non-contact, coded safety switch PSENcode is used both for monitoring the position of guards in accordance with EN 60947-5-3 and simple position monitoring.



PSEN cs5.1p



PSEN cs4.1p



PSEN cs1.1p

### Highest level of manipulation protection in the smallest space

With PSENcode you have the smallest, coded safety switch with integrated evaluation and built-in manipulation protection thanks to RFID technology.

In the unique, fully coded version, PSENcode has the highest level of manipulation protection: the sensor only accepts a single actuator (key lock principle).

The coded PSENcode is accepted by other PSENcode actuators. The fully coded PSENcode only accepts one actuator. In contrast to the unique, fully coded safety switch, it's possible to teach-in a new actuator on the switch retrospectively.

### Position monitoring with distinction

When several positions need to be monitored and also distinguished safely, PSENcode x.19n is the right choice (from page 34).

### Type code for PSENcode

#### PSEN cs2.13p

Product area Pilz SENSors	Coding/design	Additional functions	Connection type
<b>Product range cs – PSENcode</b>  <b>Operation</b> ▶ Non-contact, coded ▶ Transponder (RFID) ▶ With safe semiconductor outputs	1.1 Coded, large design 2.1 <b>Fully coded, large design</b> 2.2 Unique, fully coded, large design 3.1 Coded, compact design 4.1 Fully coded, compact design 4.2 Unique, fully coded, compact design 5.1 Coded, slimline design 6.1 Fully coded, slimline design 6.2 Unique, fully coded, slimline design	_ Without ATEX 1 With magnetic latching 3 <b>With ATEX</b> 9 With max. three actuators	a ▶ Cable, 5 m <sup>1)</sup> b ▶ Cable, 10 m <sup>1)</sup> n ▶ Male connector, M12, 5-pin p ▶ <b>Connector, M12, 8-pin (large design)</b> ▶ <b>Connector, M8, 8-pin (compact, slimline design)</b> M12 ▶ Connector, M12, 8-pin (compact, slimline design)

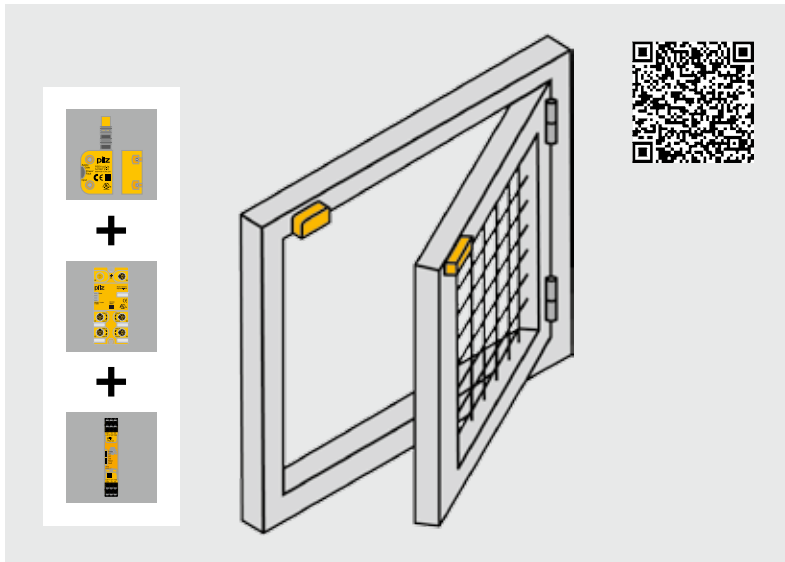

**Your benefits at a glance**

- ▶ Highest level of safety and plant availability
- ▶ Highest manipulation protection offers maximum freedom in installation
- ▶ Simple project configuration, as the unit is highly versatile:
  - Insensitive to shock and vibration
  - Can be used with heavy soiling and strict hygiene regulations IP67/IP6K9K
  - Flexible installation
- ▶ Economical:
  - Space-saving installation due to the compact housing
  - Highest level of safety even when connected in series with PSENcode, PSENIini, PSENslock and PSENsgate

Components for your safe solution	Order number
Sensor: PSEN cs4.2 M12, 8-pin, 0.15 m/PSEN cs4.1	541 209
Connection: PSEN cable, M12, 8-pin, straight, connector/M12, 8-pin, straight, connector, 5 m	540 341
Decentralized periphery: PDP67 F 4 code	773 603
Connection: PDP67 cable, M12, 8-pin, straight, connector, 30 m	380 704
Evaluation device: PNOZ s3	751 103

The optimum solution: monitoring swing gates using the safety switch PSENcode and safety relay PNOZsigma.

**Simple implementation saves time and money**

Save costs, from project configuration through to commissioning: used in conjunction with Pilz control technology, PSENcode provides a complete, co-ordinated solution that's economical and safe.

Thanks to integrated evaluation and standard interfaces, PSENcode is open to products from other manufacturers. It fits perfectly into your environment and can be used to upgrade your plant.



High flexibility due to multiple actuation directions (PSEN cs1/PSEN cs5), multiple mounting configurations (PSEN cs3/PSEN cs5) for the actuators and compact/slimline design (PSEN cs3/PSEN cs5).

Keep up-to-date on the coded safety switch PSENcode:

 Webcode 5184

Online information at [www.pilz.com](http://www.pilz.com)

## ► Selection guide – PSENcode



### Common features

- Safety switch for monitoring the position of movable guards
- Approved for applications up to PL e of EN ISO 13849-1, up to SIL CL 3 of EN/IEC 62061
- Integrated evaluation and standard interfaces (OSSD) for connection to evaluation devices from Pilz or other manufacturers
- Series connection with PSENcode, PSENIini, PSENslock and PSENsgate approved up to PL e of EN ISO 13849-1, up to SIL CL 3 of EN/IEC 62061
  - With 8-pin connector via Y junction (cable separator) or PDP67 F 4 code
  - With 5-pin connector via PDP67 F 8DI ION
- Protection type:
  - Cable version: IP6K9K
  - Connector version: IP67
- Diagnostic interface with 3 LEDs
- Outputs: 2 safety outputs and 1 signal output
- Housing form:
  - PSEN cs1/PSEN cs2: 75 x 40 x 40 mm
  - PSEN cs3/PSEN cs4: 37 x 26 x 18 mm
  - PSEN cs5p/PSEN cs6p: 98 x 26 x 13 mm
  - PSEN cs5n/PSEN cs6n: 98 x 26 x 19 mm
- Drill hole spacing:
  - PSEN cs3/PSEN cs4: 22 mm
  - PSEN cs5/PSEN cs6: 22 mm
- Sensing faces:
  - PSEN cs1/PSEN cs2: 4
  - PSEN cs3/PSEN cs4: 1
  - PSEN cs5/PSEN cs6: 4
- Typical operating distance:
  - PSEN cs1/PSEN cs2: 21 mm
  - PSEN cs3/PSEN cs4: 11 mm
  - PSEN cs5/PSEN cs6: 11 mm, 5 mm, 10 mm (M8 connection) or 7 mm (M12 connection)
- Magnetic latching PSEN cs5.11/ PSEN cs6.11/PSEN cs6.21: Typ. 25 N

### Coded safety switch PSENcode with 8-pin connector and integrated series



PSEN cs1.1p



PSEN cs4.1a



PSEN cs5.1p

Type (switch/actuator)
PSEN cs1.1p/PSEN cs1.1
PSEN cs1.13p/PSEN cs1.1
PSEN cs2.1p/PSEN cs2.1
PSEN cs2.13p/PSEN cs2.1
PSEN cs2.2p/PSEN cs2.1
PSEN cs3.1 M12/8-0.15m/PSEN cs3.1
PSEN cs3.1 M12/8-1.5m/PSEN cs3.1
PSEN cs3.1a/PSEN cs3.1
PSEN cs3.1p/PSEN cs3.1
PSEN cs4.1 M12/8-0.15m/PSEN cs4.1
PSEN cs4.1a/PSEN cs4.1
PSEN cs4.1p/PSEN cs4.1
PSEN cs4.2 M12/8-0.15m/PSEN cs4.1
PSEN cs4.2a/PSEN cs4.1
PSEN cs4.2p/PSEN cs4.1
PSEN cs5.1 M12/8/PSEN cs5.1 M12
PSEN cs5.1p/PSEN cs5.1
PSEN cs5.11 M12/8/PSEN cs5.11 M12
PSEN cs6.1 M12/8/PSEN cs6.1 M12
PSEN cs6.1p/PSEN cs6.1
PSEN cs6.11 M12/8/PSEN cs6.11 M12
PSEN cs6.2 M12/8/PSEN cs6.1 M12
PSEN cs6.2p/PSEN cs6.1
PSEN cs6.21 M12/8/PSEN cs6.11 M12

### Coded safety switch PSENcode with 5-pin connector for PDP67 F 8DI ION



PSEN cs3.1n

Type (switch/actuator)
PSEN cs1.1n/PSEN cs1.1
PSEN cs2.1n/PSEN cs2.1
PSEN cs2.2n/PSEN cs2.1
PSEN cs3.1n/PSEN cs3.1
PSEN cs4.1n/PSEN cs4.1
PSEN cs4.2n/PSEN cs4.1
PSEN cs5.1n/PSEN cs5.1 M12
PSEN cs6.1n/PSEN cs6.1 M12
PSEN cs6.2n/PSEN cs6.1 M12

connection

Type of coding	Size	Additional functions	Connection type	Order number (Unit) <sup>2)</sup>
Coded <sup>3)</sup>	Large	-	Connector, M12, 8-pin	540 000
Coded <sup>3)</sup>	Large	With ATEX	Connector, M12, 8-pin	540 005
Fully coded <sup>4)</sup>	Large	-	Connector, M12, 8-pin	540 100
Fully coded <sup>4)</sup>	Large	With ATEX	Connector, M12, 8-pin	540 105
Unique, fully coded <sup>5)</sup>	Large	-	Connector, M12, 8-pin	540 200
Coded <sup>3)</sup>	Compact	-	Connector, M12, 8-pin, pigtail, 15 cm	541 009
Coded <sup>3)</sup>	Compact	-	Connector, M12, 8-pin, pigtail, 1.5 m	541 014
Coded <sup>3)</sup>	Compact	-	Cable, 5 m	541 011
Coded <sup>3)</sup>	Compact	-	Connector, M8, 8-pin	541 010
Fully coded <sup>4)</sup>	Compact	-	Connector, M12, 8-pin, pigtail, 15 cm	541 109
Fully coded <sup>4)</sup>	Compact	-	Cable, 5 m	541 111
Fully coded <sup>4)</sup>	Compact	-	Connector, M8, 8-pin, pigtail, 15 cm	541 110
Unique, fully coded <sup>5)</sup>	Compact	-	Connector, M12, 8-pin, pigtail, 15 cm	541 209
Unique, fully coded <sup>5)</sup>	Compact	-	Cable, 5 m	541 211
Unique, fully coded <sup>5)</sup>	Compact	-	Connector, M8, 8-pin, pigtail, 15 cm	541 210
Coded <sup>3)</sup>	Slimline	-	Connector, M12, 8-pin	542 009
Coded <sup>3)</sup>	Slimline	-	Connector, M8, 8-pin	542 000
Coded <sup>3)</sup>	Slimline	Magnetic latching	Connector, M12, 8-pin	542 011
Fully coded <sup>4)</sup>	Slimline	-	Connector, M12, 8-pin	542 109
Fully coded <sup>4)</sup>	Slimline	-	Connector, M8, 8-pin	542 100
Fully coded <sup>4)</sup>	Slimline	Magnetic latching	Connector, M12, 8-pin	542 111
Unique, fully coded <sup>5)</sup>	Slimline	-	Connector, M12, 8-pin	542 209
Unique, fully coded <sup>5)</sup>	Slimline	-	Connector, M8, 8-pin	542 200
Unique, fully coded <sup>5)</sup>	Slimline	Magnetic latching	Connector, M12, 8-pin	542 211



Type of coding	Size	Additional functions	Connection type	Order number (Unit) <sup>2)</sup>
Coded <sup>3)</sup>	Large	-	Connector, M12, 5-pin	540 003
Fully coded <sup>4)</sup>	Large	-	Connector, M12, 5-pin	540 103
Unique, fully coded <sup>5)</sup>	Large	-	Connector, M12, 5-pin	540 203
Coded <sup>3)</sup>	Compact	-	Connector, M12, 5-pin, pigtail, 15 cm	541 003
Fully coded <sup>4)</sup>	Compact	-	Connector, M12, 5-pin, pigtail, 15 cm	541 103
Unique, fully coded <sup>5)</sup>	Compact	-	Connector, M12, 5-pin, pigtail, 15 cm	541 203
Coded <sup>3)</sup>	Slimline	-	Connector, M12, 5-pin	542 003
Fully coded <sup>4)</sup>	Slimline	-	Connector, M12, 5-pin	542 103
Unique, fully coded <sup>5)</sup>	Slimline	-	Connector, M12, 5-pin	542 203

Cable and other accessories:

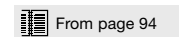

Technical documentation on the coded safety switch PSENcode:

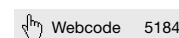

Online information at [www.pilz.com](http://www.pilz.com)

<sup>1)</sup> For all PSEN cs3/cs4 <sup>2)</sup> Unit comprising switch and actuator  
<sup>3)</sup> Coded = Switch accepts any PSENcode actuator  
<sup>4)</sup> Fully coded = Switch accepts only one PSENcode actuator, teach-in up to 8 times  
<sup>5)</sup> Unique, fully coded = Switch accepts only one PSENcode actuator, no teach-in facility

## ▶ Coded safety switch PSEncode for position mon

Three positions – one safe sensor: one coded safety switch type is suitable for monitoring up to three positions safely. In this economical solution, PSEncode also distinguishes safely between positions.



IP67



PSEN cs3.19n



PSEN cs1.19n

The coded safety switch PSEN csx.19n enables quick, user-friendly diagnostics via LED display, whether you use the compact or the large design. Thanks to the connection type (M12 connector, 5-pin), the new PSEncode fits perfectly into any system environment.

### Solution for standard and safety

Previously, two standard proximity switches and one safe sensor were necessary to monitor three positions within an application. The coded safety switch PSEN csx.19n enables a more efficient solution because it can replace two standard sensors. The coded safety switch PSEncode simplifies the application considerably. Actuator arms, sensor wiring and I/O channels are surplus to requirements, as are proximity switches. As a result you can reduce the costs and effort involved in standard and safety-related position detection.

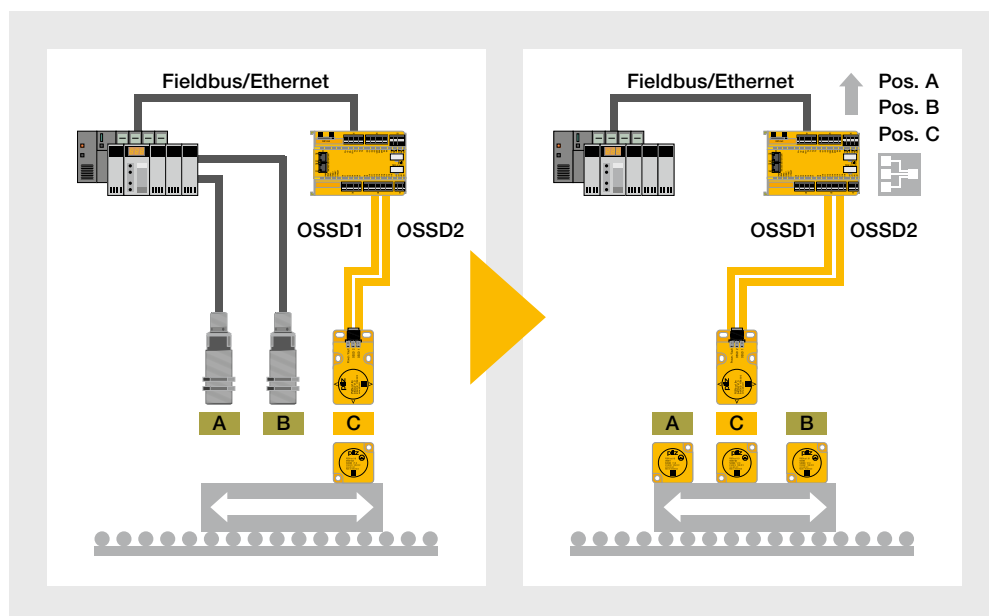

PSEncode offers great potential savings as a solution for standard and safety.



# Monitoring

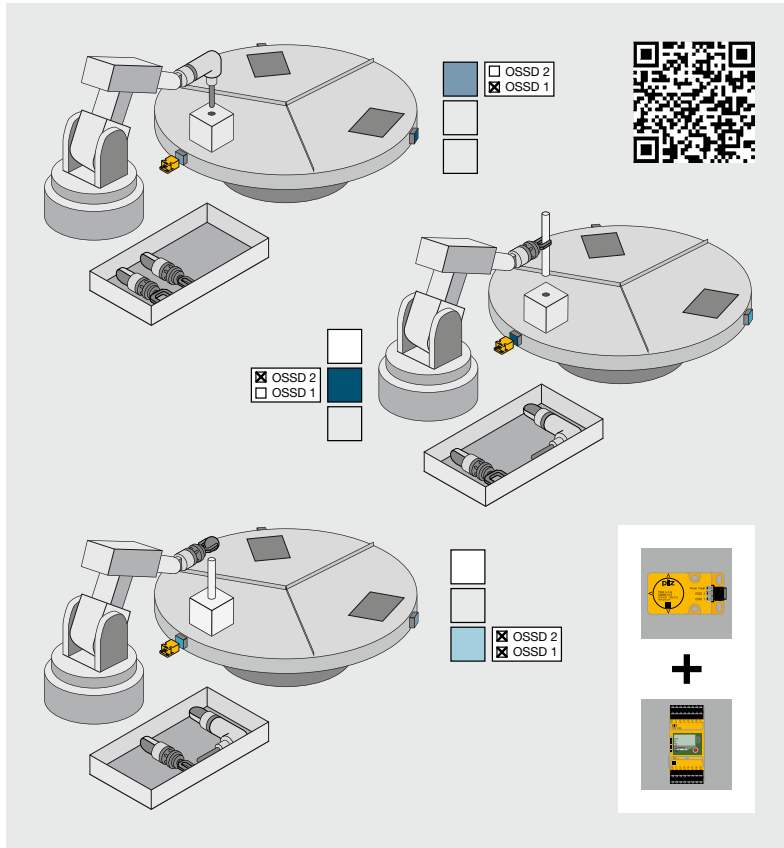

### Your benefits at a glance

- ▶ Economical solution, as only one sensor is required to monitor three positions safely
- ▶ Reduced costs thanks to safe inputs on the evaluation device and cable accessories
- ▶ Clear LED display enables rapid diagnostics
- ▶ Long product service life thanks to non-contact action principle
- ▶ Safe, complete solution: when combined with the configurable small control system PNOZmulti Mini
- ▶ Simple configuration with the software module in the PNOZmulti Configurator

Components for your safe solution	Order number
Sensor: PSEN cs1.19n/PSEN cs1.19	540 303
Connection: PSEN cable, M12, 5-pin, 3 m	630 310
Evaluation device: PNOZ mm0p	772 000
Spring-loaded terminals (1 set)	751 008

The optimum solution: monitoring positions using the safety switch PSENcode and configurable small control system PNOZmulti Mini.

Actuator used	Achievable safety level in accordance with EN ISO 13849-1 (per actuator)		
	OSSD 1&2	OSSD 1	OSSD 2
OSSD 1&2	PL e	-	-
OSSD 1, OSSD 2	-	PL d <sup>1)</sup>	PL d <sup>1)</sup>
OSSD 1&2, OSSD 1, OSSD 2	PL d <sup>1)</sup>	PL c	PL c

<sup>1)</sup> With additional diagnostics, stuck-at-faults and wiring errors such as short circuits and shorts across contacts are detected. (Feasibility check)

Keep up-to-date on the coded safety switch PSENcode:

 Webcode 5184

Online information at [www.pilz.com](http://www.pilz.com)

## ► Selection guide – PSENcode for position monito

### Coded safety switch PSENcode – Sets



PSEN cs1.19n/...

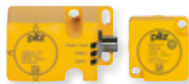

PSEN cs1.19n/...



PSEN cs3.19n/...

Type	Features
<b>PSEN cs1.19n/PSEN cs1.19</b>	<ul style="list-style-type: none"> <li>▶ Mode of operation: RFID transponder technology</li> <li>▶ Type of coding: coded</li> <li>▶ Diagnostic interface: 3 LEDs (active actuator, supply voltage/fault)</li> <li>▶ Connection: connector M12, 5-pin</li> <li>▶ Design: compact or large</li> </ul>
<b>PSEN cs3.19n/PSEN cs3.19</b>	<ul style="list-style-type: none"> <li>▶ Outputs: 2 safety outputs</li> <li>▶ Inputs: 2 safety inputs</li> <li>▶ Protection type: IP67</li> </ul>

### Coded safety switch PSENcode



PSEN cs3.19n – 1switch



PSEN cs1.19 – OSSD 1 – 1actuator

Type	Order number
<b>PSEN cs1.19n – 1switch</b>	540353
<b>PSEN cs1.19 – OSSD 1&amp;2 – 1actuator</b>	540380
<b>PSEN cs1.19 – OSSD 1 – 1actuator</b>	540382
<b>PSEN cs1.19 – OSSD 2 – 1actuator</b>	540383
<b>PSEN cs3.19n – 1switch</b>	541353
<b>PSEN cs3.19 – OSSD 1&amp;2 – 1actuator</b>	541380
<b>PSEN cs3.19 – OSSD 1 – 1actuator</b>	541382
<b>PSEN cs3.19 – OSSD 2 – 1actuator</b>	541383

ring

Actuator minimum distance		Actuation directions	Typical operating distance	Order number		
between 2 actuators	between 2 sensors			Sensor with 3 actuators (OSSD 1, OSSD 2, OSSD 1&2)	Sensor with 2 actuators (OSSD 1, OSSD 2)	Sensor with 1 actuator (OSSD 1&2)
40 mm	400 mm	4	11 mm	540 303	540 305	540 304
20 mm	100 mm	1	15 mm	541 303	541 305	541 304



Cable and other accessories:

 From page 94

Technical documentation on the coded safety switch PSENcode:

 Webcode 5184

Online information at [www.pilz.com](http://www.pilz.com)

## ► Safety bolt PSEnbolt

In conjunction with Pilz safe control technology, the safety bolt PSEnbolt offers you the safe, complete solution comprising safety switch, handle and bolt. This removes the need for expensive in-house engineering.



PSEN b5  
(with PSEN cs4/PSEN me1)

### The combinable solution for secure safety gate monitoring

PSEnbolt is particularly suitable for safety gates that are difficult to adjust or in areas where safety gates are often opened and closed frequently, because as well as protection against defeat and manipulation protection, long life of the material is also guaranteed.

### Longer service life for the integrated safety switch

The actuator is guided into the actuator head of the safety switch PSEN me1 mechanically. This guarantees that the actuator is inserted correctly into the safety switch when the guard is closed. At the same time it provides mechanical protection for the switch.

As a combination of two safety switches, the safety bolt PSEnbolt enables secure safety gate monitoring with the coded safety switch PSENcode up to the highest category PL e of EN ISO 13849-1 / SIL CL 3 of EN/IEC 62061 and safe guard locking with the mechanical safety switch PSENmech in one.

### Type code for PSEnbolt

#### PSEN b4.1

Product area Pilz SENSors	Escape release/locking pin	Can be combined with
<b>Product range b – PSEnbolt</b>  <b>Operation</b> Depends on the selected safety switch:  ► Mechanical ► Magnetic ► Coded	1 Without escape release, without locking pin	► Mechanical safety switches PSENmech with guard locking (PSEN me1 series) ► Non-contact, coded safety switches PSENcode (series PSEN cs1, PSEN cs2)
	2 With escape release, with locking pin, can be deactivated	
	2.1 With escape release, with locking pin, cannot be deactivated	
	3 Without escape release, without locking pin	► Non-contact, coded safety switches PSENcode (series PSEN cs3, PSEN cs4)
	4 With escape release, with locking pin, can be deactivated	
<b>4.1 With escape release, with locking pin, cannot be deactivated</b>		
5 Without escape release, without locking pin	► Mechanical safety switch PSEN me1 and non-contact, coded safety switches PSENcode (PSEN cs3, PSEN cs4)	

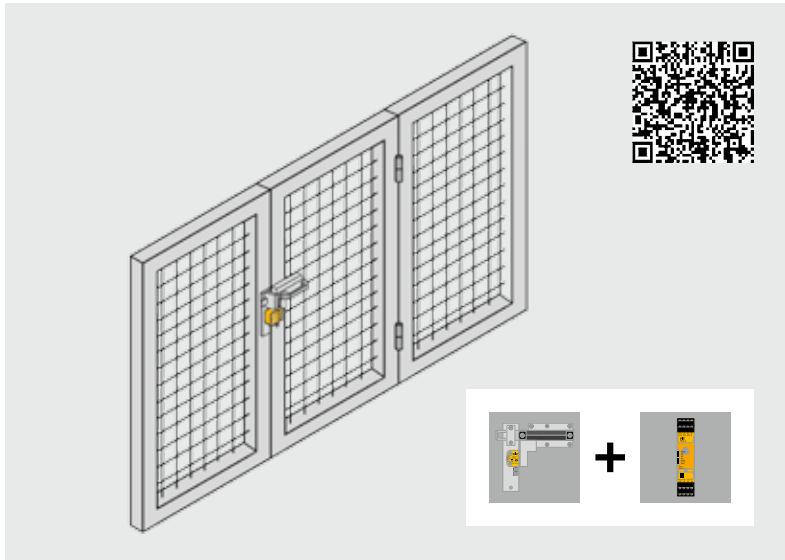

**Your benefits at a glance**

- ▶ Reduced development and installation expense
- ▶ Cost-optimized solution comprising safety switch, handle and bolt:
  - Simple combination of up to two switches
  - Long-lasting thanks to mechanical protection for safety switch
  - Reduced installation work thanks to a terminal that secures the cable (PSEN b5)
  - Highest manipulation protection and protection against defeat with safety switches PSENcode (RFID)
- ▶ Escape release available as an option
- ▶ High availability: locking pin protects the bolt from closing unintentionally

Components for your safe solution	Order number
Sensor: PSEN b4.1 combined with PSEN cs4.1n/PSEN cs4.1	540041 541103
Connection: PSEN cable, M12, 5-pin, 5 m	630311
Evaluation device: PNOZ s4	751104

The optimum solution: monitoring swing gates using the safety bolt PSEnbolt with PSENcode and safety relay PNOZsigma.

**Selection guide – Safety bolt PSEnbolt**

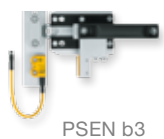
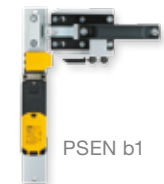

Type	Can be combined with	Escape release	Locking pin	Order number <sup>3)</sup>
PSEN b1	▶ PSEN me1			540010
PSEN b2	▶ PSEN cs1 ▶ PSEN cs2	◆	◆ <sup>1)</sup>	540020
PSEN b2.1		◆	◆ <sup>2)</sup>	540021
PSEN b3	▶ PSEN cs3			540030
PSEN b4	▶ PSEN cs4	◆	◆ <sup>1)</sup>	540040
PSEN b4.1		◆	◆ <sup>2)</sup>	540041
PSEN b5	▶ PSEN me1 ▶ PSEN cs3 ▶ PSEN cs4			540015

1) Can be deactivated  
 2) Cannot be deactivated  
 3) Order number for handle and bolt

Approvals depend on the selected safety switch

Cable and other accessories:

From page 94

Latest information and technical documentation on the safety bolt PSEnbolt:

Webcode 5191

Online information at [www.pilz.com](http://www.pilz.com)



## ▶ Safe hinge switch PSEnhinge

Safe hinge switches PSEnhinge provide a safe, complete solution for guards, comprising hinge and safety switch. Enjoy the benefits of a safe, complete solution in conjunction with Pilz control technology.



PSEN hs1.1p

### For guards

PSEnhinge is suitable for rotatable and hinged gates as well as flaps. High manipulation protection is achieved by concealing the installation within the guard. Safe hinge switches from Pilz can also be used where there is heavy soiling, as they conform to protection type IP67.

### With re-adjustable switching point

Designed as one functional and installation unit, PSEnhinge offer a high level of flexibility in installation, connection and adjustment. They allow systems to be attached to the right or left, for optimum cable feed at a switching point between 0° and 270°. Even after setting the switching point, the user can still correct the setting of the hinge with the integrated precision adjustment system.

### Maximum flexibility

The change kit can be used to redefine the switching point when the plant is upgraded.

### Type code for PSEnhinge

#### PSEN hs1.1p

<b>Product area</b> Pilz SENsors	<b>Contacts</b>	<b>Door stop</b>	<b>Connection</b>
<b>Product range</b> hs – PSEnhinge	1 NC/NC	1 Right 2 Left	p Male connector, M12, 4-pin (compatible with M12, 5-pin)
<b>Operation</b> Mechanical			

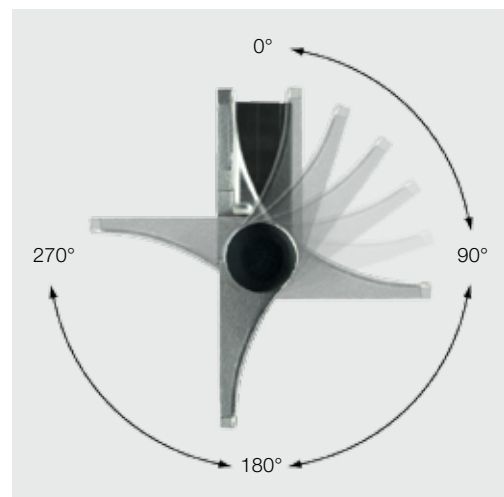

High level of flexibility for the design: the switching point on PSEnhinge can be set between 0° and 270°.

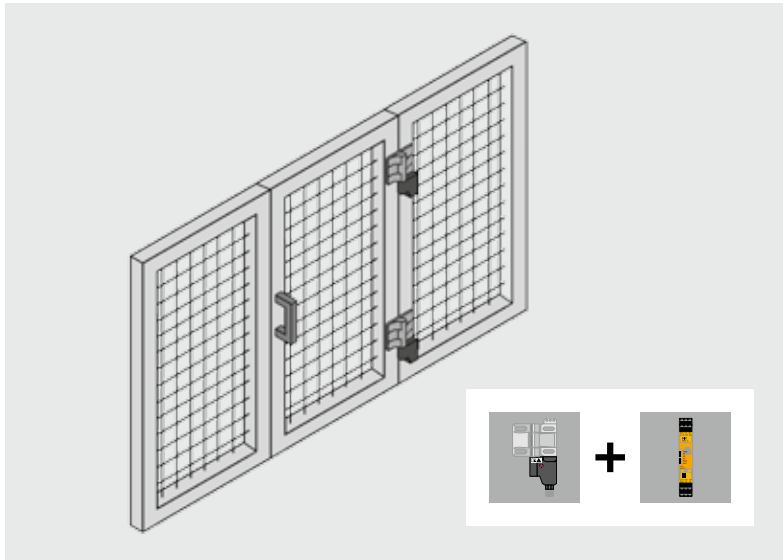

Components for your safe solution	Order number
Sensor: PSEN hs1.1p	570 270
Connection: PSEN cable, M12, 4-pin, 5 m	630 301
Evaluation device: PNOZ s3	751 103

The optimum solution: monitoring swing gates safely using the hinge switches PSEnhinge and safety relay PNOZsigma.

**Selection guide – Safe hinge switch PSEnhinge**



PSEN hs1.1p

Type	Door stop	Order number <sup>1)</sup>
PSEN hs1.1p	Right	570 270
PSEN hs1.2p	Left	570 271

<sup>1)</sup> Order number for hinge and safety switch

**Common features**

- ▶ Hinge switches for monitoring the position of movable guards in accordance with EN 60947-5-3
- ▶ Can be used in applications up to PL e of EN ISO 13849-1, SIL CL 3 of EN/IEC 62061 if two switches are used
- ▶ Connection type: Male connector, M12, 4-pin
- ▶ Contacts: 2 NC
- ▶ Protection type: IP67
- ▶ Plastic-bodied design

**Your benefits at a glance**

- ▶ Safe, complete solution for rotatable/hinged guards, comprising hinge and safety switch
- ▶ In conjunction with Pilz control systems, can be used for applications with high safety requirements
- ▶ Manipulation-proof and space-saving, as it's integrated directly within the safeguard
- ▶ Highest flexibility in installation, connection and adjustment:
  - Switching point is free to set from 0° to 270° and is re-adjustable
  - Protection type IP67
- ▶ User-friendly:
  - Slot fastening for mounting on profiles
  - Simple readjustment by means of integrated precision adjustment system
  - Systems can be attached to right and left
- ▶ Low maintenance:
  - Rugged version for high mechanical loads
  - Resistant to soiling



Accessories: blank hinge and change kit

From page 111

Latest information and technical documentation on safe hinge switches PSEnhinge:

Webcode 6574

Online information at [www.pilz.com](http://www.pilz.com)

## ► Safety gate systems

Safety gate systems are used for guard protection. If a guard is opened, hazardous machine movements must be brought to a stop in accordance with EN ISO 14119 and a restart must be prevented (interlocking). It must not be possible to either defeat or manipulate the guards.



PSEN sl-1.0p



PSEN sg2c-3LPE

Pilz safety gate systems are particularly effective in meeting this requirement and incorporate additional functionalities for greater economy:

- PSENslock – Safety gate monitoring with process guarding
- PSENsgate – Safety gate monitoring with safe guard locking and control elements



**Selection guide and distinction between safety gate systems**

Type	PSENSlock	PSENsgate
<b>Application on guards</b>		
Covers	◆	
Flaps	◆	
Hinged safety gates	◆	◆
Sliding safety gates	◆	
<b>Operating principle</b>	<ul style="list-style-type: none"> <li>▶ Non-contact</li> <li>▶ Coded</li> <li>▶ Transponder technology</li> </ul>	<ul style="list-style-type: none"> <li>▶ Mechanical</li> <li>▶ Coded</li> <li>▶ Transponder technology</li> </ul>
<b>Manipulation protection</b>	Very high <sup>1)</sup>	Very high <sup>1)</sup>
<b>Position monitoring</b>	PL e of EN ISO 13849-1	PL e of EN ISO 13849-1
<b>Guard locking device</b>	Process guard locking (magnetic interlock)	Safe guard locking up to <ul style="list-style-type: none"> <li>▶ PL e of EN ISO 13849-1</li> <li>▶ SIL CL 3 of EN/IEC 62061</li> </ul>
<b>Auxiliary/escape release</b>	No	Integrated
<b>Emergency stop pushbutton</b>	No	Integrated
<b>Illuminated button for request and reset</b>	No	2 or 2 + 2 additional pushbuttons
<b>Additional functions</b>	<ul style="list-style-type: none"> <li>▶ Series connection possible with PSENNini, PSENcode, PSENSlock, PSENsgate</li> <li>▶ Optional closing lock</li> </ul>	<ul style="list-style-type: none"> <li>▶ Series connection possible with PSENNini, PSENcode, PSENSlock, PSENsgate</li> <li>▶ Additional control elements (LED)</li> <li>▶ Broken pin and broken bolt are detected</li> <li>▶ Closing lock (padlock on the bolt)</li> <li>▶ Enabling switch can be connected</li> </ul>

<sup>1)</sup> When unique, fully coded version is used

Keep up-to-date on Secure safety gate systems:

 Webcode 5192

Online information at [www.pilz.com](http://www.pilz.com)

## ▶ Safety gate system PSENSlock

The safety gate system PSENSlock offers secure safety gate monitoring based on the non-contact, coded safety switch with electromagnetic process guarding of 500 N or 1000 N (BG GS-ET 19).



PSEN sl-0.5p

PSEN sl-1.0p ... VA

### Stringent protection of man and machine

PSENSlock is a safe alternative to existing mechanical technology for safety gate monitoring. Highest possible manipulation protection and low wear and tear ensure a long service life and protect your investment. Combined with Pilz control technology, you receive a safe, complete solution for guard monitoring.

Whether separately or in series, PSENSlock is configured for the highest categories in safety gate monitoring.

### Save time and costs during commissioning

Thanks to its different assembly directions, PSENSlock can be installed and commissioned quickly and easily. It is optimized for mounting on the popular 45 mm profiles.

With the free moving anchor plate (free moving actuator), even gates requiring high tolerances can be monitored and locked.

### Type code for PSENSlock

#### PSEN sl-1.0fm p 2.2

Product area Pilz SENSors	Magnetic force	Actuator	Connection	Coding	Material
Product range sl – PSENSlock	0.5 500 N 1.0 1000 N	fm free moving	p Connector, M12, 8-pin (series connection integrated in sensor) n Male connector, M12, 5-pin	1.1 Coded 2.1 Fully coded 2.2 Unique, fully coded	VA With stainless steel elements - Base plate - Connector
Operation					
<ul style="list-style-type: none"> <li>▶ Non-contact, coded</li> <li>▶ Transponder (RFID)</li> <li>▶ With safe semiconductor outputs</li> </ul>					

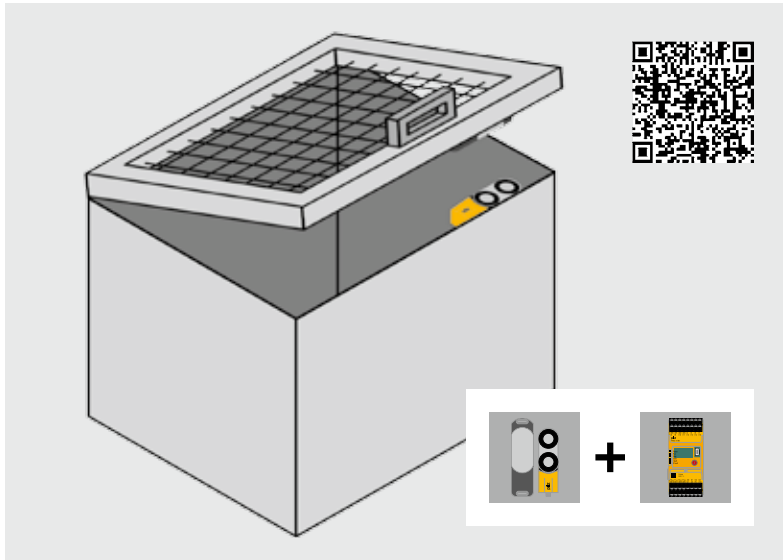

**Your benefits at a glance**

- ▶ Secure safety gate monitoring for the highest safety requirements
- ▶ High availability for your plant:
  - Highest level of manipulation protection (coding)
  - Process protection via magnetic guard locking
- ▶ Rapid commissioning:
  - Four assembly directions
  - Tolerant to gate misalignment
  - Flexible connection via connector
- ▶ User-friendly diagnostics via double-sided LED display
- ▶ Save power, as the magnet on PSENSlock is optimized for energy efficiency

Components for your safe solution	Order number
Sensor: PSEN sl-1.0p 2.2/PSEN sl-1.0	570602
Connection: PSEN cable, M12, 8-pin, 5 m	540320
Evaluation device: PNOZ m B0	772100
- Spring loaded terminals (1 set)	751008

The optimum solution: guard locking on the flap using the safety gate system PSENSlock, evaluated using the configurable control system PNOZmulti 2.



PSENSlock with free moving anchor plate (free moving actuator)



Keep up-to-date on the safety gate system PSENSlock:

 Webcode 5193

Online information at [www.pilz.com](http://www.pilz.com)



## ▶ Selection guide – PSENslock



### Safety gate system PSENslock

#### Common features

- ▶ Safety gate systems for monitoring the position of movable guards in accordance with EN 60947-5-3
- ▶ Suitable for applications up to PL e of EN ISO 13849-1, SIL CL 3 of EN/IEC 62061 with magnetic guard locking for process protection tasks
- ▶ Series connection up to PL e of EN ISO 13849-1:
  - PSEnini, PSEncode, PSENslock with 5-pin connection for decentralized module PDP67 F8 DI ION
  - PSENslock and Pilz sensor technology with 8-pin connection for passive junction PDP67 F 4 code or PSEN Y junction (cable separator)
- ▶ Electrical data:
  - Supply voltage: 24 VDC
  - Voltage tolerance: -15 ... +10 %
  - Outputs: 2 safety outputs and 1 signal output
- ▶ Mechanical data:
  - Vertical and lateral offset: +/-3 / +/-5 mm
  - Protection type: IP67



PSEN sl-0.5



PSEN sl-0.5 ... fm



PSEN sl-1.0p 1.1 VA/  
PSEN sl-1.0

Type (switch/actuator)	Holding force
PSEN sl-0.5n 1.1/PSEN sl-0.5	500 N
PSEN sl-0.5n 1.1/PSEN sl-0.5fm <sup>3)</sup>	500 N
PSEN sl-0.5n 2.1/PSEN sl-0.5	500 N
PSEN sl-0.5n 2.1/PSEN sl-0.5fm <sup>3)</sup>	500 N
PSEN sl-0.5n 2.2/PSEN sl-0.5	500 N
PSEN sl-0.5n 2.2/PSEN sl-0.5fm <sup>3)</sup>	500 N
PSEN sl-1.0n 1.1/PSEN sl-1.0	1000 N
PSEN sl-1.0n 1.1/PSEN sl-1.0fm <sup>3)</sup>	1000 N
PSEN sl-1.0n 2.1/PSEN sl-1.0	1000 N
PSEN sl-1.0n 2.1/PSEN sl-1.0fm <sup>3)</sup>	1000 N
PSEN sl-1.0n 2.2/PSEN sl-1.0	1000 N
PSEN sl-1.0n 2.2/PSEN sl-1.0fm <sup>3)</sup>	1000 N
PSEN sl-0.5p 1.1/PSEN sl-0.5	500 N
PSEN sl-0.5p 1.1/PSEN sl-0.5fm <sup>3)</sup>	500 N
PSEN sl-0.5p 2.1/PSEN sl-0.5	500 N
PSEN sl-0.5p 2.1/PSEN sl-0.5fm <sup>3)</sup>	500 N
PSEN sl-0.5p 2.2/PSEN sl-0.5	500 N
PSEN sl-0.5p 2.2/PSEN sl-0.5fm <sup>3)</sup>	500 N
PSEN sl-1.0p 1.1/PSEN sl-1.0	1000 N
PSEN sl-1.0p 1.1/PSEN sl-1.0fm <sup>3)</sup>	1000 N
PSEN sl-1.0p 2.1/PSEN sl-1.0	1000 N
PSEN sl-1.0p 2.1/PSEN sl-1.0fm <sup>3)</sup>	1000 N
PSEN sl-1.0p 2.2/PSEN sl-1.0	1000 N
PSEN sl-1.0p 2.2/PSEN sl-1.0fm <sup>3)</sup>	1000 N
PSEN sl-1.0p 1.1 VA/PSEN sl-1.0	1000 N

Type of coding	Power consumption <sup>1)</sup>	Dimensions (H x W x D) in mm		Connection type (connector)	Order number (Unit) <sup>2)</sup>
		Safety guard locking device	Actuator		
Coded <sup>4)</sup>	4.8 W	122 x 45 x 44	138 x 52 x 23	M12, 5-pin	570503
Coded <sup>4)</sup>	4.8 W	122 x 45 x 44	138 x 52 x 23	M12, 5-pin	570563
Fully coded <sup>5)</sup>	4.8 W	122 x 45 x 44	138 x 52 x 23	M12, 5-pin	570504
Fully coded <sup>5)</sup>	4.8 W	122 x 45 x 44	138 x 52 x 23	M12, 5-pin	570564
Unique, fully coded <sup>6)</sup>	4.8 W	122 x 45 x 44	138 x 52 x 23	M12, 5-pin	570505
Unique, fully coded <sup>6)</sup>	4.8 W	122 x 45 x 44	138 x 52 x 23	M12, 5-pin	570565
Coded <sup>4)</sup>	7.2 W	172 x 45 x 44	188 x 52 x 23	M12, 5-pin	570603
Coded <sup>4)</sup>	7.2 W	172 x 45 x 44	188 x 52 x 23	M12, 5-pin	570663
Fully coded <sup>5)</sup>	7.2 W	172 x 45 x 44	188 x 52 x 23	M12, 5-pin	570604
Fully coded <sup>5)</sup>	7.2 W	172 x 45 x 44	188 x 52 x 23	M12, 5-pin	570664
Unique, fully coded <sup>6)</sup>	7.2 W	172 x 45 x 44	188 x 52 x 23	M12, 5-pin	570605
Unique, fully coded <sup>6)</sup>	7.2 W	172 x 45 x 44	188 x 52 x 23	M12, 5-pin	570665
Coded <sup>4)</sup>	4.8 W	122 x 45 x 44	138 x 52 x 23	M12, 8-pin	570500
Coded <sup>4)</sup>	4.8 W	122 x 45 x 44	138 x 52 x 23	M12, 8-pin	570560
Fully coded <sup>5)</sup>	4.8 W	122 x 45 x 44	138 x 52 x 23	M12, 8-pin	570501
Fully coded <sup>5)</sup>	4.8 W	122 x 45 x 44	138 x 52 x 23	M12, 8-pin	570561
Unique, fully coded <sup>6)</sup>	4.8 W	122 x 45 x 44	138 x 52 x 23	M12, 8-pin	570502
Unique, fully coded <sup>6)</sup>	4.8 W	122 x 45 x 44	138 x 52 x 23	M12, 8-pin	570562
Coded <sup>4)</sup>	7.2 W	172 x 45 x 44	188 x 52 x 23	M12, 8-pin	570600
Coded <sup>4)</sup>	7.2 W	172 x 45 x 44	188 x 52 x 23	M12, 8-pin	570660
Fully coded <sup>5)</sup>	7.2 W	172 x 45 x 44	188 x 52 x 23	M12, 8-pin	570601
Fully coded <sup>5)</sup>	7.2 W	172 x 45 x 44	188 x 52 x 23	M12, 8-pin	570661
Unique, fully coded <sup>6)</sup>	7.2 W	172 x 45 x 44	188 x 52 x 23	M12, 8-pin	570602
Unique, fully coded <sup>6)</sup>	7.2 W	172 x 45 x 44	188 x 52 x 23	M12, 8-pin	570662
Coded <sup>4)</sup>	7.2 W	172 x 45 x 44	188 x 52 x 23	M12, 8-pin	570630

<sup>1)</sup> Gate locked <sup>2)</sup> Unit comprising switch and actuator <sup>3)</sup> Free moving

<sup>4)</sup> Switch accepts any PSENSlock actuator

<sup>5)</sup> Switch accepts only one PSENSlock actuator, teach-in up to 8 times

<sup>6)</sup> Switch accepts only one PSENSlock actuator, no teach-in facility



Cable and other accessories:

From page 94

Technical documentation on the safety gate system PSENSlock:

Webcode 5193

Online information at [www.pilz.com](http://www.pilz.com)

## ► Safety gate system PSEnsgate

PSEnsgate offers secure safety gate monitoring, protecting personnel and plant to the highest category PL e in a single system.



PSEN sg2c-3LPE

PSEN sg2c-5LPLLE

### Save time and components

You can benefit from a high savings potential: use just one turnkey system and all your safety functions and control elements are integrated.

A number of new system types are available to select, with optional integratable control and operator elements such as pushbuttons, key switches, illuminated buttons, section stop, emergency stop or escape release.

### Economical solution

When combined with safe control technology from Pilz, what you get is a complete safety gate monitoring solution that's safe and economical. It is also easy to connect in series with many other sensors PSEnini, PSEncode and PSEnlock. The robust design is another convincing feature of the PSEnsgate.

### Type code PSEnsgate

PSEN sg2c-5LPKLE-M12/5

Product area Pilz SENSors	Generation	Connection via	Design/elements	Operator elements/ emergency stop <sup>1)</sup>	Connection type <sup>2)</sup>
<b>Product range</b> sg – PSEnsgate  <b>Operation</b> ▶ Mechanical, coded ▶ Transponder (RFID) ▶ With safe guard locking and safety gate monitoring	1 2	c Spring-loaded terminal, plug in	3 Short design, 3 elements 5 Long design, 5 elements	– Not present P Pushbutton L Illuminated pushbutton K Key switch B Key button S Section stop C Blind cover E E-STOP	– Not present M12/5 Male connector, M12, 5-pin

<sup>1)</sup> Sequence: Key assignment from bottom to top

<sup>2)</sup> Connection only for large design

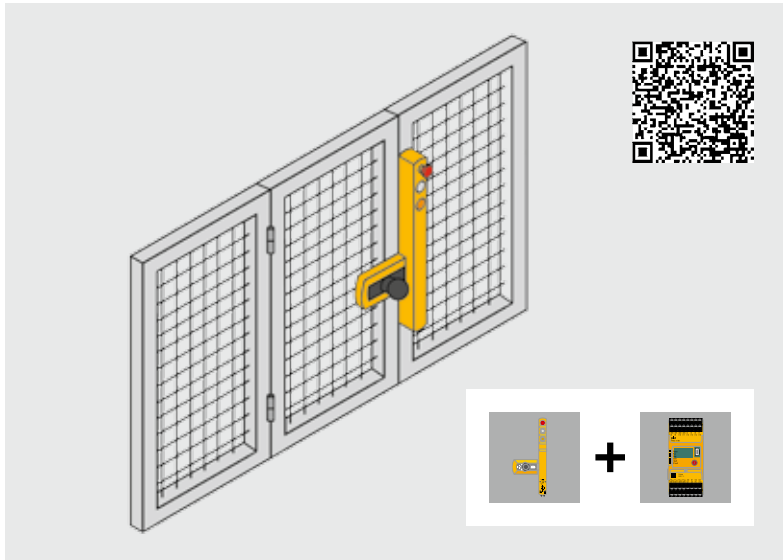

**Your benefits at a glance**

- ▶ Greater flexibility: large selection of different control and operator elements, e.g. key switches, emergency stops, plus the ability to connect enabling switches
- ▶ Maximum safety: just one switch per safety gate for personal and plant protection up to PL e
- ▶ Engineering and costs are minimized: one product rather than several individual components
- ▶ Time saving: reduced installation and wiring effort thanks to a turnkey system with integratable control elements and optional emergency stop
- ▶ Simple assembly: for right and left-hinged gates
- ▶ For universal use: suitable for all 45 mm profiles
- ▶ Energy efficient: reduced current consumption (gate lock max. 2 W)

Components for your safe solution	Order number
Sensor: PSEN sg2c-3LPE	570 800
Connection: Cable, depending on function, e.g. 16 x 0.25 mm <sup>2</sup>	-
Evaluation device: PNOZ m B0	772 100
- Spring loaded terminals (1 set)	751 008

The optimum solution: monitoring a safety gate using the safety gate system PSENsgate and the configurable control system PNOZmulti 2.



Keep up-to-date on the safety gate system PSENsgate:

 Webcode 6474

Online information at [www.pilz.com](http://www.pilz.com)

## ▶ Selection guide – PSENsgate



### Safety gate system PSENsgate

#### Common features

- ▶ Safety gate systems for monitoring the position of movable guards in accordance with EN 60947-5-3
- ▶ Suitable for applications up to PL e of EN ISO 13849-1, SIL CL 3 of EN/IEC 62061
- ▶ Series connection in combination with PSENsgate, PSENini, PSENcode, PSENSlock up to PL e of EN ISO 13849-1, SIL CL 3 of EN/IEC 62061:
  - With 8-pin connector via Y junction (cable separator) or PDP67 F 4 code
- ▶ Electrical data:
  - Supply voltage: 24 VDC
  - Outputs: 2 (semiconductor, each max. 500 mA)
  - Signal output: 500 mA
  - "Safe range" input (solenoid pin): 1.5 A, 150 ms
  - Power consumption depends on configuration (gate locked): max. 2 W
  - Voltage tolerance: -15/+10 %
- ▶ Mechanical data:
  - Vertical and lateral offset: +/-5 / +/-5 mm
  - Holding force, swing gate: 2000 N
  - Connection type: Plug-in spring-loaded terminals
  - Protection type: IP65/54
- ▶ Type of coding:
  - Coded
  - Unique, fully coded (Version 2.2)
- ▶ PSENsgate must be used in conjunction with the auxiliary release. The escape release is optional (see Accessories, page 111)



PSEN sg2c-3LPE



PSEN sg2c-5LPLLE

Type	No. of pushbuttons Emergency stop
▶ Short unit type	
PSEN sg2c-3LPE	1
PSEN sg2c-3LBE	1
PSEN sg2c-3LPS	-
PSEN sg2c-3LBS	-
PSEN sg2c-3LPC	-
PSEN sg2c-3LBC	-
PSEN sg2c-3LPE 2.2	1
▶ Long unit type	
PSEN sg2c-5LPLLE	1
PSEN sg2c-5LBLLLE	1
PSEN sg2c-5LPLLS	-
PSEN sg2c-5LBLLS	-
PSEN sg2c-5LPLLC	-
PSEN sg2c-5LBLLC	-
PSEN sg2c-5LPLLE 2.2	1
▶ Long unit type: Connection type M12, 5-pin	
PSEN sg2c-5LPKLE-M12/5	1
PSEN sg2c-5LBKLE-M12/5	1
PSEN sg2c-5LPKLS-M12/5	-
PSEN sg2c-5LBKLS-M12/5	-
PSEN sg2c-5LPKLC-M12/5	-
PSEN sg2c-5LBKLC-M12/5	-
PSEN sg2c-5LPKLE-M12/5 2.2	1

				Dimensions (H x W x D) in mm	Type of coding	Order number
Section stop	Pushbutton	Key button	Key switch			
-	2	-	-	445 x 200 x 105	Coded	570800
-	1	1	-	445 x 200 x 105	Coded	570802
1	2	-	-	445 x 200 x 105	Coded	570804
1	1	1	-	445 x 200 x 105	Coded	570806
-	2	-	-	445 x 200 x 105	Coded	570808
-	1	1	-	445 x 200 x 105	Coded	570810
-	2	-	-	445 x 200 x 105	Unique, fully coded	570880
-	4	-	-	546 x 200 x 105	Coded	570812
-	3	1	-	546 x 200 x 105	Coded	570814
1	4	-	-	546 x 200 x 105	Coded	570816
1	3	1	-	546 x 200 x 105	Coded	570818
-	4	-	-	546 x 200 x 105	Coded	570820
-	3	1	-	546 x 200 x 105	Coded	570822
-	4	-	-	546 x 200 x 105	Unique, fully coded	570882
-	3	-	1	558.5 x 200 x 105	Coded	570824
-	2	1	1	558.5 x 200 x 105	Coded	570826
1	3	-	1	558.5 x 200 x 105	Coded	570828
1	2	1	1	558.5 x 200 x 105	Coded	570830
-	3	-	1	558.5 x 200 x 105	Coded	570832
-	2	1	1	558.5 x 200 x 105	Coded	570834
-	3	-	1	558.5 x 200 x 105	Unique, fully coded	570884



Cable and other accessories:

 From page 94

Technical documentation on the safety gate system PSENsgate:

 Webcode 6474

Online information at [www.pilz.com](http://www.pilz.com)



## ▶ Light beam devices

When the production process requires active intervention, light beam devices from the product range PSENopt provide optimum protection for plant and machinery. PSENopt provides finger, hand and body protection in accordance with EN/IEC 61496-1/-2, depending on the requirement. A comprehensive range of accessories and light beam devices with advanced functionalities such as muting, blanking or cascading support flexible application on any machine.



### For safe access to the production process

PSENopt offers greater productivity, while safeguarding access to the work process. Save costs:

- ▶ PSENopt devices have a compact design and therefore save space
- ▶ They can quickly be incorporated, operated and maintained on your plant
- ▶ Protected fields and detection capability can be set up to be process-oriented

### PSENopt Advanced – for every discipline

The light beam devices PSENopt Advanced enable maximum flexibility thanks to their multifunctionality: depending on the requirement, either muting or blanking is implemented, with or without cascading, using the same light beam device. Their full functionality can be used in conjunction with the configurable control system PNOZmulti.

### PSENopt – With semiconductor outputs

PSENopt light beam devices, curtains and grids with semiconductor outputs are suitable for all Type 2 and 4 applications in accordance with EN/IEC 61496-1/-2. Read more on page 54.



### Simple commissioning

As single beams can be shown in the software PSENopt Configurator, it is much easier to align and monitor the light beam devices; reaction times can be reduced to a minimum through rapid diagnostics.

**Select the appropriate compliant PSENopt**

Carry out a safety assessment and then assess the risk in accordance with EN/IEC 61496-1/-2. You can then use this information to work out the appropriate light grid resolution for your application, in accordance with EN ISO 13855.

Select the electroresponsive protective device that best meets your needs. This will mean greater safety for finger, hand and body, compatible with a wide range of applications.

**ESPE inspection**

With its independent inspection body (accredited by the German Accreditation Body DAkkS), Pilz is your partner for the internationally valid safety inspection of your electroresponsive protective equipment.



**For every application, the right optical safety sensor PSENopt**

Type	PSENopt		PSENopt Advanced	
Resolution	Finger, hand, body protection as well as access protection		Finger and hand protection	
Approved in accordance with EN/IEC 61496-1/-2	Type 2	Type 4	Type 2	Type 4
Can be used in applications in accordance with				
EN ISO 13849-1	PL d	PL e	PL d	PL e
EN/IEC 62061	SIL CL 2	SIL CL 3	SIL CL 2	SIL CL 3
Functions/features	Feedback loop monitoring, reset, acknowledgement, diagnostics		Feedback loop monitoring, reset, acknowledgement, diagnostics and muting, blanking, cascading	

Resolution/No. of beams	Finger protection (14 mm)	Hand protection (30 mm)	Body protection (2-4 beams)
Height of protected field			
Standard	150 ... 1800 mm	150 ... 1800 mm	500 ... 1200 mm
Advanced	300 ... 1800 mm	300 ... 1800 mm	-
Operating range	0.2 ... 7 m	0.2 ... 20 m	0.5 ... 50 m
Light grid reaction time	11 ... 68 ms	9 ... 43 ms	14 ms

Keep up-to-date on light beam devices PSENopt:

 Webcode 5196

Online information at [www.pilz.com](http://www.pilz.com)

## ▶ Light beam devices PSENopt

Thanks to their compact dimensions, simple installation technology and optimum performance, PSENopt are an ideal solution when high productivity is required along with safe access to the work process, during insertion work, for example.



PSEN op4F.../1



PSEN op4S

As safeguards on plant/machinery access points or danger zones, light beam devices PSENopt provide finger, hand or body protection in accordance with EN/IEC 61496-1/-2.

The wide range of accessories opens up every area of application: light beam devices achieve protection type IP6K9K in protective housings and are therefore suitable for humid environments where there are high demands on hygiene. The mirrors enable the light grid beams to be easily deflected, securing a larger protected field without using additional light grids. Thanks to post protectors, the light grids are protected against shock, collision or vibration, even in rugged industrial environments.

### Type code for PSENopt

#### PSEN op4F-A-14-180/1

Product area Pilz SENSors	Approval	Resolution	Functions	Resolution/ No. of beams	Feature/ Height of protected field	Generation
<b>Product range op – PSENopt</b> <b>Operation</b> ▶ Non-contact, optical, 2D (area monitoring) ▶ With safe semiconductor outputs	2 Type 2 4 Type 4  Approved in accordance with EN/IEC 61496-1/-2	S Single-beam safety light beam device B Body protection (light grid) H Hand protection (light grid) <b>F Finger protection (light grid)</b>	<b>A Advanced (muting/blanking/cascading)</b> s Standard <sup>1)</sup> S Linear version L L-Version T T-Version	1 1 beam 2 2 beams 3 3 beams 4 4 beams <b>14 14 mm</b> 30 30 mm	1 Infrared 2 Laser  015 150 mm 030 300 mm 045 450 mm 050 500 mm 060 600 mm 075 750 mm 080 800 mm 090 900 mm 105 1050 mm 120 1200 mm 135 1350 mm 150 1500 mm 165 1650 mm <b>180 1800 mm</b>	<b>/1 New generation PSENopt</b>

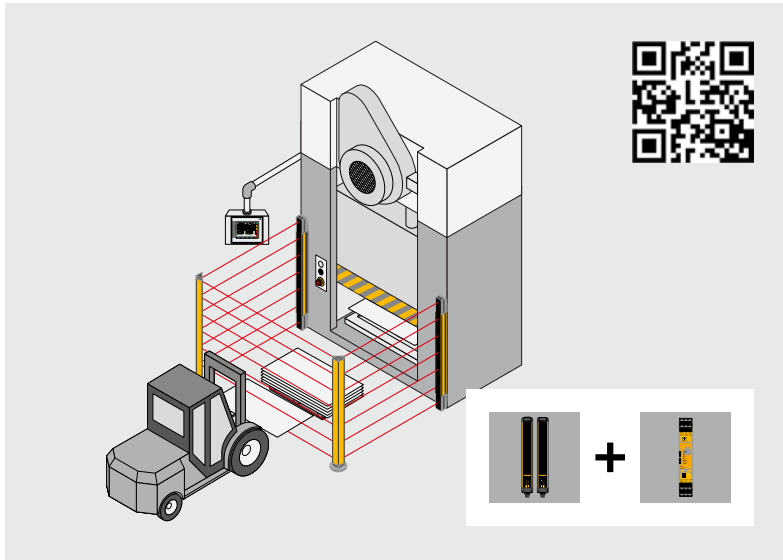

**Your benefits at a glance**

- ▶ Economical:
  - Protected fields and detection capability can be set up to be process-oriented
  - Cost savings with PSENopt integration, operation and maintenance
- ▶ One-stop shop – extensive portfolio with test rods, alignment guide and muting lamps is ideal for combination with safe control technology
- ▶ Higher productivity due to reduced access times
- ▶ Rapid assembly, installation and commissioning
- ▶ Simple maintenance thanks to built-in diagnostic function via LED

Components for your safe solution	Order number
Sensor: PSEN op4H-s-30-090/1	630 765
Connection:	
▶ PSEN op cable, shielded, straight, M12, 4-pin, 5 m	630 304
▶ PSEN op cable, shielded, straight, M12, 8-pin, 5 m	630 314
Evaluation device:	
▶ PNOZ s3 (for one light grid)	751 103
▶ PNOZ mm0p (for multiple light grids)	772 000
- Spring-loaded terminals (1 set)	751 008

The optimum solution: monitoring the infeed area on a press using the light grid PSENopt and safety relay PNOZsigma.

New accessories: deviating mirrors, post protector, front protection, protective housing

 From page 112



Cable and other accessories:

 From page 104

Keep up-to-date on light beam devices PSENopt:

 Webcode 5197

Online information at [www.pilz.com](http://www.pilz.com)

## ► Light beam devices PSENopt Advanced

The multifunctional light beam devices PSENopt Advanced are used for the advanced functions muting, blanking and/or cascading. Configuration is intuitive via the software PSENopt Configurator. Reaction times can be reduced to a minimum through rapid diagnostics.



PSENopt op2H-A...

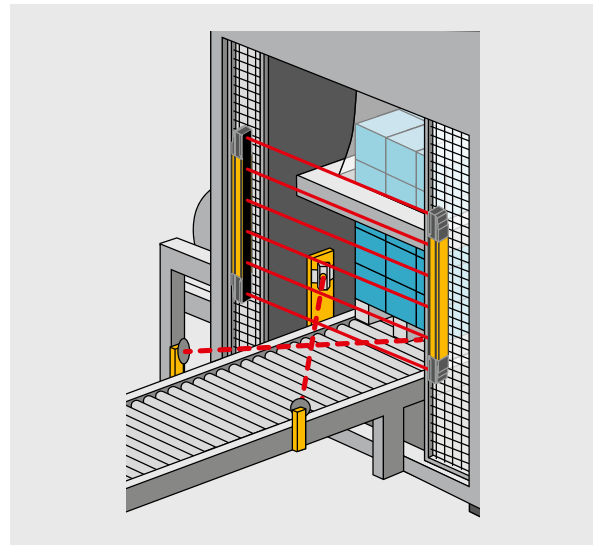

Muting with crossed muting sensors.

### Rapid commissioning

Light beam devices PSENopt Advanced are easy to commission using the software PSENopt Configurator. You can also take advantage of short reaction times thanks to rapid diagnostics.

### Muting to distinguish between a person and material

PSENopt devices with muting function are suitable for transporting material into and out of a danger zone, when loading or unloading pallets for example.



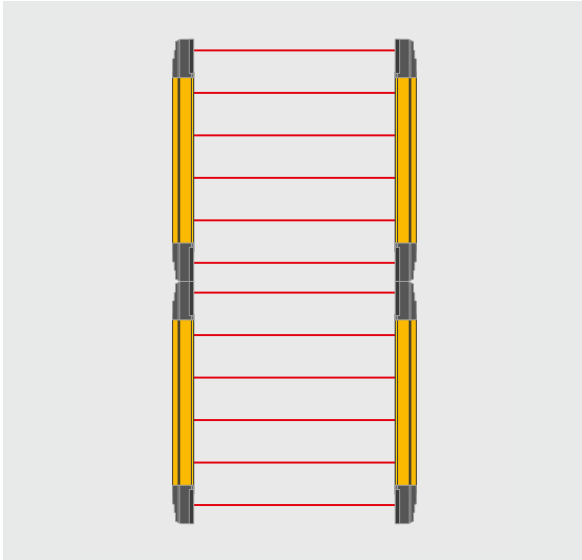

Continuous single beams during cascading, without “dead zones”, increase safety.

**Your benefits at a glance**

- ▶ Simple operation and commissioning with the new software PSENopt Configurator
- ▶ Short reaction times thanks to rapid diagnosis of fault states
- ▶ High flexibility:
  - Three functionalities in one light grid: muting, blanking, cascading
  - Flexible installation thanks to coding
  - Higher level of safety, as there are no “dead zones”

**Cascading function without “dead zones” for effective protection against encroachment into and behind the protected area**

Adjacent protected fields can easily be safeguarded using the cascading function. Just connect master and slave quickly and simply using a convenient plug-in connector; also combines finger and hand protection.

**Blanking for a flexible, uninterrupted production process**

You can use the blanking function to blank out a defined area of the light grid. The safety function will not be triggered when the material to be processed passes through. Blanking can be implemented in two different ways: fixed blanking and floating blanking.

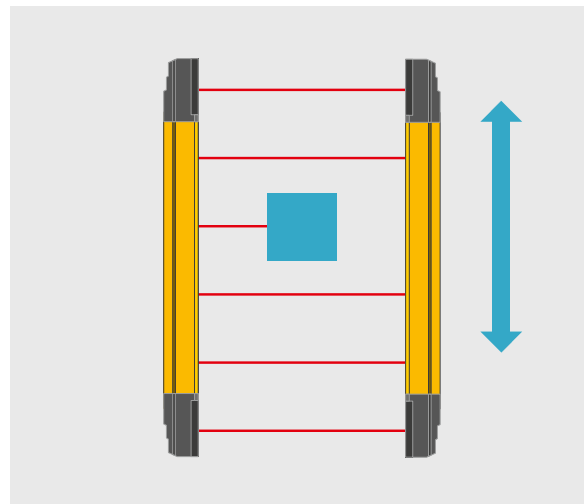

Floating blanking: two beams are blanked out. Any object that interrupts more than two beams will be detected.

New accessories: deviating mirrors, post protector, front protection, protective housing

 From page 112

Cable and other accessories:

 From page 104

Keep up-to-date on light beam devices PSENopt Advanced:

 Webcode 5197

Online information at [www.pilz.com](http://www.pilz.com)



## ▶ Selection guide – PSENopt

### Single-beam safety light beam devices PSEN op2S/4S

#### Common features

- ▶ PL e/SIL CL 3 in conjunction with
  - Safety relay PNOZ e7p
  - Configurable control systems PNOZmulti: PNOZ m0p, PNOZ m1p, PNOZ m2p
  - Programmable control system PSS: PSS DI20 T
- ▶ Supply voltage: 20 ... 30 VDC
- ▶ Design: M18



PSEN op4S-1-2

#### Type

PSEN op2S-1-1
PSEN op4S-1-1
PSEN op4S-1-2

### Body protection: Type 2 – Light grid PSEN op2B

#### Common features

- ▶ Compliant and approved in accordance with:
  - EN/IEC 61508
  - EN/IEC 61496-1/-2
- ▶ For use in applications up to:
  - PL d in accordance with EN ISO 13849-1
  - SIL CL 2 of EN/IEC 62061
- ▶ Function selection:
  - Manual/automatic restart
  - Muting (total/partial) via DIP switch
  - Override function
- ▶ Semiconductor outputs
- ▶ Supply voltage: 24 VDC
- ▶ Connection:
  - Receiver Rx: 1 x connector, M12, 8-pin; 1 x connector, M12, 5-pin
  - Transmitter Tx: 1 x connector, M12, 5-pin; 1 x connector, M12, 4-pin
- ▶ Dimensions: 35 x 41.2 mm

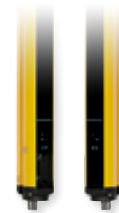

PSEN op2B-3-080/1

#### Type

PSEN op2B-2-050/1
PSEN op2B-3-080/1
PSEN op2B-4-090/1
PSEN op2B-4-120/1

### Body protection: Type 4 – Light grid PSEN op4B

#### Common features

- ▶ Compliant and approved in accordance with:
  - EN/IEC 61508
  - EN/IEC 61496-1/-2: Type 4
- ▶ For use in applications up to:
  - PL e of EN ISO 13849-1
  - SIL CL 3 of EN/IEC 62061
- ▶ Function selection:
  - Manual/automatic restart
  - Muting (total/partial) via DIP switch
  - Override function
- ▶ Semiconductor outputs
- ▶ Supply voltage: 24 VDC
- ▶ Connection:
  - Receiver Rx: 1 x connector, M12, 8-pin; 1 x connector, M12, 4-pin
  - Transmitter Tx: 1 x connector, M12, 5-pin; 1 x connector, M12, 4-pin
- ▶ Dimensions: 35 x 41.2 mm
- ▶ Sets contain light grids with 050/080 length, Muting arm in L- / T-configuration plus bracket
- ▶ Benefits of the set:
  - Pre-configured muting sensors
  - Simple connection

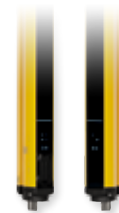

PSEN op4B-2-050/1



PSEN op4B-L-050/1

#### Type

▶ Body protection, muting
PSEN op4B-2-050/1
PSEN op4B-3-080/1
PSEN op4B-4-090/1
PSEN op4B-4-120/1
▶ Sets comprising light grid, muting
PSEN op4B-L-050/1
PSEN op4B-L-080/1
PSEN op4B-T-050/1
PSEN op4B-T-080/1

Resolution/No. of beams	Approved in accordance with EN/IEC 61496-1/-2	Features	Operating range	Response time	Order number <sup>1)</sup>
Access guarding (1 beam)	Type 2	Infrared	0 ... 8 m	1.0 ms max.	630380
Access guarding (1 beam)	Type 4	Infrared	0 ... 8 m	1.0 ms max.	630381
Access guarding (1 beam)	Type 4	Laser	0 ... 40 m	330 µs max.	630382



Resolution/No. of beams	Height of protected field	Operating range	Response time	Order number <sup>1)</sup>
2 beams	500 mm	0.5 ... 50 m	14 ms	630804
3 beams	800 mm	0.5 ... 50 m	14 ms	630805
4 beams	900 mm	0.5 ... 50 m	14 ms	630806
4 beams	1200 mm	0.5 ... 50 m	14 ms	630807

Resolution/No. of beams	Height of protected field	Operating range	Response time	Order number <sup>1)</sup>
2 beams	500 mm	0.5 ... 50 m	14 ms	630800
3 beams	800 mm	0.5 ... 50 m	14 ms	630801
4 beams	900 mm	0.5 ... 50 m	14 ms	630802
4 beams	1200 mm	0.5 ... 50 m	14 ms	630803
<b>arm and bracket<sup>3)</sup></b>				
2 beams	500 mm	0.5 ... 50 m <sup>2)</sup>	14 ms	630808
3 beams	800 mm	0.5 ... 50 m <sup>2)</sup>	14 ms	630809
2 beams	500 mm	0.5 ... 50 m <sup>2)</sup>	14 ms	630810
3 beams	800 mm	0.5 ... 50 m <sup>2)</sup>	14 ms	630811

New accessories:  
 deviating mirrors,  
 post protector,  
 front protection,  
 protective housing

From page 112

Cable and other accessories:

From page 104

Technical documentation on light beam devices PSENopt:

Webcode 5197

Online information at [www.pilz.com](http://www.pilz.com)

<sup>1)</sup> Order number for transmitter, receiver and mounting bracket respectively (one unit)

<sup>2)</sup> When muting arms are used

<sup>3)</sup> Muting arms can also be ordered separately (see Page 116)

## ▶ Selection guide – PSENopt

### Hand protection: Type 2 – Light grid PSEN op2H

#### Common features

- ▶ Compliant and approved in accordance with:
  - EN/IEC 61508
  - EN/IEC 61496-1/-2
- ▶ For use in applications up to:
  - PL d in accordance with EN ISO 13849-1
  - SIL CL 2 of EN/IEC 62061
- ▶ Automatic restart
- ▶ Semiconductor outputs
- ▶ Supply voltage: 24 VDC
- ▶ Connection:
  - Receiver Rx: Male connector, M12, 5-pin
  - Transmitter Tx: Male connector, M12, 4-pin
- ▶ Dimensions: 32.3 x 36.9 mm



PSEN op2H-s-30-060/1

#### Type

##### ▶ Hand protection, standard

PSEN op2H-s-30-015/1
PSEN op2H-s-30-030/1
PSEN op2H-s-30-045/1
PSEN op2H-s-30-060/1
PSEN op2H-s-30-075/1
PSEN op2H-s-30-090/1
PSEN op2H-s-30-105/1
PSEN op2H-s-30-120/1
PSEN op2H-s-30-135/1
PSEN op2H-s-30-150/1
PSEN op2H-s-30-165/1
PSEN op2H-s-30-180/1

### Hand protection: Type 4 – Light grid PSEN op4H

#### Common features

- ▶ Compliant and approved in accordance with:
  - EN/IEC 61508
  - EN/IEC 61496-1/-2: Type 4
- ▶ For use in applications up to:
  - PL e of EN ISO 13849-1
  - SIL CL 3 of EN/IEC 62061
- ▶ Function selection:
  - Manual/automatic restart
  - Feedback loop monitoring (EDM)
- ▶ Connection:
  - Receiver Rx: Male connector, M12, 8-pin
  - Transmitter Tx: Male connector, M12, 4-pin
- ▶ Safe semiconductor outputs: 2
- ▶ Supply voltage: 24 VDC
- ▶ Dimensions:
  - PSENopt 4H-s-30-xxx/1: 32.3 x 36.9 mm



PSEN op4H-s-30-090/1

#### Type

##### ▶ Hand protection, standard

PSEN op4H-s-30-015/1
PSEN op4H-s-30-030/1
PSEN op4H-s-30-045/1
PSEN op4H-s-30-060/1
PSEN op4H-s-30-075/1
PSEN op4H-s-30-090/1
PSEN op4H-s-30-105/1
PSEN op4H-s-30-120/1
PSEN op4H-s-30-135/1
PSEN op4H-s-30-150/1
PSEN op4H-s-30-165/1
PSEN op4H-s-30-180/1

Resolution	Height of protected field	Operating range	Response time	Order number <sup>1)</sup>
30 mm	150 mm	0.2 ... 19 m	8 ms	630720
30 mm	300 mm	0.2 ... 19 m	9 ms	630721
30 mm	450 mm	0.2 ... 19 m	11 ms	630722
30 mm	600 mm	0.2 ... 19 m	12 ms	630723
30 mm	750 mm	0.2 ... 19 m	14 ms	630724
30 mm	900 mm	0.2 ... 19 m	15 ms	630725
30 mm	1050 mm	0.2 ... 19 m	17 ms	630726
30 mm	1200 mm	0.2 ... 19 m	18 ms	630727
30 mm	1350 mm	0.2 ... 19 m	20 ms	630728
30 mm	1500 mm	0.2 ... 19 m	21 ms	630729
30 mm	1650 mm	0.2 ... 19 m	23 ms	630730
30 mm	1800 mm	0.2 ... 19 m	24 ms	630731



Resolution	Height of protected field	Operating range	Response time	Order number <sup>1)</sup>
30 mm	150 mm	0.2 ... 19 m	8 ms	630760
30 mm	300 mm	0.2 ... 19 m	9 ms	630761
30 mm	450 mm	0.2 ... 19 m	11 ms	630762
30 mm	600 mm	0.2 ... 19 m	12 ms	630763
30 mm	750 mm	0.2 ... 19 m	14 ms	630764
30 mm	900 mm	0.2 ... 19 m	15 ms	630765
30 mm	1050 mm	0.2 ... 19 m	17 ms	630766
30 mm	1200 mm	0.2 ... 19 m	18 ms	630767
30 mm	1350 mm	0.2 ... 19 m	20 ms	630768
30 mm	1500 mm	0.2 ... 19 m	21 ms	630769
30 mm	1650 mm	0.2 ... 19 m	23 ms	630770
30 mm	1800 mm	0.2 ... 19 m	24 ms	630771

New accessories:  
 deviating mirrors,  
 post protector,  
 front protection,  
 protective housing

From page 112

Cable and other accessories:

From page 104

Technical documentation on light beam devices PSENopt:

Webcode 5197

Online information at [www.pilz.com](http://www.pilz.com)

<sup>1)</sup> Order number for transmitter, receiver and mounting bracket respectively (one unit)

## ▶ Selection guide – PSENopt

### Finger protection: Type 4 – Light grid PSEN op4F

#### Common features

- ▶ Compliant and approved in accordance with:
  - EN/IEC 61508
  - EN/IEC 61496-1/-2: Type 4
- ▶ For use in applications up to:
  - PL e of EN ISO 13849-1
  - SIL CL 3 of EN/IEC 62061
- ▶ Function selection:
  - Via DIP switch, manual/automatic reset
  - Feedback loop monitoring
- ▶ Connection:
  - Receiver Rx: Male connector, M12, 8-pin
  - Transmitter Tx: Male connector, M12, 4-pin
- ▶ Safe semiconductor outputs: 2
- ▶ Supply voltage: 24 VDC
- ▶ Dimensions:
  - PSENopt 4F-s-14-xxx/1: 32.3 x 36.9 mm
  - Other PSENopt 4F: 35 x 40 mm



PSEN op4F-s-14-060/1

#### Type

##### ▶ Finger protection, standard

PSEN op4F-s-14-015/1

PSEN op4F-s-14-030/1

PSEN op4F-s-14-045/1

PSEN op4F-s-14-060/1

PSEN op4F-s-14-075/1

PSEN op4F-s-14-090/1

PSEN op4F-s-14-105/1

PSEN op4F-s-14-120/1

PSEN op4F-s-14-135/1

PSEN op4F-s-14-150/1

PSEN op4F-s-14-165/1

PSEN op4F-s-14-180/1

Resolution	Height of protected field	Operating range	Response time	Order number <sup>1)</sup>
14 mm	150 mm	0.2 ... 6 m	11 ms	630740
14 mm	300 mm	0.2 ... 6 m	15 ms	630741
14 mm	450 mm	0.2 ... 6 m	18 ms	630742
14 mm	600 mm	0.2 ... 6 m	22 ms	630743
14 mm	750 mm	0.2 ... 6 m	25 ms	630744
14 mm	900 mm	0.2 ... 6 m	29 ms	630745
14 mm	1 050 mm	0.2 ... 6 m	33 ms	630746
14 mm	1 200 mm	0.2 ... 6 m	36 ms	630747
14 mm	1 350 mm	0.2 ... 6 m	40 ms	630748
14 mm	1 500 mm	0.2 ... 6 m	43 ms	630749
14 mm	1 650 mm	0.2 ... 6 m	47 ms	630750
14 mm	1 800 mm	0.2 ... 6 m	50 ms	630751

<sup>1)</sup> Order number for transmitter, receiver and mounting bracket respectively (one unit)



New accessories:  
 deviating mirrors,  
 post protector,  
 front protection,  
 protective housing

 From page 112

Cable and other accessories:

 From page 104

Technical documentation on light beam devices PSENopt:

 Webcode 5197

Online information at [www.pilz.com](http://www.pilz.com)



## ▶ Selection guide – PSENopt Advanced

### Hand protection, muting: Type 2 – Light grid PSEN op2H

#### Common features

- ▶ Compliant and approved in accordance with:
  - EN/IEC 61508
  - EN/IEC 61496-1/-2: Type 4
- ▶ For use in applications up to:
  - PL d in accordance with EN ISO 13849-1
  - SIL CL 2 of EN/IEC 62061
- ▶ Function selection:
  - Manual/automatic restart
  - Muting (total/partial) via soft keys
  - Feedback loop monitoring (EDM)
  - Override function
  - Operating range reduction
- ▶ Semiconductor outputs: 2 pieces
- ▶ No dead zones
- ▶ Supply voltage: 24 VDC
- ▶ Connection:
  - Receiver Rx: 1 x connector, M12, 12-pin;
  - 1 x connector, M12, 5-pin
  - Transmitter Tx: 1 x connector, M12, 5-pin
- ▶ Dimensions: 35 x 40.8 mm



PSEN op2H-A-30-...

#### Type

##### ▶ Hand protection, muting

PSEN op2H-A-30-030/1
PSEN op2H-A-30-045/1
PSEN op2H-A-30-060/1
PSEN op2H-A-30-075/1
PSEN op2H-A-30-090/1
PSEN op2H-A-30-105/1
PSEN op2H-A-30-120/1
PSEN op2H-A-30-135/1
PSEN op2H-A-30-150/1
PSEN op2H-A-30-165/1
PSEN op2H-A-30-180/1

### Hand protection, muting, blanking, cascading: Type 4 – Light grid PSEN op4H

#### Common features

- ▶ Compliant and approved in accordance with:
  - EN/IEC 61508
  - EN/IEC 61496-1/-2: Type 4
- ▶ For use in applications up to:
  - PL e of EN ISO 13849-1
  - SIL CL 3 of EN/IEC 62061
- ▶ Function selection:
  - Manual/automatic restart
  - Muting (total/partial) via soft keys/software
  - Fixed/floating blanking via soft keys/software
  - Cascading
  - Feedback loop monitoring (EDM)
  - Beam-coding
  - Override function
  - Operating range reduction
  - Programming software (online/offline) and monitoring
- ▶ Semiconductor outputs: 2 pieces
- ▶ No dead zones
- ▶ Supply voltage: 24 VDC
- ▶ Connection:
  - Receiver Rx: 1 x connector, M12, 12-pin;
  - 1 x connector, M12, 5-pin (for muting only)
  - Transmitter Tx: 1 x connector, M12, 5-pin
- ▶ Dimensions: 35 x 40.8 mm



PSEN op4H-A-30-...

#### Type

##### ▶ Hand protection, muting, blanking,

PSEN op4H-A-30-030/1
PSEN op4H-A-30-045/1
PSEN op4H-A-30-060/1
PSEN op4H-A-30-075/1
PSEN op4H-A-30-090/1
PSEN op4H-A-30-105/1
PSEN op4H-A-30-120/1
PSEN op4H-A-30-135/1
PSEN op4H-A-30-150/1
PSEN op4H-A-30-165/1
PSEN op4H-A-30-180/1

Resolution	Height of protected field	Operating range	Response time	Order number <sup>1)</sup>
30 mm	300 mm	0.2 ... 20 m	13 ms	631 040
30 mm	450 mm	0.2 ... 20 m	14 ms	631 041
30 mm	600 mm	0.2 ... 20 m	15 ms	631 042
30 mm	750 mm	0.2 ... 20 m	16 ms	631 043
30 mm	900 mm	0.2 ... 20 m	17 ms	631 044
30 mm	1 050 mm	0.2 ... 20 m	18 ms	631 045
30 mm	1 200 mm	0.2 ... 20 m	19 ms	631 046
30 mm	1 350 mm	0.2 ... 20 m	19 ms	631 047
30 mm	1 500 mm	0.2 ... 20 m	20 ms	631 048
30 mm	1 650 mm	0.2 ... 20 m	21 ms	631 049
30 mm	1 800 mm	0.2 ... 20 m	22 ms	631 050



Resolution	Height of protected field	Operating range	Response time	Order number <sup>1)</sup>
<b>cascading</b>				
30 mm	300 mm	0.2 ... 20 m	13 ms	631 020
30 mm	450 mm	0.2 ... 20 m	14 ms	631 021
30 mm	600 mm	0.2 ... 20 m	15 ms	631 022
30 mm	750 mm	0.2 ... 20 m	16 ms	631 023
30 mm	900 mm	0.2 ... 20 m	17 ms	631 024
30 mm	1 050 mm	0.2 ... 20 m	18 ms	631 025
30 mm	1 200 mm	0.2 ... 20 m	19 ms	631 026
30 mm	1 350 mm	0.2 ... 20 m	19 ms	631 027
30 mm	1 500 mm	0.2 ... 20 m	20 ms	631 028
30 mm	1 650 mm	0.2 ... 20 m	21 ms	631 029
30 mm	1 800 mm	0.2 ... 20 m	22 ms	631 030

New accessories:  
 deviating mirrors,  
 post protector,  
 front protection,  
 protective housing

From page 112

Cable and other accessories:

From page 104

Technical documentation on light beam devices PSENopt:

Webcode 5197

Online information at [www.pilz.com](http://www.pilz.com)

<sup>1)</sup> Pigtail cables are not supplied with the device

## ▶ Selection guide – PSENopt Advanced

### Finger protection, muting, blanking, cascading: Type 4 – Light grid PSEN op4F

#### Common features

- ▶ Compliant and approved in accordance with:
  - EN/IEC 61508
  - EN/IEC 61496-1/-2: Type 4
- ▶ For use in applications up to:
  - PL e of EN ISO 13849-1
  - SIL CL 3 of EN/IEC 62061
- ▶ Function selection:
  - Manual/automatic restart
  - Muting (total/partial) via soft keys/software
  - Fixed/floating blanking via soft keys/software
  - Cascading
  - Feedback loop monitoring (EDM)
  - Beam-coding
  - Override function
  - Operating range reduction
  - Programming software (online/offline) and monitoring
- ▶ Semiconductor outputs: 2 pieces
- ▶ No dead zones
- ▶ Supply voltage: 24 VDC
- ▶ Connection:
  - Receiver Rx: 1 x connector, M12, 12-pin;
  - 1 x connector, M12, 5-pin (for muting only)
  - Transmitter Tx: 1 x connector, M12, 5-pin
- ▶ Dimensions: 35 x 40.8 mm



PSEN op4F-A-14-...

#### Type

- ▶ Finger protection, muting, blanking,

PSEN op4F-A-14-030/1

PSEN op4F-A-14-045/1

PSEN op4F-A-14-060/1

PSEN op4F-A-14-075/1

PSEN op4F-A-14-090/1

PSEN op4F-A-14-105/1

PSEN op4F-A-14-120/1

PSEN op4F-A-14-135/1

PSEN op4F-A-14-150/1

PSEN op4F-A-14-165/1

PSEN op4F-A-14-180/1

Resolution	Height of protected field	Operating range	Response time	Order number <sup>1)</sup>
<b>cascading</b>				
14 mm	300 mm	0.2 ... 7 m	15 ms	631 000
14 mm	450 mm	0.2 ... 7 m	17 ms	631 001
14 mm	600 mm	0.2 ... 7 m	19 ms	631 002
14 mm	750 mm	0.2 ... 7 m	20 ms	631 003
14 mm	900 mm	0.2 ... 7 m	22 ms	631 004
14 mm	1 050 mm	0.2 ... 7 m	24 ms	631 005
14 mm	1 200 mm	0.2 ... 7 m	26 ms	631 006
14 mm	1 350 mm	0.2 ... 7 m	27 ms	631 007
14 mm	1 500 mm	0.2 ... 7 m	29 ms	631 008
14 mm	1 650 mm	0.2 ... 7 m	31 ms	631 009
14 mm	1 800 mm	0.2 ... 7 m	33 ms	631 010



<sup>1)</sup> Pigtail cables are not supplied with the device

New accessories:  
 deviating mirrors,  
 post protector,  
 front protection,  
 protective housing

 From page 112

Cable and other  
 accessories:

 From page 104

Technical docu-  
 mentation on light  
 beam devices  
 PSENopt:

 Webcode 5197

Online information  
 at [www.pilz.com](http://www.pilz.com)

## ▶ Camera-based protection system PSEnvip for

The camera-based protection system PSEnvip is a mobile protection system. It is used for the safe monitoring of press brakes. When installed on the upper die, the system detects even the smallest foreign body in the protected field between the transmitter and receiver.



Finger protection



Bending angle is recorded



PSEnvip RL D Set

### Innovative optical system for high productivity

An innovative optical system is used: the visible light beams are transmitted to the receiver via a telecentric lens (vision parallel). As a result, PSEnvip provides high availability and therefore better productivity compared to laser-based systems.

### Highly robust thanks to resistant technology

PSEnvip is insensitive to reflections and external/diffused light, as well as vibration and temperature stratification (e.g. due to heated tools). The longer service life of the light source reduces maintenance costs. As the light is safe for eyes, PSEnvip provides a higher level of safety than conventional systems.

### Fast, simple original equipment and tool change

Precision adjustment on original equipment and after tool change can be made quickly and simply thanks to the innovative technology and software. This reduces setup times to a minimum.

In conjunction with descriptive information on the display, it guarantees productive work practices in complete safety. Time savings and intuitive handling make for happy operators.

### Forming technology more efficient than ever

The PSEnvip type with bending angle measurement records relevant control data from the bending process: the plate is detected automatically and the bending angle measured. Consistently high production quality and easy handling bring competitive advantages.

### Type code for PSEnvip

#### PSEnvip RL D M Set

Product area Pilz SENSors	Transmitter/ receiver	Display (receiver)	Version (receiver)	Scope
Product range vip – PSEnvip	T Transmitter RL Receiver, left	D With display	– Base version M With bending angle measurement P Productive version	Set Unit comprising transmitter and receiver
Operation Non-contact, optical, 2D (area monitoring)				

# press brakes

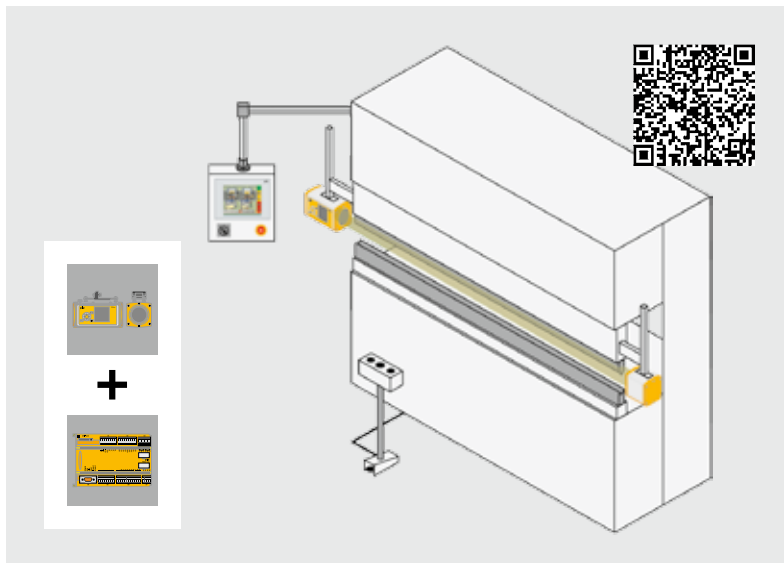

Components for your safe solution	Order number
Sensor: PSEnvip RL D Set	583 000
Connection:	
▶ PSEN op cable, shielded, straight, M12, 4-pin, 5 m	630 304
▶ PSEN op cable, shielded, straight, M12, 8-pin, 5 m	630 314
Evaluation device: PNOZ m2p	773 120
- Spring loaded terminals (1 set)	783 100

Safe and effective press braking with the base version: camera-based protection system PSEnvip and configurable safety system PNOZmulti.

## Your benefits at a glance

- ▶ Highest level of safety for press brakes in accordance with the most current safety standards and EN 12622
- ▶ Highly robust, resistant to vibration
- ▶ Higher level of operator safety:
  - LED light is safe for eyes
  - New, innovative evaluation of protected field
  - Detection zone certified up to 10 m
- ▶ Higher productivity and availability thanks to
  - Innovative optical system
  - Tolerance to vibration, temperature stratification, reflections, external/diffused light
- ▶ User-friendly:
  - Software-supported precision adjustment after tool change
  - User-friendly operation via integrated display

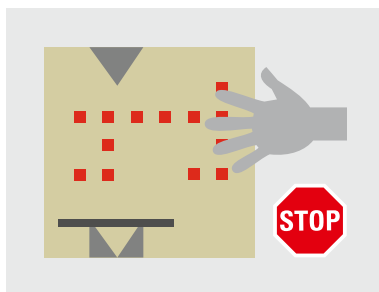

Foreign bodies in the optical field are detected immediately and the press operation is stopped.

## Flexible application with integrated protection against reaching behind the system

The protected field enables flexible application in back gauge or box bending mode. One system protects the danger zone on the press from both front and behind.

Special purpose presses can also be equipped with PSEnvip, as the system is certified for detection zones up to 10 m.

Accessories:

 From page 117

Keep up-to-date on the camera-based protection system PSEnvip:

 Webcode 5569

Online information at [www.pilz.com](http://www.pilz.com)



## ► Productive version PSEnvip plus PSS 4000 FAST

**FAST**



PSEnvip productive version in combination with the automation system PSS 4000.

### Productive and safe

When combined with the Fast Control Unit in the automation system PSS 4000, dynamic muting mode with the productive version of PSEnvip enables a productivity increase of up to 50% compared with the base version.

The control system PSSuniversal PLC performs two central tasks in this process: it monitors dynamic muting and it monitors the speed profile during the braking process. Fast, local muting is enabled by the “intelligence” of the I/O module. This allows even coils and valves to be switched off rapidly. As a result the total reaction time is shortened and the overrun distance of the upper tool is reduced to a minimum. The functions are available as blocks in the software platform PAS4000.

As a result, it's possible to approach the plate for longer at high speed during the bending process. So the time that the upper tool travels at reduced speed is reduced to a minimum.

### Your benefits at a glance

- Increase productivity by up to 50% over the base version thanks to dynamic muting mode
  - Plate position is checked
  - Speed is monitored
  - Approach the plate at high speed for longer
- Flexible adjustment to the respective application thanks to the wide range of I/O modules in the control system PSSuniversal PLC
- Innovative, productive system with compatible hardware and software with TÜV concept approval
- Plus all the benefits of PSEnvip (see page 69)

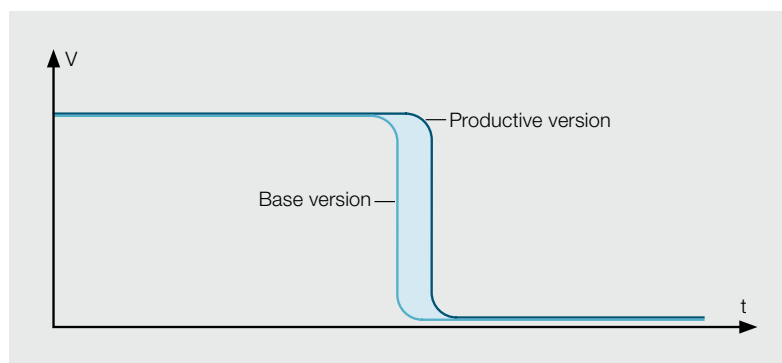

Bending process with productivity benefit.

Selection guide – Camera-based protection system PSEnvip



PSEnvip RL D Set

Type	Design	Transmitter	Receiver	Display type	Order number
PSEnvip RL D Set	Base version set	◆	◆	◆	583000 <sup>1)</sup>
PSEnvip RL D	Base version		◆	◆	583600
PSEnvip RL D M Set	Version with bending angle measurement set	◆	◆	◆	583002 <sup>1)</sup>
PSEnvip RL D M	Version with bending angle measurement		◆	◆	583610
PSEnvip RL D P Set	Productive version set	◆	◆	◆	583007 <sup>1)2)</sup>
PSEnvip RL D P	Productive version		◆	◆	583601 <sup>2)</sup>
PSEnvip T	Transmitter	◆			583900

<sup>1)</sup> PSEnvip (sets) include: transmitter, receiver, adjustment plates, adjustment templates with magnet and a test piece

<sup>2)</sup> In combination with the control system PSSuniversal PLC, PSSu K F FCU Fast Control Unit and 2 counter modules PSSu E F ABS SSI can be used

**Features of bending angle measurement**

- ▶ Distance between workpiece (plate) and receiver: max. 1.5 m
- ▶ Sheet thickness: 2 ... 4 mm
- ▶ Bending angle: 50 ... 160°
- ▶ Temperature range (environment): +10 ... +40 °C

**Common features**

- ▶ Detection zone:
  - Length: 0.1 ... 10 m
  - Height: max. 19 mm
  - Width: 38 mm
- ▶ Reaction time: 4 ms
- ▶ Compliant and approved in accordance with EN 12622
- ▶ For use in applications up to
  - Type 4 in accordance with EN/IEC 61496-1/-2
  - PL e of EN ISO 13849-1
  - SIL CL 3 of EN/IEC 61508



Cable and other accessories:

From page 117

Keep up-to-date on: Camera-based protection system PSEnvip:

Webcode 5569

PSS 4000 FAST Control Unit

Webcode 9270

Control system PSSuniversal PLC

Webcode 5775

Online information at [www.pilz.com](http://www.pilz.com)



## ▶ Safe Camera System SafetyEYE®

SafetyEYE is a “sight-based” safety technology for zone monitoring. It combines intelligent sensor technology with effective control.



PSEN se Starter Set 1

### Three-dimensional monitoring and control

The safe camera system SafetyEYE protects your plant from a bird's eye view, because the sensing device is installed above the zone to be monitored. Where today's applications require a multitude of sensors, a three-dimensional protective cocoon surrounds the danger zone or the object that is to be monitored. This guarantees free access to the work area and means that workstations can be designed with ergonomics in mind.

### Barrier-free protection

The first safe camera system for three-dimensional zone monitoring detects and reports objects that encroach into warning and detection zones.

Various actions can be assigned: for example, hazardous movements may be slowed down or brought to an emergency stop, acoustic or optical warning messages may be triggered or an alarm message issued to safety personnel.

### Maximum productivity, highly versatile

The use of SafetyEYE is indispensable where man and machine work in close co-operation. After all, in a work situation it's important to meet both the production speed as well as the high demands on safety.

### Detection zones set up rapidly at the click of a mouse

Innovative 3D technology and user-friendly software enable even complex applications to be monitored and controlled with one system. Virtual warning and detection zones are set up intuitively using the SafetyEYE Configurator. You define the zones, combine them into groups or switch zone arrangements to suit your needs. This lowers your costs, reduces the number of components to a minimum and cuts expenditure on installation and engineering.



SafetyEYE enables man and machine to work together safely.

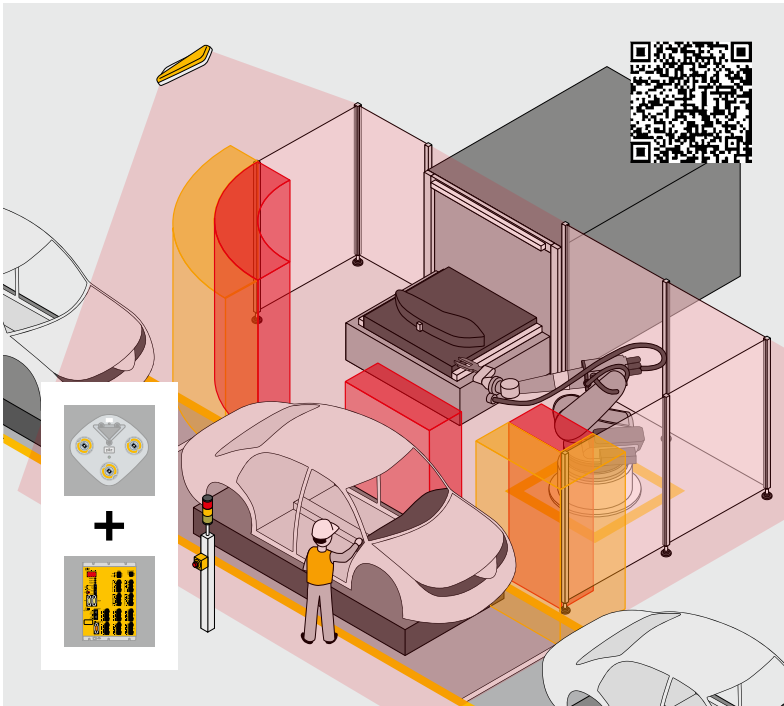

**Your benefits at a glance**

- ▶ High level of safety and manipulation protection
- ▶ Economical solution for three-dimensional monitoring and control
- ▶ Ergonomic workstations for higher productivity
- ▶ Efficient work practices for high cost-effectiveness
- ▶ User-friendly software with the SafetyEYE Configurator

Leading technology: sensor and analysis unit combined with the programmable control system PSS.

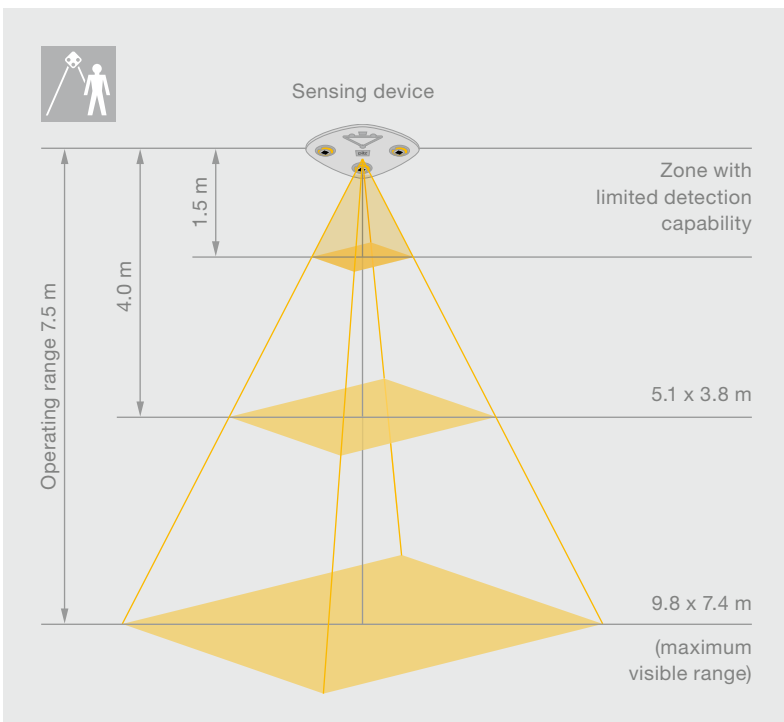

Dimensions of the safely monitored zone

- ▶ Body protection, up to 7.5 m operating range
- ▶ Arm protection, up to 4 m operating range
- ▶ Max. visible range approx. 72 m<sup>2</sup>
- ▶ Lighting from 300 lux required (depending on the background)
- ▶ for applications up to PL d EN ISO 13849-1, SIL 2 (EN IEC 61508), DIN EN 61496
- ▶ Protection types for sensing device: IP65, analysis unit: IP20

Accessories:

Page 118

Keep up-to-date on safe camera systems SafetyEYE:

Webcode 7153

Online information at [www.pilz.com](http://www.pilz.com)

## ▶ Selection guide – SafetyEYE®

### Safe camera systems SafetyEYE – Starter Set



PSEN se Starter Set 1

Type	Features
PSEN se Starter Set 1	<ul style="list-style-type: none"> <li>▶ Body protection, up to 7.5 m operating range</li> <li>▶ Maximum visible range approx. 72 m<sup>2</sup></li> <li>▶ Lighting from 300 lux required, depending on the background</li> <li>▶ Protection types:                             <ul style="list-style-type: none"> <li>- Sensing device IP65</li> <li>- Analysis unit IP20</li> </ul> </li> <li>▶ Designed in accordance with all relevant norms and standards:                             <ul style="list-style-type: none"> <li>- SIL CL 2 of EN/IEC 61508</li> <li>- PL d of EN ISO 13849-1</li> <li>- In accordance with DIN EN 61496-1</li> </ul> </li> <li>▶ Suitable for worldwide use</li> </ul>
PSEN se Starter Set 1 UL	As Starter Set 1 with UL certified components

### Sensing device



PSEN se SU AM3 65

Type	Designation
PSEN se SU AM3 65	Sensing device

### Analysis unit and programmable control system



PSEN se AU AM3



PSS SB 3075-3  
ETH-2 SE

Type	Designation
PSEN se AU AM3	Analysis unit (2nd generation), 482.6 mm/19" module for rack-mounting
PSS 3047-3 ETH-2 SE	Programmable control system with pre-installed user program for SafetyEYE (32 digital inputs, 6 of which are alarm outputs; 12 single-pole outputs, 4 of which are test pulse outputs; 3 dual-pole outputs; Ethernet interfaces)
PSS SB 3075-3 ETH-2 SE	Programmable control system with pre-installed user program for SafetyEYE (48 digital inputs, 6 of which are alarm outputs; 18 single-pole outputs, 4 of which are test pulse outputs; 9 dual-pole outputs; SafetyBUS p and Ethernet interfaces)

Starter Set contains	Order number
<ul style="list-style-type: none"> <li>▶ PSEN se SU AM3 65</li> <li>▶ PSEN se PA 250</li> <li>▶ PSEN se AU AM3</li> <li>▶ PSEN se AU AM2 Rear Mount</li> <li>▶ PSS 3047-3 ETH-2 SE</li> <li>▶ PSS ZKL 3047-3</li> <li>▶ PSEN se TO Body 140</li> <li>▶ PSEN se Cable FO2C 30</li> <li>▶ PSEN se Cable ETH Patch 1 (2 cables)</li> <li>▶ PSEN se Cable ETH Patch 5</li> <li>▶ CFast Card (2 pieces)</li> <li>▶ PIT si3.1 indicator light unit</li> <li>▶ PSEN se SM 6</li> <li>▶ PSEN se SM 10</li> <li>▶ PSEN se RM 6</li> <li>▶ PSEN se RM 10</li> <li>▶ SafetyEYE Assistant and Configurator</li> </ul>	581 300
Components of Starter Set 1 plus PSEN se Cable FO2C 30 UL	581 301



Dimensions (H x W x D) in mm	Protection type <sup>1)</sup>	Ambient temperature <sup>2)</sup>	Supply voltage	Order number
82.0 x 292.0 x 292.0	IP65	0 ... 50 °C		581 130 <sup>3)</sup>

Dimensions (H x W x D) in mm	Protection type <sup>1)</sup>	Ambient temperature <sup>2)</sup>	Supply voltage	Order number
312.0 x 483.0 x 405.0	IP54 <sup>4)</sup> /IP20 <sup>5)</sup>	0 ... 40 °C	110 ... 240 V AC	581 131 <sup>3)</sup>
246.4 x 123.6 x 162.0	IP20	0 ... 60 °C	24 VDC	300 123 <sup>3)</sup>
246.4 x 160.2 x 162.0	IP20	0 ... 60 °C	24 VDC	300 253

Note: This leaflet considers the current development status. Please refer to the Internet for the latest technical details.

<sup>1)</sup> In accordance with EN 60529 <sup>2)</sup> In accordance with EN 60068-2-14 <sup>3)</sup> Included with the Starter Set

<sup>4)</sup> Mounting (e.g. control cabinet) <sup>5)</sup> Housing

Accessories:

Page 118

Technical documentation on the safe camera systems SafetyEYE:

Webcode 7153

Training – Basic SafetyEYE Course:

Webcode 4001

Online information at [www.pilz.com](http://www.pilz.com)

## ▶ Emergency stop pushbutton PITestop

In accordance with the Machinery Directive, plant and machinery must be fitted with emergency stop equipment so that a hazard can be averted or reduced in the case of an emergency. That's why you should use the standard-compliant emergency stop pushbutton PITestop to shut down your system in a hazardous situation.



PIT es3s



PIT es1u

PITestop are available with and without imprinted emergency stop symbol. If the emergency stop is imprinted, the standardized emergency stop symbol must be used in accordance with EN ISO 13850.

### Enhanced protection from the safety professionals

In a dangerous situation, emergency stop control devices are operated manually, triggering a signal to halt a potentially hazardous movement. By generating the emergency stop command the emergency stop control device is latched in. This must be maintained until the control device is released manually.

### Safe all over the world

For worldwide use, the emergency stop pushbuttons PITestop meet all the relevant international standards and regulations, such as EN/IEC 60947-5-1, EN/IEC 60947-5-5 and EN ISO 13850. Suitable for applications up to SIL CL 3 of EN/IEC 62061 and PL e of EN ISO 13849-1, they also meet UL and CE requirements. Designed to protection type IP65, the pushbutton is released by turning it to the left or right. A black stripe around the shaft is covered when the mushroom-type pushbutton is operated, thereby indicating the switch position.

### Contact block with monitoring

Pilz offers contact blocks with monitoring. "Self monitoring" is a N/O contact connected in series, which breaks the circuit in the event of a fault. This additional function provides a fast, safe solution for panel mount applications, at no extra cost.

### Type code for PITestop

#### PIT es Set1s-5cs

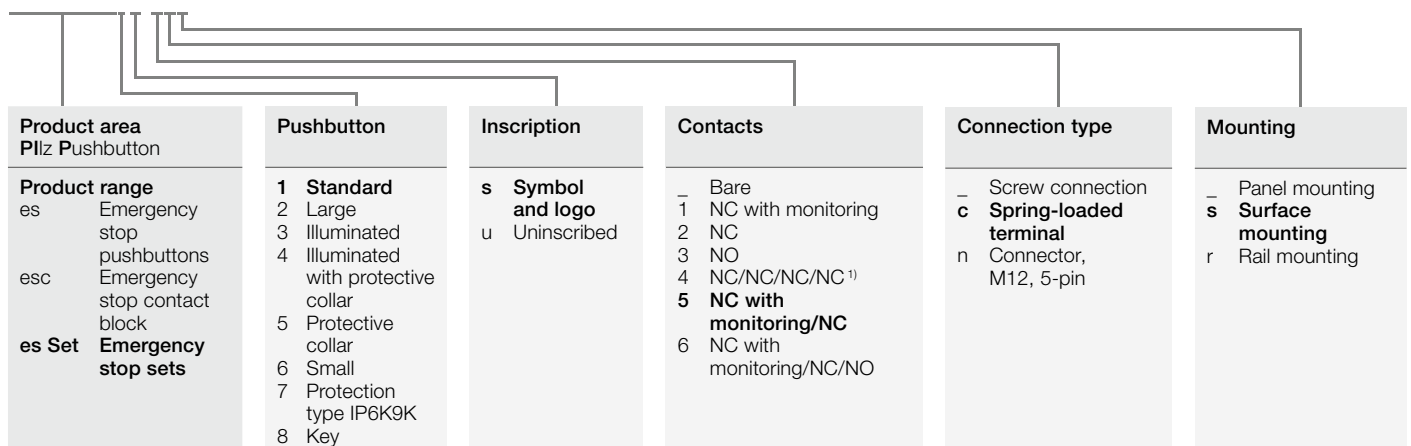

<sup>1)</sup> Used for parallel operation of two machines



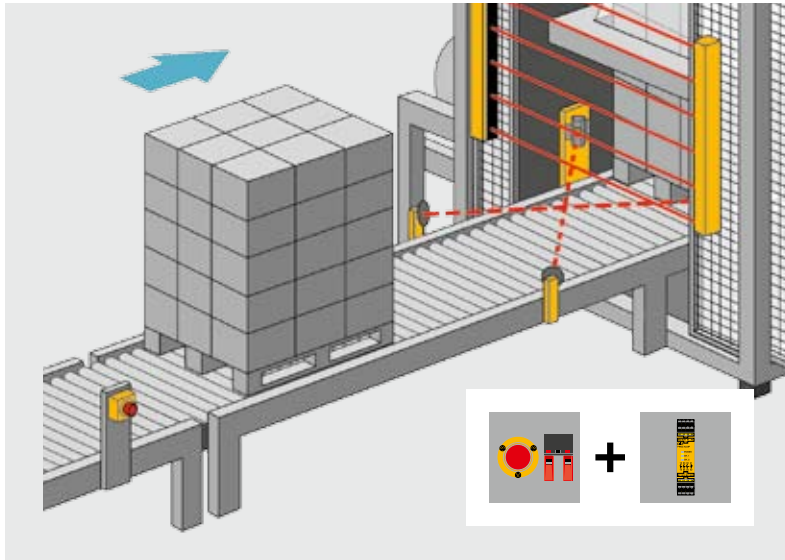

The optimum solution: emergency stop pushbutton PIT es Set1s-5c and safety relay PNOZ X2.8PC.

**Your benefits at a glance**

- ▶ Standard-compliant mushroom-type pushbutton for emergency stop
- ▶ A variety of emergency stop pushbuttons provide the highest level of safety in every situation: illuminated, with key, for hygiene environments (IP6K9K)
- ▶ Fast, easy assembly through panel and surface mount version as well as push-in technology
- ▶ Contact blocks and pushbuttons can be individually combined thanks to the modular structure
- ▶ Emergency stop symbol removes the need for additional labelling in the operator's language
- ▶ Enhanced operational safety thanks to contact block with monitoring (panel mount version)

**Push-in technology**

Spring-loaded terminals (push-in technology) make PITestop easy to install and robust against vibration.

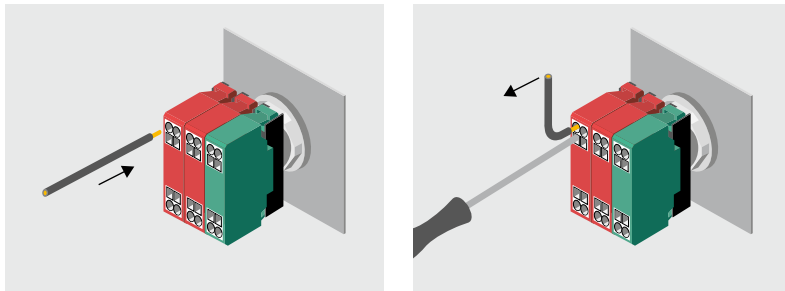

Reduce installation expense with quick-connect technology (push-in technology).

**You can assemble modular emergency stop pushbuttons PITestop – Example:**

	PIT pushbutton	Contact block bracket	Contact block	Optional: Surface mount housing
<b>Type</b>	PIT es1s	PIT MHR 3	PIT esc1	PIT es box
<b>Order number</b>	400 131	400 330	400 315	400 200

Keep up-to-date on emergency stop pushbutton PITestop:

Webcode 5294

Online information at [www.pilz.com](http://www.pilz.com)

## ► Selection guide – PITestop

The choice is yours: pre-assembled sets or modular compilation.

### Sets for panel mounting

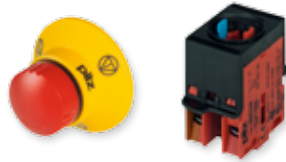

PIT es Set1s-5



PIT es Set3s-5c

Type	Components
PIT es Set1s-1	PIT es1s, PIT MHR3, PIT esc1
PIT es Set1s-1c	PIT es1s, PIT es holder3c, PIT esc1c
PIT es Set1s-5	PIT es1s, PIT MHR3, PIT esc1, PIT esc2
PIT es Set1s-5c	PIT es1s, PIT es holder3c, PIT esc1c, PIT esc2c
PIT es Set2s-5	PIT es2s, PIT MHR3, PIT esc1, PIT esc2
PIT es Set2s-5c	PIT es2s, PIT es holder3c, PIT esc1c, PIT esc2c
PIT es Set3s-5	PIT es3s, PIT MHR3, PIT esc1, PIT esc2
PIT es Set3s-5c	PIT es3s, PIT es holder3c, PIT esc1c, PIT esc2c
PIT es Set5s-5	PIT es5s, PIT MHR3, PIT esc1, PIT esc2
PIT es Set5s-5c	PIT es5s, PIT es holder3c, PIT esc1c, PIT esc2c
PIT es Set6.1	PIT es6.10, PIT esb6.10, without monitoring
PIT es Set7u-5	PIT es7u, PIT MHR3, PIT esc1, PIT esc2
PIT es Set7u-5c	PIT es7u, PIT es holder3c, PIT esc1c, PIT esc2c
PIT es Set8s-5	PIT es8s, PIT MHR3, PIT esc1, PIT esc2
PIT es Set8s-5c	PIT es8s, PIT es holder3c, PIT esc1c, PIT esc2c
PIT es Set1s-6	PIT es1s, PIT MHR3, PITesc1, PIT esc2, PIT esc3
PIT es Set1s-6c	PIT es1s, PIT es holder3c, PIT esc1c, PIT esc2c, PIT esc3c

### Sets for surface mounting



PIT es Set1s-5s



PIT es Set6u-5nr

Type	Components
PIT es Set1s-5s	PIT es1s, PIT MHR3, PIT esc1, PIT esc2, PIT es box
PIT es Set1s-5cs	PIT es1s, PIT es holder3c, PIT esc1c, PIT esc2c, PIT es box
PIT es Set3s-5s	PIT es3s, PIT MHR3, PIT esc1, PIT esc2, PIT es box
PIT es Set5s-5s	PIT es5s, PIT MHR3, PIT esc1, PIT esc2, PIT es box
PIT es Set6u-5cr	Emergency stop, narrow surface mount housing for rail assembly
PIT es Set1s-6s	PIT es1s, PIT MHR3, PIT esc1, PIT esc2, PIT esc3, PIT es box
PIT es Set1s-5ns	PIT es1s, PIT MHR3, PIT esc1, PIT esc2, PIT es box
PIT es Set3s-5ns	PIT es3s, PIT MHR3, PIT esc1, PIT esc2, PIT es box
PIT es Set6u-5nr	Emergency stop, narrow surface mount housing for rail assembly

Contacts	Inscribed with emergency stop symbol and logo		Can be combined with surface mount housing	Order number	
	With	Without		Screw terminal	Spring-loaded terminal
	◆		◆	400 430	-
	◆		◆	-	400 431
	◆		◆	400 432	-
	◆		◆	-	400 433
	◆		◆	400 434	-
	◆		◆	-	400 435
	◆		◆	400 436	-
	◆		◆	-	400 437
	◆		◆	400 438	-
	◆		◆	-	400 439
		◆		400 620	-
		◆	◆	400 441	-
		◆	◆	-	400 442
	◆		◆	400 443	-
	◆		◆	-	400 444
	◆		◆	400 445	-
	◆		◆	-	400 446

Contacts	Inscribed with emergency stop symbol and logo		Order number		
	With	Without	Screw terminal	Spring-loaded terminal	5-pin M12 connection
	◆		400 447	-	-
	◆		-	400 448	-
	◆		400 449	-	-
	◆		400 450	-	-
		◆	-	400 451	-
	◆		400 452	-	-
	◆		-	-	400 453
	◆		-	-	400 454
		◆	-	-	400 455

N/C, positive-opening

N/O, signal contact

Keep up-to-date on emergency stop pushbutton PITestop:

Webcode 5294

Online information at [www.pilz.com](http://www.pilz.com)

## ► Technical details – PITestop

### Emergency stop pushbutton

#### Common features

- Application range:  
EN/IEC 60947-5-1  
and EN/IEC 60947-5-5
- Protection type: IP65; PIT es7u: IP6K9K
- Mounting hole: 22.3 mm
- 127 500 operations
- Connection options:  
Connection to contact blocks  
of type PIT esc
- Dimensions:  
see dimensioned drawings
- Pushbutton color: red
- Twist to release:  
clockwise or counter clockwise;  
PIT es8s and PIT es8u:  
clockwise only



PIT es1s



PIT es2s



PIT es3s



PIT es5s



PIT es6.10



PIT es8s

#### Type

PIT es1s
PIT es1u
PIT es2s
PIT es2u
PIT es3s
PIT es3s-c
PIT es3u
PIT es3u-c
PIT es4s
PIT es4u
PIT es5s
PIT es5u
PIT es6.10
PIT es7u
PIT es8s
PIT es8u

#### Dimensions

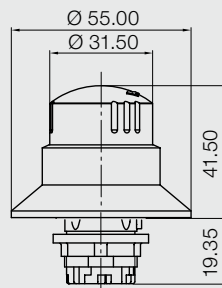

PIT es1s/PIT es1u

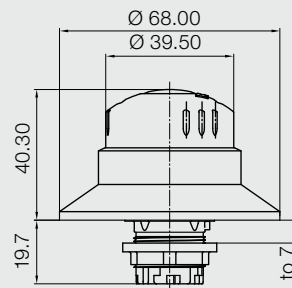

PIT es2s/PIT es2u

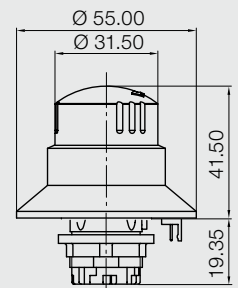

PIT es3s/PIT es3u



Pushbutton	Order number	
	Inscribed with emergency stop symbol and logo	
	With	Without
Standard	400 131	-
Standard	-	400531
Large	400 132	-
Large	-	400532
Illuminated, incl. contact block (screw terminal)	400 133	-
Illuminated, incl. contact block (spring-loaded terminal)	400 143	-
Illuminated, incl. contact block (screw terminal)	-	400533
Illuminated, incl. contact block (spring-loaded terminal)	-	400543
Illuminated with protective collar, incl. contact block (screw terminal)	400 134	-
Illuminated with protective collar, incl. contact block (screw terminal)	-	400534
With protective collar	400 135	-
With protective collar	-	400535
Small	-	400610
Protection type IP6K9K	-	400537
Key	400 138	-
Key	-	400538

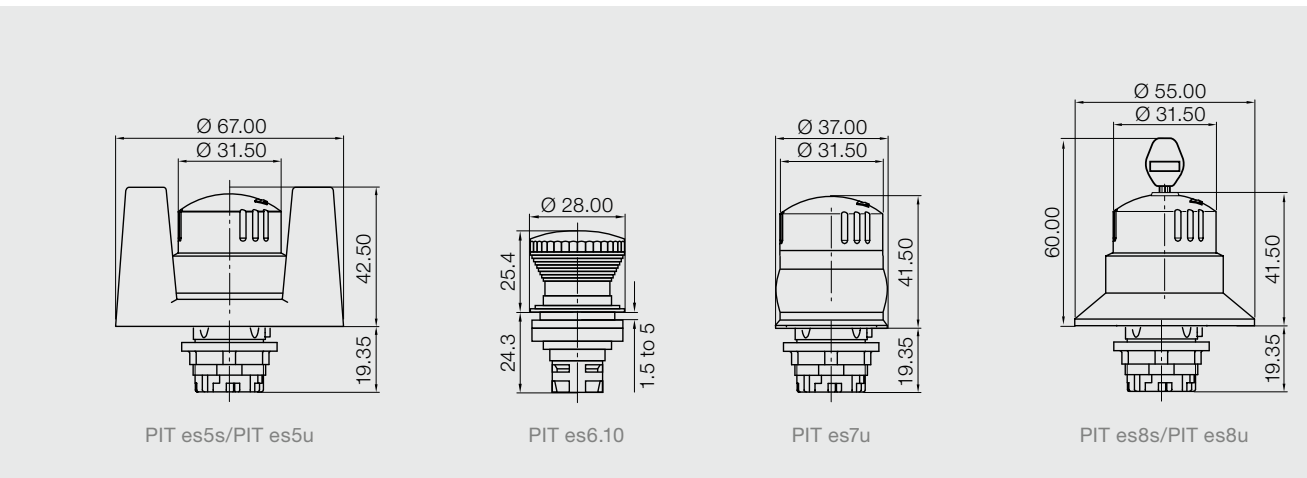

Keep up-to-date on emergency stop pushbutton PITestop:

Webcode 5294

Online information at [www.pilz.com](http://www.pilz.com)

## ► Technical details – PITestop

### Contact blocks for panel and surface mounting

#### Common features

- Application range:
  - SIL CL 1, 2 or 3 of EN/IEC 62061,
  - PL c, d or e of EN ISO 13849-1,
  - EN/IEC 60947-5-1
- Rated operating voltage  $U_e$ :
  - 250 VAC (3 A), 24 VDC (2 A)
- Connection:
  - Screw connections  $2 \times 2.5 \text{ mm}^2$ ,
  - finger-proof in accordance with VBG 4
- Contact material: Hard silver Ag/Ni
- Min. current:
  - 1 mA (screw terminals)
  - 5 mA (spring-loaded terminals)
- Min. voltage: 5 V
- Mounting type: Panel mount
- Mounting depth:
  - Screw terminals: 59 mm
  - Spring-loaded terminals: 52 mm



PIT esc1



PIT esc2c



PIT esc3



PIT esb6.10

#### Type

PIT esc1
PIT esc2
PIT esc3
PIT esc4
PIT esc1c
PIT esc2c
PIT esc3c
PIT esb6.10

### Accessories



PIT es box



PIT es backplate symbol



PIT MHR3



PIT MHR5



PIT es holder3c

#### Type

PIT es box
PIT MHR3
PIT MHR5
PIT es holder3c
PIT es backplate symbol
PIT es backplate language

### PIT connected to safe control technology (examples)















PSEN ix1



PNOZ mm0p

#### Type

PSEN ix1
PNOZ mm0p

Method	Contacts	Order number	
		Screw terminal	Spring-loaded terminal
Contact block with monitoring		400 315	-
Contact block		400 320	-
Contact block		400 310	-
4 contact blocks for operation of 2 parallel machines	   	400 324	-
Contact block with monitoring		-	400 316
Contact block		-	400 321
Contact block		-	400 311
Contact block	 	-	400 360

 N/C, positive-opening

 N/O, signal contact

Method	Features	Order number
Surface mount housing for use in combination with PITestop pushbuttons and contact blocks	Protection type: IP65, protection class: II, 2 perforated openings for the stuffing box connection, cable entry ISO 20 mm (PG13.5), dimensions (H x W x D) in mm: 61.5 x 72 x 72, also available as a pre-assembled set, see Page 78	400 200
Contact block bracket for screw connections	3 slots	400 330
Contact block bracket for screw connections	5 slots, max. 3 contact blocks may be fitted to ensure protection against defeat	400 340
Contact block bracket for spring-loaded connections	3 slots	400 331
Backplate with 3 emergency stop symbols	Suitable for all pushbuttons except PIT es2 and PIT es5 – not suitable for the PIT es box and the narrow, surface mount housing	400 334
Backplate with emergency stop text in 3 languages: English, French, German	Suitable for all pushbuttons except PIT es2 and PIT es5 – not suitable for the PIT es box and the narrow, surface mount housing	400 335

Method	Features	Order number
Multiple interface for PIT es Set1s-5 (400 432), for example	<ul style="list-style-type: none"> <li>▶ Connection of several emergency stop pushbuttons or safety switches to PNOZ safety relays</li> <li>▶ Max. 13 PSEN ix1 can be connected in series</li> <li>▶ Connection of max. 50 emergency stop pushbuttons</li> <li>▶ Volt-free signal outputs to evaluate the switch status</li> <li>▶ Connection via spring-loaded terminals</li> </ul>	535 120
Configurable small control systems PNOZmulti Mini e.g. for monitoring emergency stop pushbutton PIT es Set3s-5 (400 436)	Can be configured with PNOZmulti Configurator, exchangeable program memory, 20 inputs, 4 safe semiconductor outputs (SIL CL 3), 4 test pulse outputs, supply voltage 24 VDC, voltage/current/power: 24 VDC/2 A/48 W, outputs in semiconductor technology, dimensions H x W x D in mm: 102/98 x 45 x 120	772 000



## ▶ Operating mode selector switch PITmode

The operating mode selector switch PITmode provides two functions in one compact unit: selection of operating mode and authorization control for machine access. PITmode safely displays operating mode and authorization via LED; the display is also protected against manipulation. The evaluation device safely detects the operating mode and switches over reliably.



PIT m3.2p

The coded key gives every user the machine enables that match his abilities. Identification numbers can be used to assign authorizations in the machine control system, which serve as access authorizations or password levels. As an option, the operating mode selector switch is also available with pictograms for machine tools – ideal for international applications.

PITmode can be used on plant and machinery in which a range of control sequences and operating modes are used.

### **The safe, complete solution**

The evaluation device safely identifies and evaluates the selected operating mode. Pilz supplies a series of evaluation devices that are suitable for use with PITmode:

- ▶ Configurable safety system PNOZmulti, configurable small control system PNOZmulti Mini and configurable control system PNOZmulti 2
- ▶ Programmable control systems PSS
- ▶ Control systems from the automation system PSS 4000



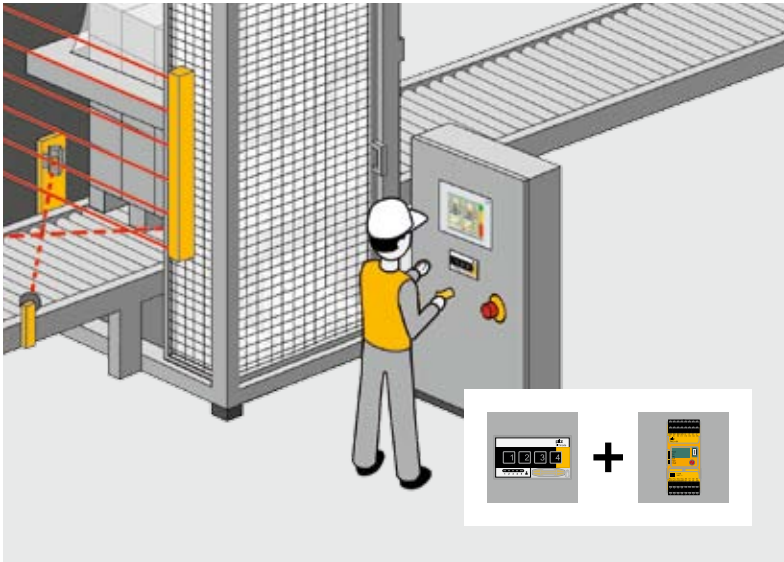

The optimum solution: select operating modes with PITmode and the configurable control system PNOZmulti 2.

**Your benefits at a glance**

- ▶ Safe switching of operating mode through self-monitoring
- ▶ Saves space, as operating mode selector switch and access authorization are combined in one unit
- ▶ Pushbuttons available with/without pictograms for machine tools
- ▶ High level of manipulation protection through universal coding
- ▶ Rapid identification of the selected operating mode and authorization level via LED

**Dimensions**

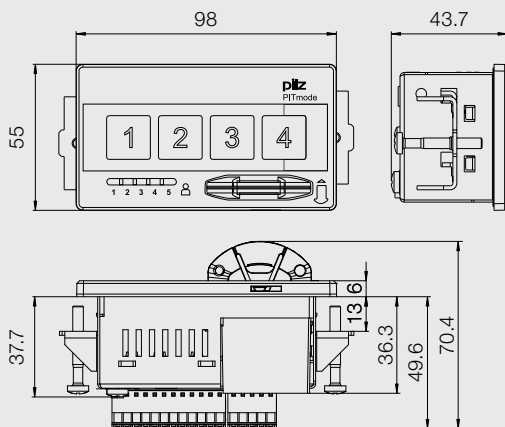

**Higher level standard control system**

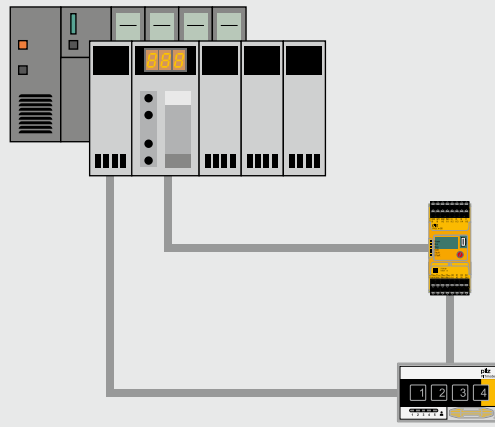

The safe, complete solution: PITmode and configurable control system PNOZmulti 2.

Keep up-to-date on operating mode selector switches PITmode:

 Webcode 6422

Online information at [www.pilz.com](http://www.pilz.com)

## ► Technical details – PITmode

### Selection guide – Operating mode selector switch PITmode



PIT m3.1p



PIT m3.2p



PIT m3 key mode 2

Type	Technical features
<b>PIT m3.1p</b>	Operating mode selector switch: Keys with digits
<b>PIT m3.2p</b>	Operating mode selector switch: Keys with digits
<b>PIT m3.2p machine tools pictogram</b>	Operating mode selector switch: Keys with digits and pictograms for machine tools
<b>PIT m3.3p</b>	Operating mode selector switch: Keys with digits
<b>PIT m3.3p machine tools pictogram</b>	Operating mode selector switch: Keys with digits and pictograms for machine tools
<b>PITmode starter set</b>	Starter set consisting of: <ul style="list-style-type: none"> <li>▶ PIT m3.2p machine tools pictogram</li> <li>▶ PIT m3p key mode 1</li> <li>▶ PIT m3p key mode 2</li> <li>▶ PIT m3p key mode 3</li> <li>▶ PIT m3p key mode 4</li> <li>▶ PIT m3p key service</li> <li>▶ PIT m3.2p terminal set spring load</li> <li>▶ Screwdriver</li> </ul>
<b>PIT m3p key mode 1</b>	Transponder key, authorization 1
<b>PIT m3p key mode 2</b>	Transponder key, authorization 2
<b>PIT m3p key mode 3</b>	Transponder key, authorization 3
<b>PIT m3p key mode 4</b>	Transponder key, authorization 4
<b>PIT m3p key service</b>	Transponder key, service function
<b>PIT m3.1p terminal set spring load</b>	Spring loaded terminals (1 set) for PIT m3.1p
<b>PIT m3.2p terminal set spring load</b>	Spring loaded terminals (1 set) for PIT m3.2p
<b>PIT m3.2p screw terminal set angled</b>	Screw terminals, angled (1 set) for PIT m3.2p
<b>PIT m3.2p screw terminal set</b>	Screw terminals, straight (1 set) for PIT m3.2p

	Dimensions (H x W x D) in mm	Order number
<ul style="list-style-type: none"> <li>▶ Number of selectable operating modes:                             <ul style="list-style-type: none"> <li>- PIT m3.1p, PIT m3.2p, PIT m3.2p machine tools pictogram: 5</li> <li>- PIT m3.3p, PIT m3.3p machine tools pictogram: 3</li> </ul> </li> <li>▶ Operating mode selected via operator keys</li> </ul>	97 x 116 x 46	402 220
<ul style="list-style-type: none"> <li>▶ The evaluation device safely identifies and evaluates the selected operating mode (non-contact with key via RFID technology)</li> </ul>	55 x 98 x 42.3	402 230
<ul style="list-style-type: none"> <li>▶ Evaluation with safe evaluation devices PNOZmulti, PSS and control systems from the automation system PSS 4000</li> <li>▶ Identification management, i.e. access and task authorizations can be assigned in the higher level standard control system</li> </ul>	55 x 98 x 42.3	402 231
<ul style="list-style-type: none"> <li>▶ Mode of operation: Transponder technology</li> <li>▶ Supply voltage: 24 VDC -15 % ... 10 %</li> <li>▶ Ambient temperature: 0 ... +55 °C</li> <li>▶ Protection type: IP54 (installed)</li> </ul>	55 x 98 x 42.3	402 240
<ul style="list-style-type: none"> <li>▶ Safety-related characteristic data:                             <ul style="list-style-type: none"> <li>- PL d of EN ISO 13849-1</li> <li>- SIL CL 2 of EN/IEC 62061</li> </ul> </li> </ul>	55 x 98 x 42.3	402 241
	-	402 299
	-	402 211
	-	402 212
	-	402 213
	-	402 214
	-	402 215
	-	402 301
	-	402 302
	-	402 303
	-	402 305

Keep up-to-date  
on operating mode  
selector switches  
PITmode:

 Webcode 6422

Online information  
at [www.pilz.com](http://www.pilz.com)

## ▶ Manually operated control device PITjog

The manually operated control device PITjog can be used as an enabling switch. For example it is used when processes within the plant or machine's danger zone are being monitored while the safety gate is open.



PIT js2

### Safe within the danger zone

In contrast to a conventional enabling switch, both hands are required to operate the PITjog. Access to the danger zone using one hand, whether by carelessness or accident, is prevented. Additional protection measures may be required depending on the result of the risk analysis.

### The complete solution

Add the final touch to your solution! Allow staff to work safely within the danger zone of your plant or machine in conjunction with approved evaluation devices from Pilz:

- ▶ Two-hand control devices P2HZ
- ▶ Safety relay PNOZ s6
- ▶ Safety relay PNOZ e2.1p
- ▶ Two-hand module from the modular safety system PNOZmulti
- ▶ Programmable control systems PSS with standard function block SB059
- ▶ Control systems from the automation system PSS 4000

### Selection guide – Manually operated control device PITjog



PIT js holder

Type	Method	Operating voltage	Ambient temperature	Protection type
PIT js2	Manually operated control device	24 VAC/DC	-10 °C ... +55 °C	IP50
PIT js holder	Wall holder for PIT js2	-	-	-



The optimum solution: two-hand monitoring with the manually operated control device PITjog and the safety relay PNOZ s6.

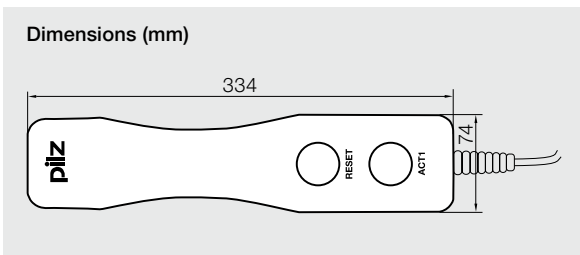

Dimensions (H x W x D) in mm	Housing material	Coiled cable		Order number
		Length	Length, stretched	
334 x 74 x 60	PC-ABS blend UL 94V0	1 m	4 m	401 100
310 x 83 x 71.5	Rust-proof steel	-	-	401 200

Keep up-to-date on the manually operated control device PITjog:

 Webcode 5302

Online information at [www.pilz.com](http://www.pilz.com)

## ▶ Enabling switch PITenable

Safe setup and maintenance with one hand – the enabling switch PITenable is a manually operated control device. It is used when working inside the danger zone of a plant or machine, when the effect of the safeguard has to be suspended, e.g. during setup or maintenance. The 3 stages allow the PITenable to be operated with one hand.



PIT en1.0p-5m-s

### 3-fold safe enabling, off-on-off

Operation is in three stages: In stage 1, the switch is not operated.

The machine runs with the safety functions activated. Stage 2 activates the enabling function; the switch is in its middle setting. The machine runs while the protective effect of the movable guards is suspended. Stage 3 is a protective function which brings the machine to a standstill if the switch is suddenly released or fully depressed. This function protects the operator, should he overreact in a shock situation.

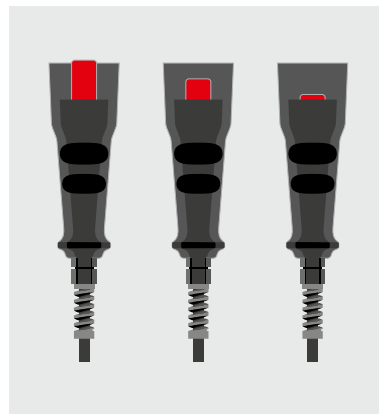

3-stage enabling switch: off-on-off.



### Selection guide – Enabling switch PITenable



PIT en1.0

Type	Method	Connection
PIT en1.0p-5m-s	Enabling switch, 3-stage	Male connector, M12, 5-pin
PIT en1.1a-5m-s	Enabling switch, 3-stage	Open coiled cable
PIT en1.0a-5m-s	Enabling switch, 3-stage	Open cable
PIT en1.0 holder	Wall holder for PIT en	



Safety with the approved all-in-one solution: to evaluate the PITenable Pilz offers the safe evaluation devices PNOZmulti, PSS and the control systems of the automation system PSS 4000.

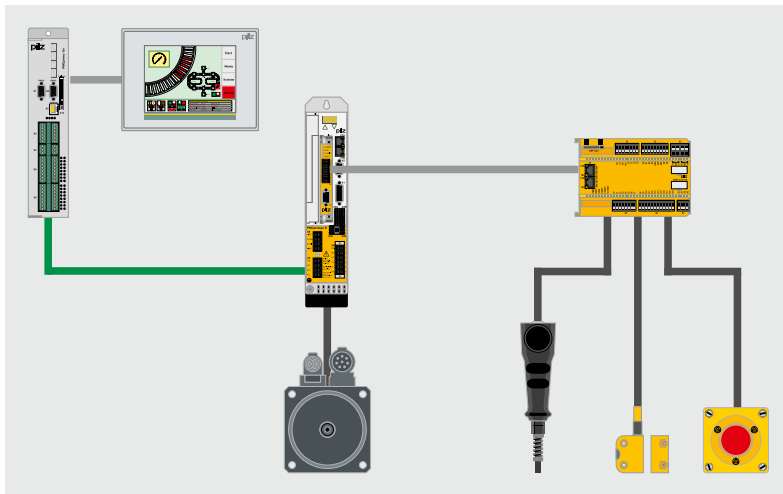

The safe, all-in-one solution with safe control and drive technology.

**Your benefits at a glance**

- ▶ Ability to work safely inside a plant or machine's danger zone
- ▶ Easy to monitor processes with the safety gate open
- ▶ Flexible one-handed operation thanks to 3-stage enabling switch
- ▶ Operator is protected should he overreact with shock or panic
- ▶ Ergonomically moulded housing for comfortable operation
- ▶ Maintenance-free
- ▶ High manipulation protection

**Dimensions (mm)**

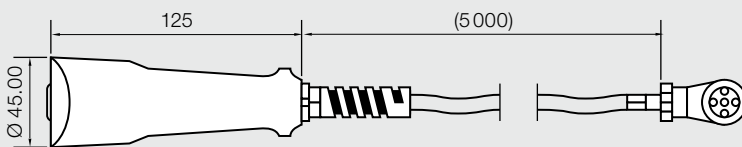

**Technical features**

- ▶ Color: black
- ▶ Operating temperature: 0 °C ... 50 °C
- ▶ Front protection type: IP65
- ▶ Electrical life: min. 100 000 cycles
- ▶ Operating voltage/current: 125 VAC/0.3 A or 30 VDC/0.7 A
- ▶ Housing material: polypropylene
- ▶ Length of connection cable: 5 m
- ▶ Safety-related characteristic data: B<sub>10d</sub> 100 000 operations

**Order number**

- 401 110
- 401 112
- 401 111
- 401 201

Keep up-to-date on the manually operated enabling switch PITenable:

 Webcode 6676

Online information at [www.pilz.com](http://www.pilz.com)

## ▶ Decentralized modules PDP67 and PDP20

With the PDP67 modules you can achieve a high level of decentralization. The digital input module monitors safety functions in the field and enables up to 64 sensors to be connected (PSEnmag, PSENcode, PSEnini, PSENSlock, PSENmech and PSENhinge).



PDP67 F 8DI ION

### Decentralized and passive – decentralized safety

The passive junction collects and forwards the signals and can be connected to up to four sensors (PSEnini, PSENcode and PSENSlock).

The ability to connect to various evaluation devices such as PNOZmulti, PNOZmulti Mini, PNOZsigma, or in the future, PSS 4000 control systems, enables a wide range of automation architectures.

### PDP67 – Economical and safe

Integrated in dirt and water-repellent IP67 housings, the PDP67 modules can even be used where there are high demands on hygiene. The decentralized modules optimize the installation and wiring effort by removing the need for additional, cost-intensive hardware, such as a control cabinet for example.

### Type code for decentralized modules PDP67

PDP67 F 8DI ION HP VA

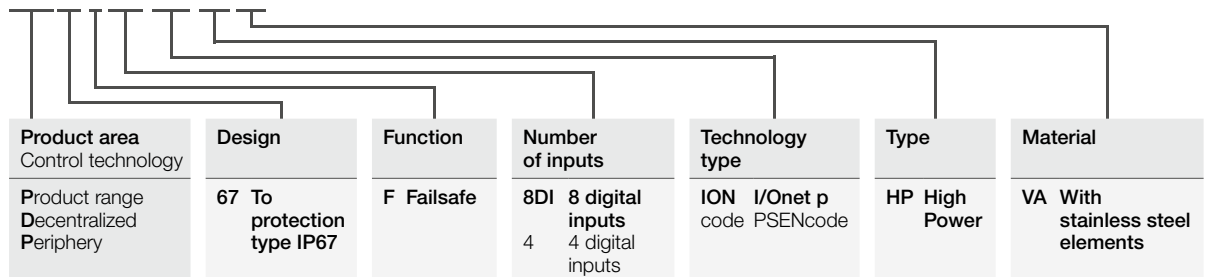

Keep up-to-date  
on decentralized  
modules: PDP67

 Webcode 6557

PDP20

 Webcode 8459

Online information  
at [www.pilz.com](http://www.pilz.com)



PDP20

**PDP20 – Series connection up to PL e**

The interface module PDP20 F 4 mag is ideally suitable for series connection of contact-based sensors, with N/O / N/O contacts such as PSEnmag, up to PL e. As such it provides a standard-compliant solution in accordance with EN ISO 13849-1. The interface module can be connected to dual-channel evaluation devices (e.g. PNOZsigma, PNOZmulti, PSS, ...). Up to four sensors can be connected to each PDP20 module.

There is also the option of cascading the PDP20 modules. In this case each cascaded module will provide another three sensor interfaces.

**Your benefits at a glance**

- ▶ Simple installation means less planning, design and installation work
- ▶ Easy to implement a modular machine concept
- ▶ Just one cable for communication and supply, plug and play via M12 plug-in connector
- ▶ Simple diagnostics due to a point-to-point connection between the modules (each module can be identified)
- ▶ Individual sensors can be diagnosed on the modules



**Selection guide – Modules for alternative connection options for sensors**



PDP67 F 8DI ION HP



PDP67 F 4 code



PDP20 F 4 mag

Type	Features	Safety	Order number
PDP67 F 8DI ION, PDP67 F 8DI ION VA	Decentralized input module for PNOZmulti and PNOZmulti Mini	▶ PL e of EN ISO 13849-1 ▶ SIL CL 3 of EN/IEC 62061	▶ PDP67 F 8DI ION _____ 773 600
			▶ PDP67 F 8DI ION VA ____ 773 614
PDP67 F 8DI ION HP, PDP67 F 8DI ION HP VA	Decentralized input module for PNOZmulti and PNOZmulti Mini; High Power; additional power supply for PSENSlock and PSENopt		▶ PDP67 F 8DI ION HP ____ 773 601
			▶ PDP67 F 8DI ION HP VA _ 773 615
PDP67 F 4 code, PDP67 F 4 code VA	Passive junction PSENcode		▶ PDP67 F 4 code _____ 773 603
			▶ PDP67 F 4 code VA ____ 773 613
PDP67 Connector cs, PDP67 Connector cs VA	Adapter for connection cable to the evaluation device	-	▶ PDP67 Connector cs ____ 773 610
			▶ PDP67 Connector cs VA _ 773 612
PDP20 F 4 mag	Decentralized interface for series connection PSEnmag	▶ PL e of EN ISO 13849-1 ▶ SIL CL 3 of EN/IEC 62061	773 310
PSEN Y junction M8-M12/M12	Cable separator, M8, 8-pin	-	540 327
PSEN Y junction M12-M12/M12	Cable separator, M12, 8-pin	-	540 328
PSEN T junction M12	Diagnostic connector M12, 8-pin	-	540 331

## ► Cable accessories for sensor technology PSEN®

### Safe, complete solutions

The sensor technology product area PSEN includes an extensive portfolio of accessories in addition to devices for position monitoring, safety switches, safety gate systems, light beam devices and safe camera systems.

Pilz products can be connected in series and are compatible with products and interfaces from other manufacturers. They fit perfectly into your plant environment and also enable Pilz components to be retrofitted to your plant.

Select the appropriate accessories to meet your requirements and assemble your own individual system solution!

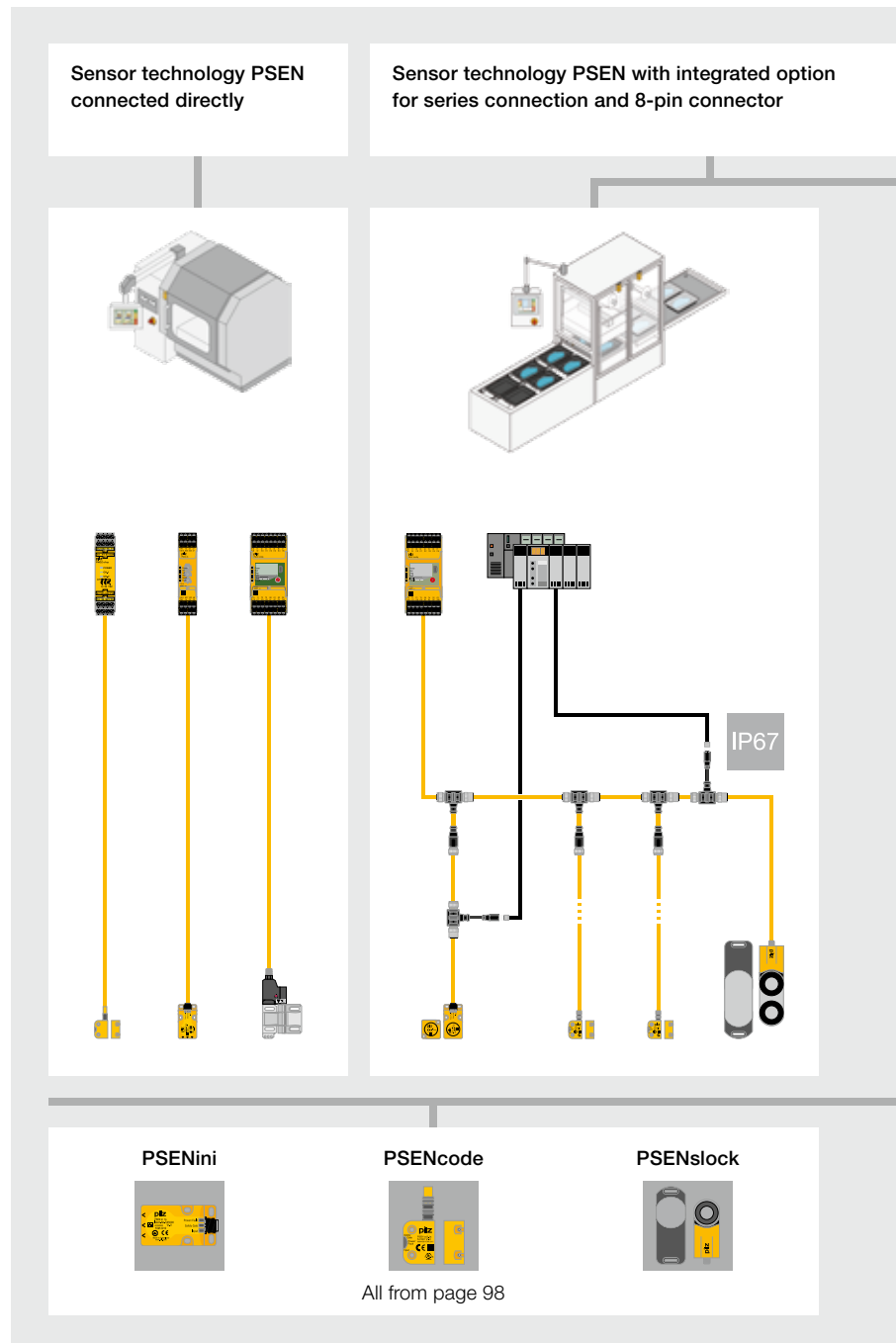

### Type code for cable accessories

#### PSEN cable M8-8sf

Product area Pilz SENSors	Diameter of thread	Number of poles	Connector design	Connector type
<b>Cable</b>	<b>M8</b> 8 mm <b>M12</b> 12 mm	4 4-pin 5 5-pin <b>8 8-pin</b>	<b>s</b> Straight <b>a</b> Angled	<b>m</b> Pin connector (male) <b>f</b> Socket (female)

Sensor technology PSEN with 5-pin connector for PDP67 F 8DI ION and PNOZmulti

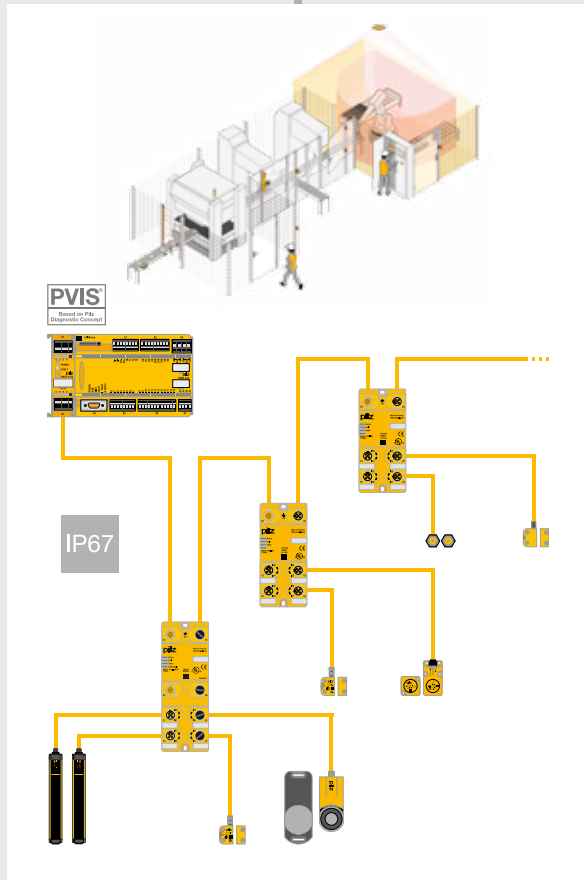
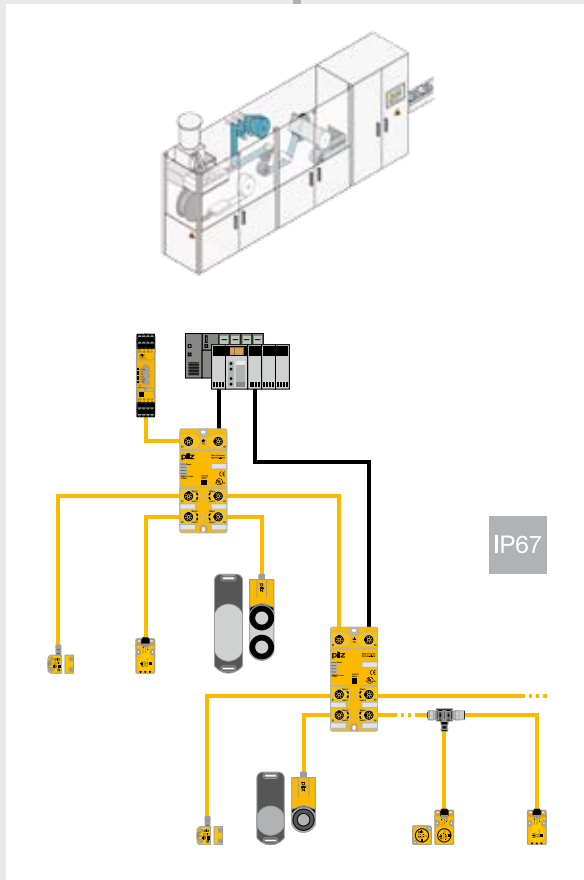

PSENmech



All from page 100

PSENrope



PSENmag



From page 102

PSENhinge



From page 104

PSENopt



From page 104



## ► Selection guide – Cable for PSENIini, PSENIcode



PSENIini



PSENIcode



PSENIlock

### PSENIini, PSENIcode and PSENIlock – Cable selection for connection to any evaluation device



PSENI cable M8-8sf

Type	Description
PSENI cable M8-8sf	Cable for connection to any evaluation device
PSENI cable M12-8sf	
PSENI cable M12-8af	
PSENI cable M12-5sf	
PSENI cable M12-5af	
PSENI cable M12-5af	

### PSENIini, PSENIcode and PSENIlock – Cable selection for series connection



PSENI Y junction M12-M12/M12



PSENI cable M8-8sf M8-8sm

Type	Description
PSENI Y junction M8-M12/M12	Cable separator
PSENI Y junction M12-M12/M12	Cable separator
PSENI T junction M12	Diagnostic connector
PSENI cable M8-8sf M8-8sm	Extension cable
PSENI cable M8-8sf M8-8sm	Extension cable
PSENI cable M8-8sf M8-8sm	Extension cable
PSENI cable M12-8sf M12-8sm	Cable

### PSENIini, PSENIcode and PSENIlock – Cable selection for connection to PDP67 F 4 code



PSENI cable M12-8sf



PDP67 F 4 code

Type	Description
PSENI cable M12-8sf M12-8sm	Cable for connection to PDP67 F 4 code
PSS67/PDP67 cable M12-8sm	Cable for connection to any evaluation device

Type	Description
PDP67 F 4 code	Passive junction for PSENIcode

# and PSEnSlock

Features		Order number (by length)					
Connection 1	Connection 2	2 m	3 m	5 m	10 m	20 m	30 m
Straight, M8, 8-pin, socket	Open cable	533 150	-	533 151	533 152	533 153	533 154
Straight, M12, 8-pin, socket		-	540 319	540 320	540 321	540 333	540 326
Angled, M12, 8-pin, socket		-	540 322	540 323	540 324	-	540 325
Straight, M12, 5-pin, socket		-	630 310	630 311	630 312	630 298	630 297
Angled, M12, 5-pin, socket		-	630 347	630 348	630 349	-	630 350

Features	Order number
Series connection PSEN cs3.xx/PSEN cs4.xx with M8 connector, 8-pin	540 327
Series connection PSENcode, PSEnNini, PSEnSlock with M12 connector, 8-pin	540 328
<ul style="list-style-type: none"> <li>▶ PSEnNini, PSENcode, PSEnSlock: Signal output</li> <li>▶ PSEnSlock: Lock signal</li> </ul>	540 331
0.5 m, straight, M8, 8-pin, plug/socket	533 155
1 m, straight, M8, 8-pin, plug/socket	533 156
2 m, straight, M8, 8-pin, plug/socket	533 157
5 m (see table below for additional cable lengths)	540 341

Features		Order number (by length)					
Connection 1	Connection 2	2 m	3 m	5 m	10 m	20 m	30 m
Straight, M12, 8-pin, socket	Straight, M12, 8-pin, plug	540 340	-	540 341	540 342	540 343	540 344
Straight, M12, 8-pin, plug	Open cable	380 700	-	380 701	380 702	380 703	380 704

Features	Order number
<ul style="list-style-type: none"> <li>▶ Multiple interface PDP67, protection type IP67</li> <li>▶ Series connection up to PL e of EN ISO 13849-1, SIL CL 3 of EN/IEC 62061 and Cat. 4 of EN 954-1</li> </ul>	773 603



## ► Selection guide – Cable for PSENIini, PSENIcode, PSENIlock



PSENIini



PSENIcode



PSENIlock

### PSENIini, PSENIcode and PSENIlock – Cable selection for connection to PDP67 F 8DI ION/PSS67



PSS67/PDP67 cable M12-5sf



PDP67 F 8DI ION

Type	Description
PSS67/PDP67 cable M12-5sf M12-5sm	Cable for connection to PDP67 F 8DI ION/PSS67
PSS67/PDP67 cable M12-5af M12-5am	

Type	Description
PDP67 F 8DI ION	Sensor junction box for decentralized periphery PNOZmulti

Type	Description
PDP67 cable M12-5sf M12-5sm	Extension cable



PSENI mech



PSENI rope

### PSENI mech and PSENI rope – Cable selection for connection to PDP67 F 8DI ION/PSS67



PSS67/PDP67 cable



PDP67 F 8DI ION

Type	Description
PSS67/PDP67 cable	Cable for connection to PDP67 F 8DI ION/PSS67

Type	Description
PDP67 F 8DI ION	Sensor junction box for decentralized periphery PNOZmulti

# PSENslock, PSENmech and PSENrope

Features		Order number (by length)					
Connection 1	Connection 2	2 m	3 m	5 m	10 m	20 m	30 m
Straight, M12, 5-pin, socket	Straight, M12, 5-pin, plug	-	380208	380209	380210	380220	380211
Angled, M12, 5-pin, socket	Angled, M12, 5-pin, plug	-	380212	380213	380214	-	380215

Features	Order number
Multiple interface PDP67, protection type IP67, PL e of EN ISO 13849-1, SIL CL 3 of EN/IEC 62061 and Cat. 4 of EN 954-1	773600

Features	Order number
0.5 m, straight, 5-pin, plug/socket	380710
1 m, straight, 5-pin, plug/socket	380712
1.5 m, straight, 5-pin, plug/socket	380711
2 m, straight, 5-pin, plug/socket	380713

Features		Order number (by length)					
Connection 1	Connection 2	2 m	3 m	5 m	10 m	20 m	30 m
Open cable	Straight, M12, 5-pin, plug	-	380705	380709	380706	380707	380708

Features	Order number
Multiple interface PDP67, protection type IP67, PL e of EN ISO 13849-1, SIL CL 3 of EN/IEC 62061 and Cat. 4 of EN 954-1	773600

## ▶ Selection guide – Cable for PSEnMag



PSEnMag



PSEnMag

### PSEnMag – Cable selection for connection to any evaluation device



PSEn cable M8-4sf

Type	Description
PSEn cable M8-4sf	Cable for connection to any evaluation device
PSEn cable M8-4af	
PSEn cable M8-8sf	
PSEn cable M12-8sf	
PSEn cable M12-8af	
PSEn cable M12-5sf	

### PSEnMag – Accessory selection for series connection



PSEn ix1

Type	Description
PSEn ix1	Multiple interface (PSEn 1 series), protection type IP20
PSEn i1	Multiple interface (PSEn 2 series), protection type IP20

### PSEnMag – Cable selection for connection to PDP67 F 8DI ION/PSS67



PSS67/PDP67 cable M12-5sf



PDP67 F 8DI ION

Type	Description
PSS67/PDP67 cable M12-5sf M12-5sm	Cable for connection to PDP67 F 8DI ION/PSS67
PSS67/PDP67 cable M12-5af M12-5am	
PSS67/PDP67 cable M8-4sf M12-5sm <sup>1)</sup>	
PSS67/PDP67 cable M8-4af M12-5am <sup>1)</sup>	

Type	Description
PDP67 F 8DI ION	Sensor junction box for decentralized periphery PNOZmulti

Features		Order number (by length)					
Connection 1	Connection 2	2 m	3 m	5 m	10 m	20 m	30 m
Straight, M8, 4-pin, socket	Open cable	533 111	-	533 121	533 131	-	533 141
Angled, M8, 4-pin, socket		533 110	-	533 120	533 130	-	533 140
Straight, M8, 8-pin, socket		533 150	-	533 151	533 152	533 153	533 154
Straight, M12, 8-pin, socket		-	540319	540320	540321	540333	540326
Angled, M12, 8-pin, socket		-	540322	540323	540324	-	540325
Straight, M12, 5-pin, socket		-	630310	630311	630312	630298	630297

Features	Order number
<ul style="list-style-type: none"> <li>▶ Series connection up to PL c of EN ISO 13849-1, SIL CL 1 of EN/IEC 62061 and Cat. 2 of EN 954-1</li> <li>▶ Can be used for connection to: PNOZsigma, PNOZpower, PNOZ X, PNOZmulti, PSS</li> </ul>	535 120
<ul style="list-style-type: none"> <li>▶ Series connection up to PL c of EN ISO 13849-1, SIL CL 1 of EN/IEC 62061 and Cat. 2 of EN 954-1</li> <li>▶ Can be used for connection to: PNOZelog, PNOZmulti, PSS</li> </ul>	535 110

Features		Order number (by length)					
Connection 1	Connection 2	2 m	3 m	5 m	10 m	20 m	30 m
Straight, M12, 5-pin, socket	Straight, M12, 5-pin, plug	-	380208	380209	380210	380220	380211
Angled, M12, 5-pin, socket	Angled, M12, 5-pin, plug	-	380212	380213	380214	-	380215
Straight, M8, 4-pin, socket	Straight, M12, 5-pin, plug	-	380200	380201	380202	-	380203
Angled, M8, 4-pin, socket	Angled, M12, 5-pin, plug	-	380204	380205	380206	-	380207

<sup>1)</sup> An adapter is also required, order number: 380300

Features	Order number
Multiple interface PDP67, protection type IP67, PL e of EN ISO 13849-1, SIL CL 3 of EN/IEC 62061 and Cat. 4 of EN 954-1	773 600

## ► Selection guide – Cable for PSEnhinge



PSEnhinge

### PSEnhinge – Cable selection for connection to any evaluation device



PSEN cable M12-4sf

Type	Description
PSEN cable M12-4sf	Cable for connection to any evaluation device
PSEN cable M12-5sf	
PSEN cable M12-5af	

### PSEnhinge – Cable selection for connection to PDP67 F 8DI ION/PSS67



PSS67/PDP67 cable M12-5sf

Type	Description
PSS67/PDP67 cable M12-5sf M12-5sm <sup>1)</sup>	Cable for connection to PDP67 F 8DI ION/PSS67
PSS67/PDP67 cable M12-5af M12-5am <sup>1)</sup>	



PDP67 F 8DI ION

Type	Description
PDP67 F 8DI ION	Sensor junction box for decentralized periphery PNOZmulti

Features		Order number (by length)				
Connection 1	Connection 2	3 m	5 m	10 m	20 m	30 m
Straight, M12, 4-pin, socket	Open cable	630300	630301	630302	-	630296
Straight, M12, 5-pin, socket		630310	630311	630312	630298	630297
Angled, M12, 5-pin, socket		630347	630348	630349	-	630350

Features		Order number (by length)				
Connection 1	Connection 2	3 m	5 m	10 m	20 m	30 m
Straight, M12, 5-pin, socket	Straight, M12, 5-pin, plug	380208	380209	380210	380220	380211
Angled, M12, 5-pin, socket	Angled, M12, 5-pin, plug	380212	380213	380214	-	380215

<sup>1)</sup> An adapter is also required, order number: 380300

Features	Order number
Multiple interface PDP67, protection type IP67, PL e of EN ISO 13849-1, SIL CL 3 of EN/IEC 62061 and Cat. 4 of EN 954-1	773600

## ► Selection guide – Cable for PSENopt

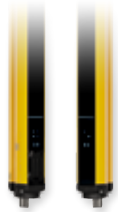

PSENopt



PSENopt

### PSENopt – Cable selection for connection to any evaluation device



PSEN op cable M12-4sf



PSEN op cable M12-5af

Type	Description
PSEN op cable M12-4sf	Cable for type 2 light grid and single-beam safety light beam devices for connection to any evaluation device
PSEN op cable M12-4af	
PSEN op cable M12-5sf	Cable for type 2 light grid, for connection to any evaluation device
PSEN op cable M12-5af	
PSEN op cable M12-4sf shielded	Cable for type 4 light grid, for connection to any evaluation device
PSEN op cable M12-4af shielded	
PSEN op cable M12-8sf shielded	
PSEN op cable M12-8af shielded	

### PSENopt – Cable selection for connection to PDP67 F 8DI ION/PSS67



PSS67/PDP67 cable M12-5sf



PDP67 F 8DI ION

Type	Description
PSS67/PDP67 cable M12-5sf M12-5sm <sup>1)</sup>	Cable for connection to PDP67 F 8DI ION/PSS67 with adapter <sup>1)</sup>
PSS67/PDP67 cable M12-5af M12-5am <sup>1)</sup>	
PDP67 F 8DI ION	Sensor junction box for decentralized periphery PNOZmulti
PDP67 F 8DI ION HP	Decentralized input module for PNOZmulti, PNOZmulti Mini

### PSENopt – Accessory selection for cascable light grids



PSEN op connector M12-5f



PSEN op cable M12-4sf

Type	Description
PSEN op connector M12-5f	M12 coupling sockets, for cascade master in standalone mode
PSEN op cable axial M12-5sf shielded	Cable for cascading
PSEN op cable M12-4sf shielded	Cable for L-Muting
PSEN op cableset M12-4sf shielded	Y-cable for T-Muting



Features		Order number (by length)					
Connection 1	Connection 2	3 m	5 m	10 m	20 m	30 m	50 m
Unshielded, straight, M12, 4-pin, socket	Open cable	630300	630301	630302	-	630296	630362
Unshielded, angled, M12, 4-pin, socket		630341	630342	630343	-	630344	630363
Unshielded, straight, M12, 5-pin, socket		630310	630311	630312	630298	630297	630364
Unshielded, angled, M12, 5-pin, socket		630347	630348	630349	-	630350	630365
Shielded, straight, M12, 4-pin, socket		630303	630304	630305	-	630309	630366
Shielded, angled, M12, 4-pin, socket		630306	630307	630308	-	630319	630367
Shielded, straight, M12, 8-pin, socket		630313	630314	630315	-	630328	630368
Shielded, angled, M12, 8-pin, socket		630316	630317	630318	-	630329	630369

Features		Order number (by length)					
Connection 1	Connection 2	2 m	3 m	5 m	10 m	20 m	30 m
Straight, M12, 5-pin, socket	Straight, M12, 5-pin, plug	-	380208	380209	380210	380220	380211
Angled, M12, 5-pin, socket	Angled, M12, 5-pin, plug	-	380212	380213	380214	-	380215

<sup>1)</sup> An adapter is also required, order number: 380326

Features	Order number
Multiple interface PDP67, protection type IP67, PL e of EN ISO 13849-1, SIL CL 3 of EN/IEC 62061 and Cat. 4 of EN 954-1	773600
Multiple interface PDP67, protection type IP67, PL e of EN ISO 13849-1, SIL CL 3 of EN/IEC 62061 and Cat. 4 of EN 954-1 High Power: Additional supply voltage	773601

Features		Order number (by length)		
Connection 1	Connection 2	0.5 m	0.75 m	1 m
M12, 5-pin, socket	-	630285	-	-
Shielded, straight, M12, 5-pin, socket	Shielded, straight, M12, 5-pin, socket	630280	-	630281
Shielded, straight, M12, 4-pin, socket	Shielded, angled, M12, 4-pin, socket	-	630282	-
Shielded, straight, M12, 4-pin, socket	2 connections: Shielded, angled, M12, 4-pin, socket	630295	-	-

## ▶ Selection guide – Cable for PSENopt Advanced



PSENopt Advanced

### PSENopt Advanced – Cable selection for connection to any evaluation device

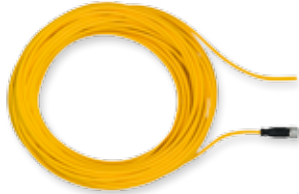

PSEN op cable M12-4sf

Type	Description
PSEN op cable axial M12 12-pole	Cable for light grid PSENopt Advanced for connection to any evaluation device

### PSENopt Advanced – Adapter and connector



PSEN op cascading



PSEN op pigtail receiver blanking

Type	Description
PSEN op Ethernet cable	Ethernet cable for PSEN op Advanced Programming Adapter

Type	Description
PSEN op cascading	Cable for cascading

Type	Description
PSEN op pigtail emitter	Connection cable, transmitter
PSEN op pigtail receiver blanking	Connection cable, receiver, blanking
PSEN op pigtail receiver muting	Connection cable, receiver, muting

Features		Order number (by length)					
Connection 1	Connection 2	3 m	5 m	10 m	20 m	30 m	50 m
Unshielded, straight, M12, 12-pin, socket	Open cable	631 080	631 081	631 082	631 083	631 084	631 085

Features		Order number (by length)		
Connection 1	Connection 2	1 m	3 m	10 m
RJ45, 4-pin	M12, 5-pin, connector	631 071	631 072	631 073

Features		Order number (by length)		
Connection 1	Connection 2	0.05 m	0.5 m	1 m
18-pin, system connector	18-pin, system connector	631 058	631 059	631 060

Features		Order number (by length)
Connection 1	Connection 2	0.2 m
18-pin, system connector	M12, 5-pin, connector	631 055
18-pin, system connector	M12, 12-pin, connector	631 056
18-pin, system connector	M12, 12 and 5-pin, connector	631 057

## ▶ Selection guide – Cable accessories for sensor



PSENcode



PSENmag



PSENmag

### Sensor technology PSEN – Accessory selection for self-assembly plugs and sockets



PSEN/PDP67 M12-8sf  
screw terminals



PSEN/PDP67 M12-8sm  
screw terminals

Type	Description
PSS67 M12 connector M12-5sf	Female connector
PSS67 M12 connector M12-5sm	Male connector
PSS67 M12 connector M12-5af	Female connector
PSS67 M12 connector M12-5am	Male connector
PSEN/PDP67 M12-8sf screw terminals	Female connector
PSEN/PDP67 M12-8sm screw terminals	Male connector

# technology PSEN®

Features		Order number
Connection 1	Connection 2	
Straight, M12, socket	Screw terminal suitable for 5-core cable, max. 0.75 mm <sup>2</sup>	380309
Straight, M12, plug		380308
Angled, M12, socket		380311
Angled, M12, plug		380310
Straight, M12, socket	Screw terminal suitable for 8-core cable, max. 0.5 mm <sup>2</sup>	540332
Straight, M12, plug		540334

## ► Selection guide – Accessories PSENrope, PSENmech,

### Accessories PSENrope



PSEN rs pulley flex



PSEN rs spring

Description Type	Features	Quantity	Order number
Block rope pulley <b>PSEN rs pulley flex</b>	Rotatable	1	570313
Rope for rope pull switch <b>PSEN rs rope d3/d4</b>	<ul style="list-style-type: none"> <li>▶ Rope diameter: 3 mm</li> <li>▶ Insulation diameter: 4 mm</li> <li>▶ PVC-coated, red</li> </ul>	1	50 m ___ 570314 100 m ___ 570315
Guide roller <b>PSEN rs pulley 75</b>	ø 75 mm	1	570312
Cage clamp <b>PSEN rs spring</b>	Steel, max. spring force to tension the rope		
	175 N	1	570310
	300 N	1	570311

### Accessories PSENmech



PSEN screw

Description Type	Features	Quantity	Order number
One-way screw to secure the actuator <b>PSEN screw M4x16</b>	<ul style="list-style-type: none"> <li>▶ Stainless steel</li> <li>▶ Drive: One-way slot (safety screw)</li> <li>▶ M4, 16 mm</li> <li>▶ Suitable for PSEN me1/1AS and PSEN me4</li> </ul>	10	540310
<b>PSEN screw M5x20</b>	<ul style="list-style-type: none"> <li>▶ M5, 20 mm</li> <li>▶ Suitable for PSEN me1/1AR, PSEN me2 and PSEN me3</li> </ul>	10	540312

### Accessories PSENcode/PSENmag



PSEN screw

Description Type	Features	Quantity	Order number
One-way screw to secure the actuator <b>PSEN screw M5x10</b>	<ul style="list-style-type: none"> <li>▶ Stainless steel</li> <li>▶ Drive: One-way slot (safety screw)</li> <li>▶ M5, 10 mm</li> <li>▶ Suitable for PSEN cs1 and PSEN cs2</li> </ul>	10	540311
<b>PSEN screw M5x20</b>	<ul style="list-style-type: none"> <li>▶ M5, 20 mm</li> <li>▶ Suitable for PSEN cs1 and PSEN cs2</li> </ul>	10	540312
End caps <b>PSEN cs3/cs4, PSEN ma1.4 actuator caps</b>	Suitable for PSEN cs3/PSEN cs4 actuator	50	540335
Mounting bracket <b>PSEN bracket</b>	Suitable for PSENmag and PSENcode	1	532110

# PSENcode, PSENmag, PSENhinge, PSENslock, PSENsgate

## Accessories PSENhinge



PSEN hs1 hinge

Description Type	Features	Quantity	Order number
Empty hinge <b>PSEN hs1 hinge</b>	Stainless steel	1	570280
Change kit <b>PSEN hs kit1</b>	To re-adjust the switching point	1	570281

## Accessories PSENslock



PSEN screw



PSEN sl restart interlock

Description Type	Features	Quantity	Order number
One-way screw to secure the actuator <b>PSEN screw M5x20</b>	<ul style="list-style-type: none"> <li>▶ Stainless steel</li> <li>▶ Drive: One-way slot (safety screw)</li> <li>▶ M5, 20 mm</li> <li>▶ Suitable for PSEN sl</li> </ul>	10	540312
Mounting bracket for sensors <b>PSEN sl bracket sliding door</b>	For sliding gates	2	570551
<b>PSEN sl bracket swing door</b>	For swing gates	1	570550
Reset lock <b>PSEN sl restart interlock (padlock)</b>	<ul style="list-style-type: none"> <li>▶ Mechanical add-on module for attachment to PSEN sl-0.5 or PSEN sl-1.0</li> <li>▶ Enables up to two padlocks or carabiners to be attached to stop the door closing and to prevent the machine from restarting</li> </ul>	1	570552

## Accessories PSENsgate



PSEN sg auxiliary release pin



PSEN sg color covers (pushbutton)

Description Type	Features	Quantity	Order number
Escape release <b>PSEN sg escape release pin</b>	-	1	570870
Auxiliary release <b>PSEN sg auxiliary release pin</b>	-	1	570871
Cover <b>PSEN sg2 cover</b>	-	1	570773
Color control elements <b>PSEN sg color covers (pushbutton)</b>	-	6	570875
Connection cable 200 m <b>PSEN cable 200m-8x0.25mm²</b>	-	1	570793



## ▶ Selection guide – Accessories PSENopt

### Accessories PSENopt – Body, hand and finger protection



PSEN op Protective Column-060/1



PSEN op Protective Base/1

Description Type	Features	Height	Order number
▶ Post protector			
PSEN op Protective Column-060/1	▶ Post protector with fixed baseplate for protection against shock, collision and vibration ▶ Light grids or deviating mirrors can be integrated ▶ Expandable with baseplate PSEN op Protective Base/1 as an option	450 mm <sup>1)</sup>	630 950
PSEN op Protective Column-090/1		750 mm <sup>1)</sup>	630 951
PSEN op Protective Column-120/1		1 050 mm <sup>1)</sup>	630 952
PSEN op Protective Column-165/1		1 500 mm <sup>1)</sup>	630 953
PSEN op Protective Column-190/1		1 800 mm <sup>1)</sup>	630 954
▶ Base plate			
PSEN op Protective Base/1	Baseplate sprung to compensate for collisions	-	630 955
▶ Fixture for post protector			
PSEN op Protective Bracket-4/1	Retaining bracket for securing a light grid in a post protector up to 105 cm	-	630 956
PSEN op Protective Bracket-6/1	Retaining bracket for securing a light grid in a post protector from 120 cm	-	630 957
PSEN op Protective Bracket Mirror/1	Fixture for mirror in a post protector (slot nut and hexagon socket screw for securing to the backplane rail)	-	630 960

<sup>1)</sup> Height of protected field for the light grid up to max.

Description Type	Features	Length	Order number
▶ Post protector including mirror			
	▶ Post protector with fixed baseplate for protection against shock, collision and vibration ▶ Expandable with baseplate PSEN op Protective Base/1 as an option		
PSEN op Protective Column 2-050/1	Includes 2 mirrors for body protection	500 mm	630 961
PSEN op Protective Column 3-080/1	Includes 3 mirrors for body protection	800 mm	630 962
PSEN op Protective Column 4-090/1	Includes 4 mirrors for body protection	900 mm	630 963
PSEN op Protective Column 4-120/1	Includes 4 mirrors for body protection	1 200 mm	630 964
▶ Deviating mirror <sup>2)</sup>			
PSEN op Mirror-015/1	Deviating mirror	150 mm <sup>2)</sup>	630 900
PSEN op Mirror-060/1	Deviating mirror	600 mm <sup>2)</sup>	630 901
PSEN op Mirror-090/1	Deviating mirror	900 mm <sup>2)</sup>	630 902
PSEN op Mirror-120/1	Deviating mirror	1 200 mm <sup>2)</sup>	630 903
PSEN op Mirror-165/1	Deviating mirror	1 650 mm <sup>2)</sup>	630 904
PSEN op Mirror-190/1	Deviating mirror	1 900 mm <sup>2)</sup>	630 905
▶ Bracket			
PSEN op Mirror Bracket Kit/1	Bracket for stand-alone assembly (2-part aluminium baseplate for flexible attachment, angle can be adjusted around vertical axis)	-	630 906

<sup>2)</sup> The length of the deviating mirror must be at least 100 mm greater than the height of the protected field of the light grid itself.



PSEN op Mirror-060/1

## Accessories PSENopt – Body, hand and finger protection



Description Type	Features	Length	Order number
<b>► Protective housing<sup>1)</sup> for light grid .../1 (new generation)</b>			
PSEN op67-69K-015/1	Hand and finger protection	150 mm	630 930
PSEN op67-69K-030/1	Hand and finger protection	300 mm	630 931
PSEN op67-69K-045/1	Hand and finger protection	450 mm	630 932
PSEN op67-69K-060/1	Hand and finger protection	600 mm	630 933
PSEN op67-69K-075/1	Hand and finger protection	750 mm	630 934
PSEN op67-69K-090/1	Hand and finger protection	900 mm	630 935
PSEN op67-69K-105/1	Hand and finger protection	1 050 mm	630 936
PSEN op67-69K-120/1	Hand and finger protection	1 200 mm	630 937
PSEN op67-69K-135/1	Hand and finger protection	1 350 mm	630 938
PSEN op67-69K-150/1	Hand and finger protection	1 500 mm	630 939
PSEN op67-69K-165/1	Hand and finger protection	1 650 mm	630 940
PSEN op67-69K-180/1	Hand and finger protection	1 800 mm	630 941
<b>► Protective housing<sup>1)</sup> for light grid</b>			
PSEN op67-69K-2-050	Body protection	500 mm	630 942
PSEN op67-69K-3-080	Body protection	800 mm	630 943
PSEN op67-69K-4-090	Body protection	900 mm	630 944
PSEN op67-69K-4-120	Body protection	1 200 mm	630 945
<b>► Front protection/protective shield for light grid.../1 (new generation)</b>			
PSEN op Lens Shield-015/1	Hand and finger protection	150 mm	630 910
PSEN op Lens Shield-030/1	Hand and finger protection	300 mm	630 911
PSEN op Lens Shield-045/1	Hand and finger protection	450 mm	630 912
PSEN op Lens Shield-060/1	Hand and finger protection	600 mm	630 913
PSEN op Lens Shield-075/1	Hand and finger protection	750 mm	630 914
PSEN op Lens Shield-090/1	Hand and finger protection	900 mm	630 915
PSEN op Lens Shield-105/1	Hand and finger protection	1 050 mm	630 916
PSEN op Lens Shield-120/1	Hand and finger protection	1 200 mm	630 917
PSEN op Lens Shield-135/1	Hand and finger protection	1 350 mm	630 918
PSEN op Lens Shield-150/1	Hand and finger protection	1 500 mm	630 919
PSEN op Lens Shield-165/1	Hand and finger protection	1 650 mm	630 920
PSEN op Lens Shield-180/1	Hand and finger protection	1 800 mm	630 921
<b>► Front protection/protective shield for light grid</b>			
PSEN op Lens Shield-2-050	Body protection	500 mm	630 922
PSEN op Lens Shield-3-080	Body protection	800 mm	630 923
PSEN op Lens Shield-4-090	Body protection	900 mm	630 924
PSEN op Lens Shield-4-120	Body protection	1 200 mm	630 925

<sup>1)</sup> Application: one light grid per protective housing

## ▶ Selection guide – Accessories PSENopt

### Accessories PSENopt – Body, hand and finger protection



PSEN op bracket turnable (kit)



PSEN op Testpiece



Laser pointer for PSEN 4/2

Description Type	Features	Quantity	Order number
Mounting bracket <b>PSEN op Bracket</b>	Suitable for muting sensors	1	630 324
<b>PSEN op Bracket kit</b>	<ul style="list-style-type: none"> <li>▶ Suitable for all PSENopt except PSEN op2H</li> <li>▶ Profile: 30 x 30 mm</li> </ul>	4	630 325 <sup>1)</sup>
<b>PSEN op Bracket kit adjustable</b>	<ul style="list-style-type: none"> <li>▶ Adjustable</li> <li>▶ Profile: 30 x 30 mm</li> </ul>	4	630 326
<b>PSEN op Bracket kit antivibration</b>	<ul style="list-style-type: none"> <li>▶ Vibration-resistant</li> <li>▶ Profile: 30 x 30 mm</li> </ul>	4	630 327
<b>PSEN op bracket turnable (kit)</b>	<ul style="list-style-type: none"> <li>▶ Suitable for PSEN op.../1, rotatable and adjustable</li> <li>▶ Profile: 30 x 30 mm</li> </ul>	4	630 772 <sup>2)</sup>
Test rods	For regular function test		
<b>PSEN op Testpiece F 14 mm</b>	Finger protection, ø 14 mm	1	630 345
<b>PSEN op Testpiece H 30mm</b>	Hand protection, ø 30 mm	1	630 346
Alignment guide <b>Laser pointer for PSEN 4/2</b>	Laser protection class 2 in accordance with EN 60825-1	1	630 340

<sup>1)</sup> Included with the PSENopt

<sup>2)</sup> Included with the PSEN op.../1

### Accessories PSENopt Advanced – Hand and finger protection



PSEN op Advanced Programming Adapter

Description Type	Features	Quantity	Order number
Mounting bracket <b>PSEN op cascading bracket</b>	Corner fixture for two light grids	1	631 061
Adapter <b>PSEN op Advanced Programming Adapter</b>	Programming adapter for PSENopt Configurator <sup>3)</sup>	1	631 070

<sup>3)</sup> To use the software the adapter must be ordered.

**Accessories PSENopt – Single-beam safety light beam devices**

Description Type	Features	Quantity	Order number
Deviating mirror <b>PSEN 2S/4S mirror</b>	Suitable for light beam devices PSEN op2S/4S	1	630711
Mounting bracket <b>PSEN 2S/4S bracket</b>	Suitable for light beam devices PSEN op2S/4S	2	630712

**Accessories PSENopt – Muting**



PIT si 1.1

Description Type	Features	Quantity	Order number
Signal lamp for muting mode  <b>PIT si 1.1</b>	<ul style="list-style-type: none"> <li>▶ Operating range: 0.1 ... 3 m</li> <li>▶ Protection type: IP65</li> <li>▶ Supply voltage: 24 VDC</li> <li>▶ Unmonitored in accordance with EN/IEC 61496-1</li> <li>▶ Incl. incandescent lamp, mounting bracket and 2 screws</li> </ul>	1	620010
<b>PIT si 1.2</b>	<ul style="list-style-type: none"> <li>▶ Monitored in accordance with EN/IEC 61496-1 and VDE 0113-201</li> <li>▶ 2 semiconductor outputs to monitor the function of the filament</li> <li>▶ TÜV approval</li> </ul>	1	620020
<b>PIT si 2.1</b>	<ul style="list-style-type: none"> <li>▶ Unmonitored in accordance with EN/IEC 61496-1 and VDE 0113-201</li> <li>▶ TÜV approval</li> <li>▶ Incl. LED, mounting bracket and 2 screws</li> <li>▶ Service life up to 50000 hours</li> </ul>	1	620015

## ▶ Selection guide – PSENopt and PSEnvip

### Accessories PSENopt – Muting



PSEN op1.1



PSEN op2.1  
L-Muting Set



PSEN op2.4  
L-Reflector



PSEN op muting  
bracket kit

Description Type	Features	Quantity	Order number
Muting sensors	<ul style="list-style-type: none"> <li>▶ Output: PNP, N/O and N/C</li> <li>▶ Supply voltage: 10 ... 30 VDC</li> <li>▶ Connection: Male connector, M12, 4-pin</li> </ul>		
<b>PSEN op1.2 Emitter M12</b>	Transmitter: <ul style="list-style-type: none"> <li>▶ Suitable for PSEN op4, PSEN op2B</li> <li>▶ Operating range: 0 ... 20 m</li> </ul>	1	630 322
<b>PSEN op1.1 Receiver pnp no/nc M12</b>	Receiver: <ul style="list-style-type: none"> <li>▶ Suitable for PSEN op4, PSEN op2B</li> <li>▶ Operating range: 0 ... 20 m</li> </ul>	1	630 321
<b>PSEN op1.3 Reflex pnp no/nc M12</b>	Reflex: <ul style="list-style-type: none"> <li>▶ Suitable for PSEN op2B, PSEN op4, PSEN opSB</li> <li>▶ With prism reflector</li> <li>▶ Operating range: 0.1 ... 6 m</li> </ul>	1	630 320
<b>PSEN op Reflector</b>	Reflector: <ul style="list-style-type: none"> <li>▶ Suitable for PSEN op2B, PSEN op4, PSEN opSB</li> <li>▶ With prism reflector</li> <li>▶ Operating range: 0.1 ... 6 m</li> </ul>	1	630 323
Muting sets			
<b>PSEN op2.1 L-Muting Set</b>	Complete muting set for L-Muting, incl. cable and bracket	1	630 820
<b>PSEN op2.2 T-Muting Set</b>	Complete muting set for T-Muting, incl. cable and bracket	1	630 821
Muting arms			
<b>PSEN op2.3 L-Reflex</b>	Single muting arm, active (transmitter/receiver)	1	630 822
<b>PSEN op2.4 L-Reflector</b>	Single muting arm, passive (reflector)	1	630 823
Mounting profile <b>PSEN op muting bracket kit</b>	Mounting profile for assembling the integrated muting arms on a suitable light grid	1	630 824

Accessories PSEnvip



PSEnvip MS



PSEnvip AT mag



PSEnvip TP

Description Type	Features	Quantity	Order number
Adapter plate <b>PSEnvip MB</b>	To mount the PSEnvip AP on to any bracket, with slot	2	583205
Retaining brackets <b>PSEnvip MS</b>	Retaining brackets (set) for installation	2	583206
Adjustment plates <b>PSEnvip AP</b>	For PSEnvip, transmitter and receiver	2	583202 <sup>1)</sup>
Adjustment templates <b>PSEnvip AT mag</b>	With magnet to align PSEnvip on a first-time installation	2	583203 <sup>1)</sup>
<b>PSEnvip AT mech</b>	For mechanical installation in the tool holder on a first-time installation	2	583204
Test piece <b>PSEnvip TP</b>	For regular function test, finger protection	1	583200 <sup>1)</sup>

<sup>1)</sup> Included with the PSEnvip (Set)

## ▶ Selection guide – Accessories for SafetyEYE®

### Accessories for SafetyEYE

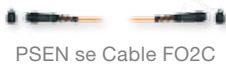

PSEN se Cable FO2C



PSEN se SM 10/  
PSEN se RM 10



SafetyEYE  
Configurator



PIT si3.1



PSEN se PA 250



CFast Card

Description Type	Features	Quantity	Order number
Cable for data and supply voltage <b>PSEN se Cable FO2C ...</b>	To connect the sensing device to the analysis unit: FOC for data, copper cables for 12 V supply voltage	1	▶ 15 m __ 581 122 ▶ 30 m __ 581 123 <sup>1)</sup> ▶ 50 m __ 581 124 ▶ 80 m __ 581 125
Cable for data and supply voltage <b>PSEN se Cable FO2C ... UL</b>	Like PSEN se Cable FO2C with UL approval	1	▶ 15 m __ 581 126 ▶ 30 m __ 581 127 ▶ 50 m __ 581 128 ▶ 80 m __ 581 129
Ethernet connection cable <b>PSEN se Cable ETH Patch</b>	To connect the analysis unit to the programmable control system or configuration PC, shielded	1	▶ 1 m __ 581 112 <sup>2)</sup> ▶ 5 m __ 581 111 <sup>1)</sup>
Setup markers <b>PSEN se SM 6</b> <b>PSEN se SM 10</b>	Depends on the distance between sensing device and user plane 1 ... 6 m 4 ... 10 m	5 5	581 160 <sup>3)</sup> 581 161 <sup>3)</sup>
Reference markers <b>PSEN se RM 6</b> <b>PSEN se RM 10</b>	Depends on the distance between sensing device and user plane 1 ... 5 m 4 ... 9 m	6 6	581 170 <sup>3)</sup> 581 171 <sup>3)</sup>
Software <b>SafetyEYE Configurator CD + Handbook</b>	CD containing configuration software for SafetyEYE Assistant and Configurator, plus SafetyEYE documentation	1	581 250
<b>SafetyEYE Configurator Base License</b>	Basic license for the SafetyEYE Assistant and Configurator	1	581 250B
<b>SafetyEYE Configurator CD</b>	CD with configuration software SafetyEYE Assistant and Configurator	1	581 250D <sup>3)</sup>
<b>SafetyEYE Configurator Base License</b>	Copy license for the SafetyEYE Assistant and Configurator	1	581 250K
Indicator Light Unit <b>PIT si3.1 indicator light unit</b>	▶ Red, amber, green ▶ Supply voltage +24 VDC	1	581 190 <sup>3)</sup>
Test piece <b>PSEN se TO Body 140</b>	For regular function test, body protection, ø 140 mm	1	581 182 <sup>3)</sup>
Swivel arm <b>PSEN se PA 250</b>	For installing the sensing device	1	581 150 <sup>3)</sup>
Mounting bracket <b>PSEN se AU AM2 Rear Mount</b>	▶ Suitable for mounting plate for the analysis unit (2 <sup>nd</sup> generation) ▶ Dimensions (H x W x D): 250 x 30 x 55 mm	1	581 201 <sup>3)</sup>
CFast Card <b>CFast Card</b>	For storing the project, 4 GByte memory capacity	1	310389 <sup>3)</sup> 4)
Screw connector <b>PSS ZKL 3047-3</b> <b>PSS ZKL 3075-3</b>	Plug-in screw terminals (1 set) For PSS 3047-3 ETH-2 SE For PSS SB 3075-3 ETH-2 SE	1 1	300900 <sup>3)</sup> 300910

<sup>1)</sup> 1 cables included in the SafetyEYE Starter Set (2nd generation)

<sup>2)</sup> 2 cables included in the SafetyEYE Starter Set (2nd generation)

<sup>3)</sup> Included in the SafetyEYE Starter Set

<sup>4)</sup> 2 cards included when ordering an analysis unit

# Index PSEN®

## ► A

Absolute encoder \_\_\_\_\_ 16, 17  
 Accessories \_\_\_\_\_ 94-118  
 ATEX \_\_\_\_\_ 24, 27, 29, 30, 33

## ► B

Base version \_\_\_\_\_ 68, 69, 70, 71  
 Bending angle measurement \_\_\_\_\_ 68, 71  
 Blanking \_\_\_\_\_ 52, 53, 54, 56, 57, 64, 66, 106

## ► C

Camera system \_\_\_\_\_ 9, 11, 72, 73, 74, 75, 94  
 Cascading \_\_\_\_\_ 52, 53, 54, 56, 57, 64, 65, 66, 67, 93, 104, 106  
 Category \_\_\_\_\_ 24, 25, 38, 44, 48  
 Coded safety switch \_\_\_\_\_ 9, 18, 19, 30, 31, 32, 33, 34, 35, 36, 37

## ► D

Decentralized modules PDP67 \_\_\_\_\_ 92, 93  
 Diagnostics \_\_\_\_\_ 13, 25, 34, 35, 45, 52, 53, 56, 57, 93

## ► E

Emergency stop \_\_\_\_\_ 9, 14, 15, 43, 48, 49, 50, 72, 76, 77, 78, 79, 80, 81, 82, 83  
 EN/IEC 61496-1/-2 \_\_\_\_\_ 52, 53, 54, 58, 59, 60, 62, 64, 66, 71, 73, 74, 115  
 EN/IEC 61508 \_\_\_\_\_ 58, 60, 62, 64, 66, 71, 73, 74  
 EN/IEC 62061 \_\_\_\_\_ 11, 13, 15, 22, 26, 28, 32, 38, 41, 43, 46, 50, 53, 58, 60, 62, 64, 66, 76, 82, 87, 93, 97, 99, 101, 103, 105  
 EN 12622 \_\_\_\_\_ 69, 71  
 EN 60947-5-3 \_\_\_\_\_ 22, 24, 26, 28, 30, 41, 46, 50  
 Enabling switch \_\_\_\_\_ 43, 49, 88, 90, 91  
 Energy efficiency \_\_\_\_\_ 32, 33, 45, 46, 47, 49, 50, 51  
 EN ISO 13849-1 \_\_\_\_\_ 11, 13, 15, 22, 26, 28, 32, 35, 38, 41, 43, 46, 50, 53, 58, 60, 62, 64, 66, 71, 73, 74, 76, 82, 87, 93, 97, 99, 101, 103, 105  
 EN ISO 14119 \_\_\_\_\_ 18, 19, 20, 24, 42  
 EN ISO 9001 \_\_\_\_\_ 11  
 Escape release \_\_\_\_\_ 38, 39, 43, 48, 50, 111

## ► F

Fully-coded \_\_\_\_\_ 19, 30, 32, 44, 46

## ► G

Guard locking \_\_\_\_\_ 8, 18, 19, 20, 22, 38, 42, 43, 45, 46, 48, 49

## ► H

Hinge switch, safe \_\_\_\_\_ 9, 19, 40, 41  
 Hygiene regulations \_\_\_\_\_ 24, 25, 31

## ► I

IP67 \_\_\_\_\_ 15, 19, 22, 25, 26, 28, 31, 32, 36, 40, 41, 46, 92, 97, 99, 101, 103, 105  
 IP6K9K \_\_\_\_\_ 19, 25, 26, 31, 32, 54, 76, 77, 80, 81

## ► K

Key lock principle \_\_\_\_\_ 24, 30

## ► L

Light beam devices \_\_\_\_\_ 9, 11, 52, 54, 56, 58, 60, 62, 64, 66, 94, 104, 115

## ► M

Machine lifecycle \_\_\_\_\_ 120  
 Magnetic safety switch \_\_\_\_\_ 9, 18, 19, 24, 25, 26, 27, 28, 29  
 Manipulation protection \_\_\_\_\_ 8, 9, 18, 24, 25, 26, 30, 31, 38, 40, 43, 44, 45, 73, 85, 91  
 Manually operated command device \_\_\_\_\_ 88, 89, 90  
 Mechanical safety switch \_\_\_\_\_ 9, 18, 19, 20, 21, 22, 23, 38  
 Muting \_\_\_\_\_ 52, 53, 54, 55, 56, 57, 58, 59, 64, 66, 70, 104, 106, 114, 115, 116

## ► O

Operating mode selector switch \_\_\_\_\_ 84, 85  
 OSSD \_\_\_\_\_ 32, 34, 35, 36, 37

## ► P

Passive junction \_\_\_\_\_ 46, 92, 93, 96  
 PDP20 \_\_\_\_\_ 26, 28, 92, 93  
 PITenable \_\_\_\_\_ 90, 91  
 PITestop \_\_\_\_\_ 76, 78, 80, 82  
 PITjog \_\_\_\_\_ 88, 89  
 PITmode \_\_\_\_\_ 84, 85, 86, 87  
 PNOZmulti 2 \_\_\_\_\_ 45, 49, 84, 85  
 PNOZmulti \_\_\_\_\_ 25, 52, 58, 69, 84, 87, 88, 91, 92, 93, 95, 98, 100, 101, 102, 104  
 PNOZmulti Mini \_\_\_\_\_ 35, 83, 84, 92, 93, 104  
 PNOZsigma \_\_\_\_\_ 13, 15, 21, 31, 39, 41, 55, 92, 93, 101  
 Position monitoring \_\_\_\_\_ 8, 9, 11, 13, 18, 22, 24, 26, 28, 30, 32, 34, 35, 36, 37, 41, 43, 46, 50, 94  
 Press brakes \_\_\_\_\_ 9, 69, 70  
 Presses \_\_\_\_\_ 9, 17, 68, 69  
 Process guarding \_\_\_\_\_ 42, 43, 44  
 Productive version \_\_\_\_\_ 68, 70, 71  
 Programmable control system \_\_\_\_\_ 58, 73, 74, 84, 88, 118  
 Protection against defeat \_\_\_\_\_ 39  
 PSEnbolt \_\_\_\_\_ 9, 18, 19, 38, 39  
 PSEN cable \_\_\_\_\_ 13, 25, 31, 35, 39, 41, 45, 55, 94, 96, 100, 102, 111

PSENcode \_\_\_\_\_ 8, 9, 12, 13, 18, 19, 24, 30, 32, 34, 36, 38, 39, 43, 46, 48, 50, 92, 93, 94, 96, 98, 108, 110  
 PSENNenco \_\_\_\_\_ 16, 17  
 PSENhinge \_\_\_\_\_ 9, 18, 19, 40, 41, 92, 95, 102, 111  
 PSENNini \_\_\_\_\_ 9, 12, 13, 31, 32, 43, 46, 48, 50, 92, 94, 96, 48  
 PSENNmag \_\_\_\_\_ 9, 18, 19, 24, 25, 26, 28, 92, 93, 95, 100, 108, 110  
 PSENmech \_\_\_\_\_ 9, 18, 19, 20, 21, 22, 38, 92, 95, 98, 110  
 PSENopt \_\_\_\_\_ 9, 52, 53, 54, 55, 56, 58, 60, 62, 93, 95, 104, 112, 114, 116  
 PSENopt Advanced \_\_\_\_\_ 9, 56, 57, 64, 66, 106, 114  
 PSENNrope \_\_\_\_\_ 14, 15, 95, 98, 110  
 PSENNsgate \_\_\_\_\_ 9, 12, 31, 32, 42, 43, 48, 49, 50, 111  
 PSENNslock \_\_\_\_\_ 9, 12, 13, 31, 32, 42, 43, 44, 45, 46, 48, 50, 92, 93, 94, 96, 98, 111  
 PSENNvip \_\_\_\_\_ 9, 68, 69, 70, 71, 117  
 PSS 4000 \_\_\_\_\_ 16, 17, 70, 71, 84, 87, 88, 91, 92  
 PSS \_\_\_\_\_ 58, 73, 74, 84, 87, 88, 91, 93, 101, 118  
 Push-in technology \_\_\_\_\_ 77

## ► R

RFID technology \_\_\_\_\_ 8, 24, 30, 36, 39, 44, 48, 87  
 Risk assessment \_\_\_\_\_ 120  
 Rotary cam arrangement \_\_\_\_\_ 16, 17  
 Rotary encoder \_\_\_\_\_ 16, 17

## ► S

Safety bolt \_\_\_\_\_ 9, 19, 38, 39  
 SafetyBUS p \_\_\_\_\_ 74  
 Safety concept \_\_\_\_\_ 120  
 SafetyEYE \_\_\_\_\_ 9, 72, 73, 74, 118  
 Safety gate monitoring \_\_\_\_\_ 20, 38, 42, 44, 45, 48  
 Safety requirement \_\_\_\_\_ 8, 12, 18, 21, 41, 45  
 Semiconductor outputs \_\_\_\_\_ 30, 44, 52, 54, 58, 60, 62, 64, 66, 83, 115  
 Series connection \_\_\_\_\_ 12, 13, 24, 27, 29, 30, 31, 32, 33, 43, 44, 46, 50, 83, 93, 96, 100  
 Services \_\_\_\_\_ 120  
 Standard actuator \_\_\_\_\_ 21

## ► T

Three-dimensional \_\_\_\_\_ 9, 72, 73

## ► U

Unique, fully coded \_\_\_\_\_ 18, 19, 30, 32, 43, 44, 46, 50

## ► Z

Zone monitoring \_\_\_\_\_ 9, 72



## ► Consulting, engineering and training

As a solution supplier, Pilz can help you to apply optimum safety strategies worldwide. Services encompass the whole machine lifecycle. Our training package with practical, up-to-date course content completes the offering.



### We are your reliable service provider for plant and machinery safety

Your projects belong in our safe hands!



#### Risk assessment

We inspect your machinery in accordance with the applicable national and/or international standards and directives and assess the existing hazards.



#### Safety concept

We develop detailed technical solutions for the safety of your plant and machinery through mechanical, electronic and organizational measures.



#### Safety design

The aim of the safety design is to reduce or eliminate danger points through detailed planning of the necessary safeguards.



#### System implementation

The results of the risk analysis and safety design are implemented to suit the particular requirements through selected safety measures.



Our management system was certified in the field of system integration to EN/IEC 61508.

Services related to machinery safety:

 Webcode 7792

Online information at [www.pilz.com](http://www.pilz.com)



#### Safety validation

In the safety validation, the risk assessment and safety concept are mirrored and inspected by competent, specialist staff.



#### CE marking

We control all activities and processes for the necessary conformity assessment procedure, including the technical documentation that is required.



### International compliance services

We conduct the evaluation process and develop the necessary strategies in order to enable compliance with the relevant ISO, IEC, ANSI, EN or other national or international standards.



### Plant assessment

We will prepare an overview of your entire plant in the shortest possible time. With an on-site inspection we will expose risks and calculate the cost of optimizing your safeguards.



### Inspection of safeguards

With our independent, ISO 17020-compliant inspection body, which is accredited by the German Accreditation Body (DAkkS), we can guarantee objectivity and high availability of your machines.



Pilz GmbH & Co. KG, Ostfildern operates an inspection body for plant and machinery, accredited by DAkkS.



### LOTO System

Our customised Lock Out Tag Out (LOTO) measures guarantee that staff can safely control potentially hazardous energies during maintenance and repair.



### Training

Pilz offers two types of courses: Product-neutral seminars on machinery safety and product-specific courses



Knowledge is a competitive edge – Pilz training courses:

Webcode 0218

Online information at [www.pilz.com](http://www.pilz.com)



And to progress to the expert level in machinery safety we offer the qualification of CMSE® – Certified Machinery Safety Expert.

# Contact

## AT

Pilz Ges.m.b.H.  
Sichere Automation  
Modecenterstraße 14  
1030 Wien  
Austria  
Telephone: +43 1 7986263-0  
Telefax: +43 1 7986264  
E-Mail: [pilz@pilz.at](mailto:pilz@pilz.at)  
Internet: [www.pilz.at](http://www.pilz.at)

## AU

Pilz Australia  
Safe Automation  
Unit D7, Hallmarc Business park Clayton  
Corner of Westall and Centre roads  
Clayton, Melbourne, Victoria 3168  
Australia  
Telephone: +61 3 95446300  
Telefax: +61 3 95446311  
E-Mail: [safety@pilz.com.au](mailto:safety@pilz.com.au)  
Internet: [www.pilz.com.au](http://www.pilz.com.au)

## BE, LU

Pilz Belgium  
Safe Automation  
Bijenstraat 4  
9051 Gent (Sint-Denijs-Westrem)  
Belgium  
Telephone: +32 9 3217570  
Telefax: +32 9 3217571  
E-Mail: [info@pilz.be](mailto:info@pilz.be)  
Internet: [www.pilz.be](http://www.pilz.be)

## BR

Pilz do Brasil  
Automação Segura  
Av. Senador Vergueiro,  
347/355 -Jd. do Mar  
CEP: 09750-000  
São Bernardo do Campo - SP  
Brazil  
Telephone: +55 11 4126-7290  
Telefax: +55 11 4942-7002  
E-Mail: [pilz@pilz.com.br](mailto:pilz@pilz.com.br)  
Internet: [www.pilz.com.br](http://www.pilz.com.br)

## CA

Pilz Automation Safety Canada L.P.  
250 Bayview Drive  
Barrie, Ontario  
Canada, L4N 4Y8  
Telephone: +1 705 481-7459  
Telefax: +1 705 481-7469  
E-Mail: [info@pilz.ca](mailto:info@pilz.ca)  
Internet: [www.pilz.ca](http://www.pilz.ca)

## CH

Pilz Industrieelektronik GmbH  
Gewerbepark Hintermättli  
5506 Mägenwil  
Switzerland  
Telephone: +41 62 88979-30  
Telefax: +41 62 88979-40  
E-Mail: [pilz@pilz.ch](mailto:pilz@pilz.ch)  
Internet: [www.pilz.ch](http://www.pilz.ch)

## CN

Pilz Industrial Automation  
Trading (Shanghai) Co., Ltd.  
Rm. 1702-1704  
Yongda International Tower  
No. 2277 Long Yang Road  
Shanghai 201204  
China  
Telephone: +86 21 60880878  
Telefax: +86 21 60880870  
E-Mail: [sales@pilz.com.cn](mailto:sales@pilz.com.cn)  
Internet: [www.pilz.com.cn](http://www.pilz.com.cn)

## CZ, SK

Pilz Czech s.r.o.  
Safe Automation  
Zelený pruh 1560/99  
140 00 Praha 4  
Czech Republic  
Telephone: +420 222 135353  
Telefax: +420 296 374788  
E-Mail: [info@pilz.cz](mailto:info@pilz.cz)  
Internet: [www.pilz.cz](http://www.pilz.cz)

## DE

Pilz GmbH & Co. KG  
Felix-Wankel-Straße 2  
73760 Ostfildern  
Germany  
Telephone: +49 711 3409-0  
Telefax: +49 711 3409-133  
E-Mail: [info@pilz.de](mailto:info@pilz.de)  
Internet: [www.pilz.de](http://www.pilz.de)

## DK

Pilz Skandinavien K/S  
Safe Automation  
Ellegaardvej 25 L  
6400 Sønderborg  
Denmark  
Telephone: +45 74436332  
Telefax: +45 74436342  
E-Mail: [pilz@pilz.dk](mailto:pilz@pilz.dk)  
Internet: [www.pilz.dk](http://www.pilz.dk)

## ES

Pilz Industrieelektronik S.L.  
Safe Automation  
Camí Ral, 130  
Polígono Industrial Palou Nord  
08401 Granollers  
Spain  
Telephone: +34 938497433  
Telefax: +34 938497544  
E-Mail: [pilz@pilz.es](mailto:pilz@pilz.es)  
Internet: [www.pilz.es](http://www.pilz.es)

## FI

Pilz Skandinavien K/S  
Safe Automation  
Nuijamiestentie 7  
00400 Helsinki  
Finland  
Telephone: +358 10 3224030  
Telefax: +358 9 27093709  
E-Mail: [pilz.fi@pilz.dk](mailto:pilz.fi@pilz.dk)  
Internet: [www.pilz.fi](http://www.pilz.fi)

## FR

Pilz France Electronic  
1, rue Jacob Mayer  
CS 80012  
67037 Strasbourg Cedex 2  
France  
Telephone: +33 3 88104000  
Telefax: +33 3 88108000  
E-Mail: [siege@pilz-france.fr](mailto:siege@pilz-france.fr)  
Internet: [www.pilz.fr](http://www.pilz.fr)

## GB

Pilz Automation Ltd  
Pilz House  
Little Colliers Field  
Corby, Northants  
NN18 8TJ  
United Kingdom  
Telephone: +44 1536 460766  
Telefax: +44 1536 460866  
E-Mail: [sales@pilz.co.uk](mailto:sales@pilz.co.uk)  
Internet: [www.pilz.co.uk](http://www.pilz.co.uk)

## IE

Pilz Ireland Industrial Automation  
Cork Business and Technology Park  
Model Farm Road  
Cork  
Ireland  
Telephone: +353 21 4346535  
Telefax: +353 21 4804994  
E-Mail: [sales@pilz.ie](mailto:sales@pilz.ie)  
Internet: [www.pilz.ie](http://www.pilz.ie)

# Contact

## IN

Pilz India Pvt Ltd.  
Office No 202, Delite Square  
Near Aranyeshwar Temple  
Sahakar Nagar No 1  
Pune 411009  
India  
Telephone: +91 20 2421399-4/-5  
Telefax: +91 20 2421399-6  
E-Mail: [info@pilz.in](mailto:info@pilz.in)  
Internet: [www.pilz.in](http://www.pilz.in)

## IT

Pilz Italia S.r.l.  
Automazione sicura  
Via Gran Sasso n. 1  
20823 Lentate sul Seveso (MB)  
Italy  
Telephone: +39 0362 1826711  
Telefax: +39 0362 1826755  
E-Mail: [info@pilz.it](mailto:info@pilz.it)  
Internet: [www.pilz.it](http://www.pilz.it)

## JP

Pilz Japan Co., Ltd.  
Safe Automation  
Ichigo Shin-Yokohama Bldg. 4F  
3-17-5 Shin-Yokohama  
Kohoku-ku  
222-0033 Yokohama  
Japan  
Telephone: +81 45 471-2281  
Telefax: +81 45 471-2283  
E-Mail: [pilz@pilz.co.jp](mailto:pilz@pilz.co.jp)  
Internet: [www.pilz.jp](http://www.pilz.jp)

## KR

Pilz Korea Ltd.  
Safe Automation  
22F Keumkang  
Pentierum IT Tower Unit B  
810 Gwanyang-dong, Dongan-gu  
Anyang-si, Gyeonggi-do, 431-060  
South Korea  
Telephone: +82 31 450 0677  
Telefax: +82 31 450 0670  
E-Mail: [info@pilzkorea.co.kr](mailto:info@pilzkorea.co.kr)  
Internet: [www.pilz.co.kr](http://www.pilz.co.kr)

## MX

Pilz de México, S. de R.L. de C.V.  
Automatización Segura  
Convento de Actopan 36  
Jardines de Santa Mónica  
Tlalnepantla, Méx. 54050  
Mexico  
Telephone: +52 55 5572 1300  
Telefax: +52 55 5572 1300  
E-Mail: [info@pilz.com.mx](mailto:info@pilz.com.mx)  
Internet: [www.pilz.mx](http://www.pilz.mx)

## NL

Pilz Nederland  
Veilige automatisering  
Havenweg 22  
4131 NM Vianen  
Netherlands  
Telephone: +31 347 320477  
Telefax: +31 347 320485  
E-Mail: [info@pilz.nl](mailto:info@pilz.nl)  
Internet: [www.pilz.nl](http://www.pilz.nl)

## NZ

Pilz New Zealand  
Safe Automation  
Unit 4, 12 Laidlaw Way  
East Tamaki  
Auckland 2016  
New Zealand  
Telephone: +64 9 6345350  
Telefax: +64 9 6345352  
E-Mail: [office@pilz.co.nz](mailto:office@pilz.co.nz)  
Internet: [www.pilz.co.nz](http://www.pilz.co.nz)

## PL

Pilz Polska Sp. z o.o.  
Safe Automation  
ul. Ruchliwa 15  
02-182 Warszawa  
Poland  
Telephone: +48 22 8847100  
Telefax: +48 22 8847109  
E-Mail: [info@pilz.pl](mailto:info@pilz.pl)  
Internet: [www.pilz.pl](http://www.pilz.pl)

## PT

Pilz Industrieelektronik S.L.  
R. Eng Duarte Pacheco, 120  
4 Andar Sala 21  
4470-174 Maia  
Portugal  
Telephone: +351 229407594  
Telefax: +351 229407595  
E-Mail: [pilz@pilz.pt](mailto:pilz@pilz.pt)  
Internet: [www.pilz.pt](http://www.pilz.pt)

## RU

Pilz RUS OOO  
Ugreshskaya street, 2,  
bldg. 11, office 16 (1st floor)  
115088 Moskau  
Russian Federation  
Telephone: +7 495 665 4993  
E-Mail: [pilz@pilzrussia.ru](mailto:pilz@pilzrussia.ru)  
Internet: [www.pilzrussia.ru](http://www.pilzrussia.ru)

## SE

Pilz Skandinavien K/S  
Safe Automation  
Energigatan 10 B  
43437 Kungsbacka  
Sweden  
Telephone: +46 300 13990  
Telefax: +46 300 30740  
E-Mail: [pilz.se@pilz.dk](mailto:pilz.se@pilz.dk)  
Internet: [www.pilz.se](http://www.pilz.se)

## TR

Pilz Emniyet Otomasyon  
Ürünleri ve Hizmetleri Tic. Ltd. Şti.  
Kayışdağı Mahallesi Dudullu Yolu Cad.  
Mechun Sok. Duru Plaza No:7  
34755 Ataşehir/İstanbul  
Turkey  
Telephone: +90 216 5775550  
Telefax: +90 216 5775549  
E-Mail: [info@pilz.com.tr](mailto:info@pilz.com.tr)  
Internet: [www.pilz.com.tr](http://www.pilz.com.tr)

## TW

Pilz Taiwan Ltd.  
7F.-3, No. 146, Songjiang Rd.  
Zhongshan Dist., Taipei City  
104, Taiwan  
Telephone: +886 2 2568 1680  
Telefax: +886 2 2568 1600  
E-Mail: [info@pilz.tw](mailto:info@pilz.tw)  
Internet: [www.pilz.tw](http://www.pilz.tw)

## US

Pilz Automation Safety L.P.  
7150 Commerce Boulevard  
Canton  
Michigan 48187  
USA  
Telephone: +1 734 354 0272  
Telefax: +1 734 354 3355  
E-Mail: [info@pilzusa.com](mailto:info@pilzusa.com)  
Internet: [www.pilz.us](http://www.pilz.us)

# ► Support

Technical support is available from Pilz round the clock.

## Americas

**Brazil**  
+55 11 97569-2804

**Canada**  
+1 888-315-PILZ (315-7459)

**Mexico**  
+52 55 5572 1300

**USA (toll-free)**  
+1 877-PILZUSA (745-9872)

## Asia

**China**  
+86 21 60880878-216

**Japan**  
+81 45 471-2281

**South Korea**  
+82 31 450 0680

## Australia

+61 3 95446300

## Europe

**Austria**  
+43 1 7986263-0

**Belgium, Luxembourg**  
+32 9 3217575

**France**  
+33 3 88104000

**Germany**  
+49 711 3409-444

**Ireland**  
+353 21 4804983

**Italy**  
+39 0362 1826711

## Scandinavia

+45 74436332

## Spain

+34 938497433

## Switzerland

+41 62 88979-30

## The Netherlands

+31 347 320477

## Turkey

+90 216 5775552

## United Kingdom

+44 1536 462203

## You can reach our international hotline on:

+49 711 3409-444  
support@pilz.com

Pilz develops environmentally-friendly products using ecological materials and energy-saving technologies. Offices and production facilities are ecologically designed, environmentally-aware and energy-saving. So Pilz offers sustainability, plus the security of using energy-efficient products and environmentally-friendly solutions.



Presented by:



Pilz GmbH & Co. KG  
Felix-Wankel-Straße 2  
73760 Ostfildern, Germany  
Tel.: +49 711 3409-0  
Fax: +49 711 3409-133  
info@pilz.com  
www.pilz.com

