



PX Series Print Engine

Made in Germany

PX print engines

Our goals are:

Perfect function, high reliability, easy to handle operation and less maintenance downtime.

The PX print engine is designed especially for the fully automatic print and apply operation in the industrial use. It can be integrated in each orientation and used for complex labeling applications.



A solid cast aluminum design is base for the assembly of all components of the printing mechanics. A food safe coating and stainless steel covers make the PX print engine perfect with outstanding features. It is bolt compatible with competitive print engines.

The Universal

The industrial engine for the precise printing.

1.1	Print engine	PX4			PX 4.3*	
	Print resolution dpi	203	300	600	203	300
	Print width up to mm	104	105,6	105,6	104	108,4
	Print speed up to mm/s	300	250	100	200	150

*4.3 preferably for thermal direct printing.

The Wide

Focused on Odette and UCC labels.

1.2	Print engine	PX6	
	Print resolution dpi	203	300
	Print width up to mm	168	162,6
	Print speed up to mm/s	200	200

Label peeling direction

Print engine PX „L“



left hand version

Print engine PX „R“



right hand version

All PX print engines are available in right and left hand version and different resolution.

Technical details



- 1 Big graphic display**
White backlight for optimum readability.
- 2 Navigator pad**
With illuminated lettering for interactive menu navigation.
- 3 CF memory card**
Slot for CF memory card for storage of label formats, fonts, texts, graphics, programs or databases.
- 4 USB slot**
Additional USB slot for service keys, keyboard, scanner or USB memory.
- 5 Power switch**
Attached to the front for easier handling.
- 6 Solid metal cover**
Made of die-cast aluminum with antibacterial coating. All casings are made of stainless steel.
- 7 Ribbon rewinder and unwinder**
The three-part tightening axles enable fast and easy ribbon exchange. Narrow ribbons can be fixed in any position.
- 8 Ribbon saver**
Used for labels that are only to be partially printed. During label feed the printhead is lifted in the blank area and the ribbon is stopped.

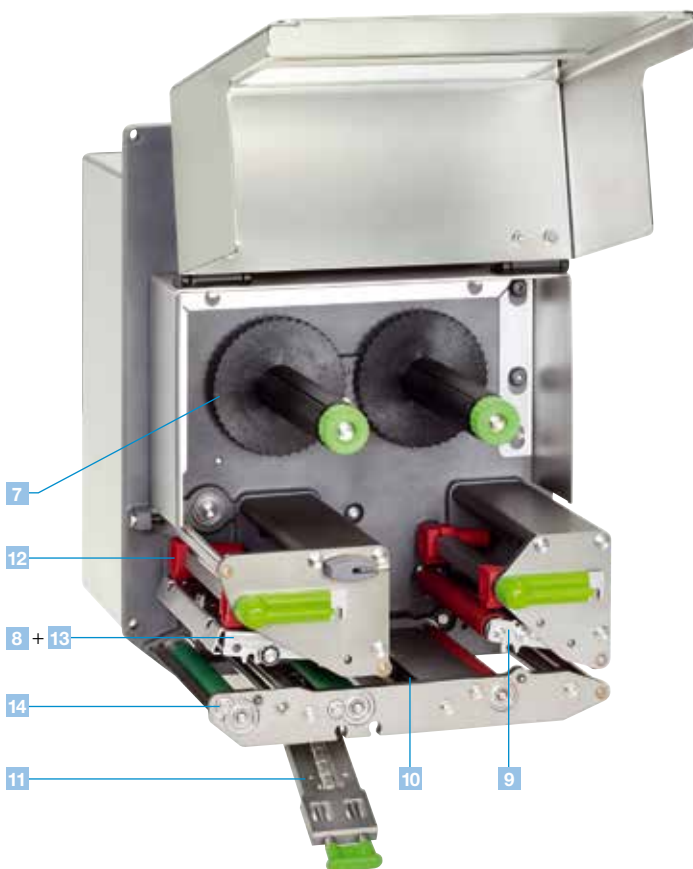

- 9 Back-feed**
Once a label has been dispensed, the next one can be fed back behind the print line to ensure it can be printed right to the edge and to prevent the liner from leaking adhesive during a longer pause. With very sensitive materials and to avoid ribbon folds, the printhead can be raised during this process.
- 10 Label sensor**
The gap or reflective sensor ensures the label is positioned precisely and identifies the end of the material – independent of gaps.
- 11 Simple material replacement**
The label material is inserted edgewise up to the end position. The printhead and pressure roller are locked with locking levers.
- 12 Adjustment of the print layout**
The pressure can be adjusted easily by moving the plungers.
- 13 Fast printhead exchange**
The printhead can be exchanged and adjusted easily using the Allen key, which is ready to hand at the machine.
- 14 Removing the print roller**
The print roller can be easily removed for cleaning or replacement.

Technical data

■ Standard □ Option ○ Authorized distribution by resellers

Print modul	PX4			PX4.3 ²⁾		PX6	
Printhead							
Printing method	Thermal transfer / Thermal direct						
Print resolution dpi	203	300	600	203	300	203	300
Print speed up to mm / s	300	250	100	200	150	200	200
Print width up to mm	104	105,6	105,6	104	108,4	168	162,6
Material							
Labels, continuous rolls or fan-folded	Paper, cardboard, textiles, plastics such as PET, PE, PP, PI, PVC, PU, Acrylat						
Thickness mm / weight g/m ²	0,055 - 0,35 / 60 - 160						
Label width ¹⁾ mm	10 - 116					50 - 174	
Width of carrier ¹⁾ mm	25 - 120					50 - 178	
Label height ¹⁾ min. mm without back-feed min. mm when dispensing ¹⁾ max. mm	6	6	6	6	6	12	12
	12	12	12	12	12	25	25
	5000	4000	1000	5000	4000	4000	3000
Ribbon							
Ink	Outside or inside						
Roll diameter up to mm	86						
Core diameter mm	25						
Ribbon length variable up to m	600						
Width ³⁾ up to mm	114						165
Ribbon saver	□						
Label sensor							
Gap sensor	For leading edge of the label or punching marks and end of material						
Reflective sensor from the bottom	For printing marks						
Distance to locating edge mm	4 - 60						
Electronics							
Processor high speed 32 Bit ColdFire / speed MHz	266						
RAM MB	64						
Memory IFFS MB Flash	8						
Slot for CompactFlash Type I	■						
Slot for wireless LAN card	■						
Real-time clock, printout of date and time	■						
Interfaces							
Centronics bidirectional acc. to IEEE 1284	□						
RS232 C 1,200 to 230,400 Baud / 8 Bit	■						
USB 2.0 high speed slave for PC connection	■						
Ethernet 10 / 100 Base T, LPD, RawIP printing, ftp printing, DHCP, HTTP, FTP, SMTP, SNMP, TIME, Zeroconf, mDNS, SOAP	■						
RS422, RS485 1.200 up to 230.400 Baud / 8 Bit	□						
WLAN card 802.11b / g WEP / WPA PSK (TKIP)	□						
Wireless Bridge 802.11b	□						
2x USB master for external operation panel, keyboard, scanner or service key, USB flash drive	■						
Digital I/O interface (cab other OEM version)	■						
Operating data							
Power supply	100 - 240 V ~ 50 / 60 Hz, PFC						
Energy consumption	max. 250 W						
Operating temperature / Humidity	Operation:	+ 5 - 40°C / 10 - 85% not condensing					
	Stock:	+ 0 - 60°C / 20 - 85% not condensing					
	Transport:	- 25 - 60°C / 20 - 85% not condensing					
Approvals	CE, FCC class A, CB, CCC, UL						
Operation panel							
Buttons / LED display	Pause, Feed, Cancel, Menu, Enter, 4 x Cursor						
LCD graphic display	Text 4 lines, ca. 20 characters per line						
Width x Height mm	60 x 40						
Settings							
	Digital or analog clock System settings	Print parameters 24 language settings	Interfaces Security	Time Date			
Monitoring							
Stop printing if:	End of ribbon End of label Printhead open						
On the display	Data reception WLAN field intensity Ethernet status	Used memory Temperature of printhead Access to memory card	Clock Date sheet abc Debug	Input buffer Remaining quantity of ribbon			

¹⁾ Limitations may apply to small labels, thin materials or strong adhesives. Critical materials or applications must be tested and approved.

²⁾ Preferred for thermal transfer printing.

³⁾ The ribbon should be roughly the same width as the label in order to avoid folding.

Technical data

Test routines	
System diagnosis	When switched on, incl. printhead testing
Short status, status print	Font list, device list, WLAN status, profile of label, test grid, monitor mode, PPP status
Status reports	Extensive status printout with information about setting, e.g. print length counter, runtime counter etc. Request of machine status via software command. Detailed status messages on the display, e.g. network error – no link, barcode error, etc..
Fonts	
Font types	5 Bitmap fonts incl. OCR-A, OCR-B and 3 Vector fonts Swiss 721, Swiss 721 Bold and Monospace 821 available internally, loadable TrueType fonts. Thai and Chinese (simplified Chinese) available as options.
Character sets	Windows 1250 up to 1257, DOS 437, 737, 775, 850, 852, 857, 862, 864, 866, 869, EBC DIC 500, ISO 8859-1 to -10 and -13 up to -16, WinOEM 720, UTF-8, Macintosh Roman, DEC MCS, KOI8-R. All West and East European Latin, Cyrillic, Greek, Hebrew and Arabic characters are supported. Thai and Chinese available as options.
Bitmap fonts	Size of width and height 1 – 3 mm Zoom 2-10 Orientation 0°, 90°, 180°, 270°
Vector / TrueType fonts	Size of width and height 0.9 – 128 mm Variable zoom, Orientation 360° in steps of 1°
Font formats	Bold, italic, underlined, outline, negative, gray, vertical, depending on character fonts
Font width	Variable
Graphics	
Graphic elements	Line, arrow, box, circle, ellipse, filled and filled with fading
Grafikformate	PCX, IMG, BMP, TIF, MAC, GIF, PNG

Barcodes			
Linear barcodes	Code 39, Code 93	Interleaved 2 / 5	
	Code 39 Full ASCII Code 128 A, B, C EAN 8, 13 EAN / UCC 128 EAN / UPC Appendix 2 EAN / UPC Appendix 5 FIM HIBC	Ident- u. Leitcode der Deutschen Post AG Codabar JAN 8, 13 MSI Plessey Postnet RSS 14 UPC A, E, E0	
2D codes	Aztec, Codablock F, Data Matrix, PDF 417, Micro PDF 417, UPS Maxicode, QR-Code, RSS 14 truncated, limited, stacked and stacked omnidirectional, EAN-Datamatrix, GS1 Data Bar		
	All codes variable in height, module width and ratio. Orientation 0°, 90°, 180°, 270°. Optionally with check digit, printed characters and start/stop code, depending on code type.		
Software			
Programming	J-Script direct programming abc-Basic Compiler Database Connector	■ ■ □	
System diagnosis / administration	Printer monitoring Network Manager	■ □	
Label software	cablabel R2+ Codesoft, NiceLabel, Easylabel Bartender, Label Matrix, Labelview	■ ○ □ ○	
Windows driver certified	32 / 64 bit for Windows XP Windows Vista Windows 7 Windows 8	Server 2003 Server 2008 Server 2008 R2 Server 2012	■
Mac driver	OS X printer driver from version 10.6	■	
Linux driver	CUPS-based from version 1.2	■	
Stand-alone-operation		■	

Interfaces















- 1 RS232C interface
- 2 USB 2.0 slave interface
- 3 Ethernet 10/100 Base T interface with TCP/IP
- 4 Slot for wireless LAN card
- 5 Two USB master interfaces for connecting an external operation panel, keyboard, scanner or service key
- 6 Slot for CompactFlash Type I memory card

- 7 Digital I/O interface
25-pin SUB D socket
Each of the 24V inputs and outputs are electrically isolated

Inputs	Outputs
Label feed	Warning if end of ribbon
Repeat print run	Warning if end of label
Start printing	Paper feed ON
Pause	Print start
Label dispensed	Error end of ribbon
Cancel re-set with memory	Error end of label
Cancel re-set without memory	Print data available
	Operating status
	Label in dispensing position
	Error printer
- 8 OEM – digital I/O interface
15-pin SUB D socket
Each of the 5V inputs and outputs are electrically isolated

Inputs	Outputs
Label feed	Warning if end of ribbon
Repeat print run	Paper feed ON
Start printing	Error end of ribbon
Cancel reset without memory	Error end of label
	Print data available
	Label in dispensing position
	Error printer

Accessories

Extras	
2.1	 <p>External panel Connected via USB interface. Both panels provide the same functionality.</p>
2.2	 <p>Interface cover Protects the interfaces against humidity and contamination.</p>
2.3	 <p>25-pin SUB D interface connector With screw clamps for the cable connection.</p>
2.4	 <p>15-pin SUB D interface connector With screw clamps for the cable connection.</p>
2.5	 <p>Memory card CompactFlash Type I</p>
2.6	 <p>Standard keyboard USB German Version</p>
Interfaces	
3.1	 <p>Centronics interface bidirektional nach IEEE 1284</p>
3.2	 <p>Interface RS422/RS485 1.200 up to 230.400 Baud/8 Bit</p>
3.3	 <p>Label selection box – I/O box From a higher-level control, like a PLC, up to 16 different labels can be selected from the memory card. The I/O box enables via abc programming to realize easy programming of the PLC with the 4 in- and outputs.</p>
3.4	 <p>WLAN card 802.11 b/g</p>
Connecting cable	
4.1	 <p>Connecting cable RS232 C 9/9 pin, length 3 m</p>
4.2	 <p>Patch cable KAT 5e, 3 m grau</p>



Device functionality and compliance with CE standards are only warranted by using the accessories provided or recommended by cab.

Software tools

11.1

J
 H 100
 O R
 S I1;0,0,68,70,100
 T 10, 10,0,5,pt20;sample
 B 10,20,0,EAN-13,SC2,401234512345
 G 8,3,5,0;R:30,9,0,3;0,3
 A 1

Job start
Speed (100 mm/s)
Orientation rotated by 180°
Size of label (100x68 mm, gap 2 mm)
Text object/font: Swiss bold, 20 pt
Barcode EAN 13, size SC 2
Graphic, box 30 x 9 mm,
Line strength 0.3 mm
Number of labels (in this example 1)

Direct programming with J-Script

JScript is the programming language for cab printers. The printer language is easy to understand and to program. JScript is described in the programmer's guide and can be created with any text editor.

11.2

SAP® Member Printer Vendor Program

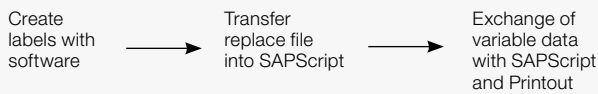

Replace files and integration in SAP R/3*

In cooperation with SAP cab developed the so-called „replace method“ to control cab printers quickly and easily from SAPScript using SAP R/3. The host computer only sends the JScript variable, respectively changed data to the printer. As a Silver Level partner in SAP's Printer Vendor Program, cab has access to the SAP development area for optimum printer support in SAP environments.

* SAP and R/3 are registered trademarks of SAP AG.

11.3

```

    <ABC>
    label start
    input a$
    if left$(a$,15)="194300301480070" then
        print "R t2;";mid$(a$,16)
    endif
    if left$(a$,15)="194300300580172" then
        print "R t3;";mid$(a$,16)
    endif
    if left$(a$,15)="194300301970073" then
        print "R t1;";mid$(a$,16)
    endif
    if a$="Q0001" then
        print "A 1"
    endif
    goto start
    
```

abc – Basic Compiler

As an integrated element of the firmware, the Basic Compiler enables the printer to process data via BASIC programming before it is sent for print editing. This makes it possible for external printer languages to be replaced or data from other systems, e.g. a PLC or balance to be transferred and printed. For example:

communication with balance



11.4

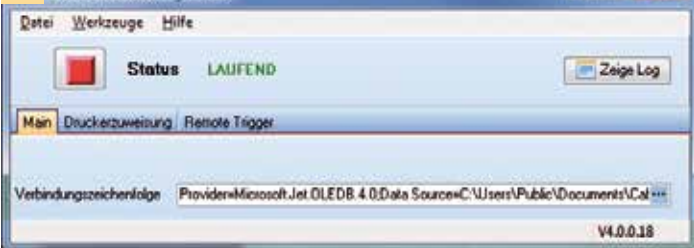

Database Connector

In the stand-alone mode with additional network connection, the Database Connector enables stand-alone printers to access data directly from a central ODBC-, OLEDB compatible database and to print it as a label. At the same time, data can also be written back to the database or changed during the printing process.

11.5



Printer monitoring with Intranet and Internet

Using standard programs such as the web browser or FTP clients, the integrated HTTP and FTP server enables print monitoring, configuration, firmware updates and memory card administration. Status, warning and error messages are sent to administrators or users as e-mails or SNMP datagrams via SNMP and SMTP clients.

A time server is used to synchronize time and date.

11.6

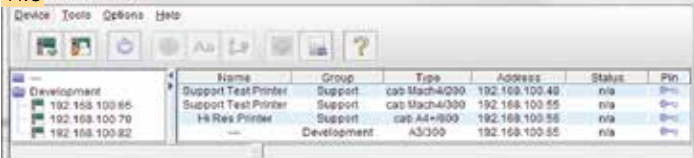

Administration Network Manager

The cab Network Manager enables the user to control a number of printers across a network simultaneously. It supports monitoring, configuration, firmware updates, memory card administration, file synchronization and PIN administration centrally.

Printer drivers

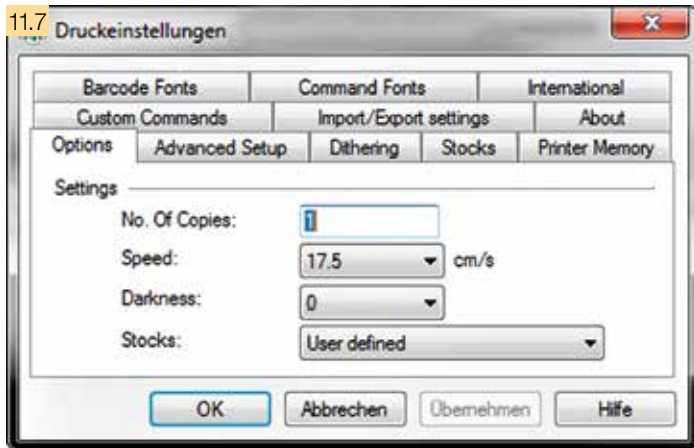

WHQL certified Windows printer driver for

- | | |
|---------------|------------------------|
| Windows XP | Windows Server 2003 |
| Windows Vista | Windows Server 2008 |
| Windows 7 | Windows Server 2008 R2 |
| Windows 8 | Windows Server 2012 |

Our printer drivers are officially certified and signed by Microsoft. They ensure optimum stability on your Windows operating system.

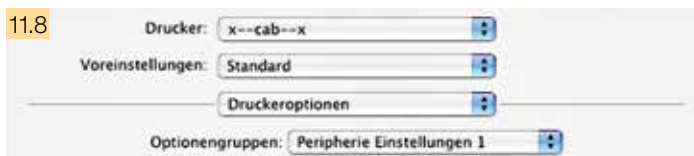

Apple-Mac OS X® driver

Alternatively, cab offers a CUPS-based printer driver for programs using Mac OS X.



Linux driver

Alternatively, cab offers a CUPS-based printer driver for programs using Linux.

*Microsoft® is a registered trademark of Microsoft Corporation.
Mac OS® is a registered trademark of Apple Computer, Inc.*

Label software

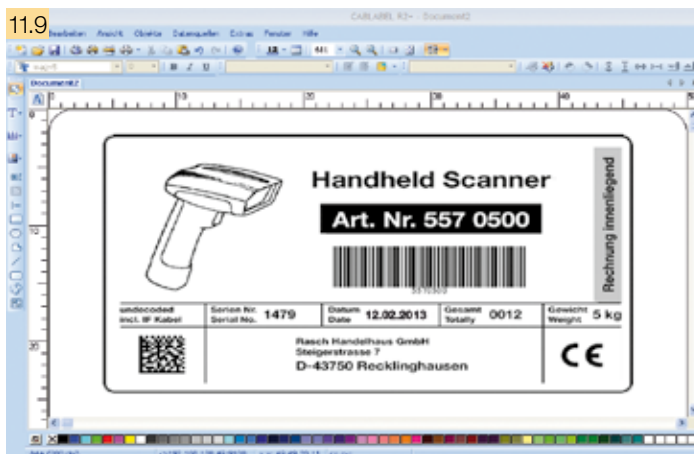

Powerful label software that is free of charge and specially designed for cab printers and print and apply systems

Different fonts, barcode and graphics in variable heights, widths and printing directions can be used to produce the best possible label design.

High-performance functions enable to design and print even complex labels in just a few minutes. cablabel R2+ supports special functions of the cab printers, such as real-time clock, label counter, stand-alone operation (operation without connection to host or PC) or printout of the printer data stream in a file.

Additional label software

Highest possible variability – other commercially available label software solutions, such as Codesoft, NiceLabel, Easylabel, Bartender, Label Matrix or Labelview support the cab label printers and labeling systems. More information available on our website.

cablabel R2+ is available in 24 different languages for the following operating systems:

- | | |
|---------------|---|
| Windows XP | Windows Server 2003* |
| Windows Vista | Windows Server 2008* |
| Windows 7 | * Terminalserver / Citrix are not supported |

11.10

Programmer's guide

A general programmer's guide explaining and describing commands for different printer models via direct programming.



Printing without PC

Stand-alone operation is the ability to print labels even if the print engine is not connected to the host system.

The label layout is designed with a special label software or direct programming via PC.

Label formats, fonts, font-, text- and graphics data as well as data base contents are saved or read on the USB stick or internal data memory IFFS.

Only variable data to be printed is sent to the printer via keyboard or host. Additionally, data sent by a barcode scanner or scale can be processed.



Easy maintenance

Printhead 203 / 300 / 600 dpi

The printhead can be exchanged and adjusted easily using the Allen key, which is ready to hand at the machine.



Removing the print roller

The print roller can be easily removed for cleaning or replacement.



Service







Our well-trained service engineers give world-wide support in maintenance and repair of cab printers. Please send your printer to one of cab's service centres or to one of the service partners selected by us. We will check and repair your printer within only a few working days. If requested, we will make a temporary equivalent device available for the time of repair.







Training

We offer training in programming, different software tools, printer drivers and label layout design. You will enhance your knowledge on cab printers to make more effective use of our printers. We also offer seminars for maintenance and repair.

Delivery program for the PX print module

	Part no.	Hardware	dpi	
1.1		5956102.xxx 5956103.xxx 5956106.xxx	Print module PX4L / 200 Print module PX4L / 300 Print module PX4L / 600	
		5956142.xxx 5956143.xxx	Print module PX4.3L / 200 Print module PX4.3L / 300	
		5956112.xxx 5956113.xxx 5956116.xxx	Print module PX4R / 200 Print module PX4R / 300 Print module PX4R / 600	
		5956152.xxx 5956153.xxx	Print module PX4.3R / 200 Print module PX4.3R / 300	
	1.2		5956235.xxx 5956123.xxx	Print module PX6L / 200 Print module PX6L / 300
			5956236.xxx 5956133.xxx	Print module PX6R / 200 Print module PX6R / 300
	Part no.	Hardware optionen		
	595.xxx.201	Digital I/O interface		
	595.xxx.202	Digital I/O interface Ribbon saver		
	595.xxx.203	OEM – Digital I/O interface		
	595.xxx.204	OEM – Digital I/O interface Ribbon saver		
	Scope of delivery			
	PX print module as label printer, Power cable type E+F, length 1.8 m, Connecting cables USB, length 1.8 m Operating manual de/en DVD: Operating manual de/en/fr, Configuration manual de/en/fr, Service manual de/en, Spare parts list de/en, Programming manual en, Windows printer driver 32/64 bit in 19 languages for Windows XP Server 2003 Windows Vista Server 2008 Windows 7 Server 2008 R2 Windows 8 Server 2012 Label software cablabel R2+ in 24 languages Database Connector de/en/fr			
	Part no.	Consumables		
	5956381.001 5956382.001 5956383.001	Printhead 4 / 203 Printhead 4 / 300 Printhead 4 / 600		
	5954085.001 5956384.001	Printhead 4.3 / 200 Printhead 4.3 / 300		
	5954217.001 5956322.001	Printhead 6 / 200 Printhead 6 / 300		
	5954180.001	Print roller DR4		
	5954245.001	Print roller DR6		

	Part no.	Accessories	
2.1		5954380	External operation panel
2.2		5965040	Interface cover
2.3		5917651	Interface connector 25-pin SUB D with screw clamps for cable connection
2.4		5917652	Interface connector 15-pin SUB D with screw clamps for cable connection
2.5		5561043	CompactFlash Type I memory card
2.6		5901626	Compact keyboard USB Cherry G84-4100
	Part no.	Interfaces	
3.1		5954200	Centronics interface
3.2		5954201	RS422 / RS485 interface
3.3		5954191	Label selection box – I/O box
3.4		5561041	WLAN card 802.11 b/g
	Part no.	Connecting cable	
4.1		5550818	Connecting cable RS232 C 9/9 pin, length 3 m
4.2		5918008	Patch cable KAT 5e, 3 m gray
	Part no.	Software	
11.4		DL 40100	Database Connector license
11.6		5580215	Administration Network Manager
11.9		included	Label software cablabel R2+
		on request	Codesoft, Nice Label, Easylabel
11.10		9008486	Programming manual english, printed copy

Dimensions

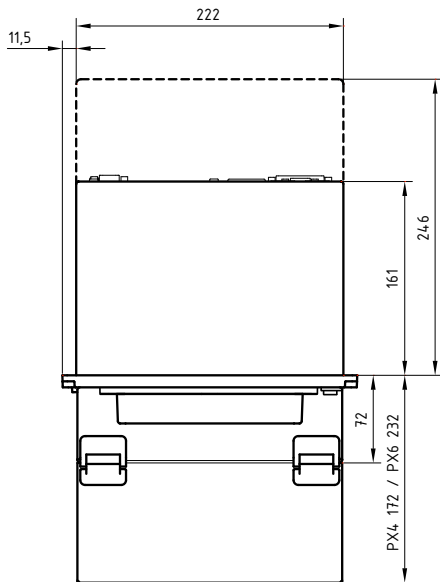
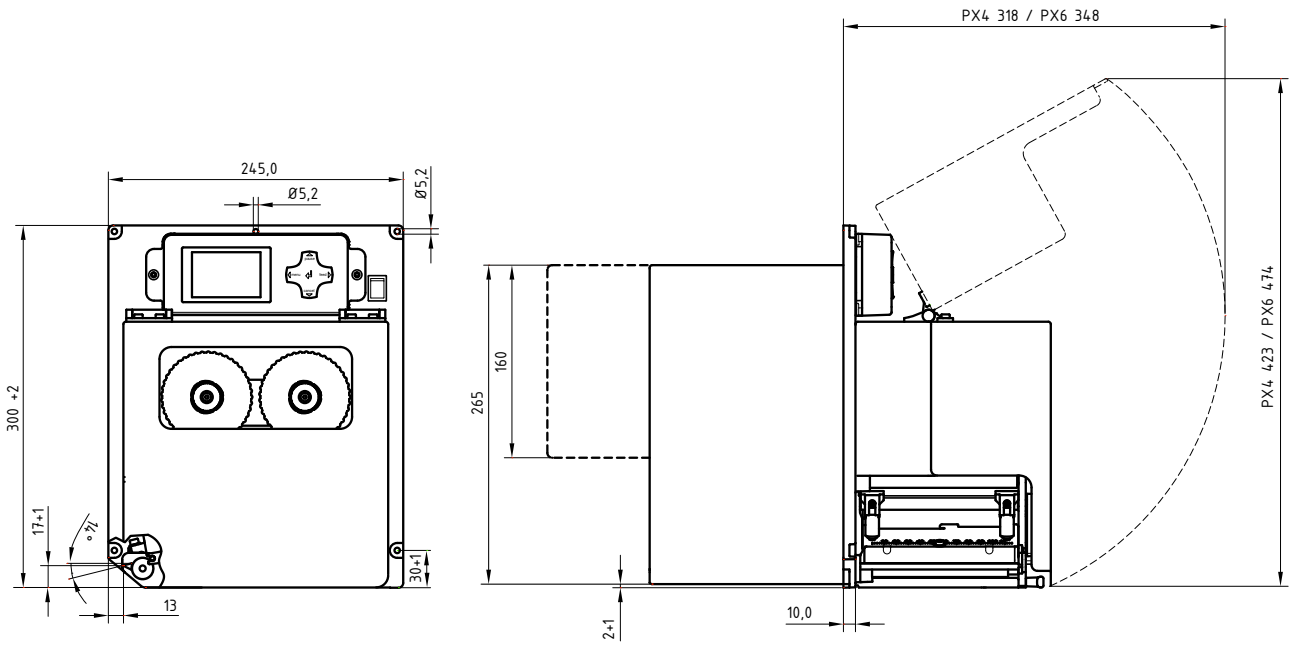

Weight of print module	PX4	PX4.3	PX6
in kg	11,5	11,5	12

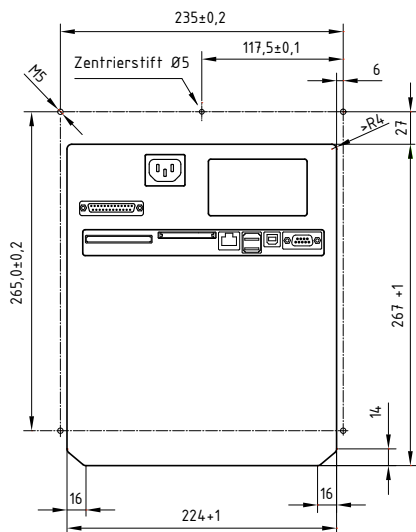

cab delivery program

Label printer EOS1
The compact for
label rolls up to 155 mm Ø



Label printer EOS4
The cost-effective for
label rolls up to 210 mm Ø



Label printer MACH4
The versatile
for a smooth workflow



Label printer A+ series
The universal



Label printer A+ M
With centered material guide



Label printer XD4
Double-sided printing



Textile printer A4+T
For textile material



Label printer XD4T
Double-sided printing of
textile material



Label printer XC4
Two-color printing



Label printer XC6
Two-color printing



Label dispenser HS
Precise and easy dispensing in
horizontal direction
up to a width of 180 mm



Label dispenser VS
Precise and easy dispensing in
vertical direction
up to a width of 180 mm



Print & apply system Hermes+
For automation



Print module PX series
For integration into automatic
labeling systems



Labels / Transfer ribbons
Precise printing with cab's
labels and transfer ribbons



Label software
Standard and optional software



Laser marking system FL series
Precise and fast



Laser safety housing
The industrial solution



- Headquarter in Germany
- cab subsidiaries
520 distribution partners
in more than 80 countries.

cab is represented in every active
commercial center - worldwide.

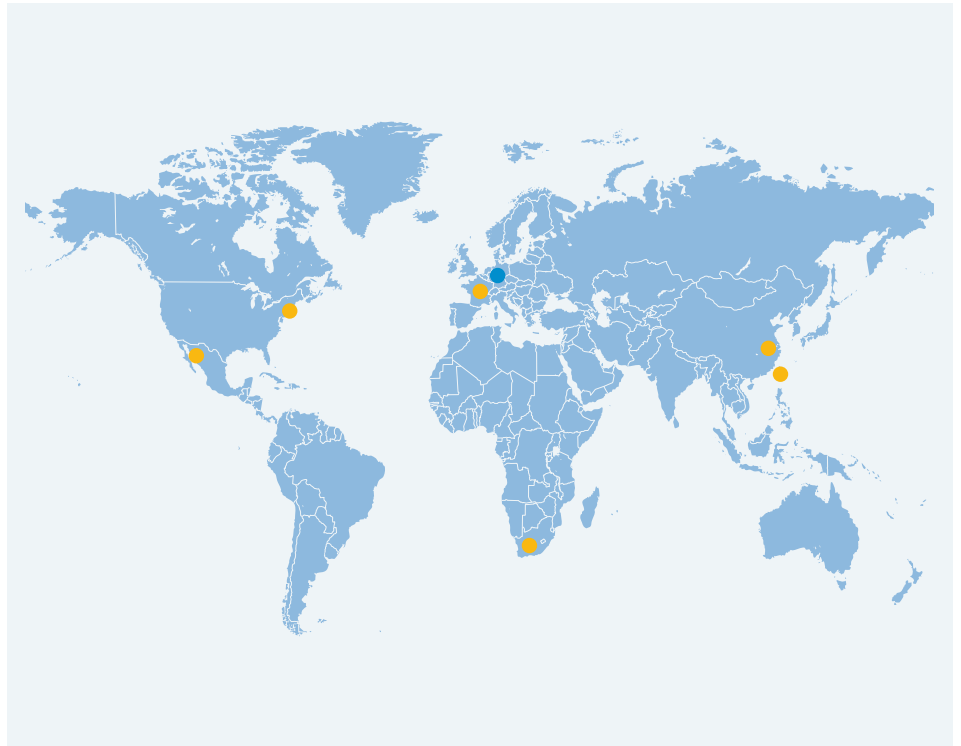

For current data, please refer to www.cab.de

Germany

cab Produkttechnik
GmbH & Co KG
Postfach 1904
76007 Karlsruhe
Wilhelm-Schickard-Str. 14
76131 Karlsruhe
Telefon +49 721 6626-0
Telefax +49 721 6626-249
www.cab.de
info@cab.de

[Further partners on request](#)

France

cab technologies s.a.r.l.
67350 Niedermodern
Téléphone +33 388 722 501
www.cab.de/fr
info.fr@cab.de

USA

cab Technology Inc.
Tyngsboro MA, 01879
Phone +1 978 649 0293
www.cab.de/us
info.us@cab.de

South Africa

cab Technology (Pty.) Ltd.
2125 Randburg
Phone +27 11-886-3580
www.cab.de/za
info.za@cab.de

Asia 亚洲

cab Technology Co, Ltd.
希爱比科技股份有限公司
Junghe, Taipei, Taiwan
Phone +886 2 8227 3966
www.cab.de/tw
info.asia@cab.de

China 中国

cab (Shanghai) Trading Co., Ltd
铠博(上海)贸易有限公司
Phone +86 21 6236-3161
www.cab.de/cn
info.cn@cab.de

This documentation and any translations hereof are the property of cab GmbH & Co KG.

The replication, processing, reproduction or distribution in whole or in parts requires our prior written consent. © Copyright by cab/9008538.

All delivery, design and technical specifications are compiled to the best of our current knowledge and are subject to change without prior notice.