



UMG 511 – Class A power quality analyser

Communication

- Profibus (DP/V0)
- Modbus (RTU, TCP, Gateway)
- TCP/IP
- BACnet (optional)
- HTTP (configurable homepage)
- FTP (file transfer)
- TFTP
- NTP (time synchronisation)
- SMTP (email function)
- DHCP
- SNMP

Interfaces

- Ethernet
- Profibus / RS485 (DSUB-9)

Accuracy of measurement

- Energy: Class 0.2S (... / 5 A)
- Current: 0.2 %
- Voltage: 0.1 %

Power quality acc. Class A

- Harmonics up to the 63rd harmonic
- Flicker measurement
- Short-term interruptions (> 20 ms)
- Transient recorder (> 50 µs)
- Starting currents (> 10 ms)
- Unbalance
- Half wave RMS recordings (up to 4.5 min.)

Networks

- IT, TN, TT networks
- 3 and 4-phase networks

Measured data memory

- 256 MByte Flash

Programming language

- Graphical programming
- Jasic®
- PLC functionality

8 digital inputs

- Pulse input
- Logic input
- State monitoring
- HT / LT switching
- Emax resetting

5 digital outputs

- Pulse output kWh / kvarh
- Switch output
- Threshold value output
- Emax output
- Logic output

(expandable via external I/O modules)

Peak demand management (optional)

- Up to 64 switch-off stages

Network visualisation software

- GridVis®-Basic (in the scope of supply)
- PQ Report Generator



Areas of application



- Continuous monitoring of the power quality
- Harmonics analysis with power quality problems
- Checking the internal supply network according to EN 61000-4-7, EN 6100-4-15, EN 61000-4-30
- Fault analysis in case of problems with the energy supply
- Documentation of the power quality for customers and regulatory authorities
- Ethernet Gateway for subordinate measurement points
- Report generator for power quality standards: EN 50160, IEE519, ITIC ...
- Report generator for energy consumptions
- Energy Dashboard
- Remote monitoring of critical processes

Main features



Power quality

- Harmonics analysis up to the 63rd harmonic, even / odd (U, I, P, Q)
- Interharmonics (U, I)
- Distortion factor THD-U / THD-I / TDD
- Measurement of positive, negative and zero sequence component
- Unbalance
- Direction of rotation field
- Voltage crest factor
- Flicker measurement in accordance with DIN EN 61000-4-15
- Logging and storage of transients (> 50 μ s)
- Short-term interruptions (> 20 ms)
- Monitoring start-up processes

High quality measurement

- Constant true RMS measurement
- Measurement process in accordance with IEC 61000-4-30
- Certified accuracy of measurement according to class A
- Continuous sampling of the voltage and current measurement inputs at 20,000 Hz
- 400 measurement points per period
- Recording of over 2,000 measured values per measurement cycle
- Accuracy of active energy measurement: Class 0.2S
- Fast measurement even enables the logging of rapid transients from 50 μ s
- Logging of currents and voltages (15 – 440 Hz)

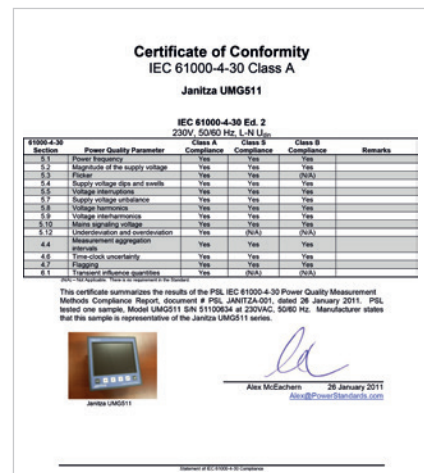

Fig.: UMG 511 Class A-certified



User-friendly, colour graphical display with intuitive user guidance

- High resolution colour graphical display 320 x 240, 256 colours, 6 buttons
- User-friendly, self-explanatory and intuitive operation
- Backlight for optimum reading, even in darker environments
- Illustration of measured values in numeric form, as a bar graph or line graph
- Waveform representation of current and voltage
- Clear and informative representation of online graphs and power quality events
- Multilingual: German, English, Russian, Spanish, Chinese, French, Japanese, Turkish ...

Various characteristics

- 4 voltage and 4 current measurement inputs, i.e. logging of N and / or PE possible
- 8 digital inputs, e.g. as data logger for S0 meter
- 5 digital outputs for alarm message or e.g. for connection to a BMS or PLC
- Free name assignment for the digital IOs, e.g. if used as data logger

Comprehensive communication and connection possibilities

- Modbus
- Profibus
- Ethernet (TCP/IP)
- Digital IOs
- BACnet (optional)
- Configurable Firewall



Modern communications architecture via Ethernet

- Simple integration in an Ethernet network
- Reliable and cost-optimised establishment of communication
- Ideal for Master-Slave structures
- High flexibility due to the use of open standards
- Integration in PLC systems and BMS through additional interfaces
- Various IP protocols: SNMP, ICMP (Ping), NTP, FTP ...

Transients (1..8)		
Phase	Reason	Date/Time
L1	delta	2011 Mar 16 15:33:07,122
L4	delta	2011 Mar 16 15:32:29,826
L3	delta	2011 Mar 16 15:32:29,819
L2	delta	2011 Mar 16 15:32:29,813
L2	delta	2011 Mar 16 15:32:29,806
L1	delta	2011 Mar 16 15:32:29,799
L4	delta	2011 Mar 16 15:32:29,793
L3	delta	2011 Mar 16 15:32:29,786

Fig.: Transients list

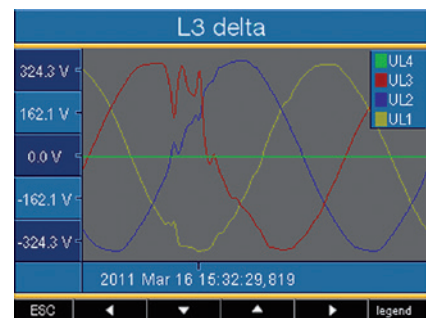

Fig.: Graphical representation of a transient



Measuring device homepage

- Web server on the measuring device, i.e. device's inbuilt homepage
- Function expansion possible through APPs
- Remote operation of the device display via the homepage
- Comprehensive measurement data incl. PQ (transients, events...)
- Online and historic data available directly via the homepage
- Waveform representation of current and voltage
- Password protection



Fig.: Illustration of the historic data via the homepage



BACnet protocol for building communication

- Optimal interoperability between devices from various manufacturers
- Predefined BIBBs (BACnet Interoperability Building Block)
- BACnet is optionally available with UMG 511
- UMG 511 supports the device type B-SA with the BIBBs DS-RP-B and DS-WP-B
- Furthermore, the BIBBs DS-COV-B and DM-UTC-B are also supported

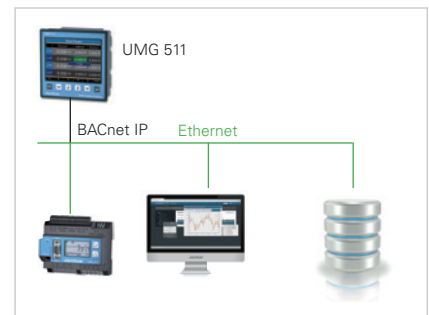

Fig.: BACnet topology



Modbus Gateway function

- Economical connection of subordinate measuring devices without Ethernet interface
- Integration of devices with Modbus-RTU interface possible (harmonisation of data format and function code necessary)
- Data can be scaled and described
- Minimised number of IP addresses required
- Tried and tested integrated solution without additional hardware



Programming / PLC functionality

- Further processing of the measurement data in the measuring device (local intelligence)
- Monitoring and alarm functions simple to program
- Sustainable functional expansions far beyond pure measurement
- Comprehensive programming options with
 - Jasic® source code programming
 - Graphical programming
- Complete APPs from the Janitza library



Large measurement data memory

- 256 MB data memory
- Memory range up to 2 years (configuration-dependent)
- Individually configurable recordings

- Recording averaging times can be freely selected
- PQ recordings template preconfigured for conventional standards (e.g. EN 50160)
- User-defined memory segmenting possible

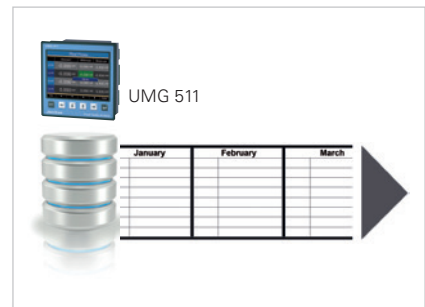

Fig.: Large measurement data memory



Powerful alarm management

- Information available immediately by email
- Inform maintenance personnel via the powerful device homepage
- Via digital outputs, Modbus addresses, GridVis® software
- Programming via Jasic® or graphical programming
- Further alarm management functions via GridVis®-Service alarm management

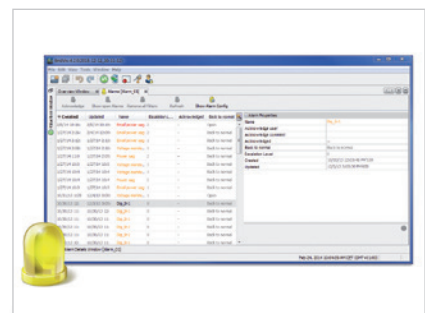

Fig.: GridVis® alarm management, alarm list (logbook)



Peak load representation and peak load management

- Illustration of the 3 highest monthly power peaks on the LCD display (P, Q, S)
- Rolling bar chart representation of the peak power values over 3 years on the LCD display (P, Q, S)
- Plain text representation on the LCD display (P)
- Emax control of up to 64 channels (optional)

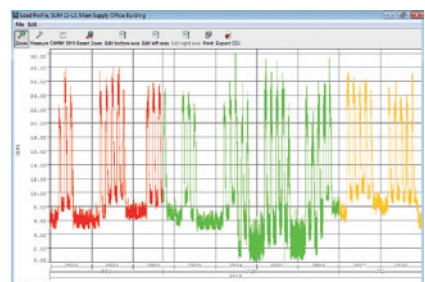

Fig.: GridVis® load profile, basic instrument for EnMS



GridVis®-Basic power quality analysis software

- Multilingual
- Manual read-out of the measuring devices
- Manual report generation (power quality and energy consumption reports)
- Comprehensive PQ analysis with individual graphs
 - Online graphs
 - Historic graphs
 - Graph sets
- Integrated databases (Janitza DB, Derby DB)
- Graphical programming
- Topology views
- High memory range

Certified quality through independent institutes

- ISO 9001
- Energy management certified according to ISO 50001
- Class A certificate (IEC 61000-4-30)
- UL certificate
- EMC-tested product



Dimension diagrams

All dimensions in mm

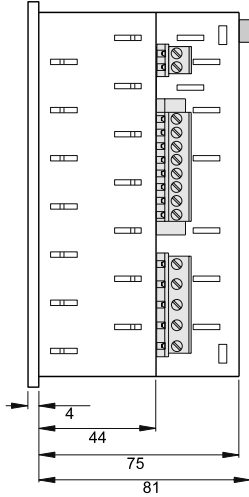

Side view

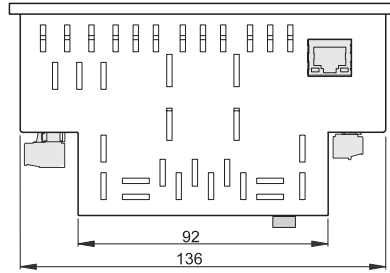

View from below

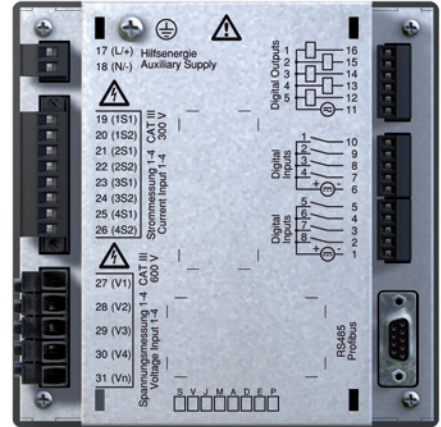

Rear view

Cut out: 138^{+0,8} x 138^{+0,8} mm



Typical connection

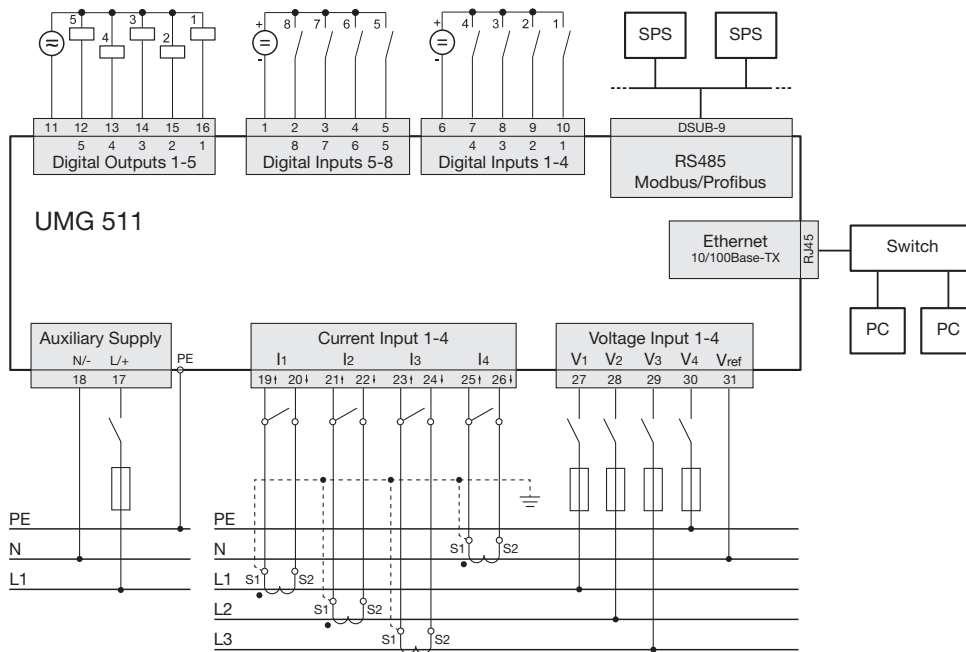



Device overview and technical data

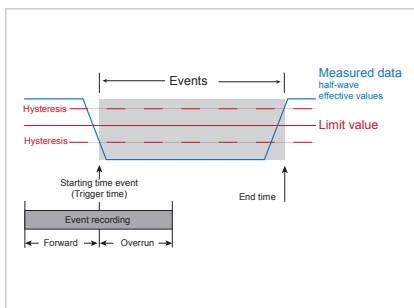

Fig.: The event record consists of a mean value, a minimum or maximum value, a start time and an end time.

	UMG 511		
Item number	52.19.001	52.19.002	52.19.003
Supply voltage AC	95 ... 240 V AC	44 ... 130 V AC	20 ... 50 V AC
Supply voltage DC	80 ... 340 V DC	48 ... 180 V DC	20 ... 70 V DC
Item number (UL)	52.19.011	52.19.012	
Supply voltage AC	95 ... 240 V AC	44 ... 130 V AC	
Supply voltage DC	80 ... 280 V DC	48 ... 180 V DC	
Device options			
Emax function	52.19.080	52.19.080	52.19.080
BACnet communication	52.19.081	52.19.081	52.19.081

General information	
Use in low, medium and high voltage networks	•
Accuracy voltage measurement	0.1 %
Accuracy current measurement	0.2 %
Accuracy active energy (kWh, .../5 A)	Class 0.2S
Number of measurement points per period	400
Seamless measurement	•
RMS - momentary value	
Current, voltage, frequency	•
Active, reactive and apparent power / total and per phase	•
Power factor / total and per phase	•
Energy measurement	
Active, reactive and apparent energy [L1, L2, L4, L3, Σ L1-L3, Σ L1-4]	•
Number of tariffs	8
Recording of the mean values	
Voltage, current / actual and maximum	•
Active, reactive and apparent power / actual and maximum	•
Frequency / actual and maximum	•
Demand calculation mode (bi-metallic function) / thermal	•
Other measurements	
Operating hours measurement	•
Clock	•
Weekly timer	Jasic®
Power quality measurements	
Harmonics per order / current and voltage	1st - 63rd
Harmonics per order / active and reactive power	1st - 63rd
Distortion factor THD-U in %	•
Distortion factor THD-I in %	•
Voltage unbalance	•
Current and voltage, positive, zero and negative sequence component	•
Flicker	•
Transients	> 50 μs
Error / event recorder function	•
Short-term interruptions	20 ms
Oscillogram function (wave form U and I)	•
Ripple voltage signal	•
Under and overvoltage recording	•
Measured data recording	
Memory (Flash)	256 MB
Average, minimum, maximum values	•
Measured data channels	8
Alarm messages	•
Time stamp	•
Time basis average value	freely user-defined
RMS averaging, arithmetic	•

Comment:
For detailed technical information please refer to the operation manual and the Modbus address list.

• = included - = not included

Displays and inputs / outputs	
LCD colour graphical display 320 x 240, 256 colours, 6 buttons	•
Language selection	•
Digital inputs	8
Digital outputs (as switch or pulse output)	5
Voltage and current inputs	each 4
Password protection	•
Peak load management (optionally 64 channels)	•
Communication	
Interfaces	
RS485: 9.6 – 921.6 kbps (DSUB-9 connector)	•
Profibus DP: Up to 12 Mbps (DSUB-9 connector)	•
Ethernet 10/100 Base-TX (RJ-45 socket)	•
Protocols	
Modbus RTU, Modbus TCP, Modbus RTU over Ethernet	•
Modbus Gateway for Master-Slave configuration	•
Profibus DP V0	•
HTTP (homepage configurable)	•
SMTP (email)	•
NTP (time synchronisation)	•
TFTP	•
FTP (file transfer)	•
SNMP	•
DHCP	•
TCP/IP	•
BACnet (optional)	•
ICMP (Ping)	•
Software GridVis®-Basic*1	
Online and historic graphs	•
Databases (Janitza DB, Derby DB); MySQL, MS SQL with higher GridVis® versions)	•
Manual reports (energy, power quality)	•
Graphical programming	•
Topology views	•
Manual read-out of the measuring devices	•
Graph sets	•
Programming / threshold values / alarm management	
Application programs freely programmable	7
Graphical programming	•
Programming via source code Jasic®	•
Technical data	
Type of measurement	Constant true RMS up to the 63rd harmonic
Nominal voltage, three-phase, 4-conductor (L-N, L-L)	417 / 720 V AC ^{*2}
Nominal voltage, three-phase, 3-conductor (L-L)	600 V AC
Measurement in quadrants	4
Networks	TN, TT, IT
Measurement in single-phase/multi-phase networks	1 ph, 2 ph, 3 ph, 4 ph and up to 4 times 1 ph
Measured voltage input	
Overvoltage category	600 V CAT III
Measured range, voltage L-N, AC (without potential transformer)	10 ... 600 Vrms
Measured range, voltage L-L, AC (without potential transformer)	18 ... 1000 Vrms
Resolution	0.01 V
Impedance	4 MOhm / phase
Frequency measuring range	15 ... 440 Hz
Power consumption	approx. 0.1 VA
Sampling frequency	20 kHz / phase
Measured current input	
Rated current	1 / 5 A
Resolution	0.1 mA
Measurement range	0.001 ... 8.5 Amps
Overvoltage category	300 V CAT III
Measurement surge voltage	4 kV
Power consumption	approx. 0.2 VA (Ri = 5 MOhm)
Overload for 1 sec.	120 A (sinusoidal)
Sampling frequency	20 kHz

Comment:
For detailed technical information please refer to the operation manual and the Modbus address list.

• = included - = not included

*1 Optional additional functions with the packages GridVis®-Professional, GridVis®-Enterprise and GridVis®-Service.

*2 With UL variants: 347/600 V

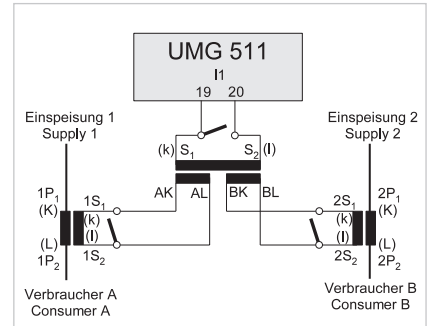

Fig.: Example, current measurement via a summation current transformer

Digital inputs and outputs	
Number of digital inputs	8
Maximum counting frequency	20 Hz
Reaction time (Jasic® program)	200 ms
Input signal present	18 ... 28 V DC (typically 4 mA)
Input signal not present	0 ... 5 V DC, current < 0.5 mA
Number of digital outputs	5
Switching voltage	max. 60 V DC, 30 V AC
Switching current	max. 50 mA Eff AC / DC
Output of voltage dips	20 ms
Pulse output (energy pulse)	max. 20 Hz
Maximum cable length	up to 30 m unscreened, from 30 m screened
Mechanical properties	
Weight	1080 g
Device dimensions in mm (H x W x D)	144 x 144 x approx. 81
Battery	Type CR1/2AA, 3 V, Li-Mn
Protection class per EN 60529	Front: IP40; Rear: IP20
Assembly per IEC EN 60999-1 / DIN EN 50022	Front panel installation
Connecting phase (U / I), Single core, multi-core, fine-stranded Terminal pins, core end sheath	0.2 to 2.5 mm ² 0.25 to 2.5 mm ²
Environmental conditions	
Temperature range	Operation: K55 (-10 ... +55 °C)
Relative humidity	Operation: 0 to 95 % RH
Operating height	0 ... 2,000 m above sea level
Degree of pollution	2
Installation position	user-defined
Electromagnetic compatibility	
Electromagnetic compatibility of electrical equipment	Directive 2004/108/EC
Electrical appliances for application within particular voltage limits	Directive 2006/95/EC
Equipment safety	
Safety requirements for electrical equipment for measurement, regulation, control and laboratory use – Part 1: General requirements	IEC/EN 61010-1
Part 2-030: Particular requirements for testing and measuring circuits	IEC/EN 61010-2-030
Noise immunity	
Class A: Industrial environment	IEC/EN 61326-1
Electrostatic discharge	IEC/EN 61000-4-2
Voltage dips	IEC/EN 61000-4-11
Emissions	
Class B: Residential environment	IEC/EN 61326-1
Radio disturbanc voltage strength 30 – 1000 MHz	IEC/CISPR11/EN 55011
Radiated interference voltage 0.15 – 30 MHz	IEC/CISPR11/EN 55011
Safety	
Europe	CE labelling
USA and Canada	UL variants available
Firmware	
Firmware update	Update via GridVis® software. Firmware download (free of charge) from the website: http://www.janitza.com/downloads/

Comment:
For detailed technical information please refer to the operation manual and the Modbus address list.

• = included - = not included

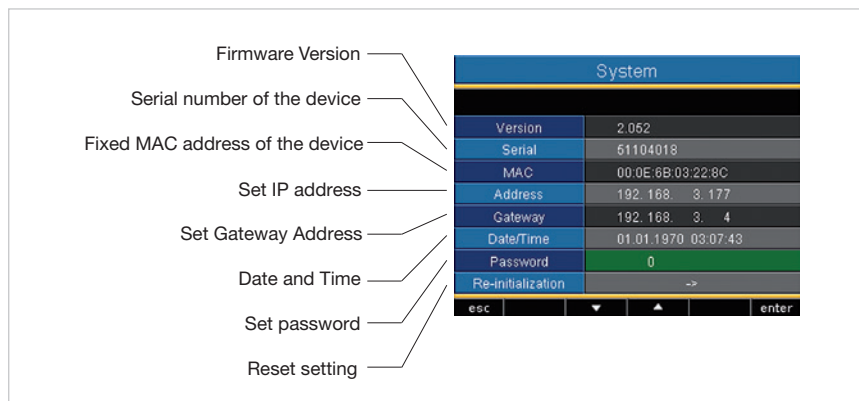

Fig.: User-friendly system of IP addresses, date, time and password

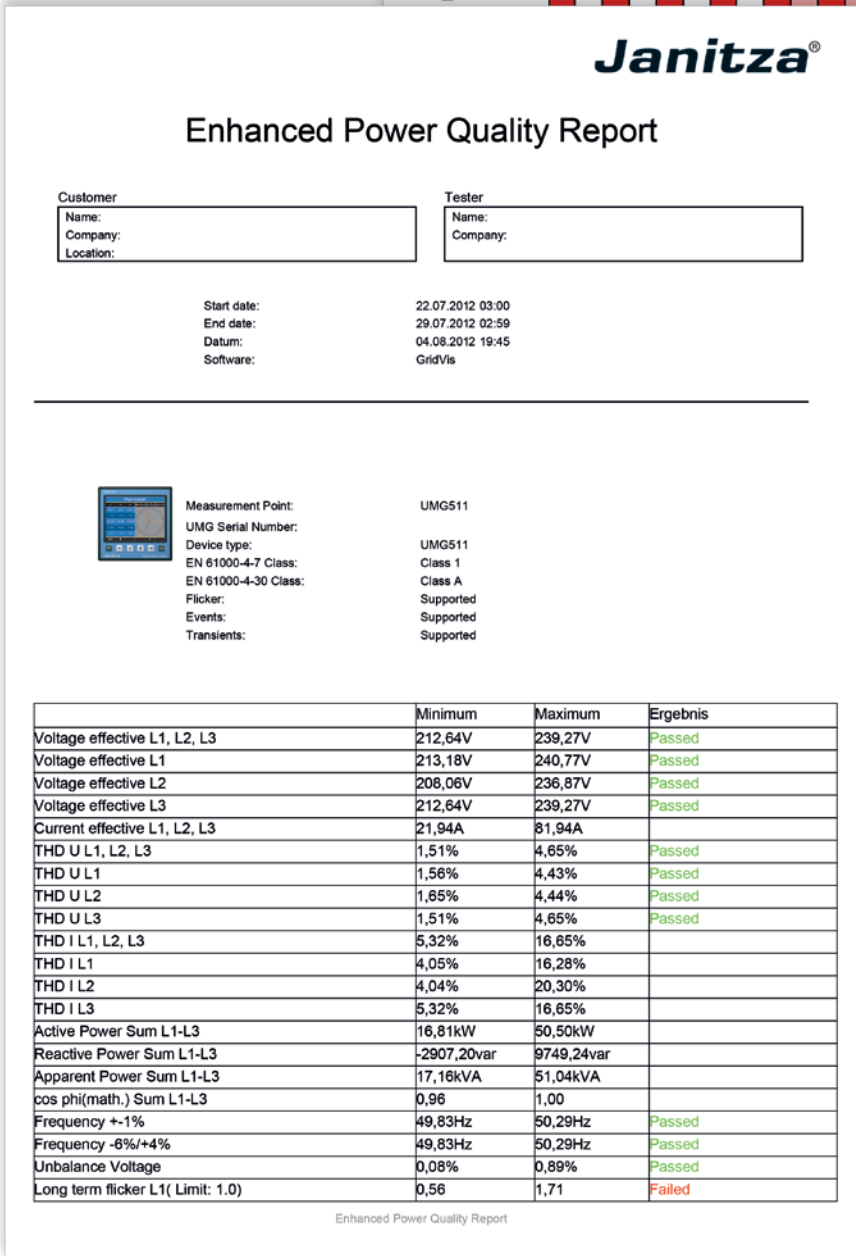
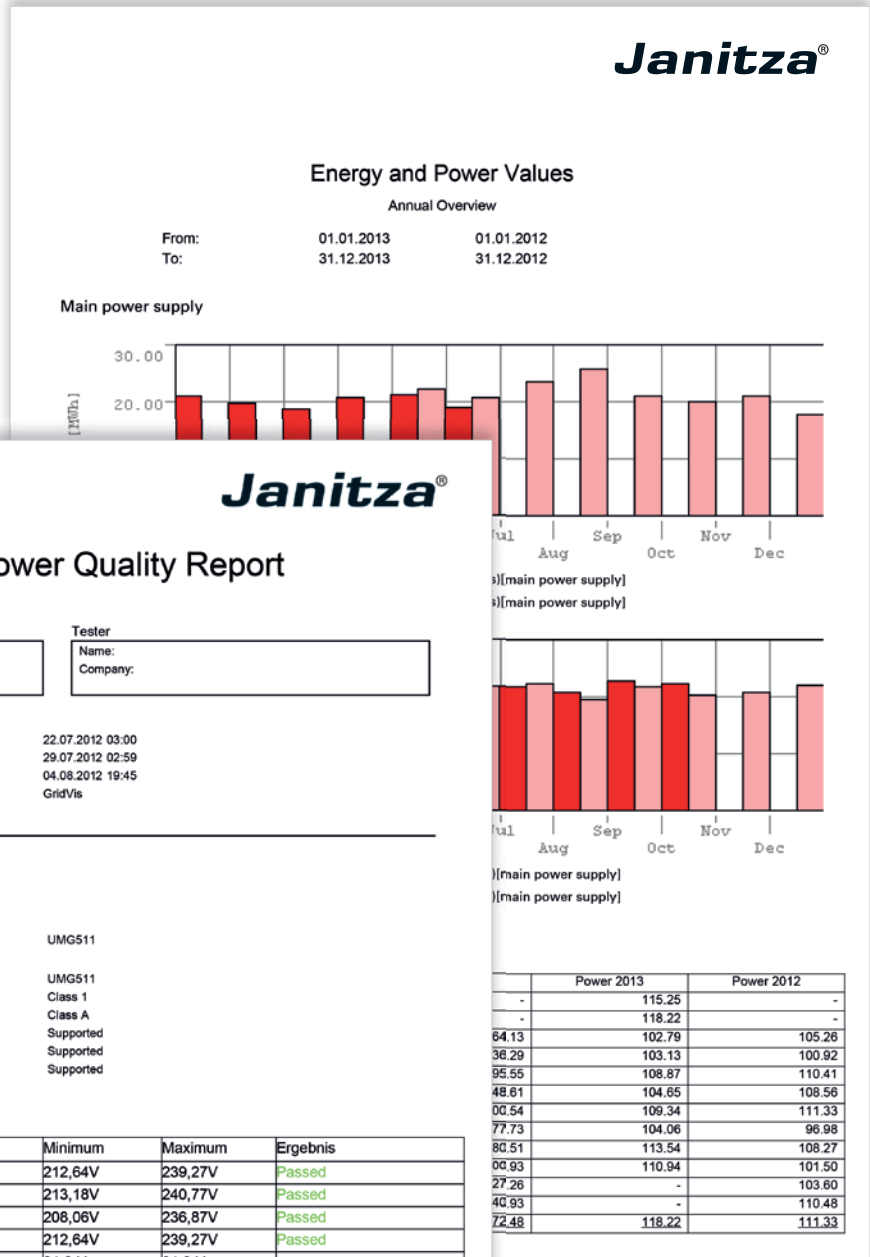

Fig.: Automatically generated power quality and energy report

Janitza electronics GmbH
Vor dem Polstück 1
D-35633 Lahnau
Germany

Tel.: +49 6441 9642-0
Fax: +49 6441 9642-30
info@janitza.de
www.janitza.com

Sales partner

Version 01/2015 • Subject to technical alterations.