



NEW
*Inexpensive Decopaint surface finishes
Golden Oak and Rosewood*



Roller Garage Door RollMatic

More free space in the garage with innovative Hörmann technology



Hörmann brand quality

Top safety and reliability



“A good reputation must be earned.” (August Hörmann)

In line with the founder’s philosophy, the Hörmann brand today is a true promise of quality. The family-owned company has over 75 years of experience in door and operator construction and, with sales of over 20 million doors, is no. 1 in Europe. This gives you a reassuring feeling when purchasing a Hörmann roller garage door.



Brand quality “Made in Germany”

All doors and operator components are developed and manufactured by Hörmann, are perfectly matched to each other and tested and certified by independent, recognised institutes to ensure your safety. They are manufactured in Germany according to the DIN ISO 9001 quality management system and fulfil all the requirements of European standard 13241-1. Our highly qualified employees also work intensively on new products, continual further developments and improvement to details. The results are patents and one-of-a-kind products you can depend on.



RollMatic roller garage doors for generations

Endurance tests under real conditions ensure mature series products with Hörmann quality. Thanks to this, excellent technical solutions and uncompromising quality assurance, you receive a 10-year warranty on all RollMatic roller garage doors and 5 years on all Hörmann operators.



An eye on the future

Hörmann is setting a good example. This is why, since 2013 the company has obtained up to 40 % of its required energy from green sources and will continue to increase this percentage. At the same time, many tonnes of CO₂ are saved each year thanks to the introduction of an intelligent and certified energy management system. And last but not least, Hörmann also offers products for sustainable construction. Find out more about Hörmann’s environmental activities in the “We think green” brochure.

* The complete warranty conditions can be found at: www.hoermann.com

Good reasons for a roller garage door

Convincing in terms of function and appearance

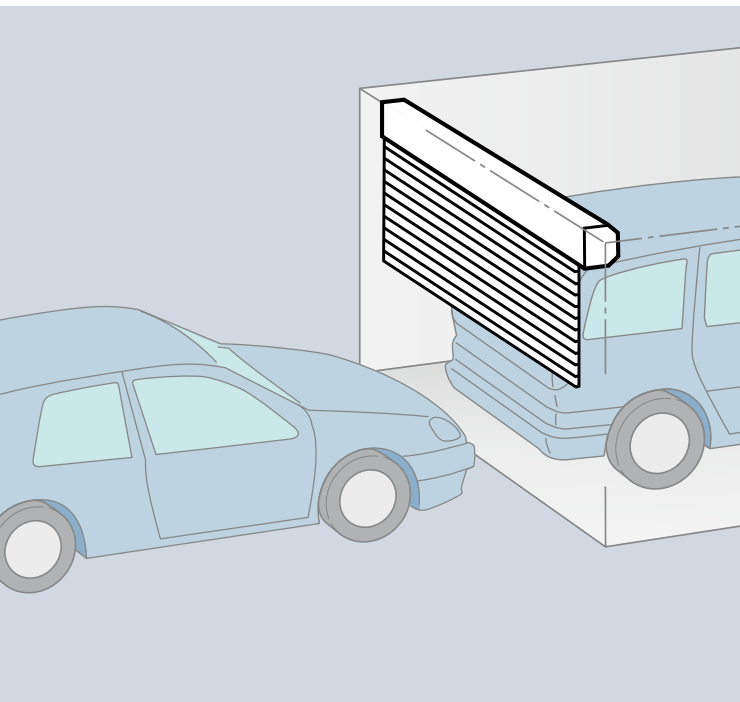

Maximum space in front of and in the garage

Space-saving design

RollMatic roller garage doors open vertically and require minimum space inside the garage. The door's design offers maximum space inside and in front of the garage.

The ceiling also remains free and can be used for lamps or as an additional storage space.

Ideal for modernisation

The shape of the garage door opening doesn't play a role with roller garage doors. A Hörmann RollMatic fits anywhere, no matter whether your garage opening is rectangular or chamfered, or has a segmental or a Norman arch.

A Hörmann sectional door always fits.

External roller garage doors with a lack of interior sideroom

Fitting in front of the opening

The RollMatic is also available as an external roller garage door for fitting in front of the opening if your garage has little lintel space and/or sideroom.

The external roller garage door is supplied as a complete package with a matching operator. The shaft cover around the operator protects it from adverse weather effects and unauthorised interference.

The barrel cover and frame come in the same colour as the door to create a uniform and harmonious appearance.

The tension spring cover on the sides of the external roller garage door is made of aluminium and features vision sections to control the spring system.

Good reasons to try Hörmann

The market leader for construction components has all the innovations



1

Reliable and safe: the tension spring assembly

Convincing technology

The tested tension spring assembly supports the operator during the opening and closing of the door. This protects the operator mechanism and in case of an emergency, the door can be easily opened by hand. A crank handle is not necessary. Double cabling additionally protects the door from crashing to the floor.

The special profile arrangement at the shaft guarantees a secure, break-in resistant locking. With this mechanism, it is practically impossible to push the curtain open.

2

Maintenance-friendly and especially silent

Operator included as standard

The operator is located outside the shaft cover for trouble-free maintenance. The start and stop of the RollMatic door are particularly soft and silent, preserving the door. The spring compensation and reliable automatic cut-out render an additional closing edge safety device unnecessary. An internal push button and light are already integrated in the control housing.

Roller garage door RollMatic

A complete package with a matching operator



RollMatic roller garage doors can be individually adapted to the architecture of your home or the fitting situation in the garage. Select from one of 11 equally-priced colours for an individual door. Matching side doors are also available. An external rolling shutter is recommended for fitting situations with little lintel space. You can always find a perfect solution with a RollMatic roller garage door.

Colours and surface finishes

You can choose between 11 equally-priced colours and two attractive Decograin or Decopaint surfaces each.

Further information can be found on pages 9 – 11

Matching side door

A practical side door is a convenient way to access your garage. Matching the RollMatic, side doors are supplied with a slim corner frame in the same design as the side doors for up-and-over garage doors.

External rolling shutter

A RollMatic external roller garage door for fitting in front of the opening is the right solution for garages with low headroom and/or sideroom. The external roller garage door is always supplied as a complete package with a matching operator.

Further information can be found on page 14



Roller garage door in Anthracite grey, RAL 7016



Roller garage door in White aluminium, RAL 9006 with matching side door



External rolling shutter in Traffic white, RAL 9016

Surface finishes and colours

For individual design possibilities

Smooth surface

The smooth surface of the aluminium profiles looks modern and elegant, unlike ribbed profiles from other suppliers. Furthermore, a high-quality coating on the inside and outside of the door's surface makes it easy to clean.

Profile with thermal insulation

The hollow space of the profile is evenly filled with polyurethane rigid foam for quiet door travel.

Glazing elements

Get more daylight in your garage! The glazing elements with synthetic panes are arranged across the entire profile width. The number of elements depends on the respective door width. A maximum of ten profiles can be fitted with glazings in each door.

Ventilation grilles

Ventilation of your garage improves the room climate and prevents mould. Ventilation grilles made of long-lasting plastic are arranged across the entire profile width. A maximum of ten profiles can be used for each door.



Profile view
Interior

Profile view
Exterior



Profile with
synthetic glazing

Profile with
ventilation grille



All colours based on RAL.

The colours and surfaces shown are subject to the limitations of the printing process and cannot be regarded as binding. Please consult with your local Hörmann specialised dealer.

11 equally-priced colours

RollMatic roller garage doors from Hörmann are delivered in Traffic white as standard, in addition there are 10 preferred colours available without a surcharge.

	
Traffic white	RAL 9016
	
White aluminium	RAL 9006
	
Jet black	RAL 9005
	
Cream	RAL 9001
	
Terra brown	RAL 8028
	
Light grey	RAL 7035
	
Anthracite grey	RAL 7016
	
Moss green	RAL 6005
	
Steel blue	RAL 5011
	
Ruby red	RAL 3003
	
Light ivory	RAL 1015



Harmonious overall appearance

Only Hörmann offers you the complete door in the selected door colour without a surcharge. The door curtain, guide rails, fascia panel, and shaft cover are thus combined in an attractive and harmonious unit.

Decor surface finishes

In natural timber looks

Decograin surface finishes

The two Decograin surfaces in the colours Golden Oak and Rosewood have a convincingly real timber look. A special wear-resistant surface protection preserves the UV-resistant plastic film coating on the RollMatic over a long time.

To create a uniform appearance, the exterior door curtain, fascia and frame are supplied with a Decograin surface finish. The interior fascia, side guides, barrel casing and door curtain are painted in brown.

Decograin surface finishes are not available for external rolling shutters.

Decopaint surface finishes *// NEW*

The Decopaint surface finishes Golden Oak and Rosewood are an affordable alternative to Decograin decors.

The interior and exterior of the profiles are painted to look like timber.

Frames, side guides, fascia panels and shaft covers are powder-coated in a base colour matching the timber to create a harmonious appearance.



Side guide in base colour Golden Oak



Side guide in base colour Rosewood



Interior profile view
in brown

Exterior profile view
in Decograin Golden Oak



Interior profile view
in Decopaint Golden Oak

Exterior profile view
in Decopaint Golden Oak



Decograin decors



Golden Oak



Rosewood

Decopaint decors



Golden Oak



Rosewood

Convincing technology

Details perfectly matched to each other



Easy to fit

RollMatic roller garage doors are quickly and simply fitted. The side guides, lintel bracket and operator are bolted to the garage walls and lintel. Subsequently, the curtain is connected to the shaft using belts, pulled onto the shaft by the operator and fixed. There is no need for extensive adjustment.

Tension spring assembly with multi-spring system

[1] Hörmann RollMatic roller garage doors with double tension springs and double cabling protect the door leaf from crashing in every door position. The patented multi-spring system and the transparent protective cover prevent broken springs from flying out and thus protect from personal injury.

A well-protected shaft

[2] The standard shaft cover practically prevents reaching into the door barrel. In addition, it protects the curtain from damage and dirt when the door is open. The cover is supplied in the colour of the door or in brown with Decograin surfaces.

Integrated mechanical anti-lift kit

[3] The special section positioning at the shaft as well as the connection to the operator protect the RollMatic roller garage door from being pushed open forcefully from the outside. This makes burglary attempts much more difficult. Of course, manual opening from the inside is possible in emergencies.

Wear-resistant bearing rings

[4] The newly developed bearing rings made of various plastics reduce wear when the curtain is rolled up and down. This keeps the surface of the door curtain beautiful for a long period of time. The bearing rings also dampen noise and help the door to close better.

Standard wind locks

[5] Hörmann's RollMatic roller garage doors can even withstand large wind loads (up to class 5). The wind locks fitted as standard in the profile ends keep the door securely within its guides. An additional advantage is increased protection from burglary.



External roller garage door RollMatic

The solution for areas with a lack of interior sideroom



Variable operator positions

[1] Depending on the fitting situation, operators for external roller garage doors can either be installed on the left or right. The shaft cover is 100 mm wider in this area and encloses the operator, protecting it from adverse weather effects or from unauthorised interference.



Tension spring cladding with vision sections

[2] You can easily check whether the cable guide or springs are working through the vision sections in the spring cladding, providing you with safety even after many years.

Secured release on inside

[3] The operator can be easily released from the inside using a hand pulley. You can, for example, easily open your door by hand from the inside during a power failure.



Variants and optional extras

The right solution for every application

Manually operated door

Easy manual opening

Thanks to the supporting tension spring compensation, Hörmann roller garage doors are easy to manually open and close from the outside of the garage using the handle [1] and from the inside with the pull chain.

Manual door locking

The manually operated roller garage door is mechanically locked using interior and exterior handles and a lock. Solid metal bolts extend on the right and left into the door frame.



Chamfered bottom profile

The solution for sloping ground: An aluminium chamfered bottom weather seal compensates for differences in height over the entire door width of up to 300 mm. The profile can be fitted without any difficulty and is simply screwed onto the inserted curtain.

The bottom profile is delivered powder-coated in Jet black (similar to RAL 9005). On request, the bottom profile (as shown) is also available in a colour matching the door colour.



Additional fascia panel

The additional fascia panel [3] stabilises the fascia panel during fitting in the opening or behind the opening, if the fascia panel can be seen in the opening. It harmoniously covers the lintel without any unattractive fitting holes. The additional fascia panel is available in the colour of the door or with a Decograin surface.

Fitting compensation set

The standard compensation set [4] ensures flush-fitting installation of the door in uneven walls. For more information, consult the technical manual.



Hörmann BiSecur

A modern radio system for your home

Only from Hörmann



Tested and certified

The newly developed, extremely secure BiSecur encryption protocol makes sure that no-one can copy your radio signal. It has been tested and certified by security experts at the Bochum University and has the same high security level as online banking.

Award-winning design

The exclusive BiSecur hand transmitters are set apart by their high-gloss surface in a piano lacquer look, as well as by an elegant shape that fits easily in the palm of your hand. The figure on the left shows an HS 4 BS hand transmitter with hand transmitter station (optional).

Hörmann's BiSecur hand transmitters have been awarded a design prize by an international jury.



reddot design award
honourable mention 2011



Please see the following pages for more information on the hand transmitters and other control elements. The complete range of accessories can be found in Hörmann's specialised brochure on garage door and entrance gate operators and at www.hoermann.com.

Door, operator and control

An optimally matched system



Approved as a functioning unit

In RollMatic roller garage doors, the door components, operator and control are optimally adjusted to each other and approved as a functioning unit.

The integrated soft start and soft stop of the operator ensures smooth door travel and protects the door. The accessible operator housing facilitates easy maintenance.

The control is complete and equipped with a button and a light.

Standard emergency release

Standard emergency release via a pull cord: The door can be easily pushed open after pulling the cord and does not have to be cranked open.

Reliable automatic safety cut-out

The automatic safety cut-out secures the closing edge and immediately stops the door if there is an obstacle. This way an additional closing edge safety device can be omitted.

As standard:

- Impulse control with integrated lighting
- X 2 HSE 2 BS hand transmitters
- Automatic safety cut-out with obstacle detection
- Emergency release from the inside via a pull cord
- Mechanical anti-lift kit
- Safety catch with tension spring assembly



Standard 2-button hand transmitter
HSE 2 BS (textured surface)



On encountering an obstruction, the automatic safety cut-out stops the door

Security can look this beautiful

Hörmann BiSecur hand transmitters and switches



**Hand transmitter
HS 4 BS**
4 button functions,
[1] high-gloss black

**Hand transmitter
HS 1 BS**
1 button function,
[2] high-gloss black

**Hand transmitter
HSE 1 BS // NEW**
1 button function
incl. eyelet for key ring
[3] High-gloss black



**Hand transmitter
HSE 2 BS // NEW**
2 button functions,
incl. eyelet for key ring
[4] High-gloss black or white
[5] High-gloss green, purple,
yellow, red, orange
(Fig. from left)

[6] Black textured surface
with chrome or plastic caps
[7] Decors in silver, carbon,
light rootwood, light timber,
dark timber, dark rootwood
(Fig. from left)



Quality accessories for added security



Hand transmitter HSD 2-A BS

Aluminium look,
2 button functions,
can also be used as a key ring

HSD 2-C BS

High-gloss chrome,
2 button functions,
can also be used as a key ring



Hand transmitter HSP 4 BS

4 button functions,
with button lock-out,
incl. key ring



Hand transmitter HSZ 1 BS

1 button function,
for insertion in vehicle
cigarette lighter

HSZ 2 BS

2 button functions,
for insertion in vehicle
cigarette lighter



Radio code switch FCT 10 BS

For 10 functions,
with illuminated buttons
and protective cover



Radio finger-scan FFL 12 BS

For 2 functions
and up to 12 finger prints



Optional emergency release from the outside

For garages without a second access, we offer you
the option of opening the door from the outside
in case of emergency (e.g. power failure).



Acoustic alarm

To complement the mechanical anti-lift kit, Hörmann
optionally offers you an acoustic alarm. The shrill alarm
sound with a volume of 110 dB (A), equal to a siren
10 m away, effectively deters burglars.



The emergency battery

With this emergency power supply, you can bypass
network power failures for up to 18 hours and max.
5 door cycles. The emergency battery recharges itself
during normal operation.



Roller garage door fitting dimensions

RollMatic roller garage door incl. operator

Internal roller garage door: Fitting behind the opening, view of fitting side

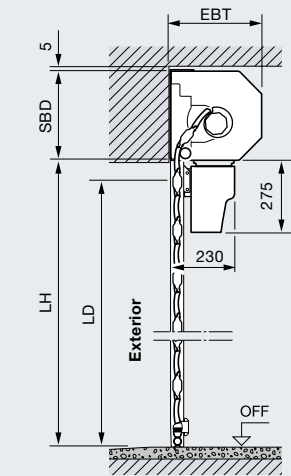
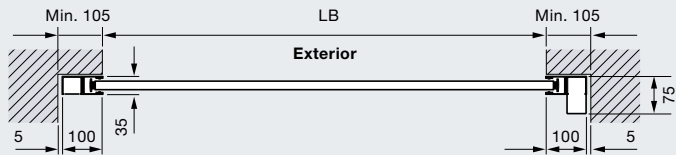
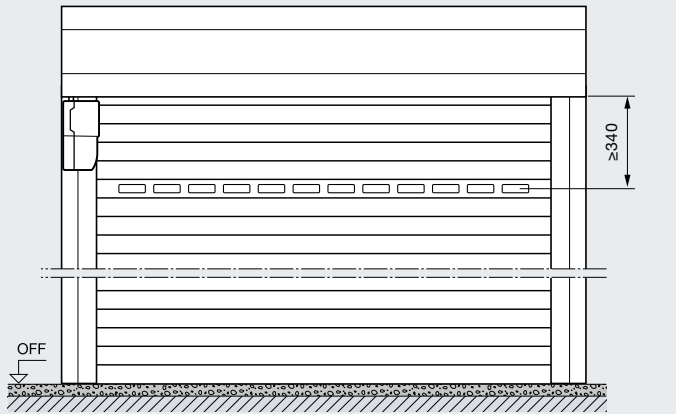

Internal roller garage door: Fitting in the opening, interior view

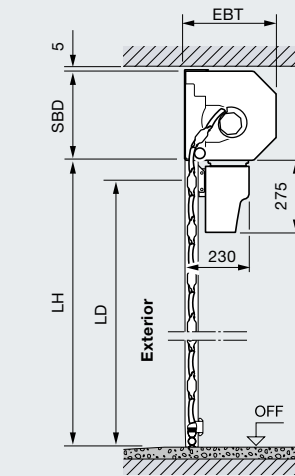
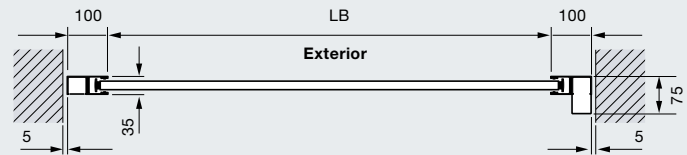
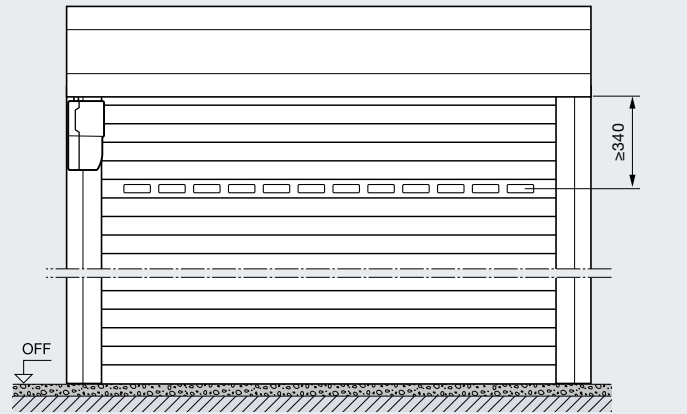

Size range for internal and external roller garage door

3100																				
3000																				
2875																				
2750																				
2675																				
2625																				
2500																				
2375																				
2250																				
2125																				
2000																				
1800																				
1600																				
	1000	1250	1500	1750	1900	2000	2250	2500	2750	3000	3250	3500	3750	4000	4250	4500	4750	5000		

Clear width (LB)

External roller garage door: Fitting in front of the opening, view of fitting side

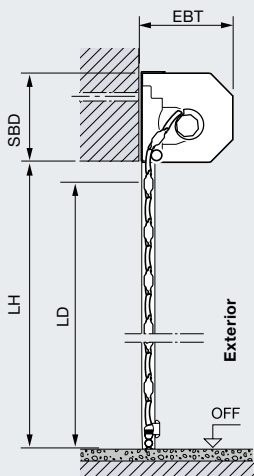
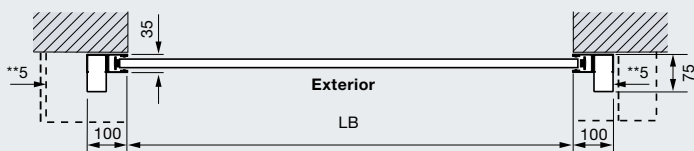
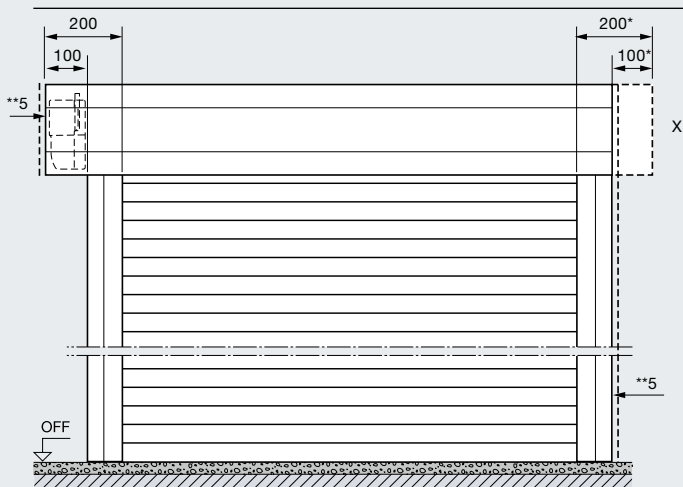

Explanation of dimensions

- LB Clear width = ordering size
- LH Clear height = ordering size
- LD Clear passage
- EBT Fitting depth
- SBD Required headroom

Fitting depth EBT

- Up to 2300 mm door height 290 mm
- From 2301 mm door height 335 mm

Required headroom SBD

- Up to 2300 mm door height 290 mm
- From 2301 mm door height 335 mm

Clear passage LD

- Height (with operator) LH - 60 mm
- Height (manually operated) LH - 125 mm
- Width LB

Side space requirement

- 100 mm
- External roller garage door operator side 200 mm

Wind load classes

- Up to door widths of 3500 mm Class 5
- Up to door widths of 4500 mm Class 4
- Up to door widths of 5000 mm Class 3

X External roller garage door cladding

A symmetrical arrangement is also possible, in addition to a variable operator position (as standard on the left, optionally on the right) with projection of the shaft cover on the operator side.

* For a visually balanced look the barrel casing can be ordered symmetrically!

** At least 5 mm distance from fascia panel / side guide

Side door fitting dimensions

Roller garage door RollMatic

Position of anchors

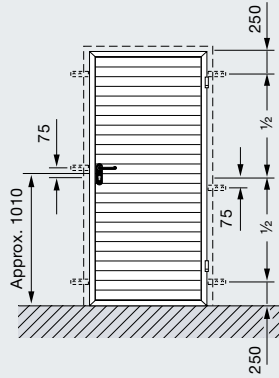

Single-leaf with threshold

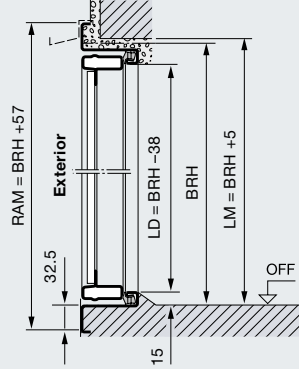

Explanation of dimensions

- RAM Overall frame dimension
- BRB Nominal size width
- BRH Nominal size height
- LM Structural opening
- LD Clear passage

Single-leaf without threshold

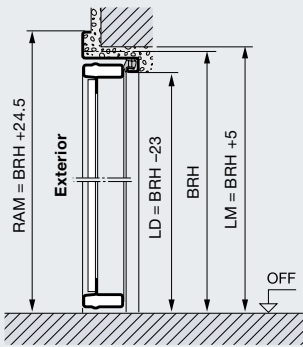

Single-leaf with threshold

(the threshold is removed on-site)

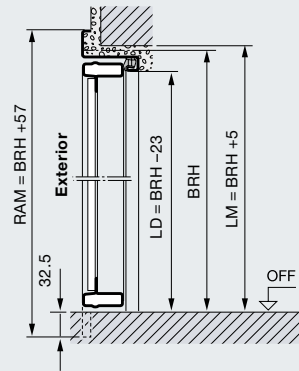

External fitting opening outwards

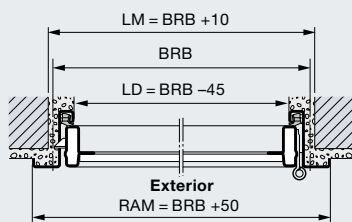

Internal fitting opening inwards

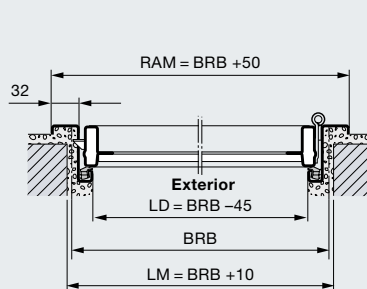

Material

Door frame and frame made of galvanized material, polyester powder-coated primer on both sides, with roller garage door section infill in RollMatic style. Position of sections does not match the RollMatic roller garage door. Glazing and ventilation grilles arranged as in the RollMatic roller garage door.

Experience Hörmann quality

For every application involving new construction and modernisation

Hörmann provides an excellent basis for comprehensive planning. Carefully matched solutions offer you the very best in perfectly designed products for every area.

Garage doors

Optimally match your personal architectural style: up-and-over or sectional doors made of steel, grp or timber.

Door operators

Enjoy extra convenience and break-in-resistant security: Hörmann operators for garage doors and entrance gates.

Entrance doors

Our comprehensive entrance door ranges include models that fit almost every need and requirement.

Steel doors

Sturdy doors for your entire home, from basement to roof.

Frames

Choose from our comprehensive range of products for new construction, expansion and modernisation.



Garage doors and entrance gate operators



ThermoPro entrance door

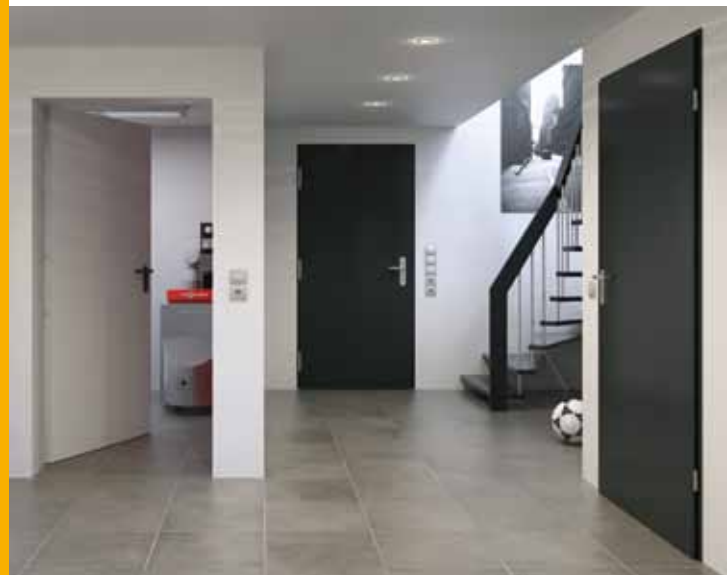

Steel doors

Hörmann: Quality without Compromise



Hörmann KG Amshausen, Germany



Hörmann KG Antriebstechnik, Germany



Hörmann KG Brandis, Germany



Hörmann KG Brockhagen, Germany



Hörmann KG Dissen, Germany



Hörmann KG Eckelhausen, Germany



Hörmann KG Freisen, Germany



Hörmann KG Ichtshausen, Germany



Hörmann KG Werne, Germany



Hörmann Genk NV, Belgium



Hörmann Alkmaar B.V., Netherlands



Hörmann Legnica Sp. z o.o., Poland



Hörmann Beijing, China



Hörmann Tianjin, China



Hörmann LLC, Montgomery IL, USA



Hörmann Flexon LLC, Burgettstown PA, USA

Hörmann is the only manufacturer worldwide that offers you a complete range of all major building products from one source. We manufacture in highly-specialised factories using the latest production technologies. The close-meshed network of sales and service companies throughout Europe, and activities in the USA and China, make Hörmann your strong partner for first-class building products, offering “Quality without Compromise”.

GARAGE DOORS
OPERATORS
INDUSTRIAL DOORS
LOADING EQUIPMENT
HINGED DOORS
DOOR FRAMES

