



APLUS
The system for
heavy-current analysis

One device – A variety of functions

The *APLUS* is a powerful platform for measuring, monitoring and analyzing power systems. The focus is on highest Swiss quality and maximum customer benefit.

This universal measurement device can be easily integrated into the process environment on site. It provides a wide functionality, which may be further extended by means of optional components.

The connection of the process environment may be performed by means of the communication interface, via digital I/Os or via analog outputs.

Application

The *APLUS* is designed for applications in power distribution, in strongly distorted industrial environments and in building automation. Nominal voltages up to 690 V can directly be connected.

The *APLUS* is the ideal device for demanding measurement tasks where fast, accurate and insensitive analysis of power systems or loads is required. In addition it can also replace fault or limit monitoring devices, small control systems and summation stations of energy management systems.

System state acquisition

- High updating rate
- Precise and uninterrupted
- For any power systems

Monitoring unit

- Universal analysis of limit values
- Combination of limit values
- Analysis of internal / external states

Remote control and maintenance

- Remote I/O
- Remote data acquisition and parameterization
- Changeover local/remote operation

Universal process I/O

- State, pulse and synchronization inputs
- State and pulse outputs
- Relay outputs
- Analog outputs ± 20 mA

Energy management

- Active and reactive meters
- Load profiles, load curves
- Trend analysis
- Variance of system load
- Connection of external meters



Open communication

- Free definable process image
- Modbus/RTU via RS485
- Modbus/TCP via Ethernet
- Profibus DP up to 12 Mbaud

Data display

- Measurements and meters
- Limit states
- Plain text alarming
- Alarm acknowledge and reset
- Free configurable display

Monitoring operating resources

- Operating times
- Service intervals
- Durations of overload situations
- Operation feedbacks

Long-term data storage

- Measurement progressions
- Disturbance information
- Events/alarms/system events
- Automatic meter readings

Power quality analysis

- Harmonic analysis
- Extended reactive power analysis
- Variance of short/long term load
- Power system imbalance
- Nominal condition monitoring

The measurement system

The APLUS can be adapted fast and easily to the measurement task by means of the CB-Manager software. The universal measurement system of the device may be used directly for any system, from single phase up to 4-wire unbalanced networks, without hardware modifications. Independent of measurement task and outer influences always the same high performance is achieved.

The measurement is performed uninterrupted in all four quadrants and can be adapted to the system to monitor in an optimal way. The measurement time as well as the expected system load can be parameterized.

The device can provide more than 1100 different measured quantities, which may be grouped as follows:

Measured quantities	Measurement uncertainty
Voltage, current	± 0.1%
Power, imbalance	± 0.2%
Harmonics, THD, TDD	± 0.5%
Frequency	± 0.01Hz
Load factors	± 0.1°
Active energy	Cl. 0.5S (EN 62 053-22)
Reactive energy	Cl. 2 (EN 62 053-23)

Overview of APLUS measurement uncertainty

Measurement group	Refreshing interval	Application
Instantaneous values	Configurable measurement interval (2...1024 cycles)	<ul style="list-style-type: none"> Monitoring present system state Unbalance monitoring Earth fault monitoring
Harmonic analysis	Approx. 2 times per second, depending on system frequency	<ul style="list-style-type: none"> Rating the thermal load of resources Analysis of system feedback and load structure
Extended reactive power analysis		<ul style="list-style-type: none"> Reactive power compensation
Voltage/current imbalance		<ul style="list-style-type: none"> Protection of operating resources Earth fault monitoring
Energy meters	Same as measurement interval	<ul style="list-style-type: none"> Billing purposes Energy efficiency monitoring Summation of external meter pulses
Power mean-values	Configurable, 1s...60 min	<ul style="list-style-type: none"> Load profiling for energy management
User-defined mean value quantities		<ul style="list-style-type: none"> Short-term fluctuations

Parameterization, service and measurement acquisition

The supplied **CB-Manager** software provides the following functions to the user:

- Complete parameterization of the APLUS (also offline)
- Acquisition and recording of measured quantities
- Archiving of configuration and measurement files
- Setting or resetting of meter contents
- Selective reset of extreme values
- Setting of interface parameters
- Simulation of logic module or outputs functions
- Comprehensive help system

A security system can be activated to restrict the access to device data. This way e.g. changing a limit value via display can be locked, but a setting via configuration could still be possible.

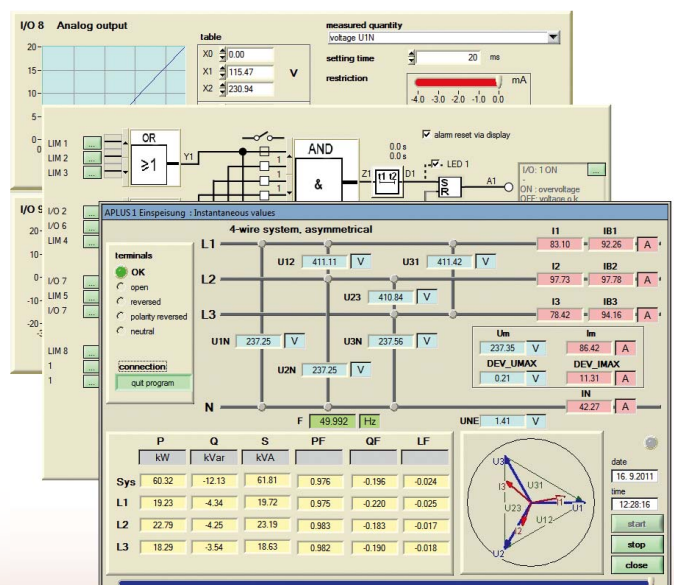

Energy management

The *APLUS* provides all functions needed to collect fast and efficient load data for an energy management system. A system composed of *APLUS* devices promises maximum accuracy and highest performance for each individual measurement point when used in power distributions. It can satisfy the following basic requirements:

- Recording load curves (Energy consumption over time)
- Acquisition of energy consumption summaries
- Automatic meter readings (calendric)
- Peak-load monitoring
- Trend analysis of present demand
- Load switch-off to prevent penalties

An energy optimization system can be composed of one device only and connecting already installed meters to it. The *APLUS* monitors then for example the main incoming supply and serves as well as a data summator station, which not only accumulates the contents of up to 7 meters of any kind of energy, but from the corresponding pulse rate can also derive their course in time – the load curve.

The collected energy data can also be recorded for years by means of the optional data logger. For the tabular or graphical analysis of these data the *CB-Analyzer* software is provided, which is in the scope of supply. This software collects data via Ethernet and stores them in a data base.

The sum of all these measures allows to achieve the following topics:

- Optimization of internal operating procedures
- Reduction of the total energy consumption
- Peak-load reduction

The cost savings achieved this way not only increases the profitability of the own company but also its competitiveness.

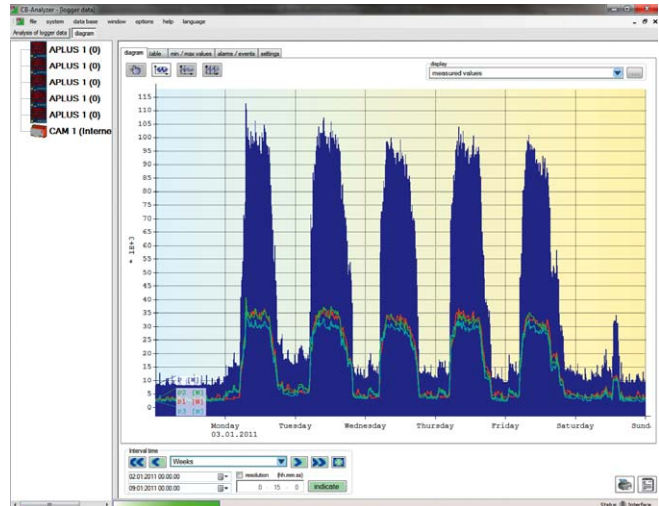

Load profile analysis using the *CB-Analyzer* software

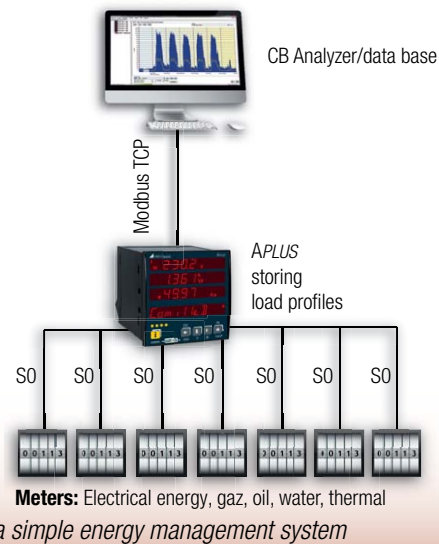

Example of a simple energy management system

Data analysis using the *CB-Analyzer*

The supplied *CB-Analyzer* software allows to read and analyze the data of the *APLUS* data logger. It provides the following functions to the user:

- Reading logger data (load curves, meter readings, min/max-courses, event lists, disturbance recordings)
- Data storage in a data base (Access, SQLClient)
- Graphical analysis of collected data
- Concurrent analysis of multiple devices
- Report generation in form of lists or graphics
- Selectable time range in report preparation
- Export of report data as Excel, PDF or WORD file

The *CB-Analyzer* software provides a comprehensive help functionality, which describes in detail the operation of the software.

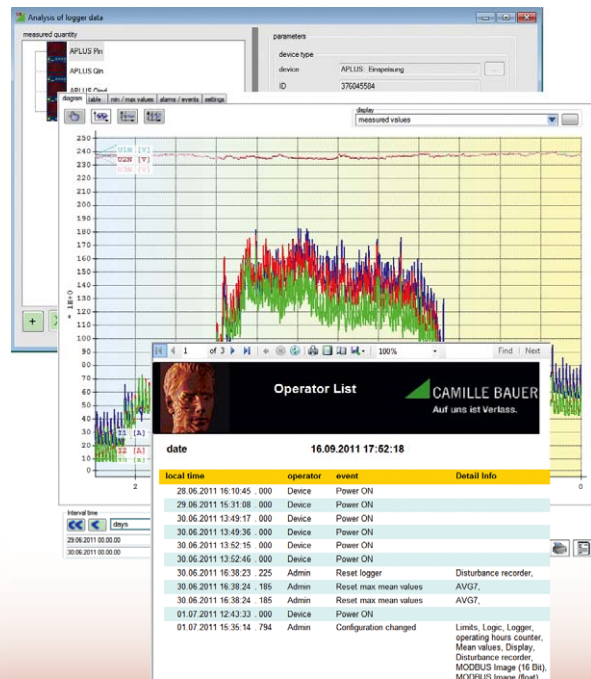

Power quality analysis instead of failure analysis

In the world of standards the quality of a grid is defined using statistical deviations from a desired standard behaviour. But what's really needed when monitoring power quality is a statement if the used operating resources will work undisturbed under the real existing conditions.

The *APLUS* therefore does not work with statistics, but examines the real environment, to allow performing a corresponding immunity analysis. Almost all important aspects of power quality can be investigated and interpreted.

Variation of the system load

The absolute minimum/maximum values with timestamp are available for instantaneous and mean values. They indicate the bandwidth of the variations of the system parameters.

Using the extreme value data logger also short-term variations within an interval can be acquired. This way e.g. a load profile can be recorded, where along with the mean power also the highest and lowest short-term demand will be shown.

Additional load by harmonics

Harmonics originate from non-linear loads in the grid - a homemade pollution most of the time. They may induce an additional thermal stress to operational resources or cables and disturb the operation of sensitive loads.

The *APLUS* shows the harmonic contents of currents as Total Demand Distortion, briefly TDD. This value is scaled to the rated current resp. rated power. Only this way its influence on the connected equipment can be estimated correctly. In industrial grids the image of the harmonics often allows to determine quite good what types of loads are connected to the system.

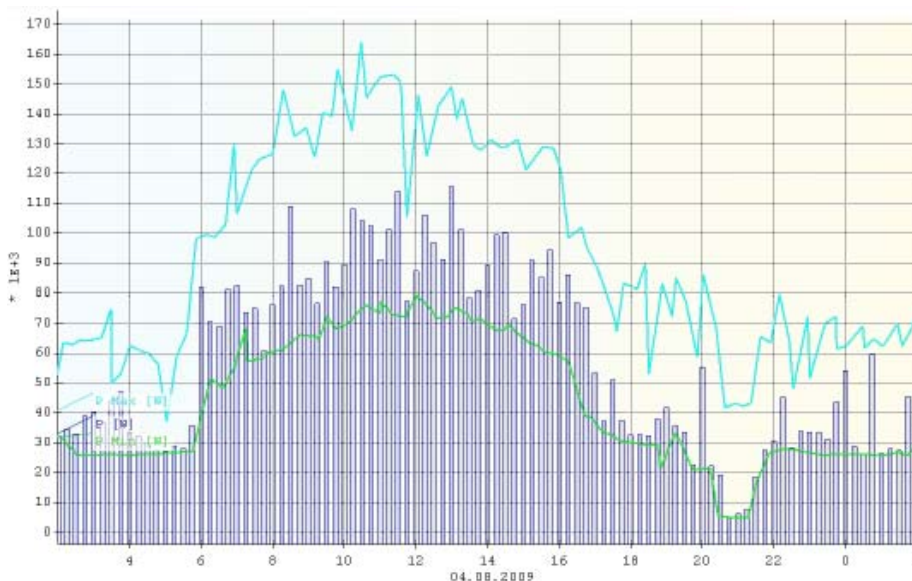
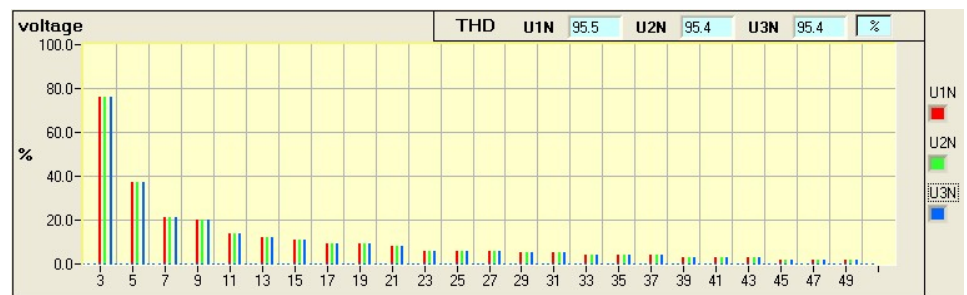

System imbalance

System imbalance not only occurs due to single phase load situations, but is often a sign for disturbances in the grid, such as isolation failure, phase failure or earth-leakage. Three phase loads are often very sensitive to operating voltages provided imbalanced. This may lead to a shorter lifetime or even damage.

An imbalance monitoring therefore not only helps to save costs in maintenance but also prolongs the undisturbed operating time of the used production facilities.

Hint: The accuracy of the harmonic analysis depends strongly on the quality of the current and voltage transformers possibly used, because harmonics are normally heavily distorted. It's valid: The higher the frequency of the harmonic, the higher its damping.

Violations of limit values

Important parameters, such as imbalance, should be checked continuously to protect important operating resources, by separating them from the grid in better time.

In association with the data logger violations of limit values may be recorded with the time of their occurrences.

Fundamental and distortion reactive power

The reactive power may be divided in a fundamental and a distortion component. Only the fundamental reactive power may be compensated using the classical capacitive method. The distortion component, which originate from harmonic currents, have to be combated using inductors or active harmonic conditioners.

Rectifiers, inverters and frequency converters are only a few examples of components generating distortion reactive power. But normally only in industrial grids it may represent a real problem.

Operating behavior monitoring

Monitoring service intervals

Many operating resources must be maintained regularly. Their service intervals often depend also on the prevailing operating conditions. For monitoring these intervals three operating hour counters are provided, which by means of limit values, digital feedback signals or a suitable combination of the same may be used to determine the

- loads operating time under normal conditions
- loads operating time under overload conditions

Another operating hour counter is used to measure the time the APLUS itself has been switched on.

Protection of operating resources

To prevent malfunction or failure of equipment, such as generators, motors, heaters, cooling or computer systems, the permissible operating conditions are often tightly restricted. In order to protect such resources effectively you therefore have to examine if certain system quantities remain within the allowed range. For that quite often a combination of multiple limit values is necessary.

Universal logic analysis

The logic module shown below provides both the monitoring of service intervals and the effective protection of resources. This is achieved by logically combining the states of limit values, logic inputs and bus controlled information. Alarming and event or disturbance recordings are provided as possible actions.

Here is a selection of possible applications for the logic module:

- Functions of protective relays (e.g. over-current, phase failure or imbalance)
- Changeover of the present operating mode, such as e.g. local/remote (day/night) operation
- Controlling the recording of alarms, events and acknowledgment procedures
- Monitoring of external devices, such as circuit states or self monitoring signals

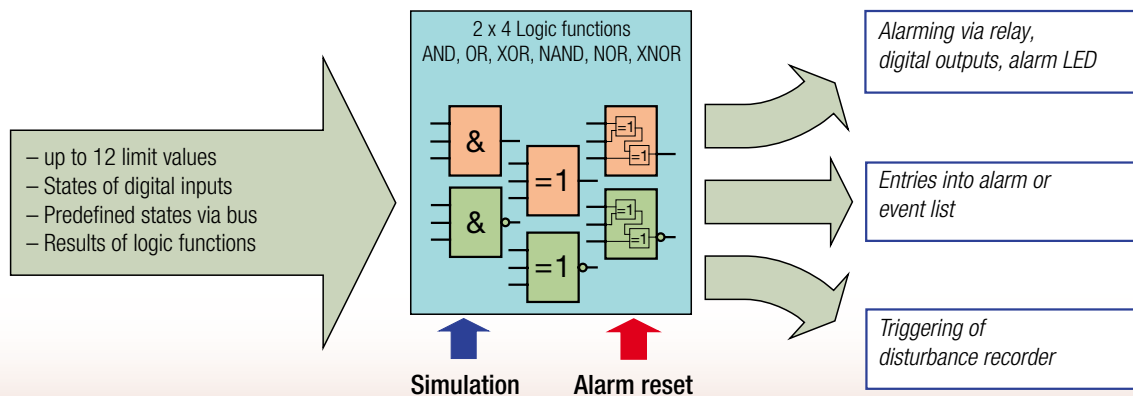

Long-term data storage with the data logger

The optional data logger offers the potential to record the behavior of a power system or load as well as the occurrence of definable events over a long period of time. Thus, for example, the following information may be collected:

- Consumption data for energy management
- Data about applied load for system expansion planning
- Measurement flows for incident analysis
- Recorded process flow

The data logger consists of data either recorded periodically or event-driven:

- Mean-values (power or user-definable quantities)
- Min/max values (RMS values within an interval)
- Meter readings, in calendric intervals
- Operator, alarm and event lists
- Disturbance records (RMS curves)

The storage medium used is an SD card, which allows virtually unlimited recording times and may be easily replaced in the field.

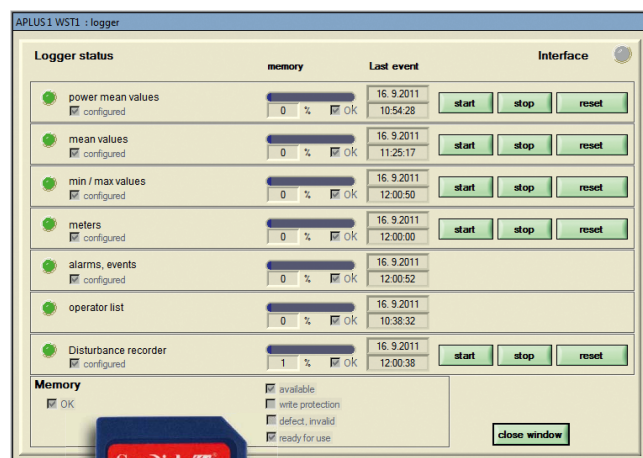

THE DISPLAY

The optional display of the APLUS offers everything what is demanded of an indicating device:

- Excellent readability, even from a distance and almost every angle
- Clear and explicit display of measured data
- Free composition of measurement displays
- Free allocation of alarms to status LED's
- Free definable plaintext display for alarming
- Preference display and roll mode



Operating the display is performed using multi-function keys. Their functionality depends on the active operating mode and the time a key is pressed.

MEASUREMENT DISPLAY-MODES

The measurement display can be optimally tailored to the needs of the user. Depending on the information needs you may select one from the following four display modes:

FULL: All measurement displays in a matrix representation, selected via arrow keys. Fourth line used for meter display.

REDUCED: Same as FULL mode but with facility to hide individual measurement displays.

USER: Up to 20 free composable measurement displays, selected with  and . The fourth line may be used to display meter contents or a power, voltage or current quantity.

LOOP: Measurement displays of the USER mode will be displayed successively for a definable time.

PROGRAMMING MENU

Via the programming menu of the device the following device parameters may be changed

- Type of system
- Voltage and current transformer ratios
- Parameters of the interfaces Modbus, Profibus or Ethernet
- Limit value thresholds
- Time and date
- Parameters of the display

A full parameterization of all functions of the device can be performed using the CB-Manager software only.

During operation the following settings may be performed:

- Changing the measurement display mode
- Selectively reset of min/max values
- Selectively reset of meter values

SECURITY SYSTEM

All programming functions may be locked selectively by means of the PC software. They then are not at the user's disposal when operating the display unit.

Also for the access via programming interface the alteration of device data may be granted or locked per group.

OPERATING DISPLAY MODES

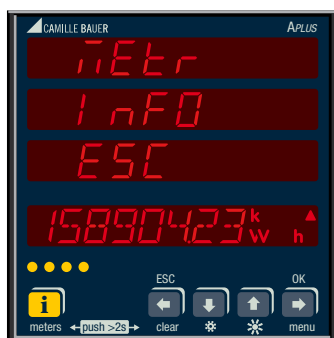

Meter reading mode

To read the contents of up to 38 meters you have to press the info button for a long time (>2s) and then you may scroll through the values using the arrow keys. When changing the displayed meter content the abbreviation of the meter newly to display will be shown first.

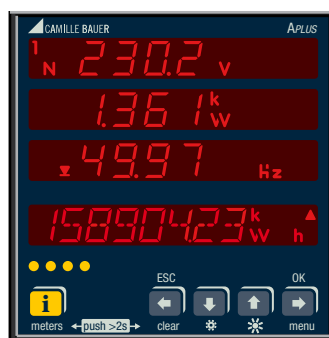

Measurement display mode

In accordance with the selected measurement display mode the measured values are displayed on four lines. When changing the measurement image by means of the arrow keys, for a short time the abbreviation of the measurements is shown first before the new values will be displayed.



Alarm display mode

Occurring alarms are displayed via the yellow LEDs. After pressing the info button on line 4 the user-defined text of the first active alarm is displayed. Active alarms can be acknowledged and induced actions (e.g. the switching of a relay) may be reset.

Meter reading and alarm display mode will be finished using the key ESC, or automatically after 30s.

Free composition of the required functions

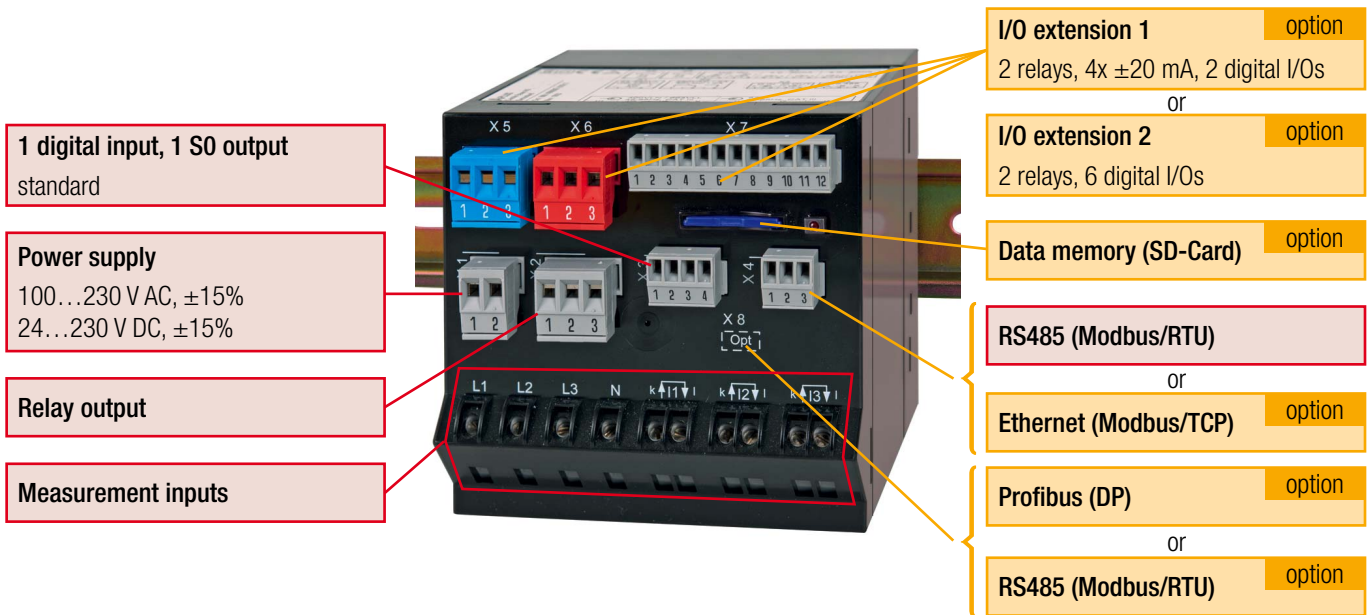

Possible application of the I/Os

Relay outputs

- Alarming via lamp or horn
- Load shedding
- Remote controllable via bus interface

Digital outputs ¹⁾

- Alarm output of the logic module
- State reporting
- Pulse output to external counters (acc. EN62053-31)
- Remote controllable via bus interface

Analog outputs

- Connection to PLC or another measurement system (e.g. CAM).
- All outputs are bipolar (± 20 mA) and galvanically isolated

Digital inputs ¹⁾

- Operating feedback of loads for operating hour counters
- Trigger and release signal for logic module
- Pulse input for any meter
- Meter tariff switching
- Synchronization (clock or mean-value intervals)

¹⁾ The digital I/Os of the I/O extensions can individually be configured for input or output.

Order code **APLUS** -

1. Basic unit APLUS	
Without display, for top-hat rail mounting	0
With LED display, for panel mounting	1
2. Input / frequency range	
Current transformer inputs, 45...50/60...65Hz	1
Rogowski current inputs, 45...50/60...65Hz	2
3. Power supply	
Nominal input voltage 24...230 V DC, 100...230 V AC	1
4. Communication interface	
RS485, protocol Modbus/RTU	1
Ethernet, protocol Modbus/TCP, NTP	2
RS485 (Modbus/RTU) + Profibus DP ²⁾	3
RS485 (Modbus/RTU) + RS485 (Modbus/RTU)	4
Ethernet (Modbus/TCP) + RS485 (Modbus/RTU)	5
5. I/O extension	
Without	0
2 relays, 4 analog outputs ± 20 mA, 2 digital I/Os	1
2 relays, 6 digital I/Os	2

6. Test certificate	
Without	0
Test certificate in German	D
Test certificate in English	E
7. Data logger	
Without data logger	0
With data logger ²⁾	1

Accessories	Order no.
Rogowski current sensor, single-phase, ACF3000_4/24	172 718
Doku-CD, Profibus-CD ³⁾	156 027
Connecting set 1 (plug-in terminals, mounting bracket) ³⁾	168 220
Connecting set 2 (plug-in terminals I/O extension) ³⁾	168 238
Interface converter USB <> RS485	163 189

²⁾ Data logger can not be combined with Profibus DP interface

³⁾ Scope of supply

Technical data

Inputs

Nominal current:	adjustable 1...5 A
Maximum:	7.5 A (sinusoidal)
Consumption:	$\leq I^2 \times 0.01 \Omega$ per phase
Overload capability:	10 A continuous 100 A, 10 x 1 s, interval 100 s

Current measurement via Rogowski coils

Measurement range: 0...3000A, auto-ranging
See operating instructions of Rogowski coil ACF3000_4/24 for further information

Nominal voltage:	57.7...400 V _{LN} , 100...693 V _{LL}
Maximum:	480 V _{LN} , 832 V _{LL} (sinusoidal)
Consumption:	$\leq U^2 / 3 M\Omega$ per phase
Impedance:	3 M Ω per phase
Overload capability:	480 V _{LN} , 832 V _{LL} continuous 600 V _{LN} , 1040 V _{LL} , 10 x 10 s, interval 10 s 800 V _{LN} , 1386 V _{LL} , 10 x 1 s, interval 10 s

Systems:	Single phase Split phase (2 phase system) 3-wire, balanced load 3-wire, unbalanced load 3-wire, unbalanced load, Aron connection 4-wire, balanced load, 4-wire, unbalanced load 4-wire, unbalanced load, Open-Y
-----------------	---

Nominal frequency:	45... 50 / 60 ...65 Hz
Measurement TRMS:	up to 63rd harmonic

I/O-Interface

Basic device:	1 relay output, changeover contact 1 digital output (fixed) 1 digital input (fixed)
----------------------	---

I/O extension 1:	2 relay outputs, changeover contact 4 bipolar analog outputs 2 digital inputs/outputs
-------------------------	---

I/O extension 2:	2 relay outputs, changeover contact 6 digital inputs/outputs
-------------------------	---

Analog outputs:	via plug-in terminals, galvanically isolated
Linearization:	Linear, quadratic, kinked
Range:	± 20 mA (24 mA max.), bipolar
Uncertainty:	$\pm 0.2\%$ of 20 mA
Burden:	$\leq 500 \Omega$ (max. 10 V / 20 mA)
Burden influence:	$\leq 0.2\%$
Residual ripple:	$\leq 0.4\%$

Interfaces

Modbus/RTU	via plug-in terminals
Physics:	RS-485, max. 1200 m (4000 ft)
Baud rate:	1,2 bis 115,2 kBaud
Number of participants:	≤ 32
Profibus DP	via 9-pin D-Sub socket
Physics:	RS-485, max. 100...1200 m
Baud rate:	automat. detection (9,6 kBit/s...12 MBit/s)
Number of participants:	≤ 32

Time reference: Internal clock (RTC)

Uncertainty:	± 2 minutes / month (15 up to 30°C), trimmable via PC software
--------------	---

Measurement uncertainty

	Version with Rogowski current inputs The additional uncertainty of the Rogowski coils ACF 3000_4/24 is not included in the following specifications: See operating instructions of Rogowski coil ACF3000_4/24.
---	--

Reference conditions: Ambient 15...30°C, sinusoidal, (acc. IEC/EN 60688) measurement over 8 cycles, PF=1, frequency 50...60 Hz

Voltage, current:	$\pm (0.08\% MV + 0.02\% MR)$ ^{1) 2)}
Power:	$\pm (0.16\% MV + 0.04\% MR)$ ^{3) 2)}
Power factor:	$\pm 0.1^\circ$ ⁴⁾
Frequency:	± 0.01 Hz
Imbalance U _I , I:	$\pm 0.5\%$
Harmonics:	$\pm 0.5\%$
THD voltage:	$\pm 0.5\%$
TDD current:	$\pm 0.5\%$
Active energy:	Class 0.5S, EN 62053-22
Reactive energy:	Class 2, EN 62053-23

Power supply:	via plug-in terminals
Nominal voltage:	100...230 V AC $\pm 15\%$, 50...400 Hz 24...230 V DC $\pm 15\%$
Consumption:	≤ 7 VA

Relays:	via plug-in terminals
Contacts:	changeover contact, bistabil
Load capacity:	250 V AC, 2 A, 500 VA 30 V DC, 2 A, 60 W

Digital inputs / outputs

Connection via plug-in terminals. For I/O extension individually configurable as input or output.

Inputs (acc. EN 61 131-2 DC 24 V Type 3):

Nominal voltage	12 / 24 V DC (30 V max.)
Logical ZERO	- 3 up to + 5 V
Logical ONE	8 up to 30 V

Outputs (partly acc. EN 61 131-2):

Nominal voltage	12 / 24 V DC (30 V max.)
Nominal current	50 mA (60 mA max.)
Load capability	400 Ω ... 1 M Ω

Ethernet	via RJ45-connector
Physics:	Ethernet 100BaseTX
Mode:	10/100 MBit/s, full / half duplex, Auto negotiation
Protocols:	Modbus/TCP NTP (time synchronization)

Synchronization:	via synchronization pulse or NTP server
Running reserve:	> 10 years

¹⁾ MV: measured value, MR: measurement range (maximum)

²⁾ Additional uncertainty for voltage measurement of 0.1% MV if neutral wire not connected (3-wire connections)

³⁾ MR: maximum voltage x maximum current

⁴⁾ Additional uncertainty of 0.1° if neutral wire not connected (3-wire connections)

Disposable measured quantities

Basic measured quantities

These measured quantities are determined using the configured measurement time (2...1024 cycles, in steps of 2 cycles). The display refreshment takes place with the refresh rate set.

Measured quantity	present	max	min
Voltage per phase, system	•	•	•
Mean value of voltages U_{mean}	•		
Zero displacement voltage U_{NE}	•	•	
Maximum $\Delta U <> U_{\text{mean}}^{1)}$	•	•	•
Phase angle of voltages	•		
Current per phase, system	•	•	
Mean value of phase currents	•		
Neutral current I_{N}	•	•	
Maximum $\Delta I <> I_{\text{mean}}^{2)}$	•	•	

Measured quantity	present	max	min
Bimetal current per phase, system	•	•	
Active power per phase, system	•	•	
Reactive power per phase, system	•	•	
Apparent power per phase, system	•	•	
Frequency	•	•	•
Power factor per phase, system	•	•	
Power factor per quadrant			•
Reactive power factor per phase, system	•		
LF factor per phase, system	•		

Power quality analysis

These values are calculated about twice a second, depending on the system frequency.

Measured quantity	present	max	min
Harmonic analysis			
THD voltage per phase	•	•	
TDD current per phase	•	•	
Harmonics voltage 2nd – 50th per phase	•	•	
Harmonics current 2nd – 50th per phase	•	•	
Distortion reactive power per phase, system	•	•	
Fundamental reactive power per phase, system	•	•	
cosφ fundamental per phase, system	•		•

Measured quantity	present	max	min
Imbalance currents / voltages			
Symmetrical components [V]	•		
Symmetrical components [A]	•		
Imbalance voltage: negative/positive sequence	•	•	
Imbalance voltage: zero/positive sequence ⁴⁾	•	•	
Imbalance current: negative/positive sequence	•		
Imbalance current: zero/positive sequence ⁴⁾	•	•	

Meters

Measured quantity	present	HT	LT
Active energy incoming: per phase, system	•	•	•
Active energy outgoing system	•	•	•
Reactive energy incoming: per phase, system	•	•	•

Measured quantity	present	HT	LT
Reactive energy outgoing system	•	•	•
Reactive energy inductive, capacitive system	•	•	•
I/O meters 1...7 ³⁾	•	•	•

Mean-values

As a standard the mean-values of the system power quantities are determined over the same programmable interval time t1. The interval time t2 of the selectable mean-value quantities may be different but equal for all 12 quantities.

Measured quantity	present	trend	max	min	history
Active power incoming 1 s...60 min	•	•	•	•	5
Active power outgoing 1 s...60 min	•	•	•	•	5
Reactive power incoming 1 s...60 min	•	•	•	•	5
Reactive power outgoing 1 s...60 min	•	•	•	•	5

Measured quantity	present	trend	max	min	history
Reactive power induct. 1 s...60 min	•	•	•	•	5
Reactive power capac. 1 s...60 min	•	•	•	•	5
Apparent power 1 s...60 min	•	•	•	•	5
Mean-value quant. 1-12 1 s...60 min ⁴⁾	•	•	•	•	1

1) Maximum deviation from the mean-value of the 3 phase voltages

2) Maximum deviation from the mean-value of the 3 phase currents

3) Possible meters of the digital pulse inputs – any measurand and unit

4) Available via communication interface only, no indication on display

Ambient conditions, general information

Operating temperature: $-10 \dots 15 \dots 30 \dots +55^\circ\text{C}$
 Storage temperature: -25 up to $+70^\circ\text{C}$
 Temperature influence: $0.5 \times$ basic uncertainty per 10 K
 Long term drift: $0.2 \times$ basic uncertainty per year

Others: Usage group II (EN 60688)
 Relative humidity: $< 95\%$ no condensation
 Altitude: $\leq 2000\text{ m}$ max.
 Device to be used indoor only!

Mechanical attributes

Orientation: Any
 Housing material: Polycarbonat (Makrolon)
 Weight: 500 g
 Flammability class: V-0 acc. UL94, self-extinguishing, non-dripping, free of halogen

APLUS without display for top-hat rail mounting

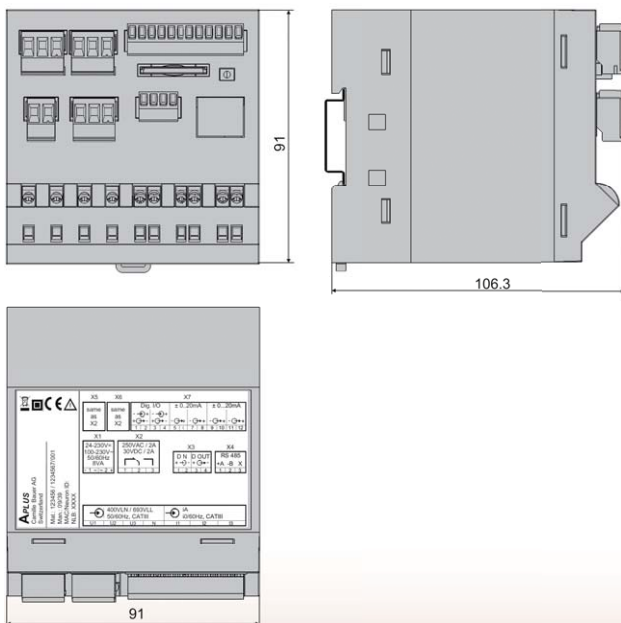

APLUS with display for panel mounting

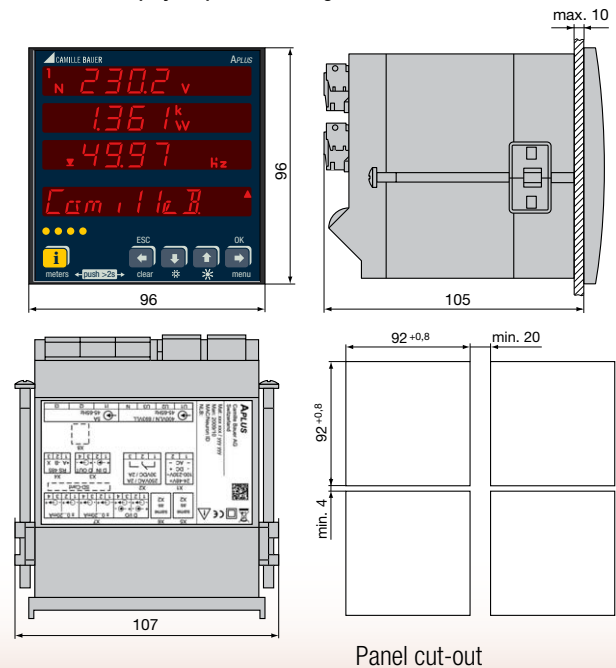

Safety

The current inputs are galvanically isolated from each other.
 Protection class: II (protective insulation, voltage inputs via protective impedance)
 Pollution degree: 2

Protection rating: IP64 (front), IP40 (housing), IP20 (terminals)
 Measurement category: CAT III, CATII (relays)

Applied standards, regulations and directives

IEC/EN 61 010-1	Safety regulations for electric measuring, control and laboratory equipment	IEC/EN 61 000-6-2/61 000-6-4:	Electromagnetical compatibility (EMC) Generic standards for industrial environment
IEC/EN 60 688	Electrical measuring transducers for converting AC electrical variables into analog or digital signals	IEC/EN 61 131-2	Programmable controllers – equipment, requirements and tests (digital inputs/outputs 12/24V DC)
DIN 40 110	AC quantities	IEC/EN 61 326	Electrical equipment for measurement, control and laboratory use – EMC requirements
IEC/EN 60 068-2-1/-2/-3/-6/-27:	Ambient tests -1 Cold, -2 Dry heat, -3 Damp heat, -6 Vibration, -27 Shock	IEC/EN 62 053-31	Pulse output devices for electromechanical and electronic meters (SO output)
IEC/EN 60 529	Protection type by case	UL94	Test for flammability of plastic materials for parts in devices and appliances
2002/95/EG (RoHS)	EC directive on the restriction of the use of certain hazardous substances		

Mobile energy demand acquisition

Before an energy management system is installed, usually in advance an analysis of the present state is made to identify possible saving potentials. Thereby you can detect how much energy is consumed, where it is consumed and if cost-relevant peak loads or reactive energy demands occur.

The **CAM mobile** is designed for the mobile analysis in low-voltage power systems. It provides the following functions to the user:

- Analysis of the present system state for monitoring and maintenance purpose
- Detection of disturbances, such as voltage variations or dips
- Load analysis of power distribution systems, generators and transformers
- Identification of billing relevant quantities, such as load curves and peak loads
- Acquisition of the total consumption of active and reactive energy in all 4 quadrants

By using Rogowski coils for current measurement a wide range of applications in distributions from 30 up to 3000 A can be covered, without any hardware variance. And this without interference into the existing installation. The ideal device for energy distributors or electricians.

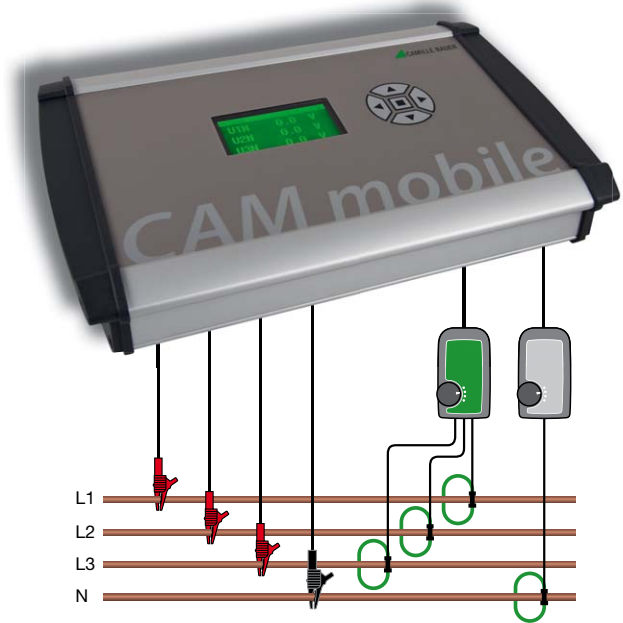

 **CAMILLE BAUER**

Rely on us.

Camille Bauer AG
Aargauerstrasse 7
CH-5610 Wohlen / Switzerland
Telephone: +41 56 618 21 11
Telefax: +41 56 618 21 21
info@camillebauer.com
www.camillebauer.com