

Relays Sockets

RU/RR/RH/RM/RV & Latch Relays

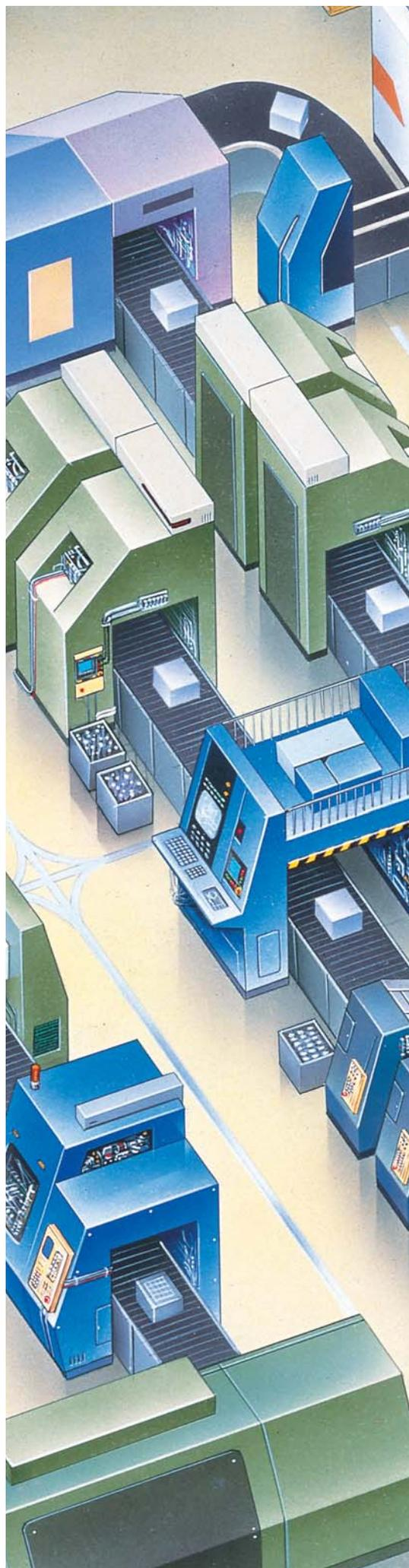

**General-purpose electromechanical relays
Relay sockets for mounting in three ways**

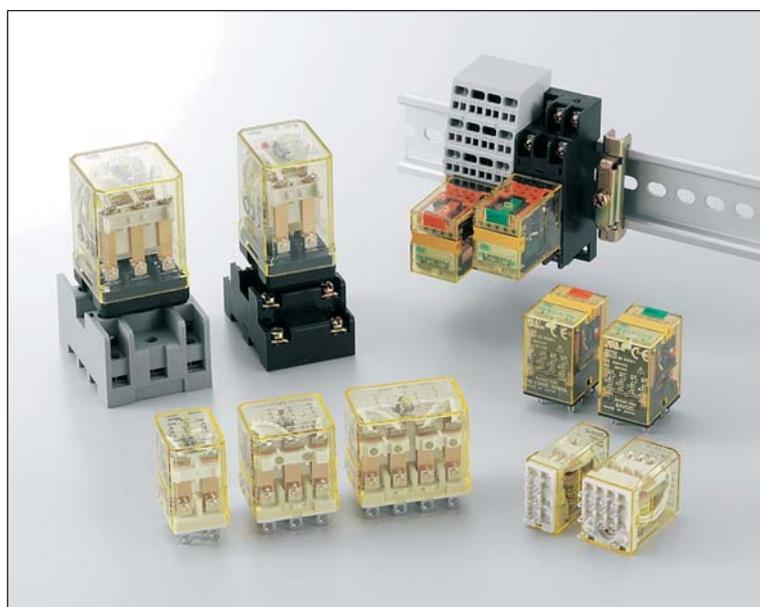

Relay Selection Guide

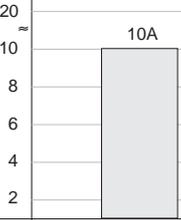
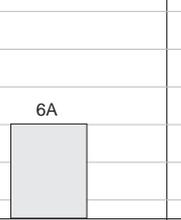
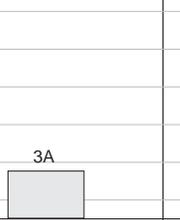
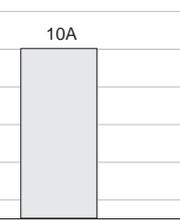
Category		Universal Relay			Power Relay
Type		RU			RR
General		<ul style="list-style-type: none"> • DPDT, 10A contact • Miniature size 	<ul style="list-style-type: none"> • 4PDT, 6A contact • Miniature size 	<ul style="list-style-type: none"> • 4PDT, 3A contact • Bifurcated contact type 	<ul style="list-style-type: none"> • SPDT, 10A contact • Heavy duty power relay
Appearance					
Type No.	Pin Terminal	—	—	—	—
	Blade Terminal	RU2S	RU4S	RU42S	RR1BA-U
	PC Board Terminal	RU2V	RU4V	RU42V	—
Contact	Contact Configuration	DPDT	4PDT	4PDT	SPDT
	Contact Material	Silver alloy	Gold-clad silver	Gold-clad silver-nickel	Silver
	Maximum Capacity (A)				
	Rated Load (resistive load)	250V AC, 10A 30V DC, 10A	250V AC, 3A 30V DC, 3A	250V AC, 3A 30V DC, 3A	110V AC, 10A 220V AC, 7.5A 30V DC, 10A
Coil	Rated Voltage	24, 100 (100-110), 110 (110-120), 200 (200-220), 220 (220-240)V AC 6, 12, 24, 48, 110V DC		24, 100 (100-110), 110 (110-120), 200 (200-220), 220 (220-240)V AC 6, 12, 24, 48, 100, 110V DC	6, 12, 24, 50, 100, 110, 115, 120, 200, 220, 230, 240V AC 6, 12, 24, 48, 110V DC
	Power Consumption (approx.)	1.2 VA (60Hz) 1W			2.5 VA (60Hz) 1.5W
	Pickup Voltage (against rated values)	AC: 80% max., DC: 80% max.			AC: 80% max., DC: 80% max.
	Dropout Voltage (against rated values)	AC: 30% min., DC: 10% min.			AC: 30% min., DC: 15% min.
Contact Resistance	*1	50 mΩ max.			30 mΩ max.
Operate Time	*2	20 ms max.			25 ms max.
Release Time	*2	20 ms max.			25 ms max.
Insulation Resistance		100 MΩ min. (500V DC megger)			100 MΩ min. (500V DC megger)
Life	Mechanical	AC type: 50,000,000 operations min. DC type: 100,000,000 operations min.		50,000,000 operations min.	10,000,000 operations min.
	Electrical	100,000 operations min.	200,000 operations min.	100,000 operations min.	200,000 operations min.
Dielectric Strength	Between contact and coil	2500V AC, 1 minute			2000V AC, 1 minute
	Between same-pole contacts	1000V AC, 1 minute			1000V AC, 1 minute
Operating Temperature		Simple type: -55 to +70°C, Others: -55 to +60°C (no freezing)			-25 to +40°C (no freezing)
Operating Humidity		5 to 85% RH (no condensation)			5 to 85% RH (no condensation)
Applicable Sockets	DIN rail mount	SU2S-11L, SM2S-05A, SM2S-05C, SM2S-05D	SU4S-11L, SY4S-05A, SY4S-05C, SY4S-05D		SR3B-05
	Panel mount	SM2S-51	SY4S-51		SR3B-51
	PC board mount	SM2S-61	SY4S-61		—
Dimensions (H × W × D mm)		35 × 21 × 27.5			47.5 × 36 × 36
Weight (approx.)		35g			82g
Approvals		UL, c-UL, TÜV, CE			UL, CSA
See Page		8			15

Note: The above table shows initial values.

*1: Measured using 5V DC, 1A voltage drop method

*2: Measured at the rated voltage (25°C)

Relay Selection Guide

Power Relay		Power Relay			
RR		RH			
<ul style="list-style-type: none"> • DPDT, 3PDT; 10A contact • Heavy duty power relay 		<ul style="list-style-type: none"> • SPDT, DPDT, 3PDT, 4PDT; 10A contact • Miniature size 			
					
RR2P-U	RR3P-U RR3PA-U	—	—	—	—
RR2BA-U	RR3B-U	RH1B-U	RH2B-U	RH3B-U	RH4B-U
—	—	RH1V2-U	RH2V2-U	RH3V2-U	RH4V2-U
DPDT	3PDT	SPDT	DPDT	3PDT	4PDT
Silver		Silver cadmium oxide			
					
110V AC, 10A 220V AC, 7.5A 30V DC, 10A		110V AC/ 30V DC, 10A 220V AC, 7A		110V AC/30V DC, 10A 220V AC, 7.5A	
6, 12, 24, 50, 100, 110, 115, 120, 200, 220, 230, 240V AC 6, 12, 24, 48, 110V DC		6, 12, 24, 50, 100, 110, 115, 120, 200, 220, 230, 240V AC 6, 12, 24, 48, 100, 110V DC	6, 12, 24, 50, 100-110, 110-120, 200-220, 220-240V AC 6, 12, 24, 48, 100-110V DC	6, 12, 24, 50, 100, 110, 115, 120, 200, 220, 230, 240V AC 6, 12, 24, 48, 100, 110V DC	
2.5 VA (60Hz) 1.5W		1 VA (60Hz) 0.8W	1.2 VA (60Hz) 0.9W	1.7 VA (60Hz) 1.5W	2 VA (60Hz) 1.5W
AC: 80% max., DC: 80% max.		AC: 80% max., DC: 80% max.			
AC: 30% min., DC: 15% min.		AC: 30% min., DC: 10% min.			
30 mΩ max.		50 mΩ max.			
25 ms max.		20 ms max.		25 ms max.	
25 ms max.		20 ms max.		25 ms max.	
100 MΩ min. (500V DC megger)		100 MΩ min. (500V DC megger)			
10,000,000 operations min.		50,000,000 operations min.			
200,000 operations min.		200,000 operations min.	500,000 operations min.	200,000 operations min.	
Pin terminal: 1500V AC, 1 minute Blade terminal: 2000V AC, 1 minute		2000V AC, 1 minute			
1000V AC, 1 minute		1000V AC, 1 minute			
-25 to +40°C (no freezing)		-25 to +50°C (no freezing)	-25 to +40°C (no freezing)		
5 to 85% RH (no condensation)		5 to 85% RH (no condensation)			
SR2P-05A, SR2P-06A, SR2P-05C, SR3B-05	SR3P-05A, SR3P-06A, SR3P-05C	SH1B-05A, SH1B-05C	SH2B-05A, SH2B-05C, SH2B-05D	SH3B-05A, SH3B-05C	SH4B-05A, SH4B-05C
SR2P-511, SR2P-70, SR3B-51	SR3P-511, SR3P-70, SR3B-51	SH1B-51	SH2B-51	SH3B-51	SH4B-51
—	—	SH1B-62	SH2B-62	SH3B-62	SH4B-62
55.5 × 29 × 36	55.5 × 36 × 36	35.6 × 14 × 27.5	35.6 × 21 × 27.5	35.6 × 31 × 27.5	35.6 × 41 × 27.5
90g (pin terminal)	96g (pin terminal)	24g	37g	50g	74g
UL, CSA, TÜV, CE		UL, CSA, TÜV, CE			
15		19			

Relay Selection Guide

Category		Miniature Relay	Miniature Relay			
Type		RM	RY			
General		<ul style="list-style-type: none"> • DPDT, 5A contact • Miniature lightweight relay 	<ul style="list-style-type: none"> • DPDT, 4PDT; 3A or 5A contact • 1A bifurcated contact also available 			
Appearance						
Type No.	Pin Terminal	—	—	—	—	
	Blade Terminal	RM2S-U	RY2S-U	RY4S-U	RY22S-U	
	PC Board Terminal	RM2V-U	RY2V-U	RY4V-U	RY22V-U	
Contact	Contact Configuration	DPDT	DPDT	4PDT	DPDT (bifurcated)	
	Contact Material	Silver	Gold-clad silver		Silver palladium	
	Maximum Capacity (A)	20				
		10				
		8				
6						
Rated Load (resistive load)	110V AC, 5A 220V AC, 5A 30V DC, 5A	110V AC/30V DC, 3A 220V AC, 3A	240V AC, 5A 30V DC, 5A	110V AC/30V DC, 1A 220V AC, 0.8A		
Coil	Rated Voltage	6, 12, 24, 50, 100-110, 200-220, 220-240V AC 6, 12, 24, 48, 100-110V DC	DPDT: 6, 12, 24, 50, 100, 110, 115, 120, 200, 220, 230, 240V AC 6, 12, 24, 48, 100, 110V DC 4PDT: 6, 12, 24, 50, 100-110, 110-120, 200-220, 220-240V AC 6, 12, 24, 48, 100-110V DC			
	Power Consumption (approx.)	1.2 VA (60Hz) 0.9W	1 VA (60Hz) 0.8W	1.2 VA (60Hz) 0.9W	1 VA (60Hz) 0.8W	
	Pickup Voltage (against rated values)	AC: 80% max., DC: 80% max.	AC: 80% max., DC: 80% max.			
	Dropout Voltage (against rated values)	AC: 30% min., DC: 10% min.	AC: 30% min., DC: 10% min.			
Contact Resistance	*1	30 mΩ max.	50 mΩ max.		100 mΩ max.	
Operate Time	*2	20 ms min.	20 ms min.			
Release Time	*2	20 ms min.	20 ms min.			
Insulation Resistance		100 MΩ min. (500V DC megger)	100 MΩ min. (500V DC megger)			
Life	Mechanical	50,000,000 operations min.	50,000,000 operations min.			
	Electrical	500,000 operations min.	200,000 operations min.	<ul style="list-style-type: none"> • 100,000 operations min. • 200,000 operations min. (220V AC, 3A) 	200,000 operations min.	
Dielectric Strength	Between contact and coil	2000V AC, 1 minute	1500V AC, 1 minute	2000V AC, 1 minute	1500V AC, 1 minute	
	Between same-pole contacts	1000V AC, 1 minute	1000V AC, 1 minute			
Operating Temperature		-25 to +50°C (no freezing)	-25 to +55°C (no freezing)			
Operating Humidity		45 to 85% RH (no condensation)	45 to 85% RH (no condensation)			
Applicable Sockets	DIN rail mount	SM2S-05A SM2S-05C SM2S-05D	SY2S-05A SY2S-05C	SY4S-05A SY4S-05C SY4S-05D	SY2S-05A SY2S-05C	
	Panel mount	SM2S-51	SY2S-51	SY4S-51	SY2S-51	
	PC board mount	SM2S-61 SM2S-62	SY2S-61	SY4S-61 SY4S-62	SY2S-61	
Dimensions (H x W x D mm)		35.6 x 21 x 27.5	35.6 x 14 x 27.5	35.6 x 21 x 27.5	35.6 x 14 x 27.5	
Weight (approx.)		35g	23g	34g	23g	
Approvals		UL, CSA, TÜV, CE	UL, CSA, TÜV, CE			
See Page		26	29			

Note: The above table shows initial values.

*1: Measured using 5V DC, 1A voltage drop method

*2: Measured at the rated voltage (25°C)

Relay Selection Guide

Latch Relay			
	RR2KP	RH2L	RY2KS
	<ul style="list-style-type: none"> • DPDT; 10A contact • Dual coil latch relay 	<ul style="list-style-type: none"> • DPDT; 10A contact • Midget power latch relay • With a mechanical operation indicator 	<ul style="list-style-type: none"> • DPDT; 3A contact • Dual coil latch relay
			
	RR2KP-U	—	—
	—	RH2LB-U	RY2KS-U
	—	RH2LV2-U	—
	DPDT	DPDT	DPDT
	Silver	Silver cadmium oxide	Gold-plated silver
	10A	10A	3A
			
	110V AC/10A, 220V AC/7.5A 30V DC/10A, 100V DC/0.5A	110V AC/10A, 220V AC/7.5A 30V DC/10A	110/220V AC, 3A 30V DC, 3A 100V DC, 0.2A
	6, 12, 24, 50, 100, 110, 115, 120, 200, 220, 230, 240V AC 6, 12, 24, 48, 110V DC	6, 12, 24, 50, 100, 120V AC 6, 12, 24V DC	6, 12, 24, 50, 100, 120V AC 6, 12, 24, 48, 100, 110V DC
	2.2 VA (60Hz) 1.5W	Set coil: 1.2 VA (60Hz), 2W Reset coil: 0.5 VA (60Hz), 0.9W	1.5 VA (60Hz) 1.2W
	Set voltage: 80% max.	Set voltage: 80% max.	Set voltage: 80% max.
	Reset voltage: 80% max.	Reset voltage: 80% max.	Reset voltage: 80% max.
	30 mΩ max.	50 mΩ max.	50 mΩ max.
	Set time: 20 ms max.	Set time: 30 ms max. (AC) 20 ms max. (DC)	Set time: 25 ms max.
	Reset time: 20 ms max.	Reset time: 30 ms max. (AC) 20 ms max. (DC)	Reset time: 25 ms max.
	100 MΩ min. (500V DC megger)	100 MΩ min. (500V DC megger)	100 MΩ min. (500V DC megger)
	5,000,000 operations min.	10,000,000 operations min.	5,000,000 operations min.
	500,000 operations min.	200,000 operations min.	200,000 operations min.
	1500V AC, 1 minute	2000V AC, 1 minute	1500V AC, 1 minute
	1000V AC, 1 minute	1000V AC, 1 minute	700V AC, 1 minute
	-5 to +40°C (no freezing)	-5 to +40°C (no freezing)	-5 to +40°C (no freezing)
	45 to 85% RH (no condensation)	45 to 85% RH (no condensation)	45 to 85% RH (no condensation)
	SR3P-05A SR3P-05C SR3P-06A	SH3B-05A SH3B-05C	SY4S-05A SY4S-05C
	SR3P-511 SR3P-70	SH3B-51	SY4S-51
	—	SH3B-62	SY4S-61 SY4S-62
	80.5 × 36 × 36	35.6 × 31 × 27.5	55.3 × 21 × 27.5
	170g	50g	67g
	UL, CSA	UL, CSA	UL, CSA
	34	36	38

Operating Instructions

Operating Instructions

Driving Circuit for Relays

- To make sure of correct relay operation, apply the rated voltage to the relay coil.
- Input voltage for the DC coil:

A complete DC voltage is best for the coil power to make sure of stable relay operation. When using a power supply containing a ripple voltage, suppress the ripple factor within 5%. When power is supplied through a rectification circuit, the relay operating characteristics, such as pickup voltage and dropout voltage, depend on the ripple factor. Connect a smoothing capacitor for better operating characteristics as shown below.

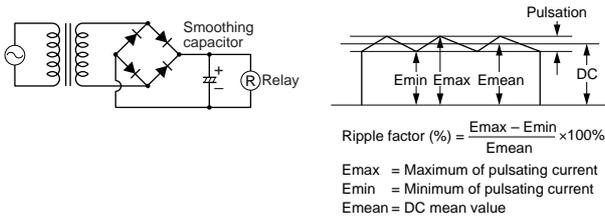

- Operating the relay in synchronism with AC load:

If the relay operates in synchronism with the AC power voltage of the load, the relay life may be reduced. If this is the case, select a relay in consideration of the required reliability for the load. Or, make the relay to turn on and off irrespective of the AC power phase or near the point where the AC phase crosses zero voltage.

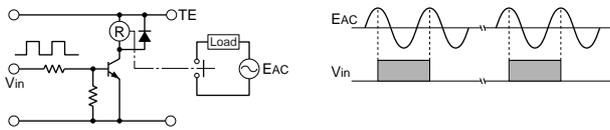

- Leakage current while relay is off:

When driving an element at the same time as the relay operation, a special consideration is needed for the circuit design. As shown in the incorrect circuit below, a leakage current (*I_o*) flows through the relay coil while the relay is off. The leakage current causes the coil release failure or adversely affects the vibration resistance and shock resistance. Design the circuit as shown in the correct example.

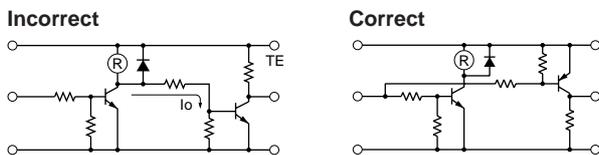

- Surge suppression for transistor driving circuits:

When the relay coil is turned off, a high-voltage pulse is generated, causing the transistor to deteriorate and sometimes to break. Be sure to connect a diode to suppress the counter electromotive force. Then, the coil release time becomes slightly longer. To shorten the coil release time, connect a Zener diode between the collector and emitter of the transistor. Select a Zener diode with a Zener voltage slightly higher than the power voltage.

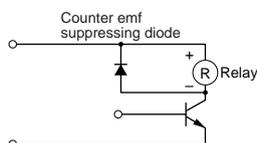

Protection for Relay Contacts

- The contact ratings show the maximum values. Make sure that these values are not exceeded at any instant. When an inrush current flows through the load, the contact may be welded. If this is the case, connect a contact protection circuit, such as a current limiting resistor.

- Contact protection circuit:

When switching an inductive load, arcing causes carbides to form on the contacts, resulting in an increased contact resistance. In consideration of contact reliability, contact life, and noise suppression, use of a surge absorbing circuit is recommended. Then, note that the release time of the load becomes slightly longer. Check the operation using the actual load. Incorrect use of a contact protection circuit will adversely affect the switching characteristics. Four typical examples of contact protection circuits are shown in the following table:

RC		This protection circuit can be used when the load impedance is smaller than the RC impedance in an AC load power circuit. R: Resistor of approximately the same resistance value as the load C: 0.1 to 1 μF
		This protection circuit can be used for both AC and DC load power circuits. R: Resistor of approximately the same resistance value as the load C: 0.1 to 1 μF
Diode		This protection circuit can be used for DC load power circuits. Use a diode with the following ratings. Reverse withstand voltage: Power voltage of the load circuit × 10 Forward current: More than the load current
Varistor		This protection circuit can be used for both AC and DC load power circuits. For a best result, when using on a power voltage of 24 to 48V AC/DC, connect a varistor across the load. When using on a power voltage of 100 to 240V AC/DC, connect a varistor across the contacts.

- Do not use a contact protection circuit as shown below:

	This protection circuit is very effective in arc suppression when opening the contacts. But, the capacitor is charged while the contacts are opened. When the contacts are closed, the capacitor is discharged through the contacts, increasing the possibility of contact welding.
	This protection circuit is very effective in arc suppression when opening the contacts. But, when the contacts are closed, a current flows to charge the capacitor, causing contact welding.

Generally, switching a DC inductive load is more difficult than switching a DC resistive load. Using an appropriate arc suppressor, however, will improve the switching characteristics of a DC inductive load.

Soldering

- When soldering the relay terminals, use a soldering iron of 30 to 60W, and quickly complete soldering within approximately 3 seconds.
- Use a non-corrosive rosin flux.

Operating Instructions

Other Precautions

1. General notice:

- To maintain the initial characteristics, do not drop the relay or apply shocks to the relay.
- The relay housing cannot be removed from the base during normal operation. To maintain the initial characteristics, do not remove the relay housing.
- Use the relay in environments free from condensation of dust, sulfur dioxide (SO₂), and hydrogen sulfide (H₂S).
- Make sure that the coil voltage does not exceed the applicable coil voltage range.

2. When connecting outputs to electronic circuits:

When the output is connected to a load which responds very quickly, such as an electronic circuit, contact bouncing causes incorrect operation of the load. Take the following measures into consideration.

- Connect an integral circuit.
 - Suppress the pulse voltage due to bouncing within the noise margin of the load.
- ### 3. UL- and CSA-approved ratings may differ from the product rated values determined by IEC depending on approval agents and local situations.
- ### 4. Do not use the relays in the vicinity of strong magnetic field sources, which may affect relay operation.



Safety Precautions

- Turn off the power to the relay before starting installation, removal, wiring, maintenance, and inspection of the relays. Failure to turn power off may cause electrical shock or fire hazard.
- Observe the specifications and rated values, otherwise electrical shock or fire hazard may be caused.
- Use wires of the proper size to meet the voltage and current requirements. Tighten the terminal screws on the relay socket to a proper tightening torque.
- The surge absorbing element on AC relays with RC or DC relays with diode is provided to absorb the counter electromotive force generated by the coil. When the relay is subject to an excessive external surge voltage, the surge absorbing element may be damaged. Add another surge absorbing provision to the relay to prevent damage.

Precautions for the RU Relays

- Before operating the latching lever of the RU relay, turn off the power to the RU relay. After checking the circuit, return the latching lever to the original position.
- Do not use the latching lever as a switch. The durability of the latching lever is a minimum of 100 operations.
- When using DC loads on 4PDT relays, apply a positive voltage to terminals of neighboring poles and a negative voltage to the other terminals of neighboring poles to prevent the possibility of short circuits.
- DC type relays with a diode have a polarity in the coil terminals. Apply the DC voltage to the correct terminals.

RU Series Universal Relays

Full featured universal miniature relays Designed with environment taken into consideration

- Two terminal styles: plug-in and PCB mount
- Non-polarized LED indicator available on plug-in relays
- No internal wires, lead-free construction
- Cadmium-free contacts
- Mechanical flag indicator available on plug-in relays
- Manual latching lever with color coding for AC or DC coil
- Snap-on yellow marking plate; optional marking plates are available in four other colors
- Maximum contact ratings: 10A (RU2), 6A (RU4), 3A (RU42)
- UL, CSA, c-UL, EN compliant

Standard	Mark	Approval Organization / File No.
UL508 CSA C22.2 No. 14		UL/c-UL File No. E66043
CSA C22.2 No. 14		CSA File No. LR35144 (CSA mark is printed on bifurcated contact types only)
EN61810-1		TÜV Product Service
		Self declaration (EC Low Voltage Directive)



With Latching Lever

Mechanical Indicator

The contact position can be confirmed through the five small windows.

Marking Plate

Standard yellow marking plate is easily replaced with optional marking plates in four colors for easy identification of relays.

LED Indicator

Non-polarized green LED indicator is standard provision for plug-in terminal, latching lever types

Lever in the Latched Position

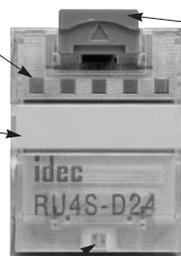

Latching Lever

Using the latching lever, operation can be checked without energizing the coil. The latching lever is color coded for AC and DC coils.

AC coil: Orange
DC coil: Green

In Normal Operation



Note: Turn off the power to the relay coil when using the latching lever. After checking the operation, return the latching lever in the normal position.

Without Latching Lever

AC/DC Color Marking

For identification of AC or DC coils.

AC coil: Yellow
DC coil: Blue

Mechanical Indicator

Marking Plate

LED Indicator

Non-polarized green LED indicator is standard provision for plug-in terminal types, except for simple types.

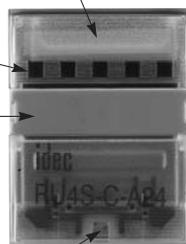

AC Coil



DC Coil

RU Series Universal Relays

Types

• Single Contact Type

Termination	Latching Lever	Type	Type No.		Coil Voltage Code *
			DPDT	4PDT	
Plug-in Terminal (Note 1)	With Latching Lever	Standard	RU2S-*	RU4S-*	A24, A100, A110, A200, A220 D6, D12, D24, D48, D110
		With RC (AC coil only)	RU2S-R-*	RU4S-R-*	A100, A110, A200, A220
		With diode (DC coil only)	RU2S-D-*	RU4S-D-*	D6, D12, D24, D48, D110
		With diode (DC coil only) Reverse polarity coil	RU2S-D1-*	RU4S-D1-*	D24
	Without Latching Lever	Standard	RU2S-C-*	RU4S-C-*	A24, A100, A110, A200, A220 D6, D12, D24, D48, D110
		With RC (AC coil only)	RU2S-CR-*	RU4S-CR-*	A100, A110, A200, A220
		With diode (DC coil only)	RU2S-CD-*	RU4S-CD-*	D6, D12, D24, D48, D110
		With diode (DC coil only) Reverse polarity coil	RU2S-CD1-*	RU4S-CD1-*	D24
		Simple (Note 2)	RU2S-NF-*	RU4S-NF-*	A24, A100, A110, A200, A220
	PCB Terminal	Without Latching Lever	Simple (Note 2)	RU2V-NF-*	RU4V-NF-*

• Bifurcated Contact Type

Termination	Latching Lever	Type	Type No. 4PDT	Coil Voltage Code *
Plug-in Terminal (Note 1)	With Latching Lever	Standard	RU42S-*	A24, A100, A110, A200, A220 D6, D12, D24, D48, D100, D110
		With RC (AC coil only)	RU42S-R-*	A100, A110, A200, A220
		With diode (DC coil only)	RU42S-D-*	D6, D12, D24, D48, D100, D110
		With diode (DC coil only) Reverse polarity coil	RU42S-D1-*	D24
	Without Latching Lever	Standard	RU42S-C-*	A24, A100, A110, A200, A220 D6, D12, D24, D48, D100, D110
		With RC (AC coil only)	RU42S-CR-*	A100, A110, A200, A220
		With diode (DC coil only)	RU42S-CD-*	D6, D12, D24, D48, D100, D110
		With diode (DC coil only) Reverse polarity coil	RU42S-CD1-*	D24
		Simple (Note 2)	RU42S-NF-*	A24, A100, A110, A200, A220
	PCB Terminal	Without Latching Lever	Simple (Note 2)	RU42V-NF-*

Note 1: Plug-in terminal types, except for simple types, have an LED indicator and a mechanical indicator as standard.

Note 2: Simple types do not have an LED indicator, a mechanical indicator, and a latching lever.

Ordering Information

Specify a coil voltage code in place of * in the Type No.

Coil Voltage Code *	Coil Rating
A24	24V AC
A100	100-110V AC
A110	110-120V AC
A200	200-220V AC
A220	220-240V AC
D6	6V DC
D12	12V DC
D24	24V DC
D48	48V DC
D100	100V DC
D110	110V DC

Accessory

Name	Type No.	Ordering Type No.	Color Code *	Package Quantity
Marking Plate	RU9Z-P*	RU9Z-P*PN10	A (orange), G (green), S (blue), W (white), Y (yellow)	10

Note: Specify a color code in place of the Type No. When ordering, specify the Ordering Type No.

The marking plate can be removed from the relay by inserting a flat screwdriver under the marking plate.

RU series Universal Relays

Coil Ratings

Rated Voltage (V)	Coil Voltage Code	Rated Current (mA) ±15% (at 20°C)		Coil Resistance (Ω) ±10% (at 20°C)	Operating Characteristics (against rated values at 20°C)			
		50 Hz	60 Hz		Maximum Continuous Applied Voltage	Minimum Pickup Voltage	Dropout Voltage	
AC (50/60 Hz)	24	A24	49.3	42.5	110%	80% maximum	30% minimum	
	100-110	A100	9.2-11.0	7.8-9.0				164
	110-120	A110	8.4-10.0	7.1-8.2				3,460
	200-220	A200	4.6-5.5	4.0-4.6				4,550
	220-240	A220	4.2-5.0	3.6-4.2				14,080
DC	6	D6	155		40	110%	80% maximum	10% maximum
	12	D12	80		160			
	24	D24	44.7		605			
	48	D48	18		2,560			
	100	D100	9.7		10,000			
	110	D110	8.9		12,100			

Note 1: The rated current includes the current draw by the LED indicator.

Note 2: Rated voltage 100V DC is available for the bifurcated contact type only.

Contact Ratings

Contact	Continuous Current	Allowable Contact Power		Voltage (V)	Rated Load	
		Resistive Load	Inductive Load		Res. Load	Ind. Load
DPDT	10A	2500VA AC 300W DC	1250VA AC 150W DC	250 AC	10A	5A
				30 DC	10A	5A
4PDT	6A	1500VA AC 180W DC	600VA AC 90W DC	250 AC	3A	0.8A
				30 DC	3A	1.5A
4PDT bifurcated	3A	750VA AC 90W DC	200VA AC 45W DC	250 AC	3A	0.8A
				30 DC	3A	1.5A

Note 1: On 4PDT relays, the maximum allowable total current of neighboring two poles is 6A. At the rated load, make sure that the total current of neighboring two poles does not exceed 6A (3A + 3A = 6A).

Note 2: Inductive load for the rated load — $\cos \phi = 0.3$, L/R = 7 ms

• UL and c-UL Ratings

Voltage	Resistive			General Use			Horse Power Rating		
	RU2	RU4	RU42	RU2	RU4	RU42	RU2	RU4	RU42
250V AC	10A	—	3A	—	6A	—	—	1/10HP	—
30V DC	10A	6A	3A	—	—	—	—	—	—

• CSA Ratings

Voltage	Resistive	
	RU42	
250V AC	3A	
30V DC	3A	

• TÜV Ratings

Voltage	Resistive			Inductive		
	RU2	RU4	RU42	RU2	RU4	RU42
250V AC	10A	6A	3A	5A	0.8A	0.8A
30V DC	10A	6A	3A	5A	1.5A	1.5A

Surge Suppressor Ratings

Type	Ratings	
AC Coil	With RC	RC series circuit R: 20 kΩ, C: 0.033 μF
DC Coil	With Diode	Diode reverse voltage: 1000V Diode forward current: 1A

Specifications

Type (Contact)	RU2 (DPDT)	RU4 (4PDT)	RU42 (4PDT)
Contact Material	Silver alloy	Silver (gold clad)	Silver-nickel (gold clad)
Contact Resistance *1	50 mΩ maximum		
Minimum Applicable Load *2	24V DC, 5 mA (reference value)	1V DC, 1 mA	1V DC, 0.1 mA
Operate Time *3	20 ms maximum		
Release Time *3	20 ms maximum		
Power Consumption	AC: 1.1 to 1.4VA (50 Hz), 0.9 to 1.2VA (60 Hz) DC: 0.9 to 1.0W		
Insulation Resistance	100 MΩ minimum (500V DC megger)		
Dielectric Strength	Between contact and coil: 2500V AC, 1 minute		
	Between contacts of different poles: 2500V AC, 1 minute		
	2000V AC, 1 minute		
	Between contacts of the same pole: 1000V AC, 1 minute		
Operating Frequency	Electrical: 1800 operations/h maximum Mechanical: 18,000 operations/h maximum		
Vibration Resistance	Damage limits: 10 to 55 Hz, amplitude 0.5 mm Operating extremes: 10 to 55 Hz, amplitude 0.5 mm		
Shock Resistance	Damage limits: 1000 m/s ² Operating extremes: 150 m/s ²		
Mechanical Life	AC: 50,000,000 operations DC: 100,000,000 operations		50,000,000 operations
Electrical Life *4	See table below		
Operating Temperature *5	Simple types: -55 to +70°C (no freezing) Others: -55 to +60°C (no freezing)		
Operating Humidity	5 to 85% RH (no condensation)		
Weight	Approx. 35g		

Note: Above values are initial values.

*1: Measured using 5V DC, 1A voltage drop method

*2: Measured at operating frequency of 120 operations/min (failure rate level P, reference value)

*3: Measured at the rated voltage (at 20°C), excluding contact bouncing;
Release time of AC relays with RC: 25 ms maximum
Release time of DC relays with diode: 40 ms maximum

*4: Contact Load and Electrical Life (at ambient temperature 20°C)

Type	Voltage	Resistive Load	Inductive Load ($\cos \phi = 0.3$, L/R = 7 ms)	Electrical Life (operations minimum)
RU2	250V AC	10A	5A	100,000
		5A	2.5A	500,000
	30V DC	10A	5A	100,000
		5A	2.5A	500,000
RU4	250V AC	6	2.6A	50,000
		3A	0.8A	200,000
	30V DC	6A	2.7A	50,000
		3A	1.5A	200,000
	110V DC	0.65A	0.33A	50,000
		0.33A	0.18A	200,000
RU42	250V AC	3A	0.8A	100,000
	30V DC	3A	1.5A	100,000
	110V DC	0.44A	0.22A	100,000

*5: Measured at the rated voltage. Simple types include plug-in terminal simple types and all PCB terminal types.

RU Series Universal Relays

RU2 (DPDT Contact)

• Plug-in Terminal Type



- LED indicator, mechanical flag indicator, and marking plate are standard provisions, except on simple types.
- Available with or without a manual latching lever
- Simple types have a marking plate.



Photo: RU2S-A100

• PCB Terminal Type



- Marking plate is a standard provision.
- Not provided with an LED indicator, mechanical flag indicator, and manual latching lever.



Photo: RU2V-NF-A100

Dimensions

• RU2S

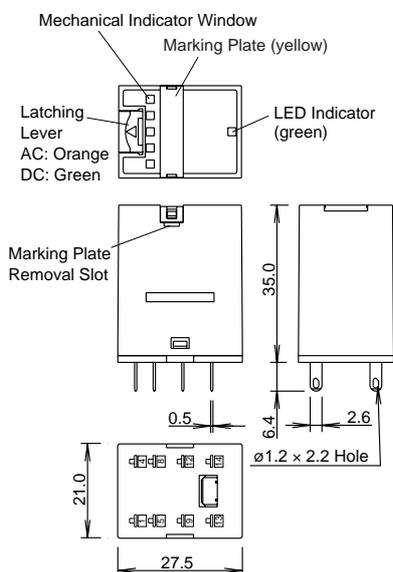

• RU2S-C/RU2S-NF

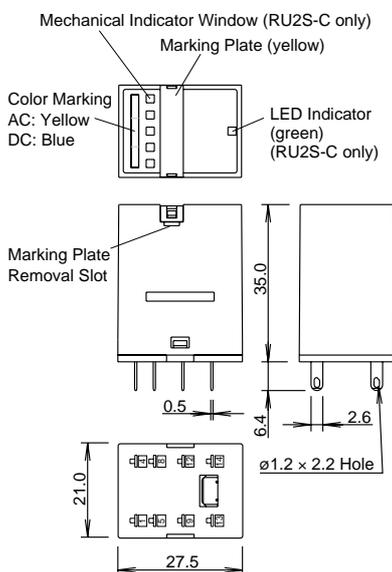

• RU2V

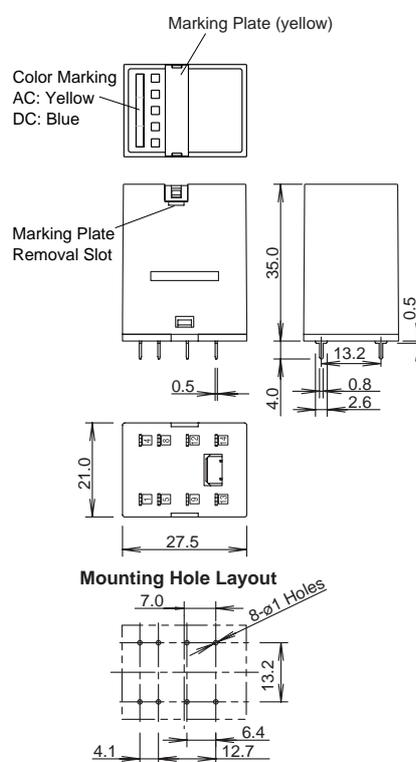

Marking plate removal slot is provided only on one side.
Insert a flat screwdriver into the slot to remove the marking plate.

All dimensions in mm.

Internal Connection (Bottom View)

• RU2S-* Standard

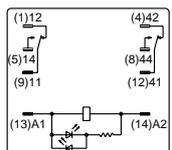

24V AC/DC or less

• RU2S-*R With RC

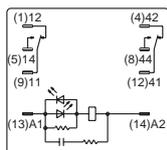

• RU2S-*D With Diode

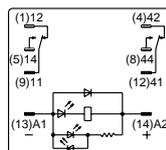

24V DC or less

• RU2S-*D1 With Diode Reverse Polarity Coil

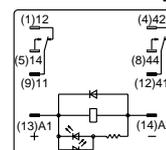

24V DC

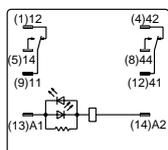

Over 24V AC/DC

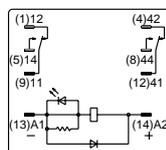

Over 24V DC

• RU2S-NF-*/RU2V-NF-*

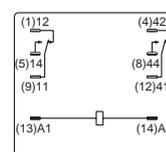

Blank or C comes in place of * to represent types with or without a latching lever.

RU series Universal Relays

Electrical Life Curves

• RU2 (Resistive Load)

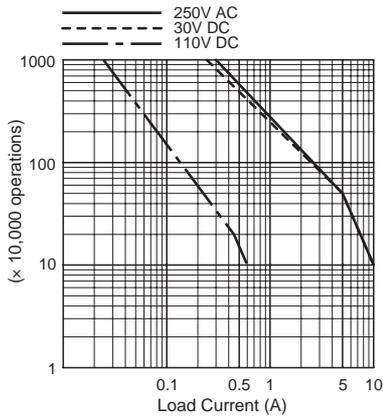

• RU2 (Inductive Load)

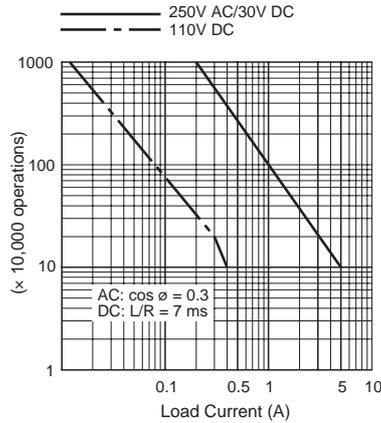

Maximum Switching Current

• RU2

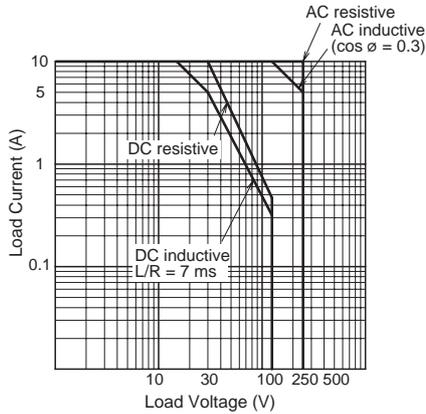

Ambient Temperature vs. Temperature Rise Curves

• RU2 (AC Coil, 50 Hz)

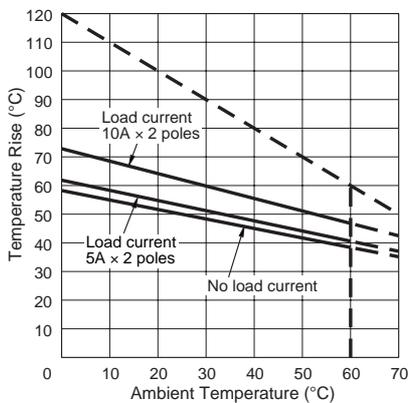

• RU2 (AC Coil, 60 Hz)

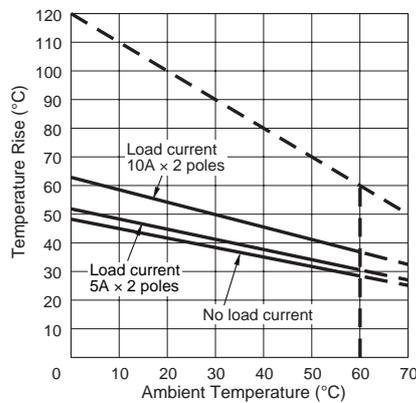

• RU2 (DC Coil)

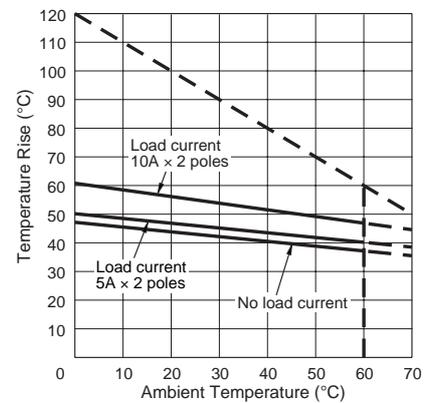

The above temperature rise curves show the characteristics when 100% the rated coil voltage is applied.

The heat resistance of the coil is 120°C. The slant dashed line indicates the allowable temperature rise for the coil at different ambient temperatures.

RU Series Universal Relays

RU4 (4PDT Contact)

• Plug-in Terminal Type



- LED indicator, mechanical flag indicator, and marking plate are standard provisions, except on simple types.
- Available with or without a manual latching lever
- Simple types have a marking plate.



Photo: RU42S-A100

• PCB Terminal Type



- Marking plate is a standard provision.
- Not provided with an LED indicator, mechanical flag indicator, and manual latching lever.



Photo: RU4V-NF-D24

Dimensions

• RU4S/RU42S

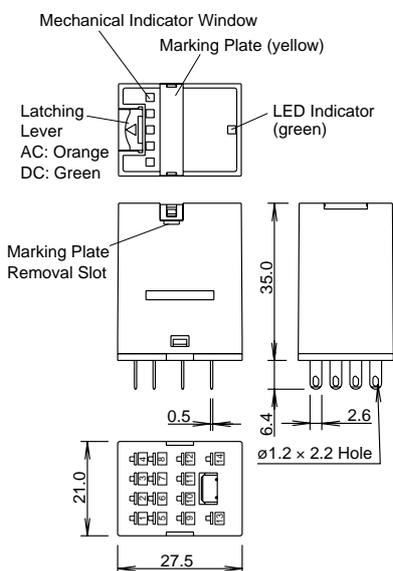

• RU4S-C/RU4S-NF RU42S-C/RU42S-NF

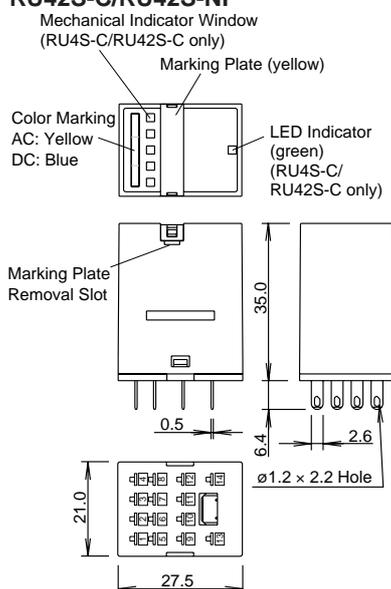

• RU4V/RU42V

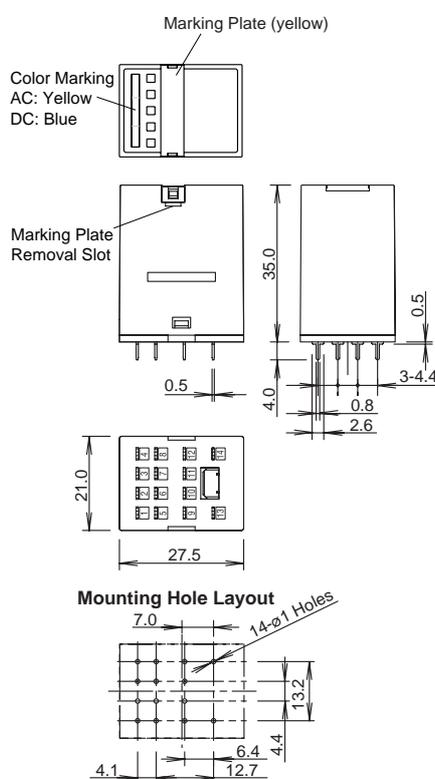

Marking plate removal slot is provided only on one side. Insert a flat screwdriver into the slot to remove the marking plate.

All dimensions in mm.

Internal Connection (Bottom View)

• RU4S-*/RU42S-* Standard

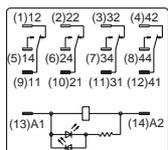

24V AC/DC or less

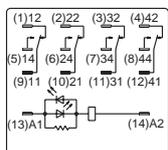

Over 24V AC/DC

• RU4S-*R/RU42S-*R With RC

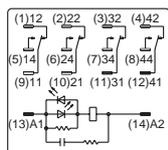

• RU4S-*D/RU42S-*D With Diode

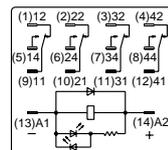

24V DC or less

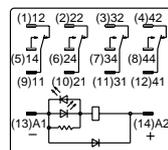

Over 24V DC

• RU4S-*D1/RU42S-*D1 With Diode Reverse Polarity Coil

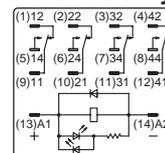

24V DC

• RU4S-NF-*/RU4V-NF-* RU42S-NF-*/RU42V-NF-*

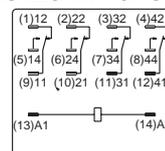

Blank or C comes in place of * to represent types with or without a latching lever.

RU series Universal Relays

Electrical Life Curves

• RU4 (Resistive Load)

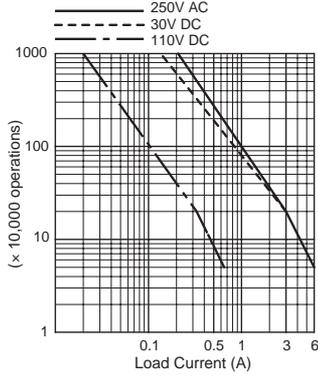

• RU4 (Inductive Load)

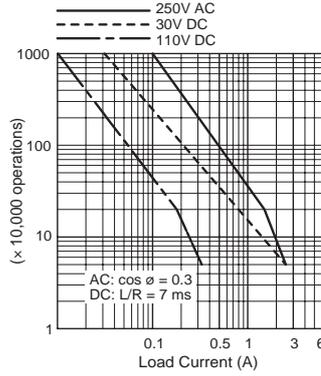

• RU42 (Resistive Load)

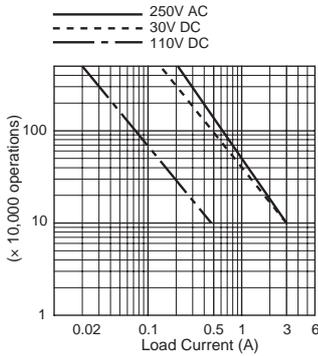

• RU42 (Inductive Load)

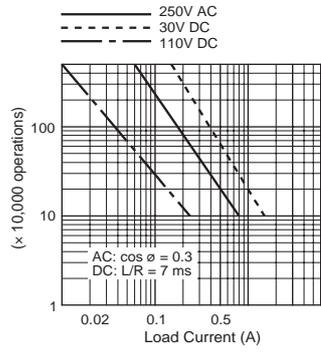

Maximum Switching Current

• RU4 (Rated Load)

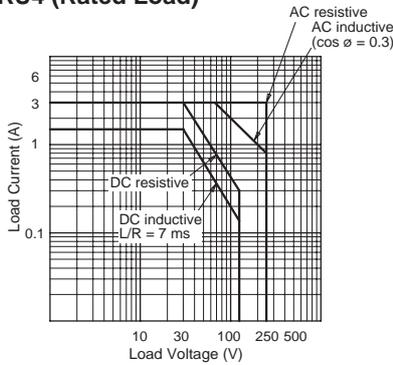

• RU4 (Maximum Load)

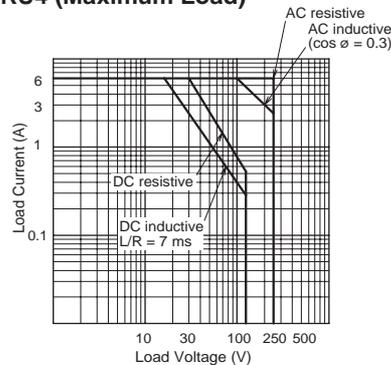

• RU42

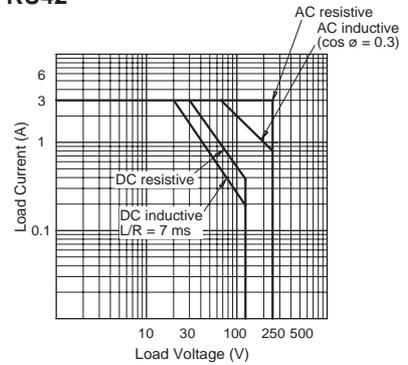

Ambient Temperature vs. Temperature Rise Curves

• RU4/RU42 (AC Coil, 50 Hz)

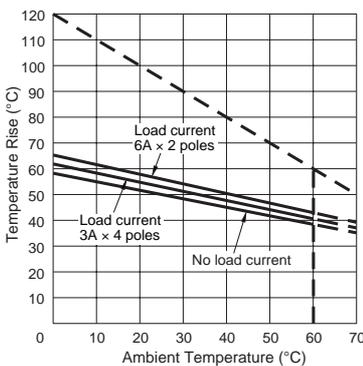

• RU4/RU42 (AC Coil, 60 Hz)

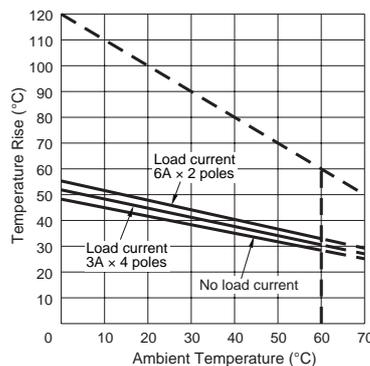

• RU4/RU42 (DC Coil)

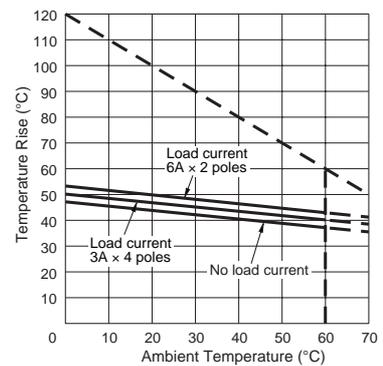

The above temperature rise curves show the characteristics when 100% the rated coil voltage is applied.

Load current 6A x 2 poles is for the RU4 types only.

The heat resistance of the coil is 120°C. The slant dashed line indicates the allowable temperature rise for the coil at different ambient temperatures.

RR series Power Relays

Heavy-duty power type relays Large capacity 10A — 1, 2, and 3 poles

- Available in pin and blade terminal styles.
- Options include an indicator, check button for test operation, and side flange.
- DIN rail, surface, and panel mount sockets are available for a wide variety of mounting applications.



Types

Termination	Type	Type No.					Coil Voltage Code *
		SPDT	DPDT	3PDT (Note)			
Pin Terminal	Basic	—	RR2P-U* ★	RR3P-U* ★	RR3PA-U* ★	AC6, AC12, AC24, AC50, AC100, AC110, AC115, AC120, AC200, AC220, AC230, AC240, DC6, DC12, DC24, DC48, DC110	
	With Indicator	—	RR2P-UL* ★	RR3P-UL* ★	RR3PA-UL* ★		
	With Check Button	—	RR2P-UC* ★	RR3P-UC* ★	RR3PA-UC* ★		
	With Indicator and Check Button	—	RR2P-ULC* ★	RR3P-ULC* ★	RR3PA-ULC* ★		
Blade Terminal	Basic	RR1BA-U*	RR2BA-U*	RR3B-U*	—		
	With Indicator	RR1BA-UL*	RR2BA-UL*	RR3B-UL*	—		
	With Check Button	RR1BA-UC*	RR2BA-UC*	RR3B-UC*	—		
	With Indicator and Check Button	RR1BA-ULC*	RR2BA-ULC*	RR3B-ULC*	—		
	Side Flange Type	RR1BA-US*	RR2BA-US*	RR3B-US*	—		

Note:

Both RR3P and RR3PA are 3PDT relays and have different terminal arrangements. See Internal Connection on page 17.

Type numbers marked with ★ in the table above are UL-recognized, CSA-certified, and TÜV-approved. Others are UL-recognized and CSA-certified.

Ordering Information

When ordering, specify the Type No. and coil voltage code.

(Example) **RR3P-U** **AC110**
 Type No. Coil Voltage Code

Coil Ratings

Rated Voltage (V)	Rated Current (mA) ±15% at 20°C		Coil Resistance (Ω) ±10% at 20°C	Operation Characteristics (against rated values at 20°C)		
	50Hz	60Hz		Max. Continuous Applied Voltage	Minimum Pickup Voltage	Dropout Voltage
AC (50/60Hz)	6	490	420	110%	80% maximum	30% minimum
	12	245	210			
	24	121	105			
	50	58	50			
	100	29	25			
	110	27	23			
	115	25	21.5			
	120	24	20.5			
	200	14.5	12.5			
	220	13.3	11.5			
	230	12.7	11			
240	12.1	10.5				
DC	6	240		110%	80% maximum	15% minimum
	12	120				
	24	60				
	48	30				
	110	13				

RR series Power Relays

Contact Ratings

Continuous Current	Maximum Contact Capacity				
	Allowable Contact Power		Rated Load		
	Resistive Load	Inductive Load	Voltage	Resistive Load	Inductive Load
10A	1650VA AC 300W DC	1100VA AC 150W DC	110V AC	10A	7.5A
			220V AC	7.5A	5A
			30V DC	10A	5A

Note: Inductive load for the rated load — $\cos \phi = 0.3$, $L/R = 7$ ms

• UL Ratings

Voltage	Resistive	General use	Horse Power Rating
240V AC	10A	7A	1/3 HP
120V AC	10A	7.5A	1/4 HP
30V DC	10A	7A	—

• CSA Ratings

Voltage	Resistive	General use
240V AC	10A	7A
120V AC	10A	7.5A
100V DC	—	0.5A
30V DC	10A	7.5A

• TÜV Ratings

240V AC	10A
30V DC	10A

AC: $\cos \phi = 1.0$, DC: $L/R = 0$ ms

Specifications

Contact Material	Silver	
Contact Resistance	*1	30 m Ω maximum
Minimum Applicable Load	24V DC, 10 mA; 5V DC, 20 mA (reference value)	
Operate Time	*2	25 ms maximum
Release Time	*2	25 ms maximum
Power Consumption (approx.)	AC: 3 VA (50 Hz), 2.5 VA (60 Hz) DC: 1.5W	
Insulation Resistance	100 M Ω minimum (500V DC megger)	
Dielectric Strength	Pin Terminal	Between live and dead parts: 1500V AC, 1 minute Between contact and coil: 1500V AC, 1 minute Between contacts of different poles: 1500V AC, 1 minute Between contacts of the same pole: 1000V AC, 1 minute
	Blade Terminal	Between live and dead parts: 2000V AC, 1 minute Between contact and coil: 2000V AC, 1 minute Between contacts of different poles: 2000V AC, 1 minute Between contacts of the same pole: 1000V AC, 1 minute
Operating Frequency	Electrical:	1800 operations/h maximum
	Mechanical:	18,000 operations/h maximum
Vibration Resistance	Damage limits:	10 to 55 Hz, amplitude 0.5 mm
	Operating extremes:	10 to 55 Hz, amplitude 0.5 mm
Shock Resistance	Damage limits:	1000 m/s ²
	Operating extremes:	100 m/s ²
Electrical Life	200,000 operations (220V AC, 5A)	
Mechanical Life	10,000,000 operations	
Operating Temperature	*3	-25 to +40°C (no freezing)
Operating Humidity	5 to 85% RH (no condensation)	
Weight (approx.) (Basic type)	RR2P: 90g, RR3P/RR3PA: 96g, RR1BA/RR2BA/RR3B: 82g	

Note: Above values are initial values.

*1: Measured using 5V DC, 1A voltage drop method

*2: Measured at the rated voltage (at 20°C), excluding contact bouncing

*3: For use under different temperature conditions, refer to Continuous Load Current vs. Operating Temperature Curve.

Internal Connection (Bottom View)

• Basic Type

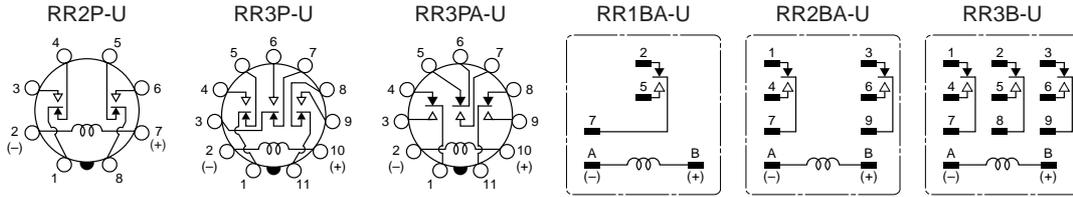

• With Check Button

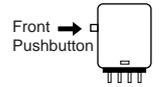

Contacts can be operated by pressing the check button. Press the button quickly to prevent arcing.

• With Indicator (-UL type)

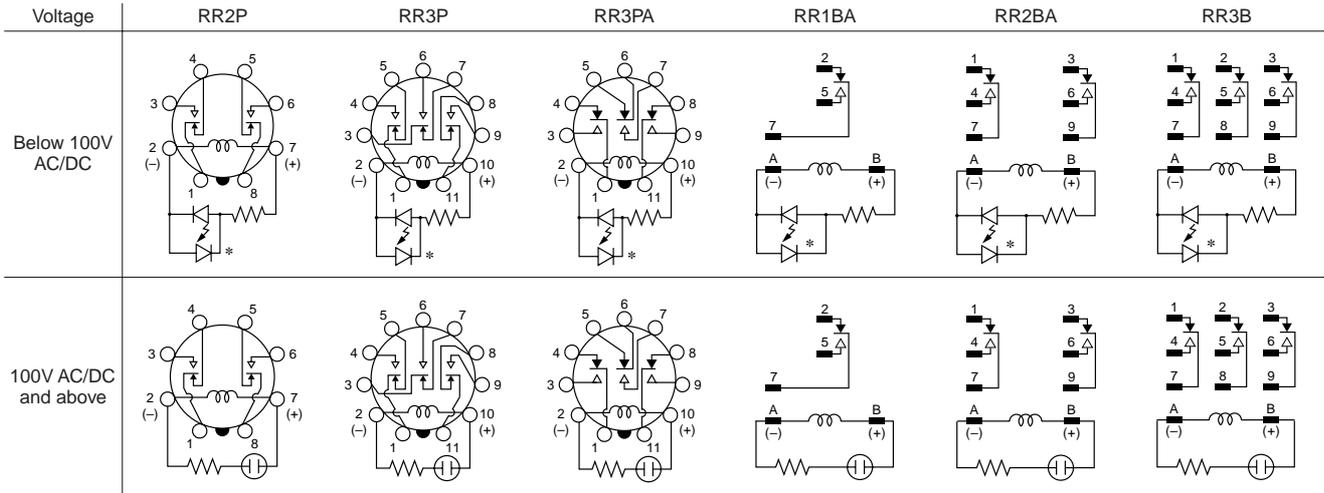

When the relay is energized, the indicator goes on.

* The LED protection diode is not contained in relays for below 100V DC.

Characteristics (Reference Data)

• Maximum Switching Capacity

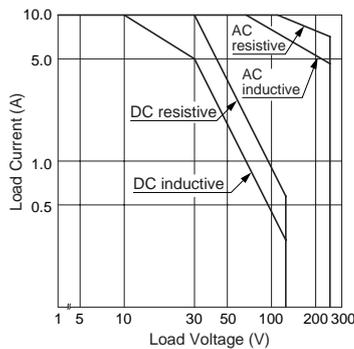

• Continuous Load Current vs. Operating Temperature Curve (Basic Type, With Check Button, and Side Flange Type)

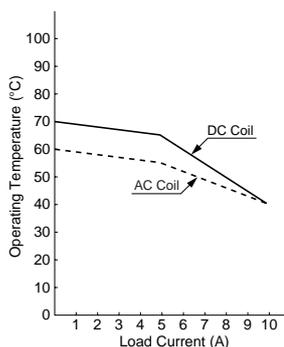

• Electrical Life Curve

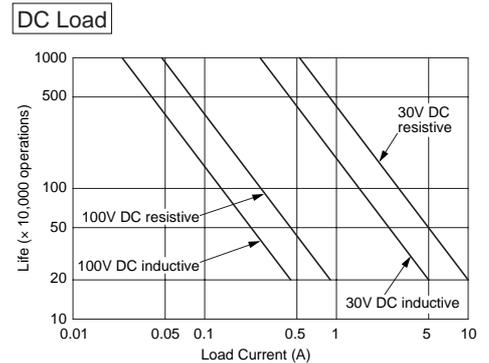
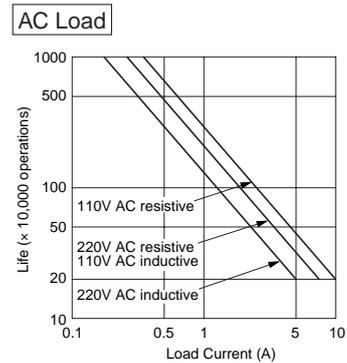

RR Series Power Relays

Dimensions

RR2P-U/RR2P-UL



(Photo: RR2P-U)

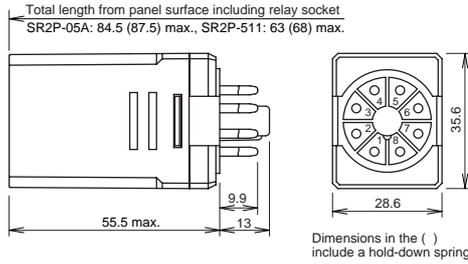

• Applicable Socket and Hold-down Spring

Socket		Type No.	Hold-down Spring
Mounting Style			
DIN Rail Mount Socket		SR2P-05A SR2P-05C SR2P-06A	SR2B-02F1 SFA-202
Panel Mount Socket	w/Solder Terminals	SR2P-511	SR3P-01F1
	w/Wire Wrap Terminals	SR2P-70	



RR3P-U/RR3P-UL/ RR3PA-U/RR3PA-UL



(Photo: RR3P-U)

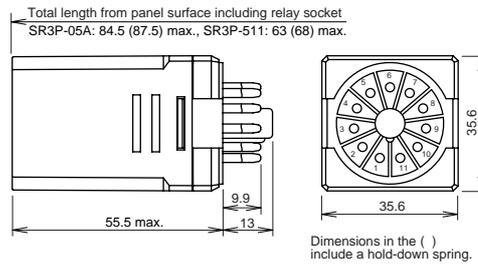

• Applicable Socket and Hold-down Spring

Socket		Type No.	Hold-down Spring
Mounting Style			
DIN Rail Mount Socket		SR3P-05A SR3P-05C SR3P-06A	SR3B-02F1 SFA-202
Panel Mount Socket	w/Solder Terminals	SR3P-511	SR3P-01F1
	w/Wire Wrap Terminals	SR3P-70	



RR1BA-U/RR1BA-UL/ RR2BA-U/RR2BA-UL/ RR3B-U/RR3B-UL



(Photo: RR3B-U)

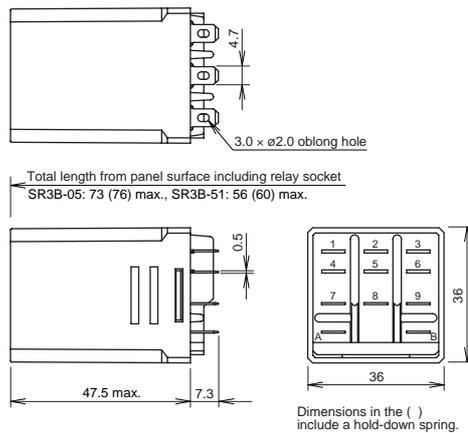

• Applicable Socket and Hold-down Spring

Socket		Type No.	Hold-down Spring
Mounting Style			
DIN Rail Mount Socket		SR3B-05	SR3B-02F1 SFA-202
Panel Mount Socket		SR3B-51	SR3B-02F1



RR1BA-US RR2BA-US RR3B-US



(Photo: RR3B-US)

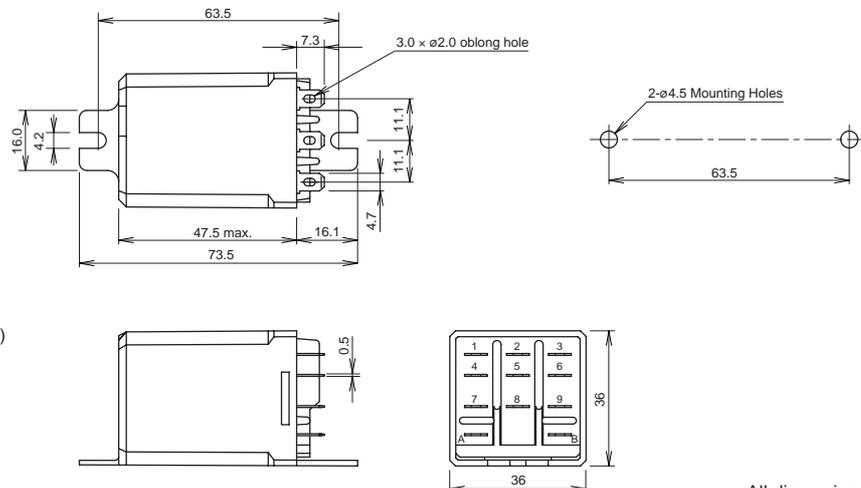

All dimensions in mm.



RH series Power Relays

SPDT through 4PDT, 10A contacts Midget power type relays

The RH series are miniature power relays with a large capacity. The RH relays feature 10A contact capacity as large as the RR series and the same size as IDEC's miniature relays. The compact size saves space.

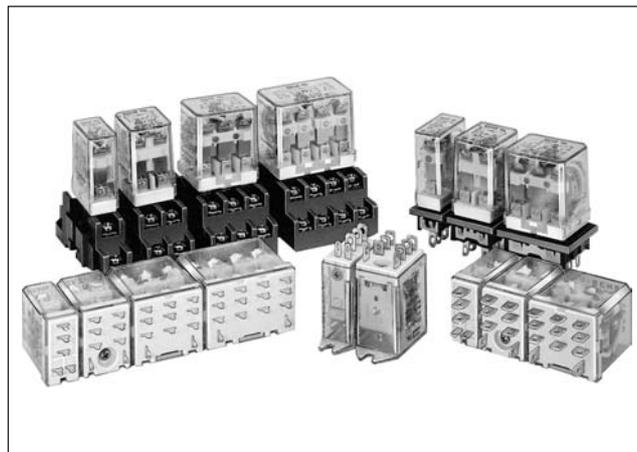

Types

Termination	Type	SPDT		DPDT		
		Type No.	Coil Voltage Code *	Type No.	Coil Voltage Code *	
Plug-in Terminal	Basic	RH1B-U* ★	AC6, AC12, AC24, AC50, AC100, AC110, AC115, AC120, AC200, AC220, AC230, AC240	RH2B-U* ★	AC6, AC12, AC24, AC50, AC100-110, AC110-120, AC200-220, AC220-240	
	With Indicator	RH1B-UL* ★		RH2B-UL* ★		
	With Check Button	—		RH2B-UC* ★		
	With Indicator and Check Button	—	DC6, DC12, DC24, DC48, DC100, DC110	RH2B-ULC* ★	DC6, DC12, DC24, DC48, DC100-110	
	Top Bracket Mounting	RH1B-UT* ★		RH2B-UT* ★		
	With Diode (DC coil only)	RH1B-UD* ★	DC6, DC12, DC24, DC48, DC100, DC110	RH2B-UD* ★	DC6, DC12, DC24, DC48, DC100-110	
	With Indicator and Diode (DC coil only)	—		RH2B-ULD* ★		
	With Resistor and Capacitor (100V AC and over)	—		RH2B-R*		AC100-110, AC110-120, AC200-220, AC220-240
	With Indicator and RC (100V AC and over)	—		RH2B-LR*		
PC Board Terminal	Basic	RH1V2-U* ★	AC6, AC12, AC24, AC50, AC100, AC110, AC115, AC120, AC200, AC220, AC230, AC240 DC6, DC12, DC24, DC48, DC100, DC110	RH2V2-U* ★	AC6, AC12, AC24, AC50, AC100-110, AC110-120, AC200-220, AC220-240 DC6, DC12, DC24, DC48, DC100-110	
	With Indicator	—		RH2V2-UL* ★		
	With Diode (DC coil only)	RH1V2-UD* ★	DC6, DC12, DC24, DC48, DC100, DC110	RH2V2-UD* ★	DC6, DC12, DC24, DC48, DC100-110	

Type numbers marked with ★ in the table above are UL-recognized, CSA-certified, and TÜV-approved.

Ordering Information

When ordering, specify the Type No. and coil voltage code.

(Example) **RH2B-U** **AC100-110**
 Type No. Coil Voltage Code

RH series Power Relays

Types

Termination	Type	3PDT		4PDT	
		Type No.	Coil Voltage Code *	Type No.	Coil Voltage Code *
Plug-in Terminal	Basic	RH3B-U* ★	AC6, AC12, AC24, AC50, AC100, AC110, AC115, AC120, AC200, AC220, AC230, AC240	RH4B-U* ★	AC6, AC12, AC24, AC50, AC100, AC110, AC115, AC120, AC200, AC220, AC230, AC240
	With Indicator	RH3B-UL* ★		RH4B-UL* ★	
	With Check Button	RH3B-UC* ★		RH4B-UC* ★	
	With Indicator and Check Button	RH3B-ULC* ★		RH4B-ULC* ★	
	Top Bracket Mounting	RH3B-UT* ★	RH4B-UT* ★	DC6, DC12, DC24, DC48, DC100, DC110	DC6, DC12, DC24, DC48, DC100, DC110
	With Diode (DC coil only)	RH3B-D*	DC6, DC12, DC24, DC48, DC100, DC110	RH4B-UD* ★	DC6, DC12, DC24, DC48, DC100, DC110
	With Indicator and Diode (DC coil only)	RH3B-LD*		RH4B-LD*	
PC Board Terminal	Basic	RH3V2-U* ★	AC6, AC12, AC24, AC50, AC100, AC110, AC115, AC120, AC200, AC220, AC230, AC240	RH4V2-U* ★	AC6, AC12, AC24, AC50, AC100, AC110, AC115, AC120, AC200, AC220, AC230, AC240
	With Indicator	RH3V2-UL* ★		RH4V2-UL* ★	
	With Diode (DC coil only)	RH3V2-D*	DC6, DC12, DC24, DC48, DC100, DC110	RH4V2-UD* ★	DC6, DC12, DC24, DC48, DC100, DC110

Type numbers marked with ★ in the table above are UL-recognized, CSA-certified, and TÜV-approved.

Ordering Information

When ordering, specify the Type No. and coil voltage code.

(Example) **RH3B-U** **AC110**
 Type No. Coil Voltage Code

Coil Ratings

	Rated Voltage (V)				Rated Current (mA) ±15% at 20°C								Coil Resistance (Ω) ±10% at 20°C				Operation Characteristics (against rated values at 20°C)		
	SPDT	DPDT	3PDT	4PDT	50Hz				60Hz				SPDT	DPDT	3PDT	4PDT	Max. Continuous Applied Voltage	Min. Pickup Voltage	Dropout Voltage
					SPDT	DPDT	3PDT	4PDT	SPDT	DPDT	3PDT	4PDT							
AC (60/60Hz)	6	6	6	6	170	240	330	387	150	200	280	330	18.8	9.4	6.4	5.4	110%	80% maximum	30% minimum
	12	12	12	12	86	121	165	196	75	100	140	165	76.8	39.3	25.3	21.2			
	24	24	24	24	42	60.5	81	98	37	50	70	83	300	153	103	84.5			
	50	50	50	50	20.5	28.9	39.5	47	18	24	34	40	1,280	680	460	340			
	100	100-110	100	100	10.5	10.3-11.8	20	23.5	9	9.1-10.0	17	20	5,220	3,360	1,940	1,560			
	110	—	110	110	9.6	—	18.1	21.6	8.4	—	15.5	18.2	6,950	—	2,200	1,800			
	115	110-120	115	115	8.9	9.4-10.8	17.1	20.8	7.8	8.0-9.2	14.8	17.5	7,210	4,290	2,620	1,910			
	120	—	120	120	8.6	—	16.4	19.5	7.5	—	14.2	16.5	8,100	—	2,770	2,220			
	200	200-220	200	200	5.6	5.1-5.9	9.8	11.8	4.9	4.3-5.0	8.5	10	21,442	13,690	8,140	6,360			
	220	—	220	220	4.7	—	8.8	10.7	4.1	—	7.7	9.1	25,892	—	10,800	7,360			
230	220-240	230	230	4.7	4.7-5.4	8.5	10.3	4.1	4.0-4.6	7.4	8.7	26,710	18,820	11,500	8,520				
240	—	240	240	4.9	—	8.2	9.8	4.3	—	7.1	8.3	26,710	—	12,100	9,120				
DC	SPDT	DPDT	3PDT	4PDT	SPDT	DPDT	3PDT	4PDT	SPDT	DPDT	3PDT	4PDT	SPDT	DPDT	3PDT	4PDT	110%	80% maximum	10% minimum
	6	6	6	6	128	150	240	250	47	40	25	24							
	12	12	12	12	64	75	120	125	188	160	100	96							
	24	24	24	24	32	36.9	60	62	750	650	400	388							
	48	48	48	48	18	18.5	30	31	2,660	2,600	1,600	1,550							
	100	100-110	100	100	10	8.2-9.0	14.5	15	10,000	12,250	6,900	6,670							
110	—	110	110	8	—	12.8	15	13,800	—	8,600	7,340								

RH Series Power Relays

Contact Ratings

Type	Continuous Current	Maximum Contact Capacity				
		Allowable Contact Power		Rated Load		
		Resistive Load	Inductive Load	Voltage (V)	Res. Load	Ind. Load
SPDT	10A	1540VA AC 300W DC	990VA AC 210W DC	110 AC	10A	7A
				220 AC	7A	4.5A
				30 DC	10A	7A
DPDT 3PDT 4PDT	10A	1650VA AC 300W DC	1100VA AC 225W DC	110 AC	10A	7.5A
				220 AC	7.5A	5A
				30 DC	10A	7.5A

Note: Inductive load for the rated load — $\cos \phi = 0.3$, L/R = 7 ms

TÜV Ratings

Voltage	RH1	RH2	RH3	RH4
240V AC	10A	10A	7.5A	7.5A
30V DC	10A	10A	10A	10A

AC: $\cos \phi = 1.0$, DC: L/R = 0 ms

Specifications

Contact Material	Silver cadmium oxide	
Contact Resistance *1	50 mΩ maximum	
Minimum Applicable Load	24V DC, 30 mA; 5V DC, 100 mA (reference value)	
Operate Time *2	SPDT DPDT	20 ms maximum
	3PDT 4PDT	25 ms maximum
Release Time *2	SPDT DPDT	20 ms maximum
	3PDT 4PDT	25 ms maximum
Power Consumption (approx.)	SPDT	AC: 1.1 VA (50 Hz), 1 VA (60 Hz) DC: 0.8W
	DPDT	AC: 1.4 VA (50 Hz), 1.2 VA (60 Hz) DC: 0.9W
	3PDT	AC: 2 VA (50 Hz), 1.7 VA (60 Hz) DC: 1.5W
	4PDT	AC: 2.5 VA (50 Hz), 2 VA (60 Hz) DC: 1.5W
Insulation Resistance	100 MΩ minimum (500V DC megger)	
Dielectric Strength	SPDT	Between live and dead parts: 2000V AC, 1 minute *3 Between contact and coil: 2000V AC, 1 minute Between contacts of the same pole: 1000V AC, 1 minute
	DPDT 3PDT 4PDT	Between live and dead parts: 2000V AC, 1 minute Between contact and coil: 2000V AC, 1 minute Between contacts of different poles: 2000V AC, 1 minute Between contacts of the same pole: 1000V AC, 1 minute
Operating Frequency	Electrical:	1800 operations/h maximum
	Mechanical:	18,000 operations/h maximum
Vibration Resistance	Damage limits:	10 to 55 Hz, amplitude 0.5 mm
	Operating extremes:	10 to 55 Hz, amplitude 0.5 mm
Shock Resistance	Damage limits:	1000 m/s ²
	Operating extremes:	200 m/s ² (SPDT, DPDT) 100 m/s ² (3PDT, 4PDT)
Electrical Life	DPDT	500,000 operations minimum (110V AC, 1A)
	SPDT 3PDT 4PDT	200,000 operations minimum (110V AC, 1A)
	Mechanical Life	50,000,000 operations minimum
Operating Temperature *4	SPDT	-25 to +50°C (no freezing)
	DPDT 3PDT 4PDT	-25 to +40°C (no freezing)
	Operating Humidity	45 to 85% RH (no condensation)
	Weight (approx.)	SPDT: 24g, DPDT: 37g, 3PDT: 50g, 4PDT: 74g

Note: Above values are initial values.

*1: Measured using 5V DC, 1A voltage drop method

*2: Measured at the rated voltage (at 20°C), excluding contact bouncing
Release time of relays with diode: 40 ms maximum

*3: Relays with indicator or diode: 1000V AC, 1 minute

*4: For use under different temperature conditions, refer to Continuous Load Current vs. Operating Temperature Curve. The operating temperature range of relays with indicator or diode is -25 to +40°C.

UL Ratings

Voltage	Resistive			General use			Horse Power Rating		
	RH1 RH2	RH3	RH4	RH1 RH2	RH3	RH4	RH1 RH2	RH3	RH4
240V AC	10A	7.5A	7.5A	7A	6.5A	5A	1/3 HP	1/3 HP	—
120V AC	—	10A	10A	—	7.5A	7.5A	1/6 HP	1/6 HP	—
30V DC	10A	10A	—	7A	—	—	—	—	—
28V DC	—	—	10A	—	—	—	—	—	—

CSA Ratings

Voltage	Resistive				General use				Horse Power Rating
	RH1	RH2	RH3	RH4	RH1	RH2	RH3	RH4	
240V AC	10A	10A	—	7.5A	7A	7A	7A	5A	1/3 HP
120V AC	10A	10A	10A	10A	7.5A	7.5A	—	7.5A	1/6 HP
30V DC	10A	10A	10A	10A	7A	7.5A	—	—	—

RH series Power Relays

Internal Connection (Bottom View)

• Basic Type

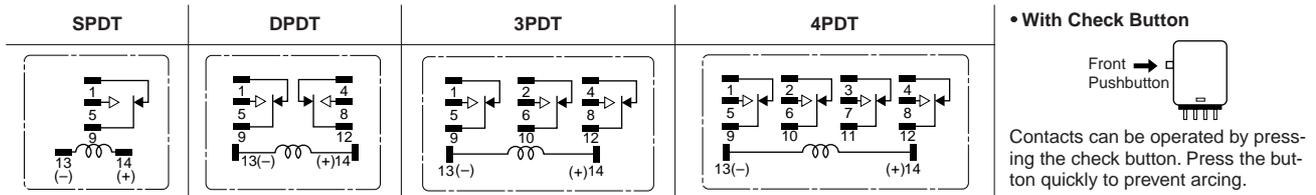

• With Indicator (-L type)

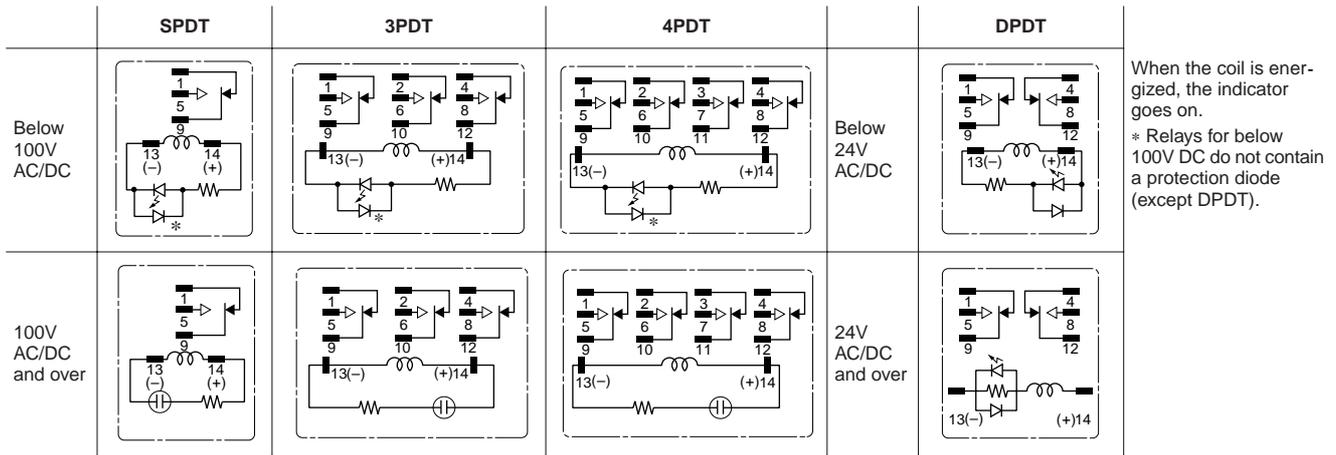

• With Diode (-D type)

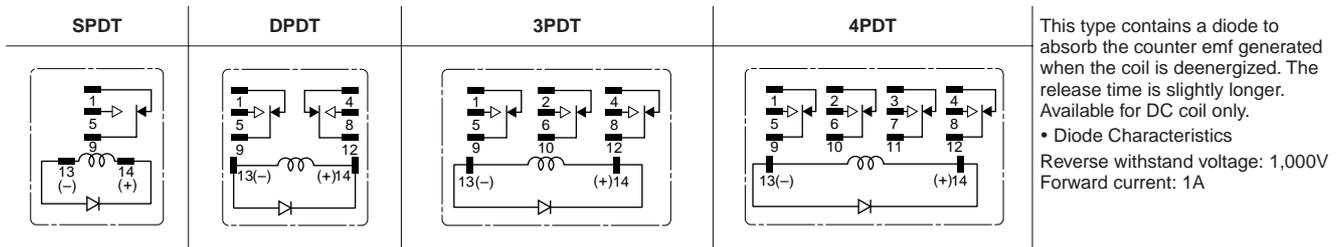

• With Indicator and Diode (-LD type)

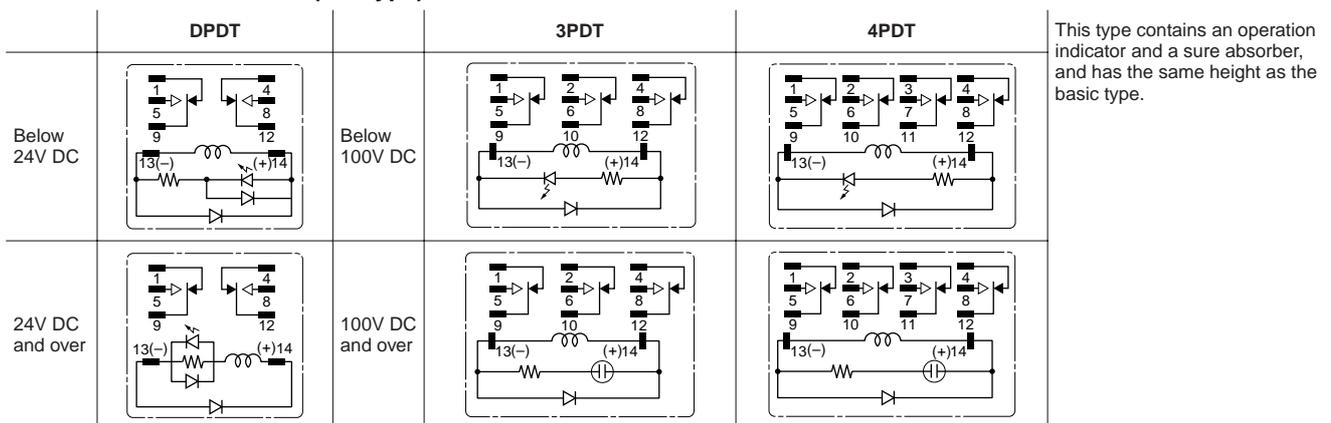

• With Resistor and Capacitor (-R type)

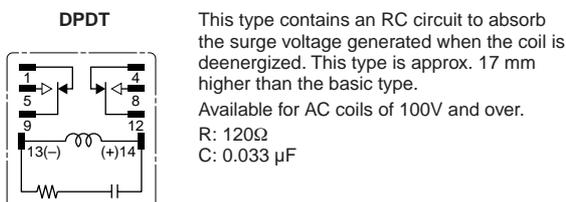

• With Indicator and RC (-LR type)

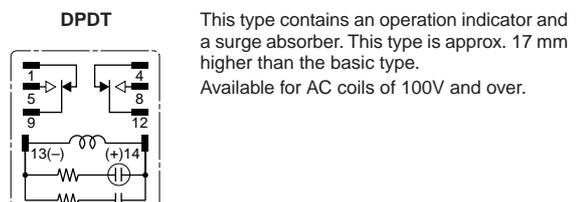

RH series Power Relays

Characteristics (Reference Data)

• Maximum Switching Capacity

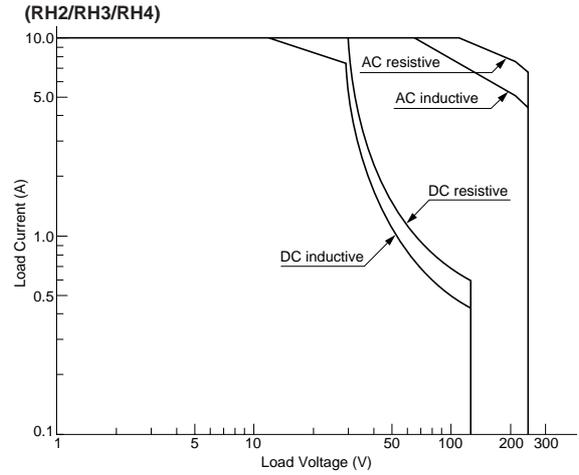
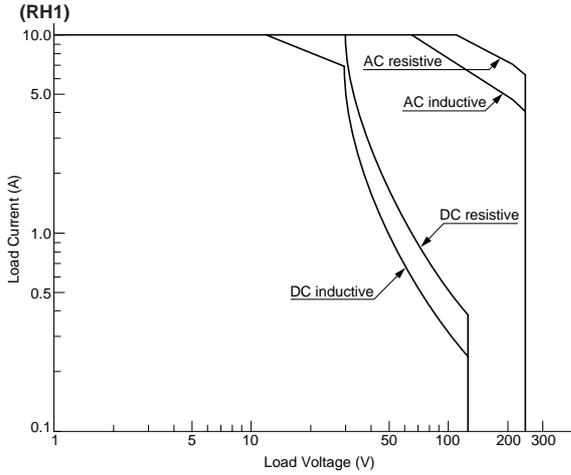

• Electrical Life Curve

AC Load

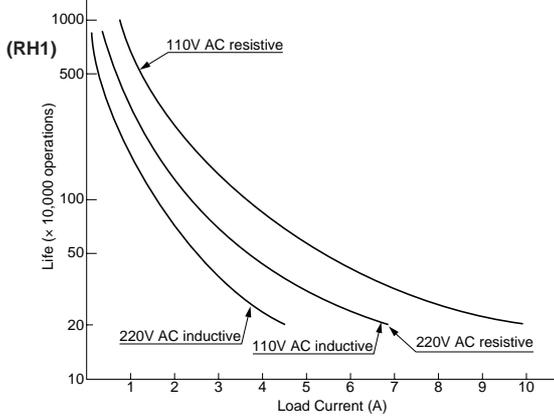

DC Load

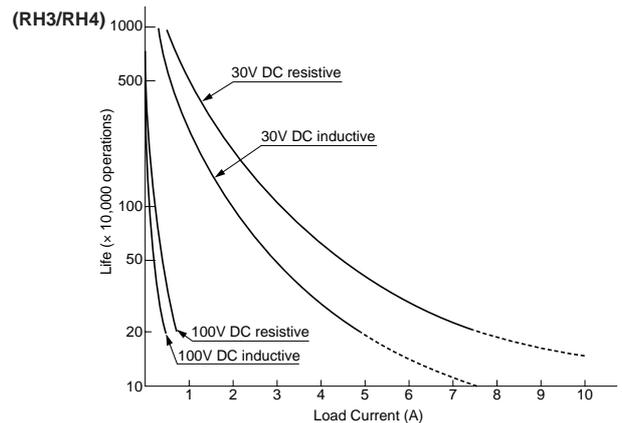
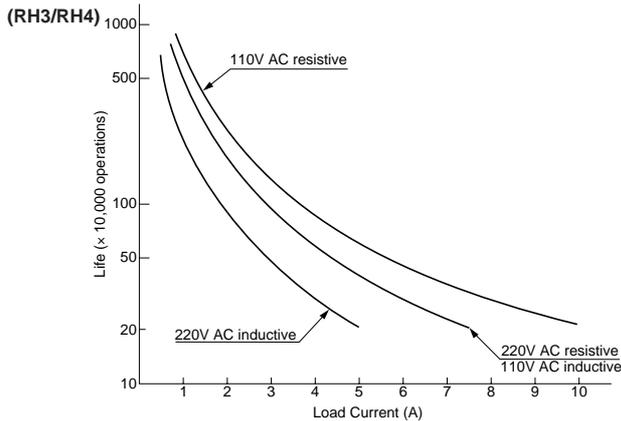
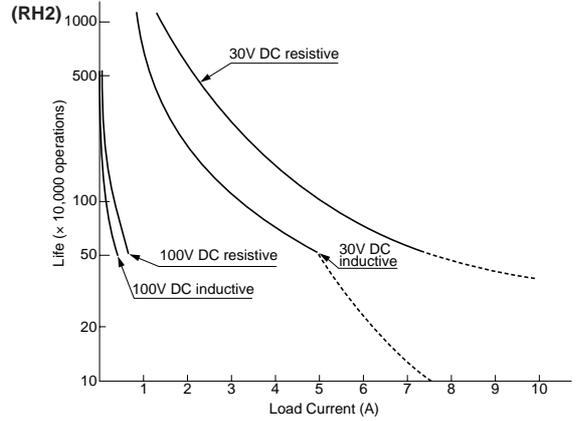
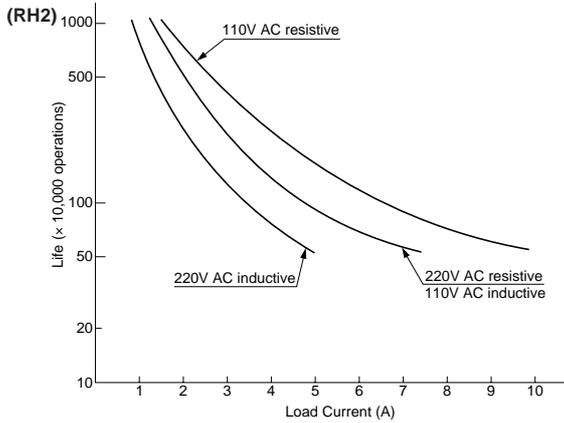
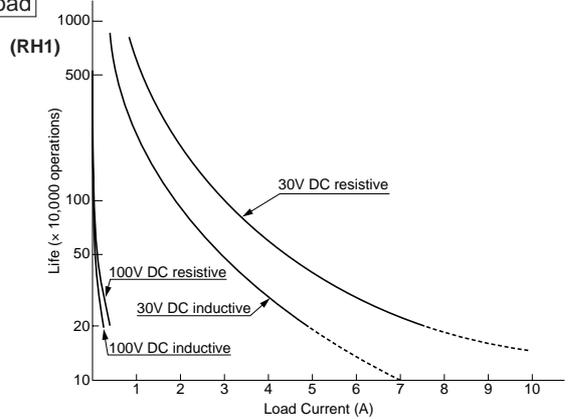

RH series Power Relays

• Continuous Load Current vs. Operating Temperature Curve (Basic Type, With Check Button, and Top Bracket Mounting Type)

(RH1)

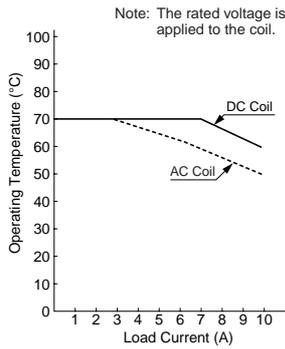

(RH2)

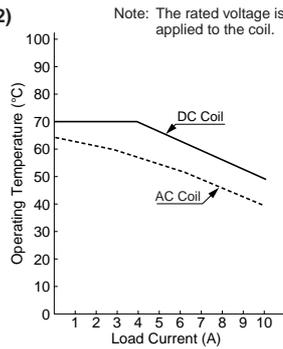

(RH3/RH4)

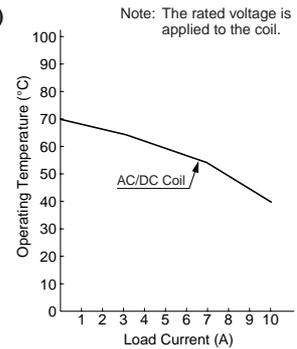

Dimensions

RH1B-U/RH1B-UL/RH1B-UD



(Photo: RH1B-U)

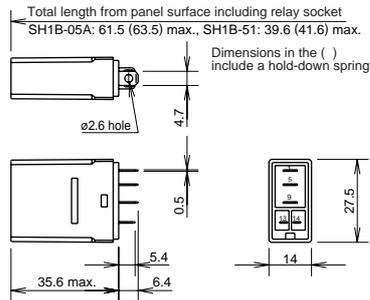

• Applicable Socket and Hold-down Spring

Mounting Style	Socket	
	Type No.	Hold-down Spring
DIN Rail Mount Socket	SH1B-05A	SY2S-02F1
	SH1B-05C	SFA-101 SFA-202
Panel Mount Socket	SH1B-51	SY4S-51F1
PC Board Mount Socket	SH1B-62	SFA-301
		SFA-302

RH2B-U/RH2B-UL/RH2B-UD/RH2B-ULD



(Photo: RH2B-U)

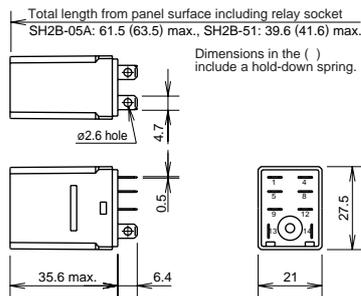

• Applicable Socket and Hold-down Spring

Mounting Style	Socket	
	Type No.	Hold-down Spring
DIN Rail Mount Socket	SH2B-05A	SY4S-02F1
	SH2B-05C	SFA-101 SFA-202
	SH2B-05D	SFA-502
Panel Mount Socket	SH2B-51	SY4S-51F1 (SY4S-02F1) SFA-301 SFA-302
PC Board Mount Socket	SH2B-62	SY4S-51F1 (SY4S-02F1)

Note: (SY4S-02F1) is for the relay with check button.

RH3B-U/RH3B-UL/RH3B-D/RH3B-LD



(Photo: RH3B-U)

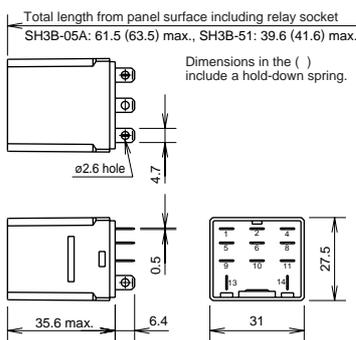

• Applicable Socket and Hold-down Spring

Mounting Style	Socket	
	Type No.	Hold-down Spring
DIN Rail Mount Socket	SH3B-05A	SH3B-05F1
	SH3B-05C	SFA-101 SFA-202
Panel Mount Socket	SH3B-51	SY4S-51F1 (SH3B-05F1)
PC Board Mount Socket	SH3B-62	SFA-301 SFA-302

Note: (SH3B-05F1) is for the relay with check button.

RH4B-U/RH4B-UL/RH4B-UD/RH4B-LD



(Photo: RH4B-U)

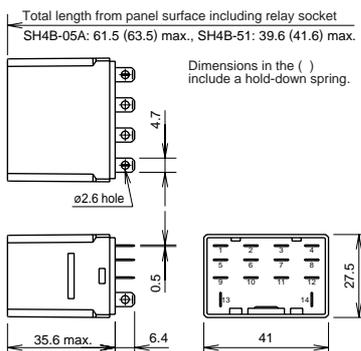

• Applicable Socket and Hold-down Spring

Mounting Style	Socket	
	Type No.	Hold-down Spring
DIN Rail Mount Socket	SH4B-05A	SH4B-02F1
	SH4B-05C	SFA-101 SFA-202
Panel Mount Socket	SH4B-51	SY4S-51F1 (SH4B-02F1)
PC Board Mount Socket	SH4B-62	SFA-301
		SFA-302

Note 1: Use two SY4S-51F1 hold-down springs for the SH4B-51 and SH4B-62 sockets.

Note 2: (SH4B-02F1) is for the relay with check button.

RH Series Power Relays

RH2B-R/RH2B-LR



(Photo: RH2B-R)

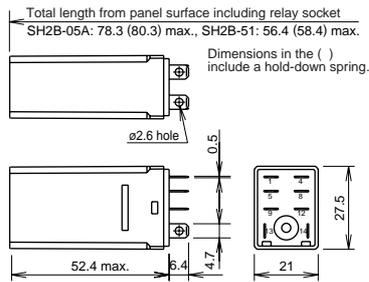

• Applicable Socket and Hold-down Spring

Mounting Style	Socket	
	Type No.	Hold-down Spring
DIN Rail Mount Socket	SH2B-05A SH2B-05C	SFA-202
Panel Mount Socket	SH2B-51	SFA-302

Note: Hold-down spring is not available for mounting the RH2B-R on a PC board mount socket.

RH1B-UT

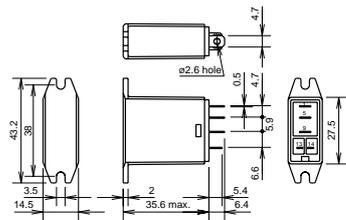

RH2B-UT

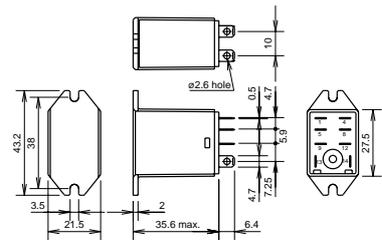

RH3B-UT

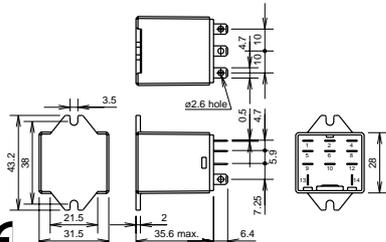

RH4B-UT

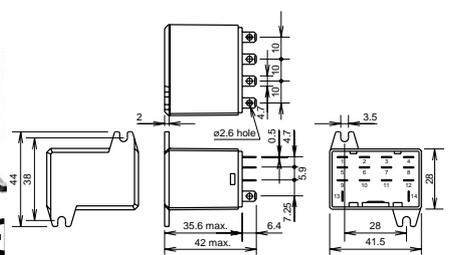

RH1V2-U/RH1V2-UD



(Photo: RH1V2-U)

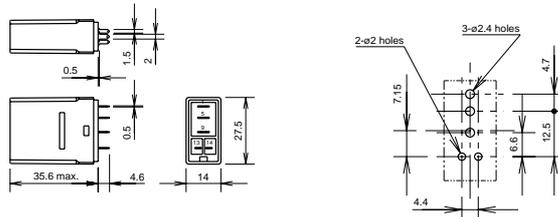

RH2V2-U/RH2V2-UL/ RH2V2-UD



(Photo: RH2V2-U)

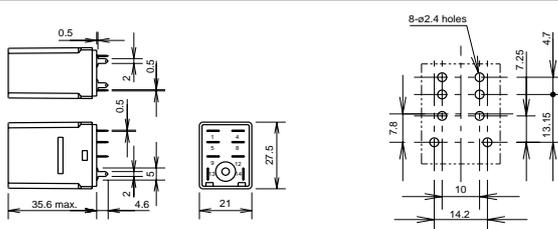

RH3V2-U/RH3V2-UL/ RH3V2-D



Photo: RH3V2-U)

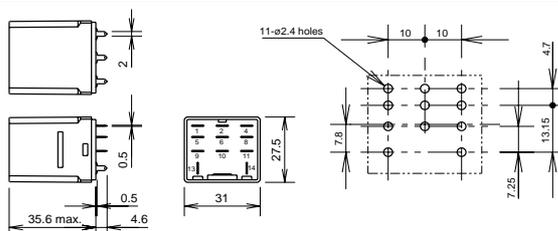

RH4V2-U/RH4V2-UL/ RH4V2-UD



(Photo: RH4V2-U)

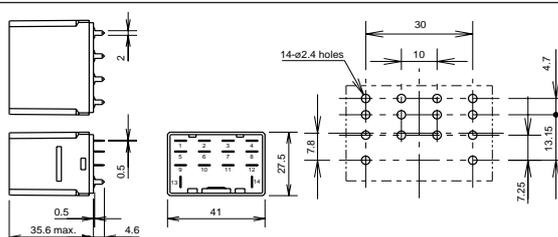

All dimensions in mm.

RM Series Miniature Relays

DPDT contacts (5A) Plug-in and PC board terminal styles

- Compact miniature size saves space
- Options include indicators and check buttons.

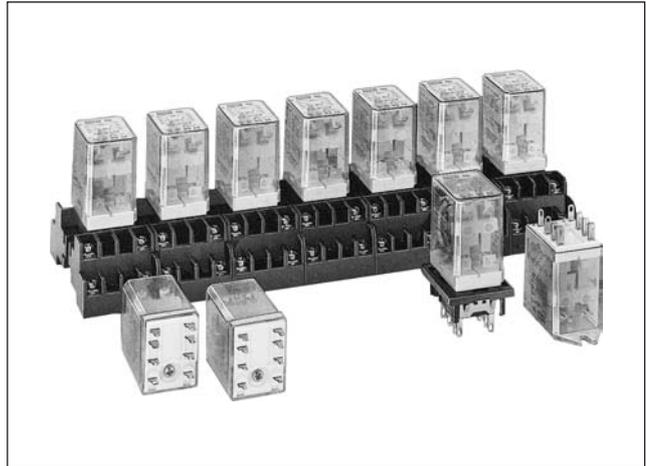

Types

Type	Plug-in Terminal		PC Board Terminal	
	Type No.	Coil Voltage Code *	Type No.	Coil Voltage Code *
Basic	RM2S-U* ★	AC6, AC12, AC24, AC50, AC100-110, AC110-120, AC200-220, AC220-240 DC6, DC12, DC24, DC48, DC100-110	RM2V-U* ★	AC6, AC12, AC24, AC50, AC100-110, AC110-120, AC200-220, AC220-240
With Indicator	RM2S-UL* ★		RM2V-UL* ★	
With Check Button	RM2S-UC* ★		—	—
Top Bracket Mounting Type	RM2S-UT* ★		—	—
With Diode (DC coil only)	RM2S-UD* ★	DC6, DC12, DC24, DC48, DC100-110	—	—
With Indicator and Diode (DC coil only)	RM2S-ULD* ★		—	—

Type numbers marked with ★ in the table above are UL-recognized, CSA-certified, and TÜV-approved.

Ordering Information

When ordering, specify the Type No. and coil voltage code.

(Example) **RM2S-U** **AC100-110**
Type No. Coil Voltage Code

Coil Ratings

Rated Voltage (V)	Rated Current (mA) ±15% at 20°C		Coil Resistance (Ω) ±10% at 20°C	Operation Characteristics (against rated values at 20°C)		
	50Hz	60Hz		Max. Continuous Applied Voltage	Min. Pickup Voltage	Dropout Voltage
AC (50/60Hz)	6	240	200	110%	80% maximum	30% minimum
	12	121	100			
	24	60.5	50			
	50	28.9	24			
	100-110	10.3-11.8	9.1-10.0			
	110-120	9.4-10.8	8.2-9.2			
	200-220	5.1-5.9	4.3-5.0			
	220-240	4.7-5.4	4.0-4.6			
DC	6	150		110%	80% maximum	10% minimum
	12	75				
	24	36.9				
	48	18.5				
	100-110	8.2-9.0				

RM Series Miniature Relays

Contact Ratings

Continuous Current	Maximum Contact Capacity				
	Allowable Contact Power		Rated Load		
	Resistive Load	Inductive Load	Voltage	Res. Load	Ind. Load
5A	1100VA AC 150W DC	440VA AC 75W DC	110V AC	5A	2.5A
			220V AC	5A	2A
			30V DC	5A	2.5A

Note: Inductive load for the rated load — $\cos \phi = 0.3$, L/R = 7 ms

• UL Ratings

Voltage	Resistive	General use
240V AC	5A	2A
120V AC	—	2.5A
100V DC	0.4A	—
30V DC	5A	—

• CSA Ratings

Voltage	Resistive	General use
240V AC	5A	2A
120V AC	5A	2.5A
100V DC	—	0.4A
30V DC	5A	2.5A

• TÜV Ratings

240V AC	5A
30V DC	5A

AC: $\cos \phi = 1.0$, DC: L/R = 0 ms

Specifications

Contact Material	Silver
Contact Resistance	30 m Ω maximum *1
Minimum Applicable Load	24V DC, 10 mA; 5V DC, 20 mA (reference value)
Operate Time	20 ms maximum *2
Release Time	20 ms maximum *2
Power Consumption (approx.)	AC: 1.4 VA (50 Hz), 1.2 VA (60 Hz) DC: 0.9W
Insulation Resistance	100 M Ω minimum (500V DC megger)
Dielectric Strength	Between live and dead parts: 2000V AC, 1 minute *3 Between contact and coil: 2000V AC, 1 minute Between contacts of different poles: 2000V AC, 1 minute Between contacts of the same pole: 1000V AC, 1 minute
Operating Frequency	Electrical: 1800 operations/h maximum Mechanical: 18,000 operations/h maximum
Temperature Rise	Coil: 85°C maximum, Contact: 65°C maximum
Vibration Resistance	Damage limits: 10 to 55 Hz, amplitude 0.5 mm Operating extremes: 10 to 55 Hz, amplitude 0.5 mm
Shock Resistance	Damage limits: 1000 m/s ² Operating extremes: 200 m/s ²
Electrical Life	500,000 operations (220V AC, 5A)
Mechanical Life	50,000,000 operations
Operating Temperature	-25 to +45°C (no freezing) *4
Operating Humidity	45 to 85% RH (no condensation)
Weight (approx.)	35g

Note: Above values are initial values.

*1: Measured using 5V DC, 1A voltage drop method

*2: Measured at the rated voltage (at 20°C), excluding contact bouncing
Release time of relays with diode: 40 ms maximum

*3: Relays with indicator or diode: 1000V AC, 1 minute

*4: For use under different temperature conditions, refer to Continuous Load Current vs. Operating Temperature Curve. The operating temperature range of relays with indicator or diode is -25 to +40°C.

Characteristics (Reference Data)

• Maximum Switching Capacity

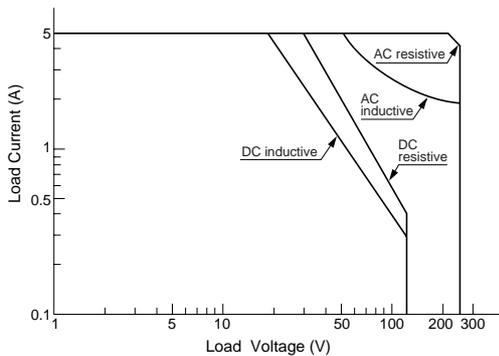

• Electrical Life Curve

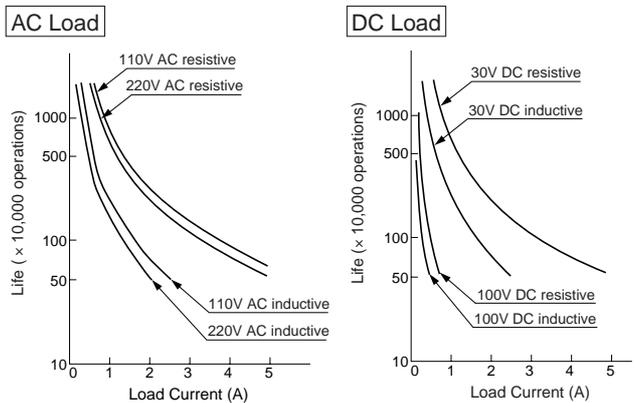

• Continuous Load Current vs. Operating Temperature Curve (Basic Type, With Check Button, and Top Bracket Mounting Type)

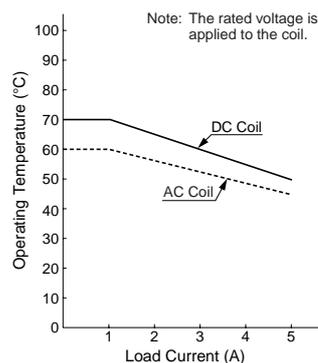

RM Series Miniature Relays

Internal Connection (Bottom View)

• Basic Type

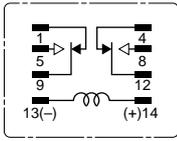

• With Check Button

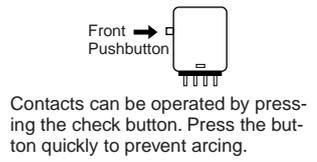

• With Diode (-D type)

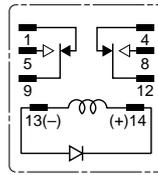

This type contains a diode to absorb the counter emf generated when the coil is deenergized. The release time is slightly longer.

- Diode Characteristics
Reverse withstand voltage: 1,000V
Forward current: 1A

• With Indicator (-L type)

Below 24V AC/DC 24V AC/DC and over

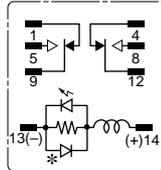
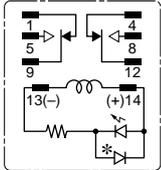

When the coil is energized, the indicator goes on.

* The LED protection diode is not contained in DPDT relays for below 100V DC.

• With Indicator and Diode (-LD type)

Below 24V DC 24V DC and over

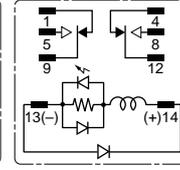
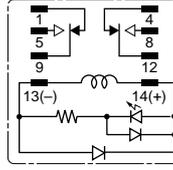

This type contains an operation indicator and a surge absorber, and has the same height as the basic type.

Dimensions

• Plug-in Type (Solder Terminal)

RM2S-U/RM2S-UL
RM2S-UD/RM2S-ULD



(Photo: RM2S-U)

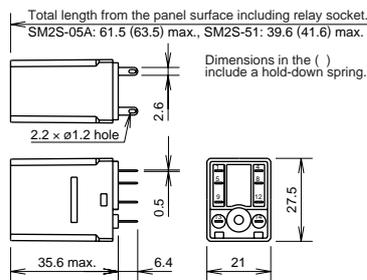

• Applicable Socket and Hold-down Spring

Socket		Hold-down Spring
Mounting Style	Type No.	
DIN Rail Mount Socket	SM2S-05A	SY4S-02F1
	SM2S-05C	SFA-101
	SM2S-05D	SFA-502
Panel Mount Socket	SM2S-51	SY4S-51F1 (SY4S-02F1)
PC Board Mount Socket	SM2S-61	SFA-301
	SM2S-62	SFA-302

Note: (SY4S-02F1) is for the relay with check button.

• PC Board Terminal Type

RM2V-U/RM2V-UL



(Photo: RM2V-U)

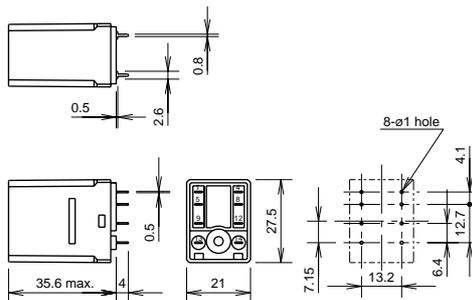

• Top Bracket Mounting Type (Solder Terminal)

RM2S-UT

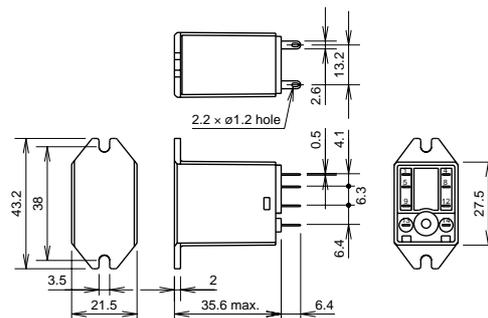

All dimensions in mm.

RY Series Miniature Relays

DPDT (3A) and 4PDT (5A) contacts Bifurcated contacts are also available

The RY series are general purpose miniature relays with a 3A or 5A contact capacity. A wide variety of terminals styles and coil voltages meet a wide range of applications.

All 4PDT types have arc barriers.

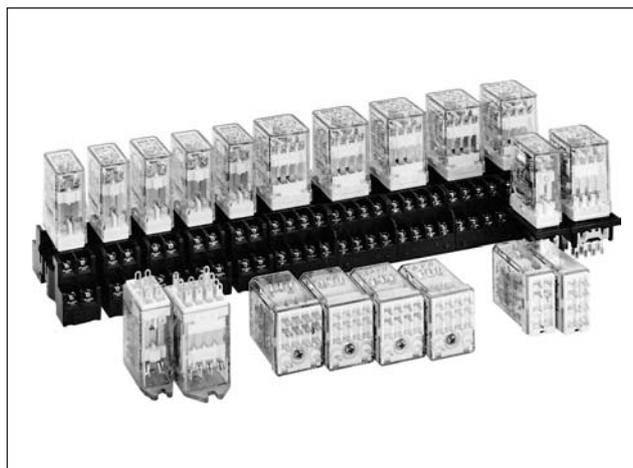

Types

• Plug-in Terminal Type

Contact	Type	DPDT		4PDT	
		Type No.	Coil Voltage Code *	Type No.	Coil Voltage Code *
Standard	Basic	RY2S-U* ★	AC6, AC12, AC24, AC50, AC100, AC110, AC115, AC120, AC200, AC220, AC230, AC240	RY4S-U* ★	AC6, AC12, AC24, AC50, AC100-110, AC110-120, AC200-220, AC220-240
	With Indicator	RY2S-UL* ★		RY4S-UL* ★	
	With Check Button	—		RY4S-UC* ★	
	With Indicator and Check Button	—		RY4S-ULC* ★	
	Top Bracket Mounting	RY2S-UT* ★	DC6, DC12, D24, DC48, DC100, DC110	RY4S-UT* ★	DC6, DC12, DC24, DC48, DC100-110
	With Diode (DC coil only)	RY2S-UD* ★	DC6, DC12, DC24, DC48, DC100, DC110	RY4S-UD* ★	DC6, DC12, DC24, DC48, DC100-110
	With Indicator and Diode (DC coil only)	—	—	RY4S-ULD* ★	
Bifurcated	Basic	RY22S-U* ★	AC6, AC12, AC24, AC50, AC100, AC110, AC115, AC120, AC200, AC220, AC230, AC240	—	—
	With Indicator	RY22S-UL* ★		—	
	Top Bracket Mounting	RY22S-UT* ★	DC6, DC12, DC24, DC48, DC100, DC110	—	
	With Diode (DC coil only)	RY22S-UD* ★	DC6, DC12, DC24, DC48, DC100, DC110	—	

• PC Board Terminal Type

Contact	Type	DPDT		4PDT	
		Type No.	Coil Voltage Code *	Type No.	Coil Voltage Code *
Standard	Standard	RY2V-U* ★	AC6, AC12, AC24, AC50, AC100, AC110, AC115, AC120, AC200, AC220, AC230, AC240	RY4V-U* ★	AC6, AC12, AC24, AC50, AC100-110, AC110-120, AC200-220, AC220-240
	With Indicator	RY2V-UL* ★		RY4V-UL* ★	
	With Diode (DC coil only)	RY2V-UD* ★	DC6, DC12, DC24, DC48, DC100, DC110	—	—
Bifurcated	Standard	RY22V-U* ★	AC6, AC12, AC24, AC50, AC100, AC110, AC115, AC120, AC200, AC220, AC230, AC240	—	—
	With Indicator	RY22V-UL* ★		—	
	With Diode (DC coil only)	RY22V-UD* ★	DC6, DC12, DC24, DC48, DC100, DC110	—	

Type numbers marked with ★ in the tables above are UL-recognized, CSA-certified, and TÜV-approved.

Ordering Information

When ordering, specify the Type No. and coil voltage code.

(Example) **RY4S-U** **AC100-110**
 Type No. Coil Voltage Code

RY Series Miniature Relays

Coil Ratings

	Rated Voltage (V)		Rated Current (mA) ±15% at 20°C				Coil Resistance (Ω) ±10% at 20°C		Operation Characteristics (against rated values at 20°C)		
	DPDT	4PDT	50Hz		60Hz		DPDT	4PDT	Max. Continuous Applied Voltage	Min. Pickup Voltage	Dropout Voltage
AC (50/60Hz)	6	6	170	240	150	200	18.8	9.4	110%	80% maximum	30% minimum
	12	12	86	121	75	100	76.8	39.3			
	24	24	42	60.5	37	50	300	153			
	50	50	20.5	28.9	18	24	1,280	680			
	100	100-110	10.5	10.3-11.8	9	9.1-10.0	5,220	3,360			
	110	—	9.6	—	8.4	—	6,950	—			
	115	110-120	8.9	9.4-10.8	7.8	8.0-9.2	7,210	4,290			
	120	—	8.6	—	7.5	—	8,100	—			
	200	200-220	5.6	5.1-5.9	4.9	4.3-5.0	21,442	13,690			
	220	—	4.7	—	4.1	—	25,892	—			
	230	220-240	4.7	4.7-5.4	4.1	4.0-4.6	26,710	18,820			
240	—	4.9	—	4.3	—	26,710	—				
DC	DPDT	4PDT	DPDT		4PDT		DPDT	4PDT	110%	80% maximum	10% minimum
	6	6	128		150		47	40			
	12	12	64		75		188	160			
	24	24	32		36.9		750	650			
	48	48	18		18.5		2,660	2,600			
	100	100-110	10		8.2-9.0		10,000	12,250			
	110	—	8		—		13,800	—			

Contact Ratings

Maximum Contact Capacity						
Contact	Continuous Current	Allowable Contact Power		Rated Load		
		Resistive Load	Inductive Load	Voltage	Resistive Load	Inductive Load
Standard Contact DPDT	3A	660 VA AC 90W DC	176 VA AC 45W DC	110V AC	3A	1.5A
				220V AC	3A	0.8A
				30V DC	3A	1.5A
Standard Contact 4PDT	5A	1200 VA AC 150W DC	288 VA AC 60W DC	240V AC	5A	1.2A
				30V DC	5A	2A
Bifurcated Contact DPDT	1A	176 VA AC 30W DC	88 VA AC 15W DC	110V AC	1A	0.5A
				220V AC	0.8A	0.4A
				30V DC	1A	0.5A

Note: Inductive load for the rated load — $\cos \phi = 0.3$, $L/R = 7$ ms

• UL Ratings (Standard Contact)

Voltage	Resistive		General use	
	DPDT	4PDT	DPDT	4PDT
240V AC	3A	5A	0.8A	5A
120V AC	—	—	1.5A	—
100V DC	0.2A	0.2A	0.2A	0.2A
30V DC	3A	5A	3A	5A

• CSA Ratings (Standard Contact)

Voltage	Resistive		General use	
	DPDT	4PDT	DPDT	4PDT
240V AC	3A	5A	0.8A	5A
120V AC	3A	—	1.5A	—
100V DC	—	—	0.2A	0.2A
30V DC	3A	5A	1.5A	1.5A

• TÜV Ratings (Standard Contact)

Voltage	DPDT	4PDT
240V AC	3A	5A
30V DC	3A	5A

AC: $\cos \phi = 1.0$, DC: $L/R = 0$ msec

• UL Ratings (Bifurcated Contact)

Voltage	Resistive	General use
240V AC	0.8A	0.4A
120V AC	1A	0.5A
30V DC	1A	0.5A

• CSA Ratings (Bifurcated Contact)

Voltage	Resistive	General use
240V AC	0.8A	0.4A
120V AC	1A	0.5A
30V DC	1A	—

RY Series Miniature Relays

Specifications

Contact Type	Standard Contact		Bifurcated Contact
	DPDT	4PDT	DPDT
Contact Material	Gold-plated silver		Silver-palladium alloy
Contact Resistance *1	50 mΩ maximum		100 mΩ minimum
Minimum Applicable Load	24V DC, 5 mA; 5V DC, 10 mA (reference value)		1V DC, 100 μA (reference value)
Operate Time *2	20 ms maximum		
Release Time *2	20 ms maximum		
Power Consumption (approx.)	AC: 1.1 VA (50 Hz), 1 VA (60 Hz) DC: 0.8W	AC: 1.4 VA (50 Hz), 1.2 VA (60 Hz) DC: 0.9W	AC: 1.1 VA (50 Hz), 1 VA (60 Hz) DC: 0.8W
Insulation Resistance	100 MΩ minimum (500V DC megger)		
Dielectric Strength	Between live and dead parts: 1500V AC, 1 minute *3 Between contact and coil: 1500V AC, 1 minute Between contacts of different poles: 1500V AC, 1 minute Between contacts of the same pole: 1000V AC, 1 minute	Between live and dead parts: 2000V AC, 1 minute Between contact and coil: 2000V AC, 1 minute Between contacts of different poles: 2000V AC, 1 minute Between contacts of the same pole: 1000V AC, 1 minute	Between live and dead parts: 1500V AC, 1 minute *3 Between contact and coil: 1500V AC, 1 minute Between contacts of different poles: 1500V AC, 1 minute Between contacts of the same pole: 1000V AC, 1 minute
Operating Frequency	Electrical: 1800 operations/h maximum Mechanical: 18,000 operations/h maximum		
Vibration Resistance	Damage limits: 10 to 55 Hz, amplitude 0.5 mm Operating extremes: 10 to 55 Hz, amplitude 0.5 mm		
Shock Resistance	Damage limits: 1000 m/s ² Operating extremes: 100 m/s ² (DPDT), 200 m/s ² (4PDT)		
Electrical Life	200,000 operations (220V AC, 3A)	100,000 operations (220V AC, 5A) 200,000 operations (220V AC, 3A)	200,000 operations (110V AC, 1A)
Mechanical Life	50,000,000 operations		
Operating Temperature *4	-25 to +55°C (no freezing)	-25 to +55°C (no freezing) *5	-25 to +55°C (no freezing)
Operating Humidity	45 to 85% RH (no condensation)		
Weight (approx.)	23g	34g	23g

Note: Above values are initial values.

*1: Measured using 5V DC, 1A voltage drop method

*2: Measured at the rated voltage (at 20°C), excluding contact bouncing
Release time of relays with diode: 40 ms maximum

*3: Relays with indicator or diode: 1000V AC, 1 minute

*4: For use under different temperature conditions, refer to Continuous Load Current vs. Operating Temperature Curve.
The operating temperature range of relays with indicator or diode is -25 to +40°C.

*5: When the total current of 4 contacts is less than 15A, the operating temperature range is -25 to +70°C.

Characteristics (Reference Data)

• Maximum Switching Capacity

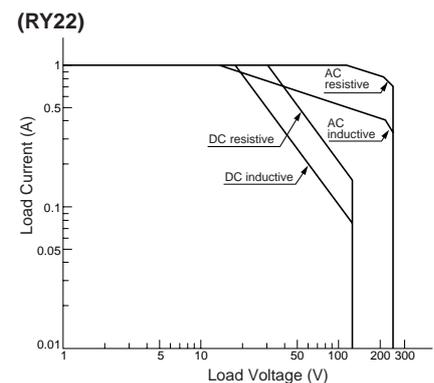
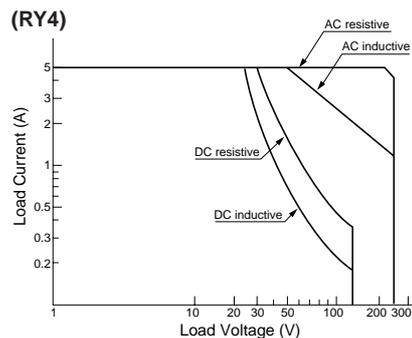
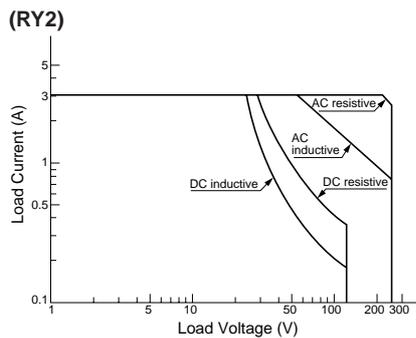

• Continuous Load Current vs. Operating Temperature Curve (Basic Type, With Check Button, and Top Bracket Mounting Type)

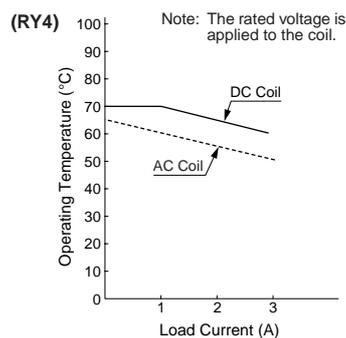
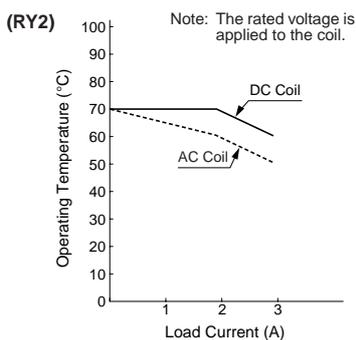

RY Series Miniature Relays

• Electrical Life Curve

AC Load
(RY2)

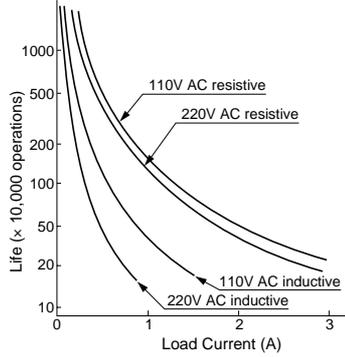

(RY4)

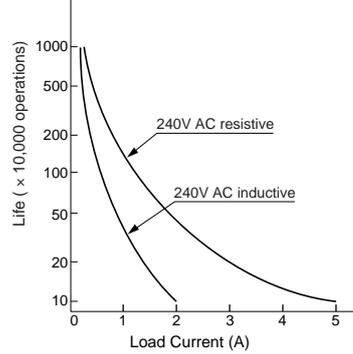

(RY22)

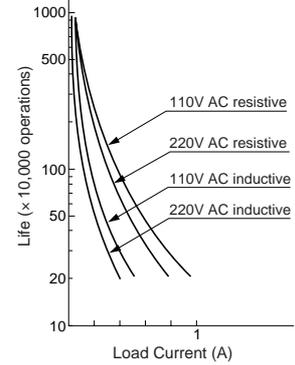

DC Load
(RY2)

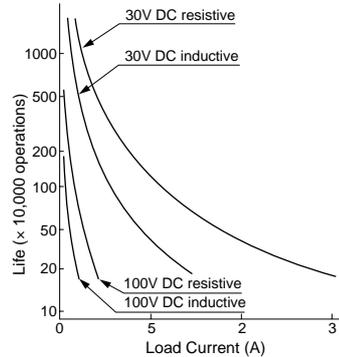

(RY4)

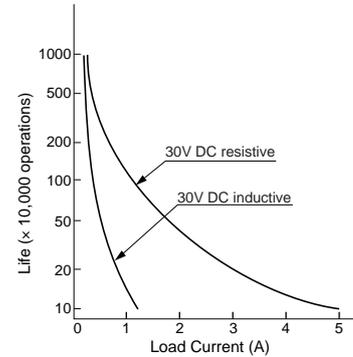

(RY22)

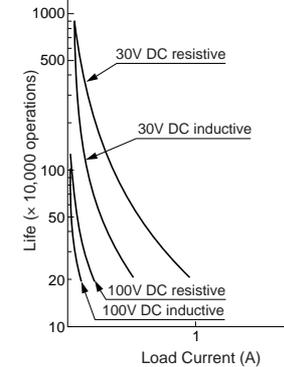

Internal Connection (Bottom View)

• Basic Type

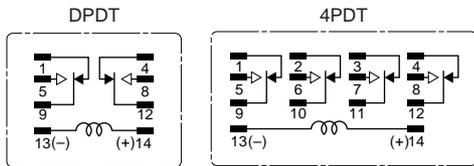

• With Check Button

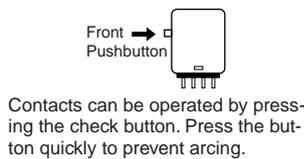

• With Indicator and Diode (-LD type)

This type contains an operation indicator and a surge absorber, and has the same height as the basic type.

• With Indicator (-L type)

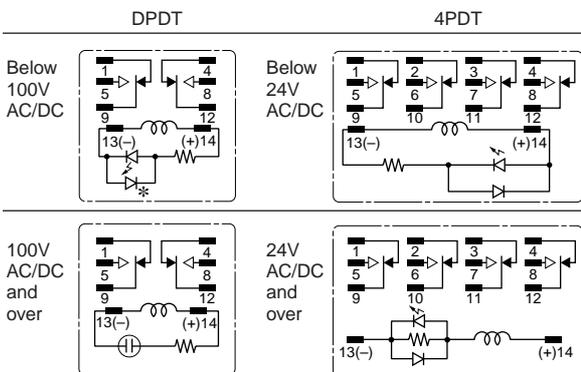

When the relay is energized, the indicator goes on.
* The LED protection diode is not contained in DPDT relays for below 100V DC.

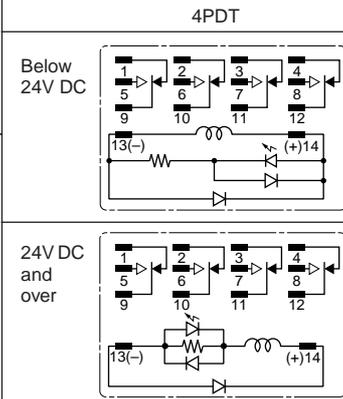

• With Diode (-D type)

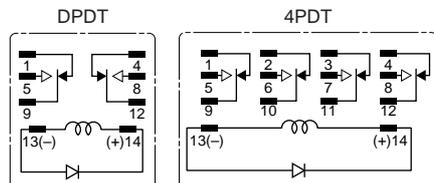

This type contains a diode to absorb the counter emf generated when the coil is deenergized. The release time is slightly longer.

- Diode Characteristics
Reverse withstand voltage: 1,000V
Forward current: 1A

RY Series Miniature Relays

Dimensions

• Plug-in Terminal Type

RY2S-U/RYS2S-UL
RY2S-UD



(Photo: RY2S-U)

RY22S-U/RYS22S-UL
RY22S-UD



(Photo: RY22S-U)

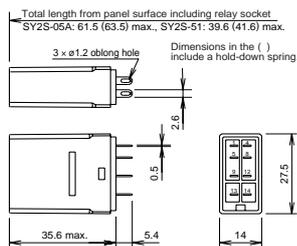

• Applicable Socket and Hold-down Spring

Socket		Hold-down Spring
Mounting Style	Type No.	
DIN Rail Mount Socket	SY2S-05A	SY2S-02F1 SFA-101 SFA-202
	SY2S-05C	
Panel Mount Socket	SY2S-51	SY4S-51F1 SFA-301 SFA-302
PC Board Mount Socket	SY2S-61	

RY4S-U/RYS4S-UL/RYS4S-UD/RYS4S-ULD



(Photo: RY4S-U)

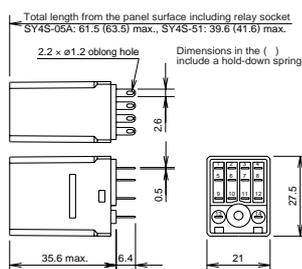

• Applicable Socket and Hold-down Spring

Socket		Hold-down Spring
Mounting Style	Type No.	
DIN Rail Mount Socket	SY4S-05A	SY4S-02F1 SFA-101 SFA-202
	SY4S-05C	
	SY4S-05D	
Panel Mount Socket	SY4S-51	SY4S-51F1 (SY4S-02F1) SFA-301 SFA-302
PC Board Mount Socket	SY4S-61	SY4S-51F1 (SY4S-02F1)
	SY4S-62	

Note: (SY4S-02F1) is for the relay with check button.

• PC Board Terminal Type

RY2V-U/RYS2V-UL/RYS2V-UD



(Photo: RY2V-U)



RY22V-U/RYS22V-UL/RYS22V-UD



(Photo: RY22V-U)

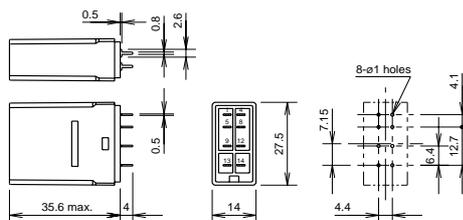

RY4V-U/RYS4V-UL



(Photo: RY4V-U)

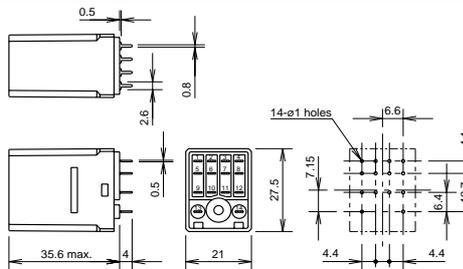

• Top Bracket Mounting Type (Plug-in Terminal)

RY2S-UT



RY22S-UT

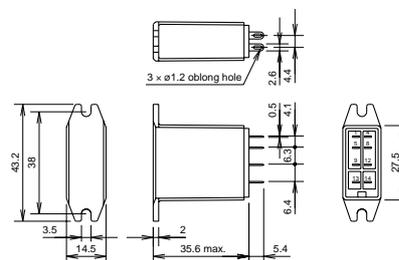

RY4S-UT

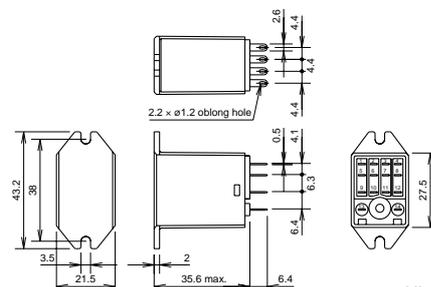

All dimensions in mm.

RR2KP Series Latch Relays

Self-maintained Latch Relays DPDT — 10A contact capacity

The RR2KP series latch relays have a self-holding function using permanent magnets in the magnetic circuit. Applying a voltage on the set (or reset) coil operates the armature and retains the contacts in that position until the opposite coil is energized, hence the latch relays are ideal for memory and flip-flop circuit applications.

- Enhanced self-holding functions, and vibration and shock resistance.
- The self-holding mechanism is not subject to wear unlike mechanical latch relays.
- Recognized by UL and certified by CSA.



Types

Terminal Style	Type	Type No.	Coil Voltage Code *
Pin Terminal	Basic	RR2KP-U*	AC6, AC12, AC24, AC50, AC100, AC110, AC115, AC120, AC200, AC220, AC230, AC240
	With Check Button	RR2KP-UC*	DC6, DC12, DC24, DC48, DC110

Ordering Information

When ordering, specify the Type No. and coil voltage code.

(Example) **RR2KP-U** **AC110**

Type No. Coil Voltage Code

Coil Ratings

Rated Voltage (V)	Rated Current (mA) ±15% at 20°C		Coil Resistance (Ω) ±10% at 20°C	Operation Characteristics (against rated values at 20°C)	
	50Hz	60Hz		Maximum Continuous Applied Voltage	Set and Reset Voltage
AC (50/60Hz)	6	467	429	110%	80% maximum
	12	200	184		
	24	100	92		
	50	48	44		
	100	24	22		
	110	23	21		
	115	23	21		
	120	24	22		
	200	12	11		
	220	10.9	10		
DC	6	240		110%	80% maximum
	12	120			
	24	60			
	48	30			
	110	13.8			

Contact Ratings

Switching Voltage	Continuous Current	Maximum Contact Capacity				
		Allowable Contact Power		Rated Load		
		Resistive Load	Inductive Load	Voltage	Res. Load	Ind. Load
250V AC 125V DC	10A	1650 VA AC 300W DC	1100 VA AC 225W DC	110V AC	10A	7.5A
				220V AC	7.5A	5A
				30V DC	10A	7.5A
				100V DC	0.5A	0.3A

Note: Inductive load for rated load — $\cos \phi = 0.3$, L/R = 7 ms

• UL Ratings

Voltage	Resistive	General Use	Motor Load
240V AC	10A	7A	1/3 HP
120V AC	10A	7.5A	1/4 HP
30V DC	10A	7A	—

• CSA Ratings

Voltage	Resistive	General Use	Motor Load
240V AC	10A	7A	1/3 HP
120V AC	10A	7.5A	1/4 HP
100V DC	—	0.5A	—
30V DC	10A	7.5A	—

RR2KP Series Latch Relays

Specifications

Contact Material	Silver
Contact Resistance	30 mΩ maximum (initial value)
Operate Time	25 ms maximum (at the rated voltage)
Power Consumption (approx.)	AC: 2.4 VA (50 Hz), 2.2 VA (60 Hz) DC: 1.5W
Insulation Resistance	100 MΩ minimum (500V DC megger)
Dielectric Strength	Between live and dead parts: 1,500V AC, 1 minute Between contact and coil: 1,500V AC, 1 minute Between contacts of different poles: 1,500V AC, 1 minute Between contacts of the same pole: 1,000V AC, 1 minute
Operating Frequency	Electrical: 1800 operations/h maximum Mechanical: 18,000 operations/h maximum
Temperature Rise	Coil: 85°C maximum, Contact: 65°C maximum
Vibration Resistance	0 to 60 m/s ² (maximum frequency: 55 Hz), Frequency: 5 to 55 Hz, Amplitude: 0.5 mm
Shock Resistance	100 m/s ² minimum
Electrical Life	500,000 operations minimum (110V AC, 10A)
Mechanical Life	5,000,000 operations minimum
Operating Temperature	-5 to +40°C (no freezing)
Operating Humidity	45 to 85% RH (no condensation)
Weight (approx.)	170g

Dimensions

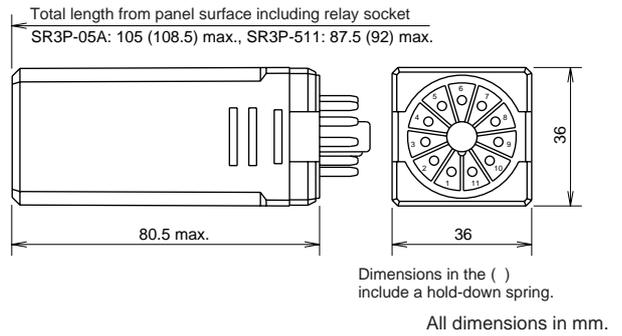

• Applicable Socket and Hold-down Spring

	Socket		Hold-down Spring
	Mounting Style	Type No.	
DIN Rail Mount Socket		SR3P-05A SR3P-05C SR3P-06A	SR3P-06F3
Panel Mount Socket	w/Solder Terminals	SR3P-511	SR3P-511F3
	w/Wire Wrap Terminals	SR3P-70	

Characteristics (Reference Data)

• Electrical Life Curve

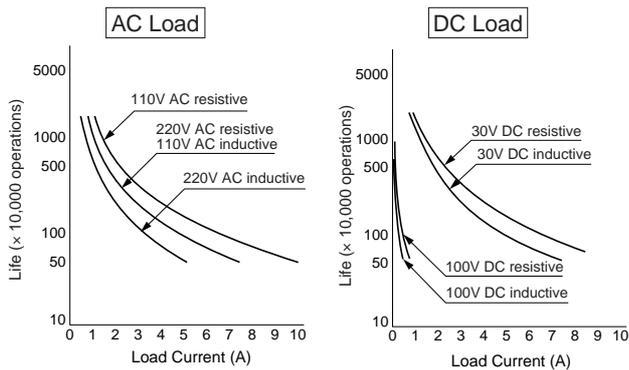

Internal Connection (Bottom View)

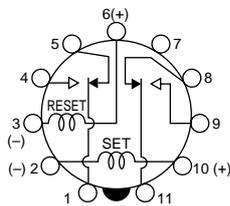

RH2L Series Latch Relays

Midget Power Latch Relays DPDT — 10A contact capacity

The RH2L series latch relays have a self-holding function by residual magnetism generated by a special magnetic material. The large 10A contact capacity equivalent to the RH and RR series is provided in a miniature relay package as small as the IDEC's RH3 type.

- With a mechanical operation indicator to show the set/reset status.
- Power saving operation by pulse inputs eliminates the need of continuous control voltage.
- Available with plug-in or PC board mount terminals.
- All basic types are recognized by UL and certified by CSA.



Types

Terminal Style	Type No.	Coil Voltage Code *
Plug-in Terminal	RH2LB-U*	AC6, AC12, AC24, AC50, AC100, AC120
PC Board Terminal	RH2LV2-U*	DC6, DC12, DC24

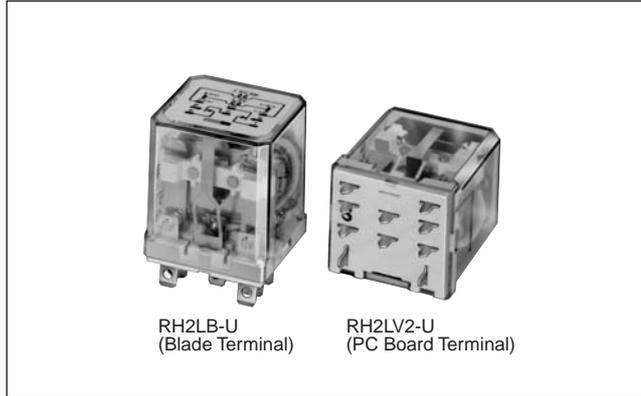

RH2LB-U (Blade Terminal) RH2LV2-U (PC Board Terminal)

Ordering Information

When ordering, specify the Type No. and coil voltage code.

(Example) **RH2LB-U** **AC120**
Type No. Coil Voltage Code

Coil Ratings

Rated Voltage (V)	Set Coil			Reset Coil			Operation Characteristics (against rated values at 20°C)	
	Rated Current (mA) ±15% at 20°C		Coil Resistance (Ω) ±10% at 20°C	Rated Current (mA) ±15% at 20°C		Coil Resistance (Ω) ±10% at 20°C	Maximum Continuous Applied Voltage	Set and Reset Voltage
	50Hz	60Hz		50Hz	60Hz			
AC (50/60Hz)	6	227	220	—	68.7	68	110%	80% maximum
	12	103	100	—	34.2	34		
	24	51.2	50	—	17.1	17		
	50	24.7	24	—	10.4	10.3		
	100	12.3	12	—	4.6	4.6		
	120	10.3	10	—	4.2	4.2		
DC	6	333		18	150		110%	80% maximum
	12	167		72	75			
	24	83		288	37.5			

Contact Ratings

Switching Voltage	Continuous Current	Maximum Contact Capacity				
		Allowable Contact Power		Rated Load		
		Resistive Load	Inductive Load	Voltage	Res. Load	Ind. Load
250V AC 125V DC	10A	1650 VA AC 300W DC	1100VA AC 225W DC	110V AC	10A	7.5A
				220V AC	7.5A	5A
				30V DC	10A	7.5A

Note: Inductive load for rated load — $\cos \phi = 0.3$, L/R = 7 ms

• UL Ratings

Voltage	Resistive	General Use	Motor Load
240V AC	7.5A	6.5A	1/3 HP
120V AC	10A	7.5A	1/6 HP
30V DC	10A	—	—

• CSA Ratings

Voltage	Resistive	General Use	Motor Load
240V AC	7.5A	5A	1/3 HP
120V AC	10A	7.5A	1/6 HP
30V DC	10A	7.5A	—

Specifications

Contact Material	Silver cadmium oxide
Contact Resistance	50 mΩ maximum (initial value)
Set Time	30 ms maximum (AC) 20 ms maximum (DC) (at the rated voltage)
Reset Time	30 ms maximum (AC) 20 ms maximum (DC) (at the rated voltage)
Power Consumption (approx.)	Set coil: 1.2 VA (AC), 2W (DC) Reset coil: 0.5 VA (AC), 0.9W (DC)
Insulation Resistance	100 MΩ minimum (500V DC megger)
Dielectric Strength	Between live and dead parts: 2,000V AC, 1 minute Between contact and coil: 2,000V AC, 1 minute Between contacts of different poles: 1,500V AC, 1 minute Between contacts of the same pole: 1,000V AC, 1 minute
Operating Frequency	Electrical: 1800 operations/h maximum Mechanical: 18,000 operations/h maximum
Vibration Resistance	0 to 60 m/s ² (maximum frequency: 55 Hz), Frequency: 5 to 55 Hz, Amplitude: 0.5 mm
Shock Resistance	100 m/s ² minimum
Electrical Life	200,000 operations minimum
Mechanical Life	10,000,000 operations minimum
Operating Temperature	-5 to +40°C (no freezing)
Weight (approx.)	50g

RH2L Series Latch Relays

Operation Indicator

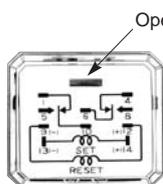

Operation Indicator

The red flag appears when the contacts are set.

Internal Connection (Bottom View)

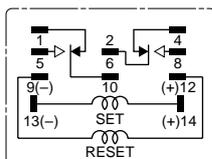

Instructions

1. Do not use the RH2L relays in environments where magnetic particles and dust are present in large quantities or external magnetic field is strong, or in the vicinity of large-current circuits.
2. Do not use the RH2L relays in circuits whose power source contains heavy surges.
3. When two or more RH2L relays are mounted in a row, separate the relays by 6 mm or more.
4. Do not energize the set and reset coils at the same time.
5. Because of the polarity of the coil, connect the DC input voltage to correct terminals of the DC coil type.

Dimensions

• RH2LB (Plug-in Terminal)

Total length from panel surface including relay socket
SH3B-05A: 61.5 (63.5) max., SH3B-51: 39.6 (41.6) max.

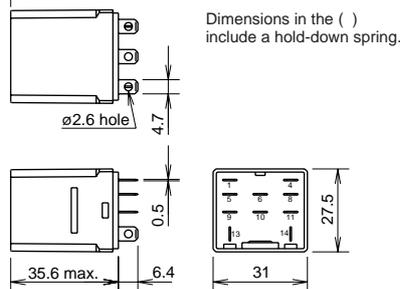

• RH2LV2 (PC Board Terminal)

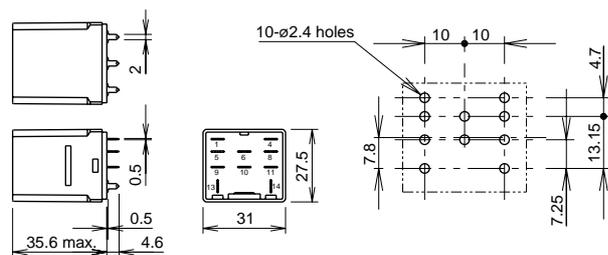

All dimensions in mm.

• Applicable Socket and Hold-down Spring

Socket		Hold-down Spring
Mounting Style	Type No.	
DIN Rail Mount Socket	SH3B-05A	SH3B-05F1 SFA-101 SFA-202
	SH3B-05C	
Panel Mount Socket	SH3B-51	SY4S-51F1 SFA-301 SFA-302
PC Board Mount Socket	SH3B-62	

For details about sockets and hold-down springs, see page 40.

RY2KS series Latch Relays

Self-maintained Latch Relays DPDT — 3A contact capacity

The RY2KS series latch relays have a self-holding function using permanent magnets in the magnetic circuit. Applying a voltage on the set (or reset) coil operates the armature and retains the contacts in that position until the opposite coil is energized, hence the latch relays are ideal for memory and flip-flop circuit applications.

- Mountable in the same space as other miniature relays using the same sockets.
- Recognized by UL and certified by CSA.

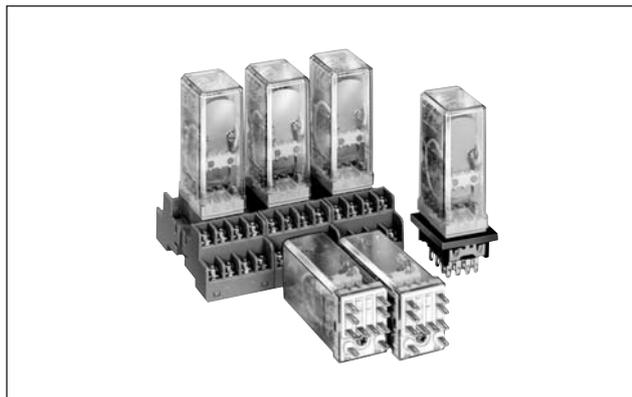

Types

Terminal Style	Type	Type No.	Coil Voltage Code *
Plug-in Terminal	Basic	RY2KS-U*	AC6, AC12, AC24, AC50, AC100, AC120
	With Check Button	RY2KS-UC*	DC6, DC12, DC24, DC48, DC100, DC110

Ordering Information

When ordering, specify the Type No. and coil voltage code.

(Example) **RY2KS-U** **AC120**
Type No. Coil Voltage Code

Coil Ratings

Rated Voltage (V)	Rated Current (mA) ±15% at 20°C		Coil Resistance (Ω) ±10% at 20°C	Operation Characteristics (against rated values at 20°C)	
	50Hz	60Hz		Maximum Continuous Applied Voltage	Set and Reset Voltage
AC (50/60Hz)	6	260	250	110%	80% maximum
	12	120	115		
	24	58	56		
	50	27	26		
	100	13.5	13		
	120	11.2	10.8		
DC	6	200	30	110%	80% maximum
	12	100	120		
	24	50	480		
	48	25	1,920		
	100	12	8,330		
	110	11	10,000		

Contact Ratings

Switching Voltage	Continuous Current	Maximum Contact Capacity				
		Allowable Contact Power		Rated Load		
		Resistive Load	Inductive Load	Voltage	Res. Load	Ind. Load
250V AC 125V DC	3A	660VA AC 90W DC	176VA AC 45W DC	110V AC	3A	1.5A
				220V AC	3A	0.8A
				30V DC	3A	1.5
				100V DC	0.2A	0.12A

Note: Inductive load for rated load — $\cos \phi = 0.3$, L/R = 7 ms

• UL Ratings

Voltage	Resistive	General Use
240V AC	3A	0.8A
120V AC	3A	1.5A
30V DC	3A	—

• CSA Ratings

Voltage	Resistive	General Use
240V AC	3A	0.8A
120V AC	3A	1.5A
100V DC	—	0.2A
30V DC	3A	1.5A

Specifications

Contact Material	Gold-plated silver
Contact Resistance	50 mΩ maximum (initial value)
Set Time	25 ms maximum (at the rated voltage)
Reset Time	25 ms maximum (at the rated voltage)
Power Consumption (approx.)	AC: 1.6 VA (50 Hz), 1.5 VA (60 Hz) DC: 1.2W
Insulation Resistance	100 MΩ minimum (500V DC megger)
Dielectric Strength	Between live and dead parts: 1,500V AC, 1 minute
	Between contact and coil: 1,000V AC, 1 minute
	Between contacts of different poles: 1,000V AC, 1 minute
	Between contacts of the same pole: 700V AC, 1 minute
Operating Frequency	Electrical: 1800 operations/h maximum Mechanical: 18,000 operations/h maximum
Temperature Rise	Coil: 85°C maximum, Contact: 65°C maximum
Vibration Resistance	0 to 60 m/s ² (maximum frequency: 55 Hz), Frequency: 5 to 55 Hz, Amplitude: 0.5 mm
Shock Resistance	200 m/s ² minimum
Electrical Life	200,000 operations minimum
Mechanical Life	5,000,000 operations minimum
Operating Temperature	-5 to +40°C (no freezing)
Weight (approx.)	67g

Characteristics (Reference Data)

• Electrical Life Curve

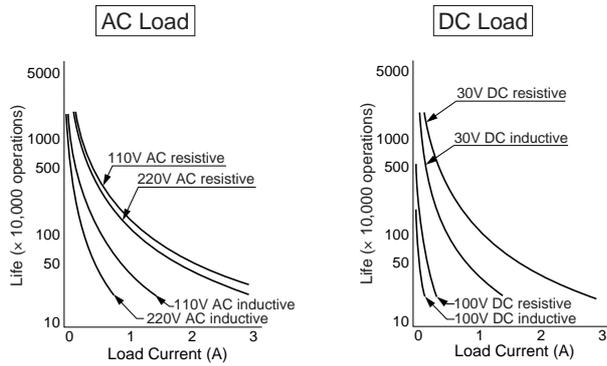

Internal Connection (Bottom View)

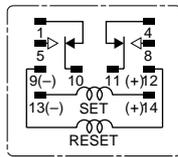

Dimensions

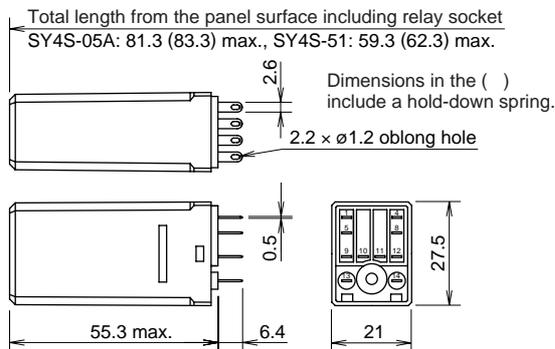

All dimensions in mm.

• Applicable Socket and Hold-down Spring

Socket		Hold-down Spring
Mounting Style	Type No.	
DIN Rail Mount Socket	SY4S-05A	SFA-202
	SY4S-05C	
Panel Mount Socket	SY4S-51	SY4S-51F3 (SY4S-02F3) SFA-302
PC Board Mount Socket	SY4S-61	
	SY4S-62	SY4S-51F3 (SY4S-02F3)

Notes:

1. For the relays with check button, use the parenthesized hold-down springs shown in the above table. When the spring is used, sockets cannot be mounted closely side by side.
2. Leaf springs come in pairs.
3. Use the hold-down springs in environments where the relays are subject to vibrations or shocks.

For details about sockets and hold-down springs, see page 40.

Relay Sockets

Socket Selection Guide

Mounting Style	Series	Type No.	Type	No. of Poles	Color	Terminal Screw Applicable Wire	Approvals	Rated Insulation Voltage/ Rated Current	Applicable Relay, etc.	Page						
DIN Rail Mount	SR	SR2P-05A	Standard	2	Black	M3.5 2 mm ² max.	—	250V, 10A	RR2P, GT3 (8-pin), GT5P	43						
		SR2P-05C	Finger-safe		Gray		UL, CSA, TÜV									
		SR2P-06A	Standard	3	Black		M3.5 2 mm ² max.				—	250V, 10A	RR3P, RR3PA, RR2KP, GT3 (11-pin)			
		SR3P-05A	Standard		Black						—					
		SR3P-05C	Finger-safe		Gray						UL, CSA, TÜV					
		SR3P-06A	Standard	Black	—											
	SR3B-05A	Standard	3	Black	—	RR1BA, RR2BA, RR3B										
	SH	SH1B-05A	Standard	1	Black	M3.5 (coil terminal: M3) 2 mm ² max.		—	250V, 10A (coil terminal: 7A)	RH1B						
		SH1B-05C	Finger-safe		Gray		UL, CSA, TÜV									
		SH2B-05A	Standard	2	Black		M3.5 2 mm ² max.	—			250V, 10A	RH2B				
		SH2B-05C	Finger-safe		Gray			UL, CSA, TÜV								
		SH2B-05D	Slim	3	Black			M3.5 2 mm ² max.				—	250V, 10A	RH3B, RH2LB		
		SH3B-05A	Standard		Black							—				
		SH3B-05C	Finger-safe		Gray							UL, CSA, TÜV				
		SH4B-05A	Standard	4	Black							M3.5 2 mm ² max.		—	250V, 10A	RH4B
		SH4B-05C	Finger-safe		Gray									UL, CSA, TÜV		
		SM	SM2S-05A	Standard	2									Black		M3 2 mm ² max.
	SM2S-05C		Finger-safe	Gray		UL, CSA, TÜV			250V, 7A (UL, TÜV: 10A)							
	SM2S-05D		Slim	Black		—			250V, 10A							
	SY	SY2S-05A	Standard	2	Black	M3 2 mm ² max.	—		250V, 7A	RY2S, RY22S						
		SY2S-05C	Finger-safe		Gray		UL, CSA, TÜV									
		SY4S-05A	Standard	4	Black		M3, 1.25 mm ² (2 mm ² max.)	—		250V, 6A	RY4S, RY2KS, RU4S, RU42S, GT5Y-U					
		SY4S-05C	Finger-safe		Gray			UL, CSA, TÜV								
		SY4S-05D	Slim		Black			—								
SU	SU2S-11L	Spring-clamp	2	Gray	Solid wire: 0.2 to 1.5 mm ² Stranded wire: 0.2 to 1.25 mm ²	UL, CSA, CE		250V, 10A	RU2S, RM2S, GT5Y-2							
	SU4S-11L	Spring-clamp	4					250V, 6A	RU4S, RU42S, RY4S, GT5Y-4							
Panel Mount	SR	SR2P-511	Solder	2	Black	—	UL, CSA	250V, 10A	RR2P, GT3 (8-pin), GT5P							
		SR2P-70	Wire-wrap			—				—						
		SR3P-511	Solder	3		—				UL, CSA	250V, 10A	RR3P, RR3PA, RR2KP, RR1BA, RR2BA, RR3B				
		SR3P-70	Wire-wrap			—							—			
		SR3B-51	Solder			—							UL, CSA			
	SH	SH1B-51	Solder	1		—	UL, CSA	250V, 10A (coil terminal: 7A)	RH1B							
		SH2B-51		2		—	UL, CSA	250V, 10A	RH2B							
		SH3B-51		3		—	UL, CSA		RH3B, RH2LB							
		SH4B-51		4		—	UL, CSA		RH4B							
	SM	SM2S-51	Solder	2		—	UL, CSA		250V, 10A	RM2S, RU2S, GT5Y-2						
		SY2S-51	Solder	2		—	UL, CSA	250V, 7A	RY2S, RY22S							
	SY	SY4S-51		4		—	UL, CSA	250V, 7A (Note)	RY4S, RY2KS, RU4S, RU42S, GT5Y-U							
		PC Board Mount	SH	SH1B-62		PC board	1	—	UL, CSA	250V, 10A (coil terminal: 7A)	RH1B					
	SH2B-62			2			—	UL, CSA	250V, 10A	RH2B						
SH3B-62	3			—	UL, CSA		RH3B, RH2LB									
SH4B-62	4			—	UL, CSA		RH4B									
SM	SM2S-61		PC board	2	—	UL, CSA	250V, 10A	RM2S, RU2S, GT5Y-2								
	SM2S-62				—	UL, CSA	250V, 10A	RM2S, RU2S								
SY	SY2S-61		PC board	2	—	UL, CSA	250V, 7A	RY2S, RY22S								
	SY4S-61			4	—	UL, CSA	250V, 7A (Note)	RY4S, RY2KS, RU4S, RU42S, GT5Y-U								
SY4S-62	—	UL, CSA	250V, 7A													

Note: When using only 2 poles of the 4-pole sockets SY4S-51 and SY4S-61, the UL rated current is 10A.

• Terminal Screw Tightening Torque for DIN Rail Mount Sockets

Socket Series	Terminal Screw Tightening Torque	Socket Series	Terminal Screw Tightening Torque
SR	1.0 to 1.3 N·m	SM	0.6 to 1.0 N·m
SH	1.0 to 1.3 N·m	SY	0.6 to 1.0 N·m

Relay Sockets

Sockets and Applicable Hold-down Springs

• DIN Rail Mount Sockets

Socket Type No.	Applicable Relays and Timers	Hold-down Spring	
		Wire Spring	Leaf Spring
SR2P-05A SR2P-05C	RR2P	SR2B-02F1	—
	GT5P	—	SFA-203
SR2P-06A	RR2P	SR2B-02F1	SFA-202
	GT3 (8-pin), GT5P	—	SFA-202
SR3P-05A SR3P-05C	RR3P, RR3PA	SR3B-02F1	—
	RR2KP	SR3P-06F3	—
	GT3 (11-pin)	—	SFA-203
SR3P-06A	RR3P, RR3PA	SR3B-02F1	SFA-202
	RR2KP	SR3P-06F3	—
	GT3 (11-pin)	—	SFA-202
SR3B-05	RR1BA, RR2BA, RR3B	SR3B-02F1	SFA-202
SH1B-05A SH1B-05C	RH1B	SY2S-02F1	SFA-101 SFA-202
		—	—
SH2B-05A SH2B-05C	RH2B	SY4S-02F1	SFA-101 SFA-202
		RH2B-R	—
SH2B-05D	RH2B	—	SFA-502
		RH2B-R	—
SH3B-05A SH3B-05C	RH3B, RH2LB	SH3B-05F1	SFA-101 SFA-202
		—	—
SH4B-05A SH4B-05C	RH4B	SH4B-02F1	SFA-101 SFA-202
		—	—
SM2S-05A SM2S-05C	RM2S, RU2S	SY4S-02F1	SFA-101 SFA-202
		GT5Y-2	—
SM2S-05D	RM2S, RU2S	—	SFA-502
		GT5Y-2	—
SY2S-05A SY2S-05C	RY2S, RY22S	SY2S-02F1	SFA-101 SFA-202
		—	—
SY4S-05A SY4S-05C	RY4S, RU4S, RU42S	SY4S-02F1	SFA-101 SFA-202
		RY2KS, GT5Y-4	—
SY4S-05D	RY4S, RU4S, RU42S	—	SFA-502
		RY2KS, GT5Y-4	—
SU2S-11L	RU2S, RM2S	—	SFA-101 SFA-202
		GT5Y-2	—
SU4S-11L	RU4S, RU42S, RY4S	—	SFA-101 SFA-202
		GT5Y-4	—

• Panel Mount Sockets and PC Board Mount Sockets

Socket Type No.	Applicable Relays and Timers	Hold-down Spring	
		Wire Spring	Leaf Spring
SR2P-511 SR2P-70	RR2P	SR3P-01F1	—
	GT3 (8-pin)	—	SFA-402
	GT5P	—	SFA-302
SR3P-511 SR3P-70	RR3P, RR3PA	SR3P-01F1	—
	RR2KP	SR3P-511F3	—
	GT3 (11-pin)	—	SFA-402
SR3B-51	RR1BA, RR2BA, RR3B	SR3B-02F1	—
SH1B-51 SH1B-62	RH1B	SY4S-51F1	SFA-301 SFA-302
		—	—
SH2B-51	RH2B	SY4S-51F1 (SY4S-02F1)	SFA-301 SFA-302
		RH2B-R	—
SH2B-62	RH2B	SY4S-51F1 (SY4S-02F1)	—
SH3B-51 SH3B-62	RH3B, RH2LB	SY4S-51F1 (SH3B-05F1)	SFA-301 SFA-302
		—	—
SH4B-51 SH4B-62	RH4B	SY4S-51F1 × 2 (SH4B-02F1)	SFA-301 SFA-302
		—	—
SM2S-51 SM2S-61	RM2S, RU2S	SY4S-51F1 (SY4S-02F1)	SFA-301 SFA-302
		GT5Y-2	—
SM2S-62	RM2S, RU2S	SY4S-51F1 (SY4S-02F1)	—
SY2S-51 SY2S-61	RY2S, RY22S	SY4S-51F1	SFA-301 SFA-302
		—	—
SY4S-51 SY4S-61	RY4S, RU4S, RU42S	SY4S-51F1 (SY4S-02F1)	SFA-301 SFA-302
		RY2KS	SY4S-51F3 (SY4S-02F3)
		GT5Y-4	—
SY4S-62	RY4S, RU4S, RU42S	SY4S-51F1 (SY4S-02F1)	—
		RY2KS	SY4S-51F3 (SY4S-02F3)

Note 1: When mounting relays with check button on panel mount or PC board mount sockets, use hold-down springs shown in (). Hold-down springs for relays with check button are not available for SR2P-511, SR2P-70, SR3P-511, and SR3P-70.

Note 2: For close mounting of panel mount or PC board mount sockets, use wire springs or SFA-302 leaf springs.

Note 3: SM2S-62 and SY4S-62 sockets cannot be used on GT5Y-2 and GY5Y-4 timers.

• Hold-down Springs

Type	Type No.	Ordering Type No.	Package Quantity
Wire Spring	SR2B-02F1	SR2B-02F1PN10	10
	SR3B-02F1	SR3B-02F1PN10	
	SR3P-01F1	SR3P-01F1PN10	
	SR3P-06F3	SR3P-06F3PN10	
	SR3P-511F3	SR3P-511F3PN10	
	SH3B-05F1	SH3B-05F1PN10	
	SH4B-02F1	SH4B-02F1PN10	
	SY2S-02F1	SY2S-02F1PN10	
	SY4S-02F1	SY4S-02F1PN10	
	SY4S-02F3	SY4S-02F3PN10	
Leaf Spring	SY4S-51F1	SY4S-51F1PN10	20 (10 pairs)
	SY4S-51F3	SY4S-51F3PN10	
	SFA-101	SFA-101PN20	
	SFA-202	SFA-202PN20	
	SFA-203	SFA-203PN20	
	SFA-301	SFA-301PN20	
	SFA-302	SFA-302PN20	
SFA-402	SFA-402PN20		
SFA-502	SFA-502PN20		
SFA-511	SFA-511PN20		

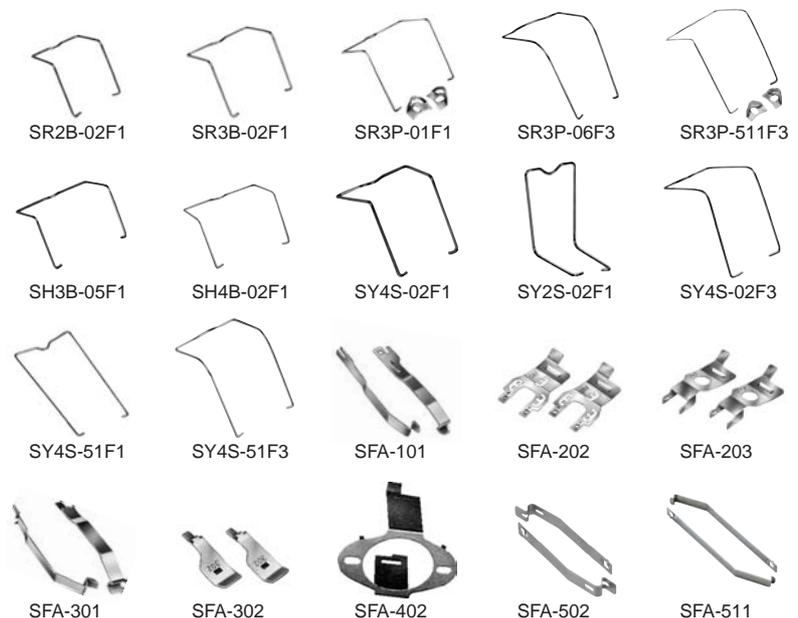

Relay Sockets

Accessories for Sockets

Name	Appearance	Specifications	Type No.	Ordering Type No.	Package Quantity	Remarks
DIN Rail		Aluminum Weight: Approx. 200g	BAA1000	BAA1000PN10	10	Length: 1m Width: 35 mm
		Steel Weight: Approx. 320g	BAP1000	BAP1000PN10	10	
Mounting Clip		Zinc-plated steel Weight: Approx. 15g	BNL5	BNL5PN10	10	Used on a DIN rail to fasten relay sockets
			BNL6	BNL6PN10	10	
DIN Rail Spacer		Plastic (black)	SA-406B	SA-406B	1	Thickness: 5 mm Used for adjusting spacing between sockets mounted on a DIN rail
End Spacer		Plastic (black)	SA-203B	SA-203B	1	Used for mounting DIN rail mount sockets directly on a panel surface
Intermediate Spacer			SA-204B	SA-204B	1	

• Accessories for SU Sockets

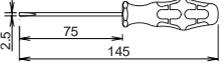
Name	Appearance	Specifications	Type No.	Ordering Type No.	Package Quantity	Remarks	
Screwdriver		Weight: Approx. 20g	BC1S-SD0	BC1S-SD0	1	Used for wiring spring-clamp terminals on the SU sockets	
Jumper		Brass jumper with ABS sheath Rated current: 3A Weight: Approx. 3g	SU9Z-J5	SU9Z-J5PN10	10	Used for interconnecting relay coil terminals on a maximum of five SU sockets; can be cut to required lengths	
Diode Module		6 to 220V DC	SU9Z-D11	SU9Z-D11PN10	10	A1: - A2: +	For absorbing surge voltages in DC coils
			SU9Z-D12	SU9Z-D12PN10	10	A1: + A2: -	
RC Module		6 to 240V AC	SU9Z-R21	SU9Z-R21PN10	10	For absorbing surge voltages in AC coils	
LED Module		6 to 12V AC/DC	SU9Z-L31	SU9Z-L31PN10	10	Non-polarized LED indicator; goes on when the relay coil is energized	
		24 to 48V AC/DC	SU9Z-L32	SU9Z-L32PN10	10		
		100 to 120V AC/DC	SU9Z-L33	SU9Z-L33PN10	10		
		200 to 240V AC/DC	SU9Z-L34	SU9Z-L34PN10	10		

Relay Sockets

DIN Rail Mount Sockets

SR Series

• SR2P-05A

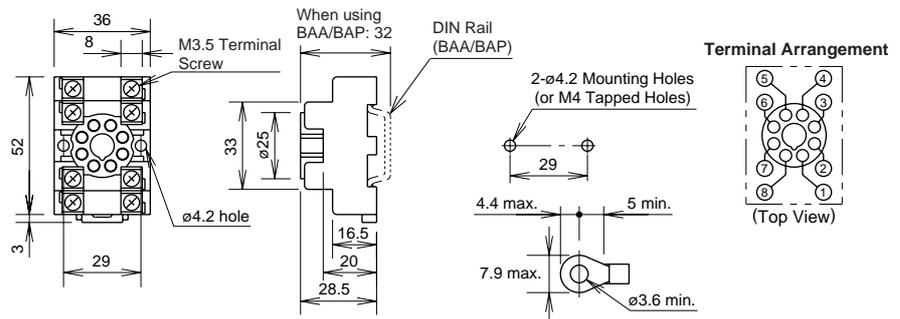

• SR2P-05C

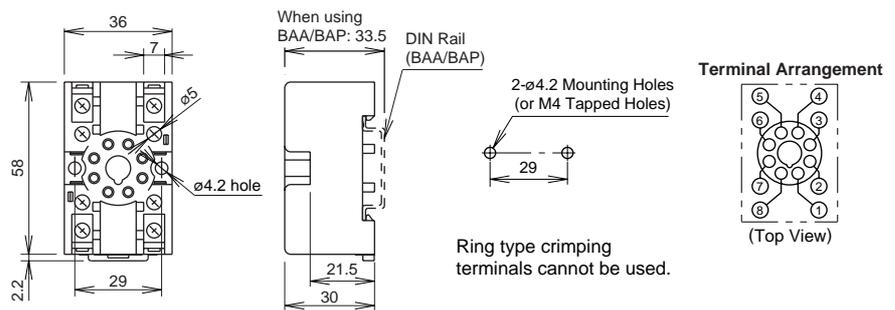

• SR2P-06A

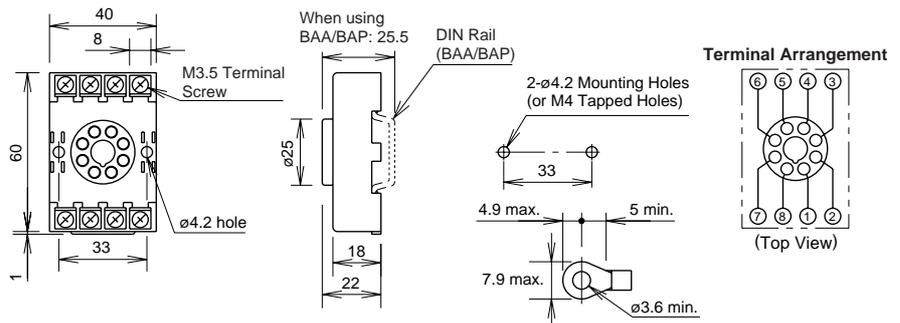

• SR3P-05A

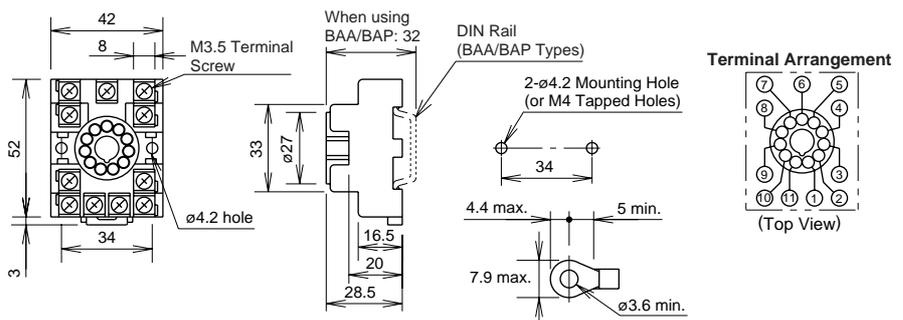

• SR3P-05C

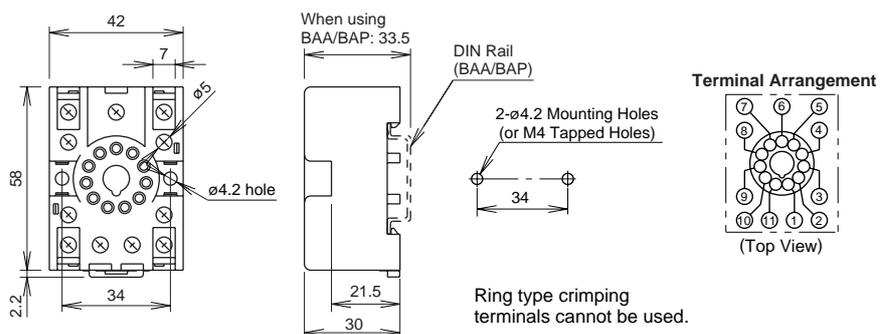

Relay Sockets

• SR3P-06A

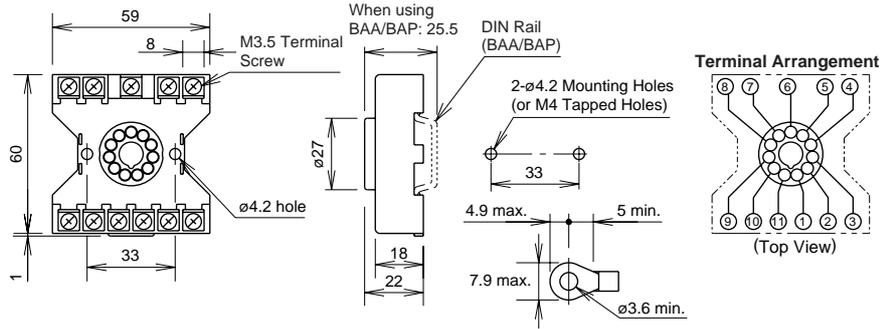

• SR3B-05

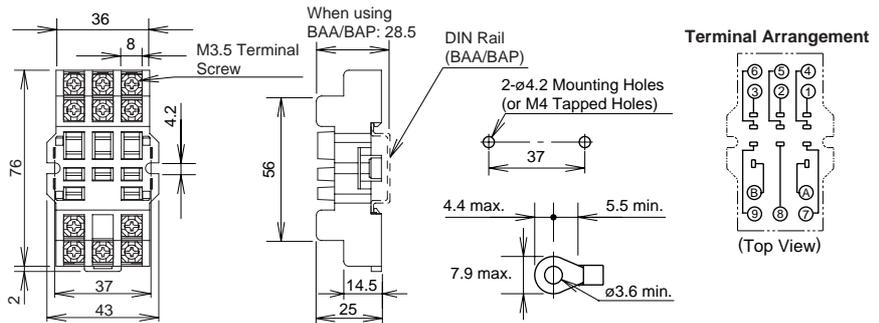
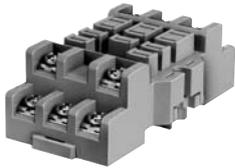

SH Series

• SH1B-05A

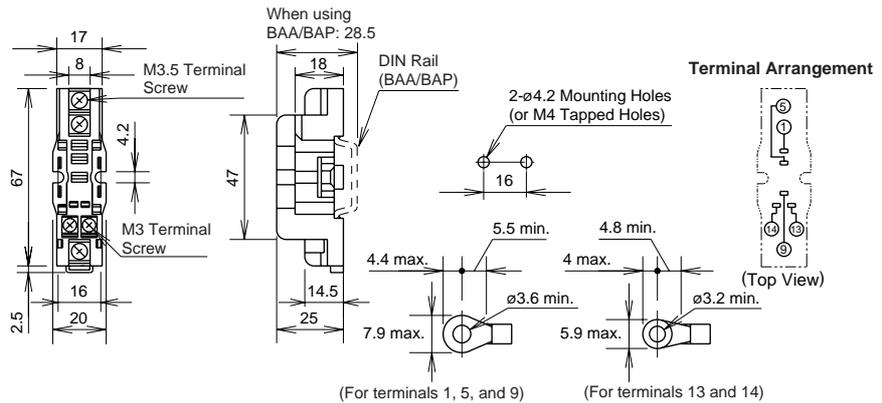

• SH1B-05C

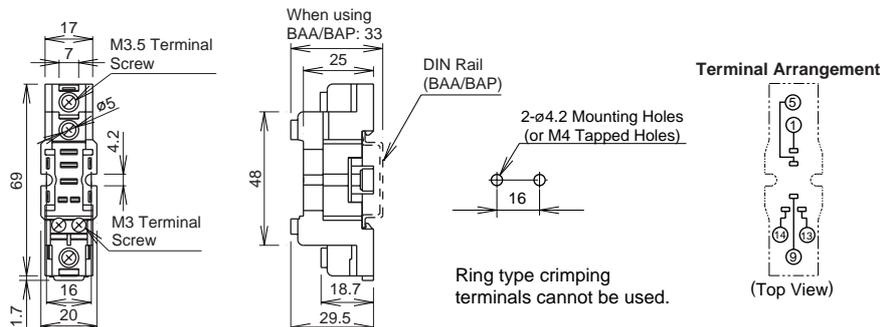
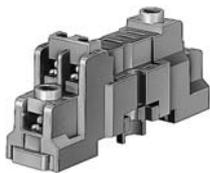

• SH2B-05A

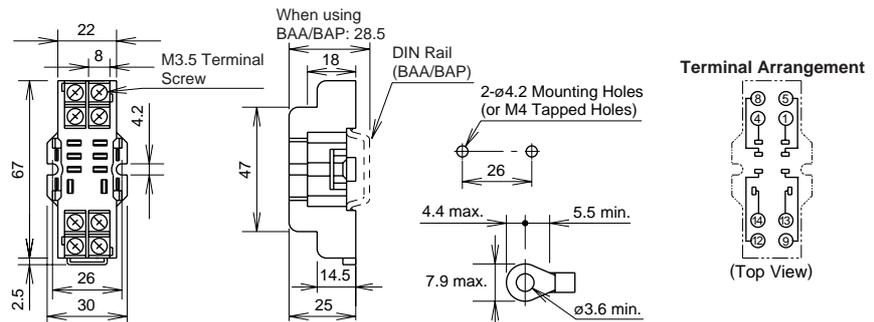

Relay Sockets

• SH2B-05C

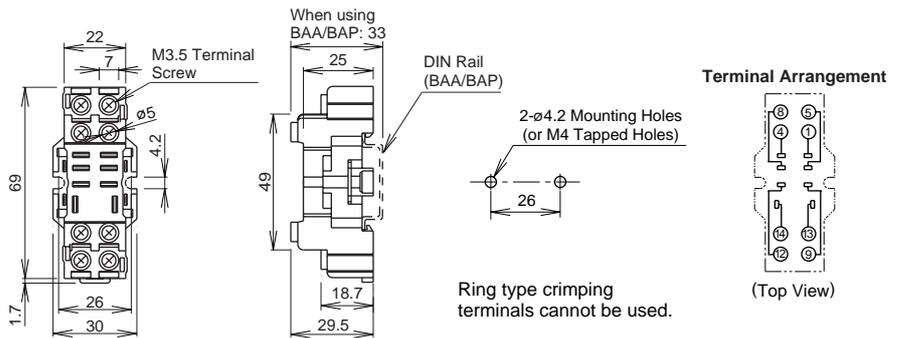

• SH2B-05D

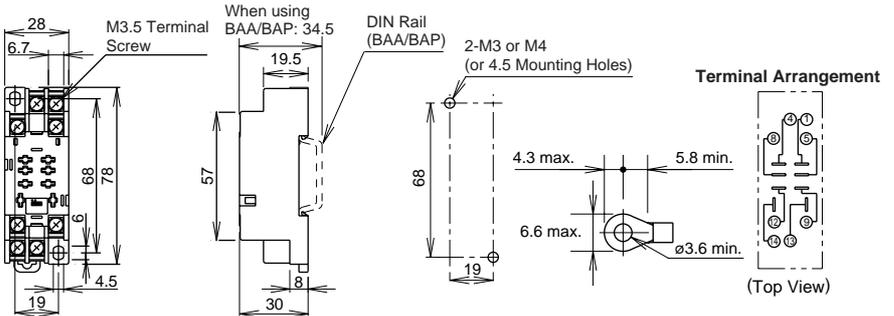

• SH3B-05A

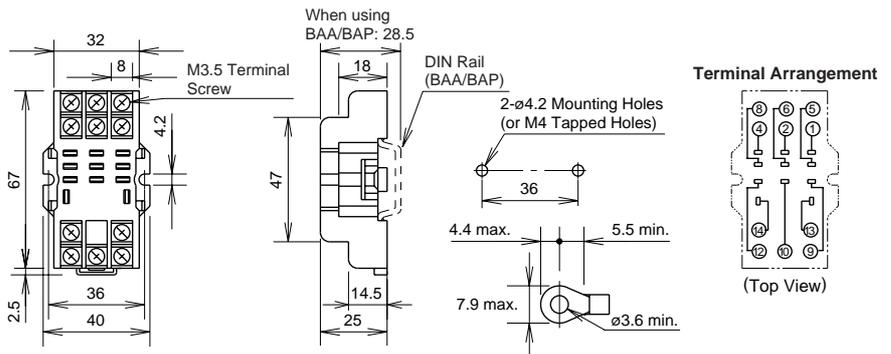

• SH3B-05C

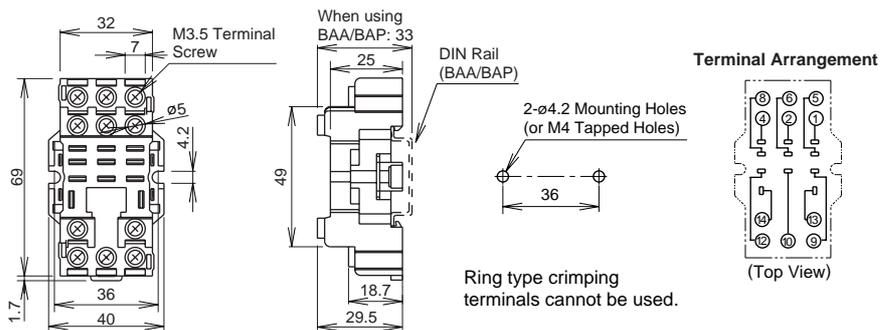

• SH4B-05A

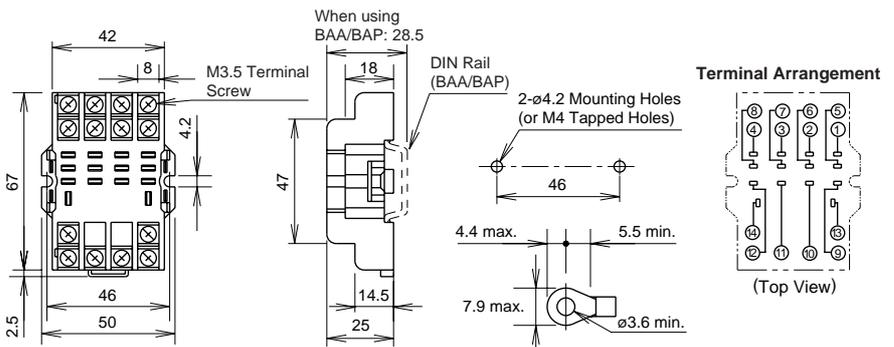

Relay Sockets

• SH4B-05C

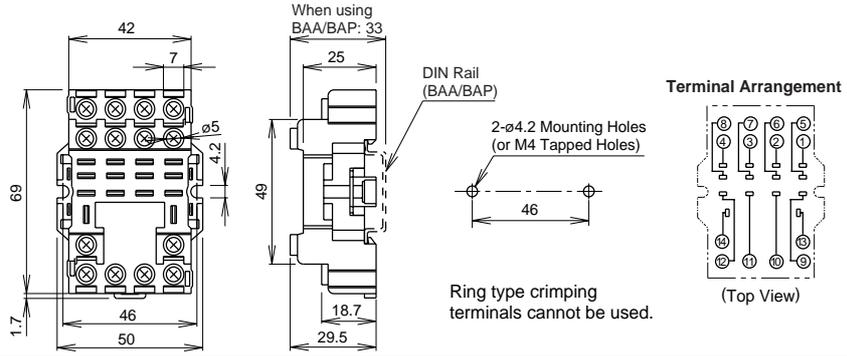

SM Series

• SM2S-05A

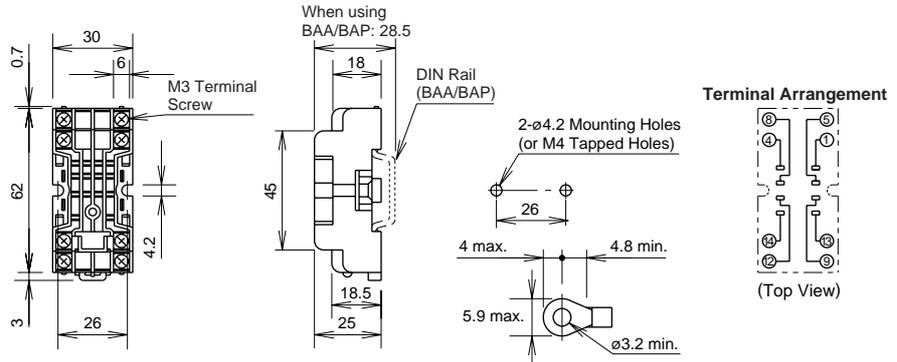

• SM2S-05C

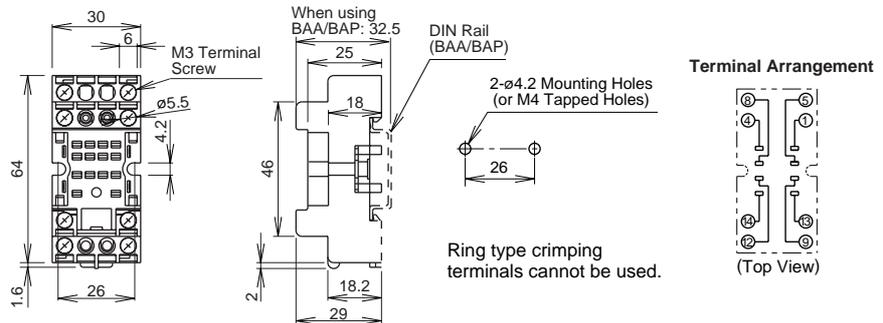
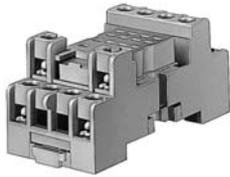

• SM2S-05D

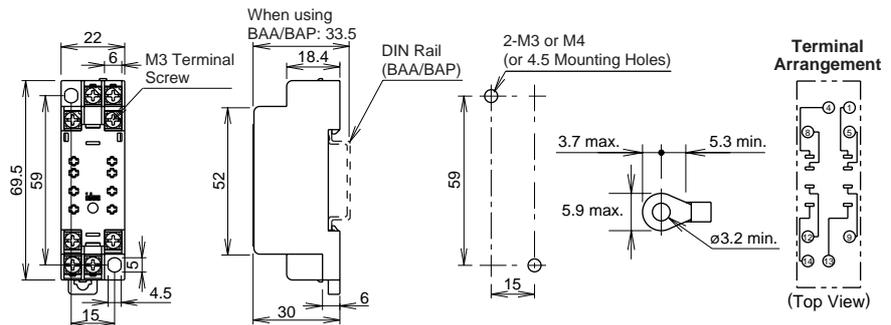

Relay Sockets

SY Series

• SY2S-05A

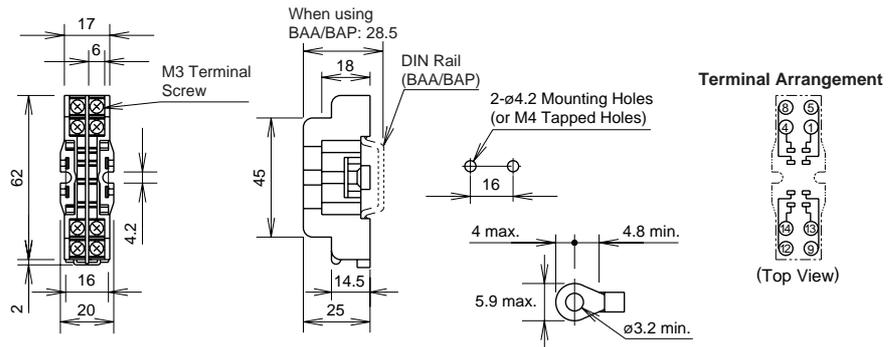

• SY2S-05C

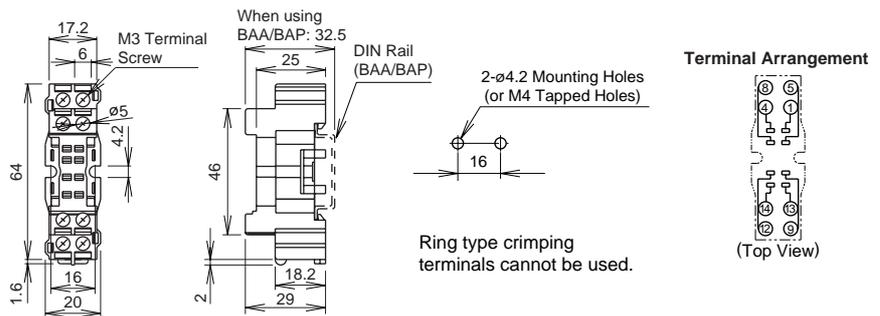
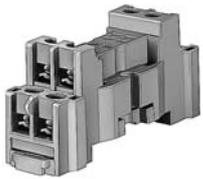

• SY4S-05A

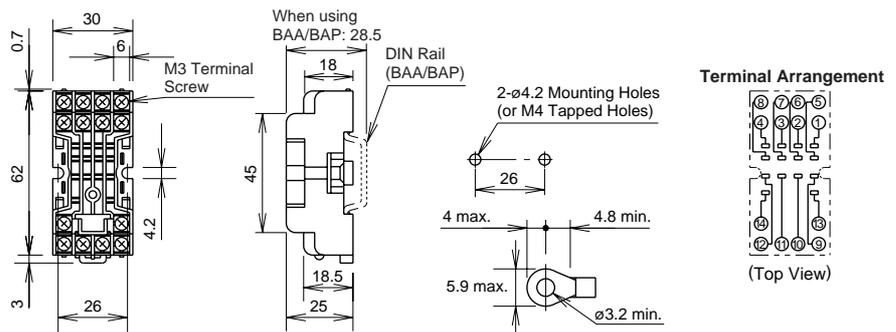

• SY4S-05C

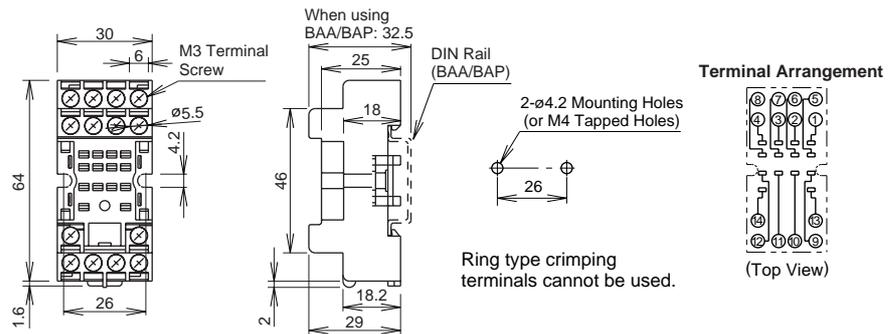

• SY4S-05D

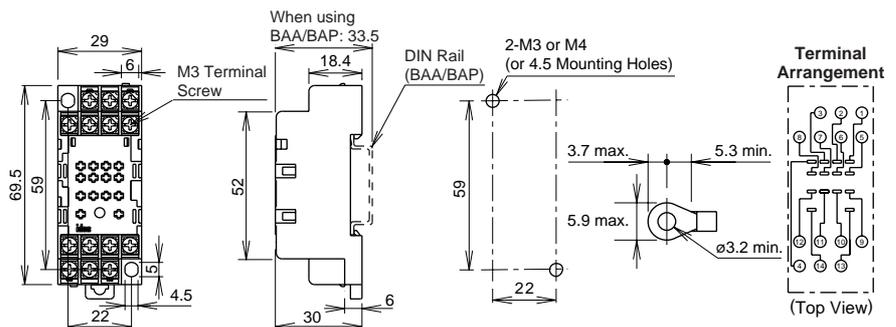

Relay Sockets

SU Series

• SU2S-11L

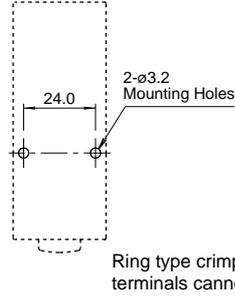
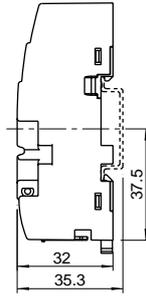
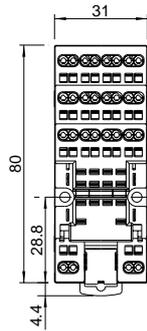

Terminal Arrangement

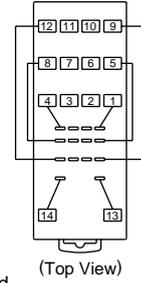

Ring type crimping terminals cannot be used.

• SU4S-11L

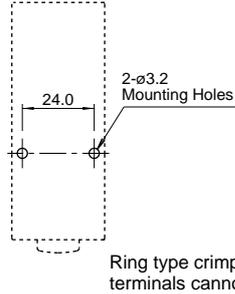
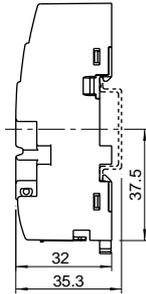
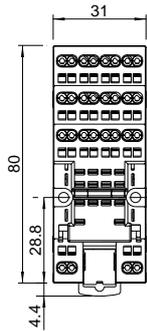

Terminal Arrangement

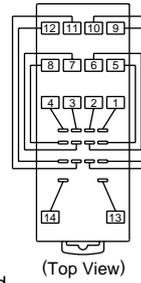

Ring type crimping terminals cannot be used.

Panel Mount Sockets

SR Series

• SR2P-511

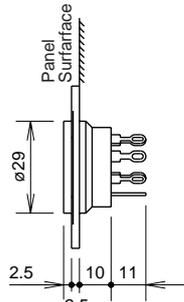
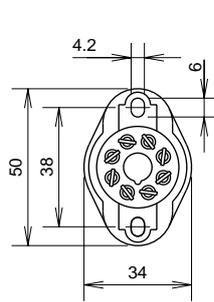

Terminal Arrangement

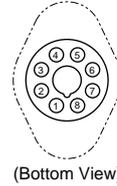

2- ϕ 3.5 Mounting Holes (or M3 Tapped Holes)

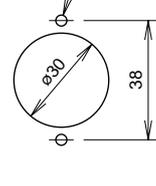

• SR2P-70

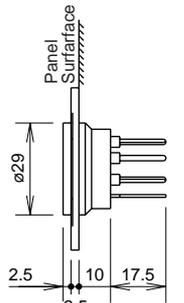
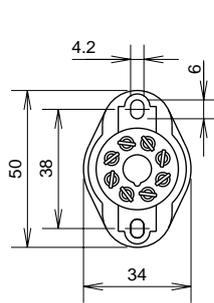

Terminal Arrangement

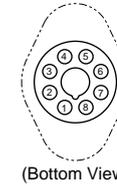

2- ϕ 3.5 Mounting Holes (or M3 Tapped Holes)

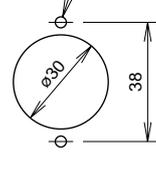

• SR3P-511

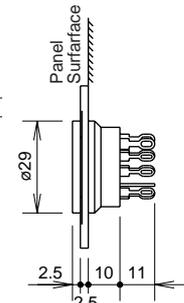
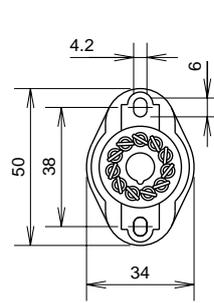

Terminal Arrangement

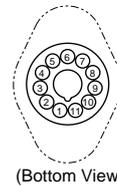

2- ϕ 3.5 Mounting Holes (or M3 Tapped Holes)

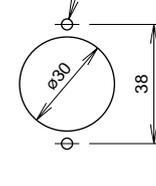

Relay Sockets

• SR3P-70

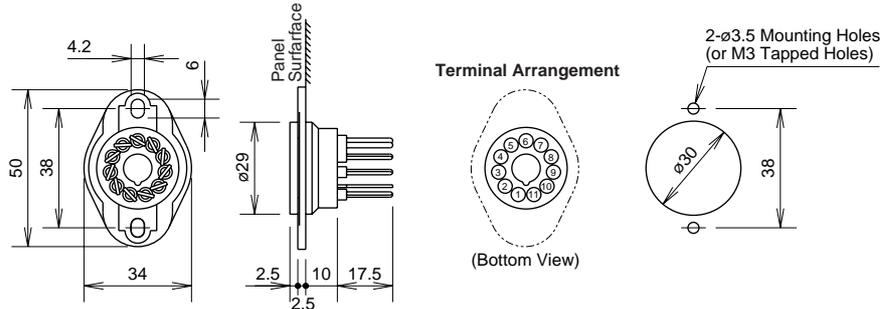

• SR3B-51

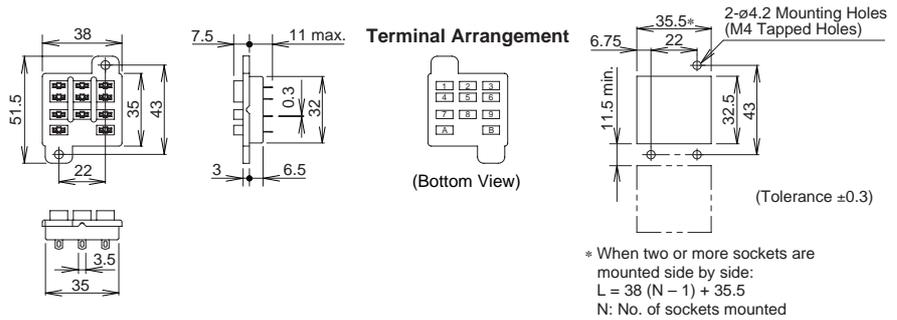

SH Series

• SH1B-51

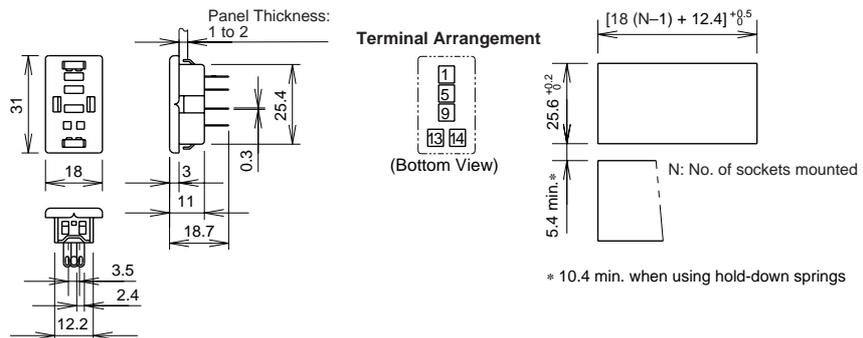
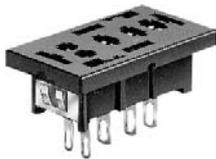

• SH2B-51

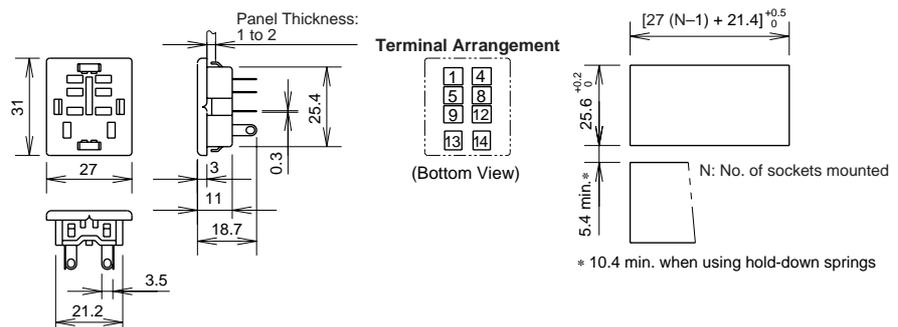

• SH3B-51

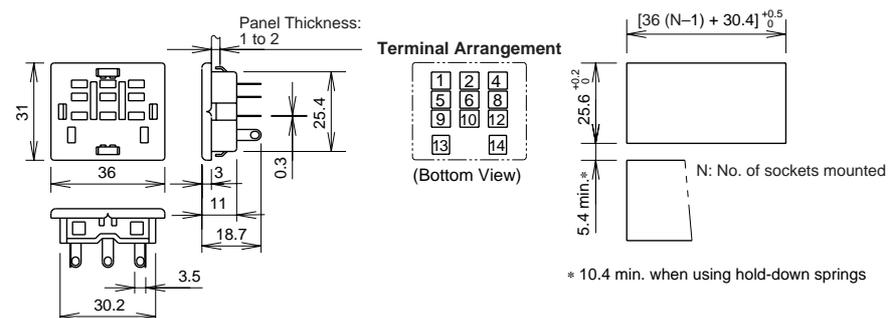
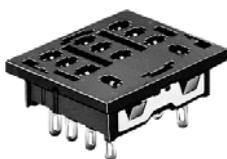

Relay Sockets

• SH4B-51

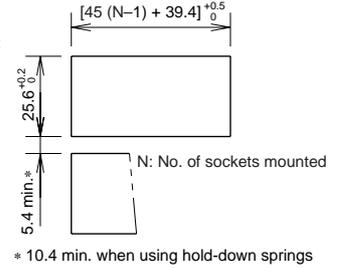
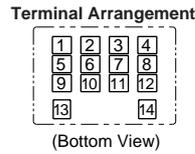
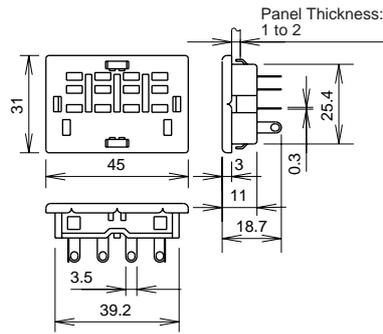

SM Series

• SM2S-51

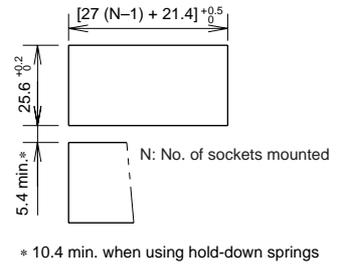
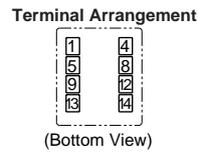
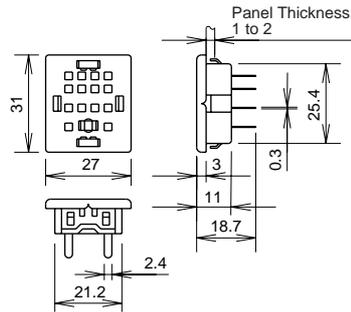

SY Series

• SY2S-51

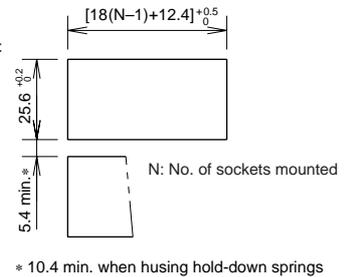
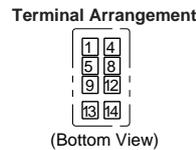
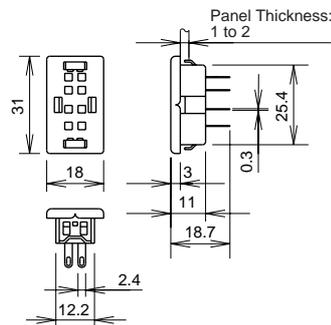

• SY4S-51

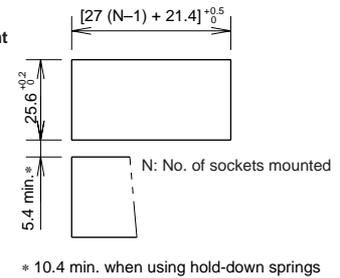
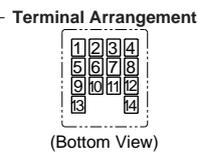
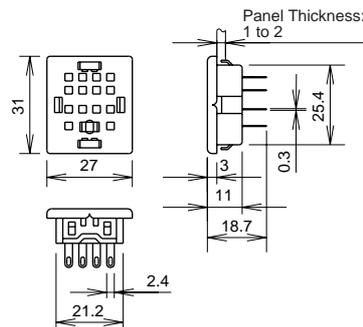

Relay Sockets

PC Board Mount Sockets

SH Series

• SH1B-62

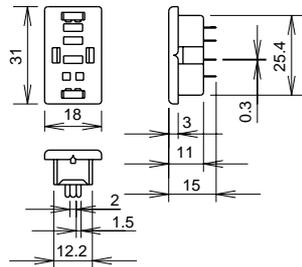

Terminal Arrangement

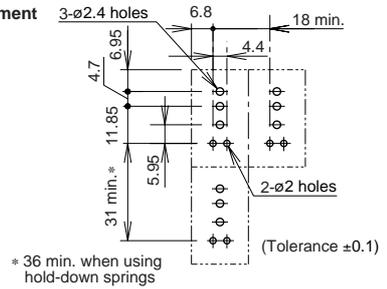
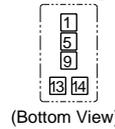

• SH2B-62

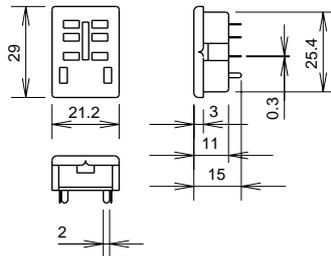

Terminal Arrangement

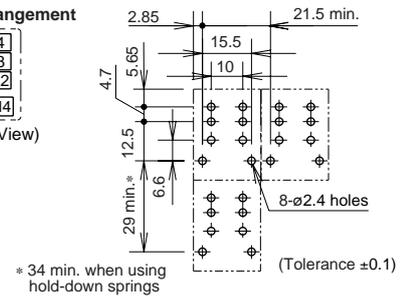
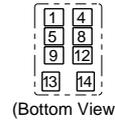

• SH3B-62

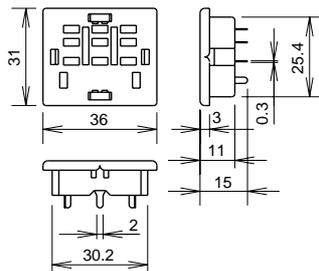

Terminal Arrangement

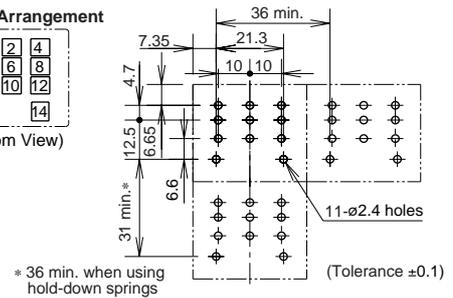
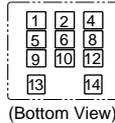

• SH4B-62

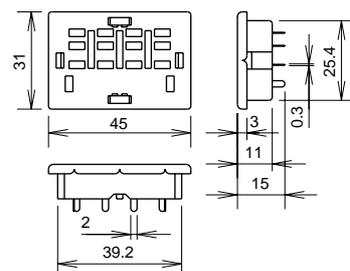

Terminal Arrangement

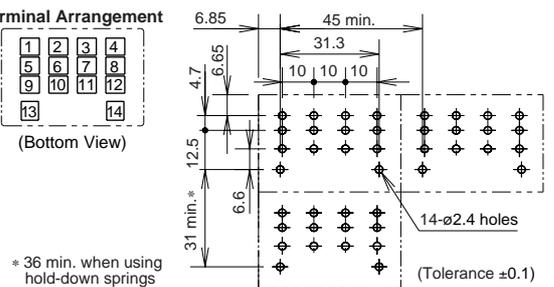
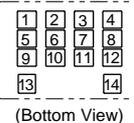

SM Series

• SM2S-61

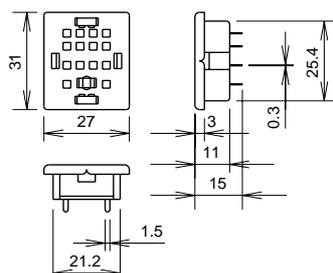

Terminal Arrangement

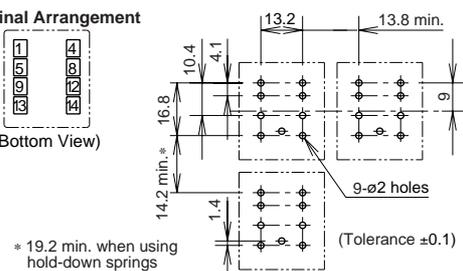
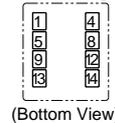

Relay Sockets

• SM2S-62

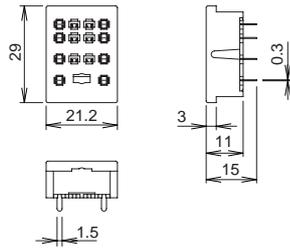

Terminal Arrangement

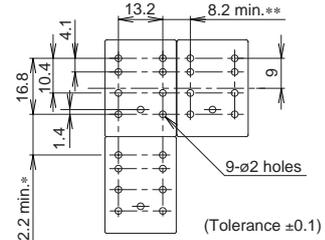
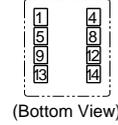

- * 17.2 min. when using a hold-down spring.
- ** 13.2 min. when using a hold-down spring for the relay with check button.

SY Series

• SY2S-61

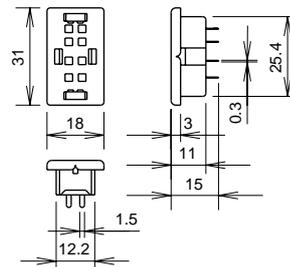

Terminal Arrangement

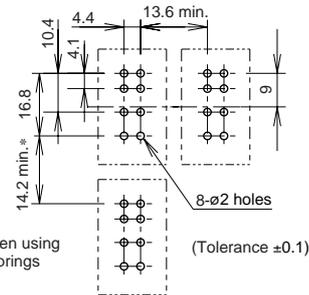
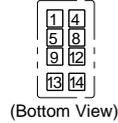

- * 19.2 min. when using hold-down springs

• SY4S-61

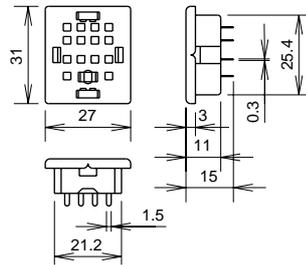

Terminal Arrangement

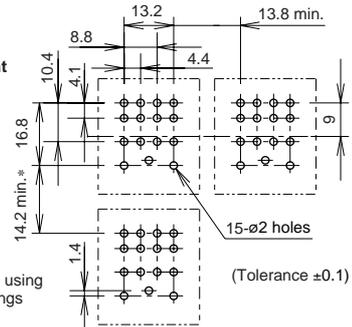
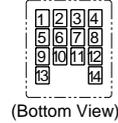

- * 19.2 min. when using hold-down springs

• SY4S-62

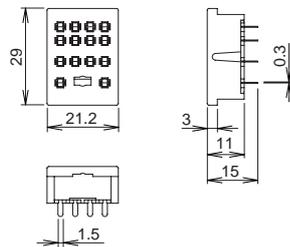

Terminal Arrangement

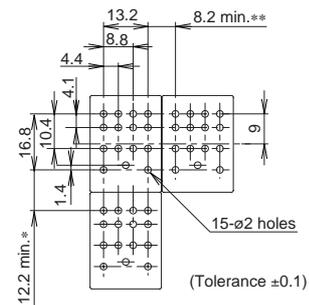
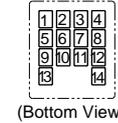

- * 17.2 min. when using a hold-down spring.
- ** 13.2 min. when using a hold-down spring for the relay with check button.

Relay Sockets

Accessories

DIN Rails

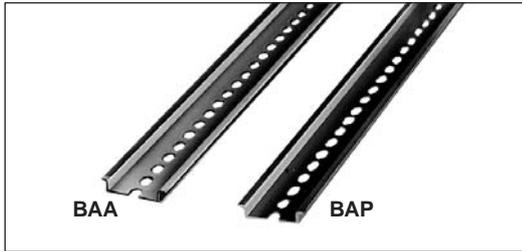

The BAA is a 35-mm-wide DIN rail made of durable extruded aluminum.

The BAP is a 35-mm-wide DIN rail made of rust proof sheet steel.

Material	Type No.	Ordering Type No.	Package Quantity
Aluminum	BAA1000	BAA1000PN10	10
Steel	BAP1000	BAP1000PN10	10

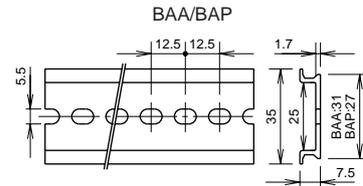

Mounting Clip

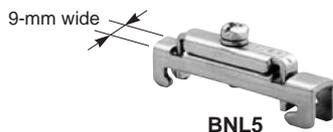

BNL5

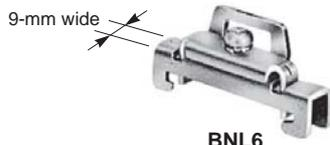

BNL6

Use of the BNL5 or BNL6 mounting clip is recommended at the both ends of the socket row mounted on the DIN rail to prevent the sockets from moving sideways.

Type No.	Ordering Type No.	Package Quantity
BNL5	BNL5PN10	10
BNL6	BNL6PN10	10

Application Example of Mounting Clip and DIN Rail Spacer

Use DIN rail spacers for adding space between adjoining sockets to prevent miswiring and identify wiring groups.

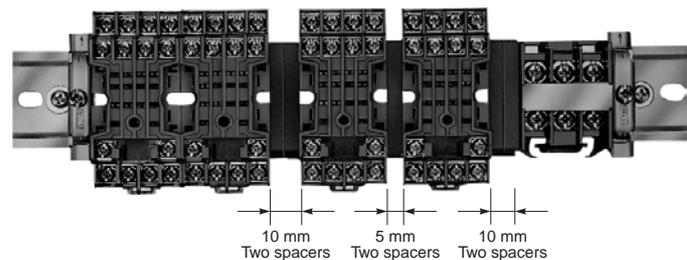

Installation of Mounting Clip and DIN Rail Spacer

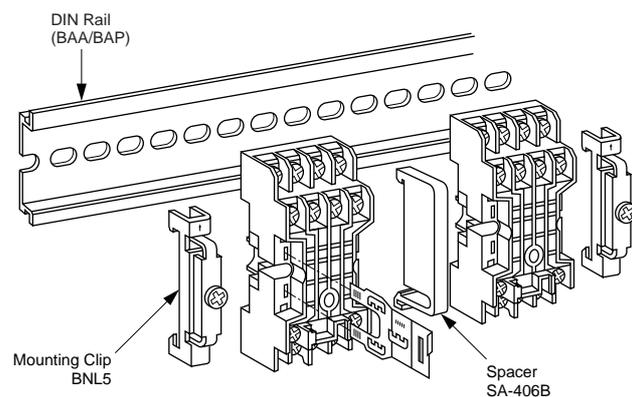

DIN Rail Spacer



Spacers of 5-mm thick are designed to provide spacing between DIN rail mount sockets when mounted on 35-mm wide DIN rails. The spacers snap on and off the rail like sockets.

Type No.	Package Quantity	Color
SA-406B	1	Black

Relay Sockets

Surface Mounting of DIN Rail Mount Socket

• End Spacer



Type No.	Package Quantity	Color
SA-203B	1	Black

• Intermediate Spacer



Type No.	Package Quantity	Color
SA-204B	1	Black

The end spacer and intermediate spacer are used for mounting DIN rail mount sockets on panel surfaces. In collective mounting using these spacers, screws can be eliminated at every other socket. Mounting centers are the same in single mounting and collective mounting.

Note: DIN rail mount sockets can also mount directly on panel surfaces without using these spacers, then the mounting centers are different from when using spacers.

Single Mounting Collective Mounting For saving the need for screw tightening and drilling

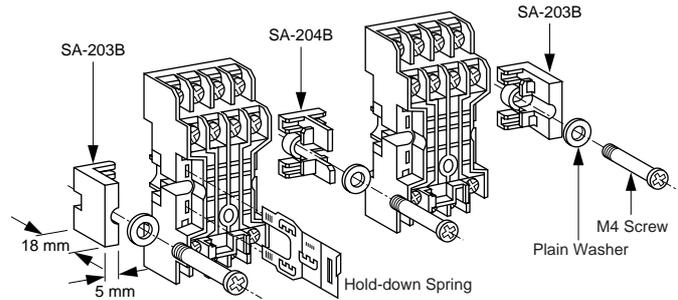
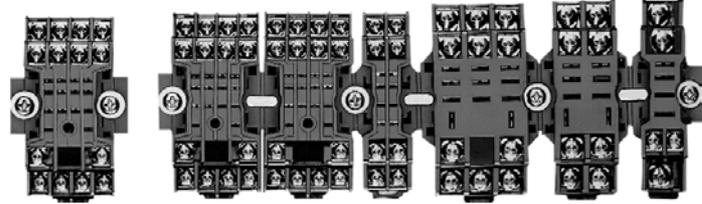

Socket	A (mm)
SR3B-05A	44
SH1B-05A	21
SH2B-05A	31
SH3B-05A	41
SH4B-05A	51
SM2S-05A	31
SY2S-05A	21
SY4S-05A	31

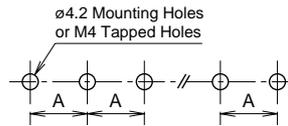

Collective Mounting of Panel Mount Sockets

The SY, SM, and SH series panel mount sockets are designed to mount in panel cut-outs collectively. These sockets can be mounted in the same panel cut-out due to the standardized size.

• Mounting into Panel Cut-out

To mount, insert the sockets with mounting springs facing top and bottom edges of the panel cut-out. Push the mounting spring using a screwdriver until the mounting spring clicks into the panel.

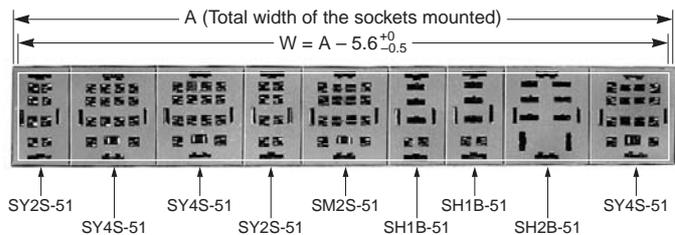
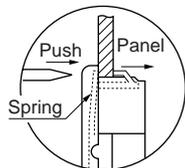

$$\text{Panel cut-out width } W = 18 + 27 + 27 + 18 + 27 + 18 + 18 + 27 + 27 - 5.6 = 201.4^{+0}_{-0.5}$$

• Socket Width

Socket	Width
SH1B-51	18 mm
SH2B-51	27 mm
SH3B-51	36 mm
SH4B-51	45 mm
SM2S-51	27 mm
SY2S-51	18 mm
SY4S-51	27 mm

SU Series Sockets: General Instructions

For photos and dimensions, see page 48.

Parts Description

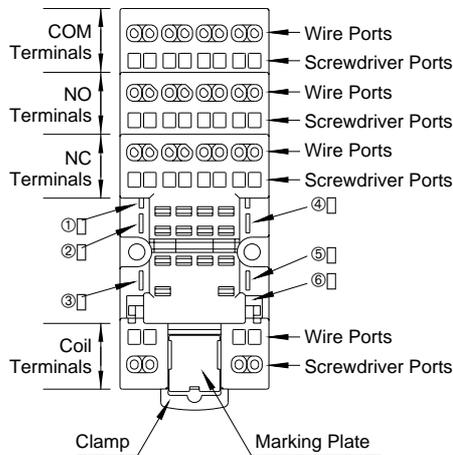

①②⑤⑥: Spring slots for SFA-101 leaf springs
②③④⑤: Spring slots for SFA-202 leaf springs

Applicable Wires

Wire	Size
Stranded Wire	0.2 to 1.25 mm ² or AWG24 to 16
Solid Wire	0.2 to 1.5 mm ² or AWG24 to 16
Wire Insulation Diameter	ø3.15 mm maximum

- Strip the wire insulation 9 to 10 mm from the end.

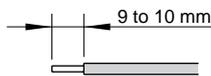

- In applications using ferrules for stranded wires, choose the ferrule listed in the table below. Make sure that an insulation sheath is applied when using the ferrules. When using stranded wires without ferrules, make sure that the core wires have not been loosened.

Applicable Ferrules

Applicable Wire (stranded)		Type No.	Manufacturer
mm ²	AWG		
0.25	24	AI 0.25-12BU	Phoenix Contact
	—	22	
0.5	20	AI 0.5-8WH	
		AI 0.5-10WH	

Applicable Screwdriver

- For wiring, use the optional screwdriver (BC1S-SD0) or the following applicable screwdriver.

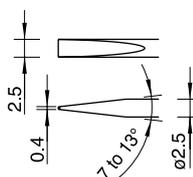

All dimensions in mm.

Wiring Instructions

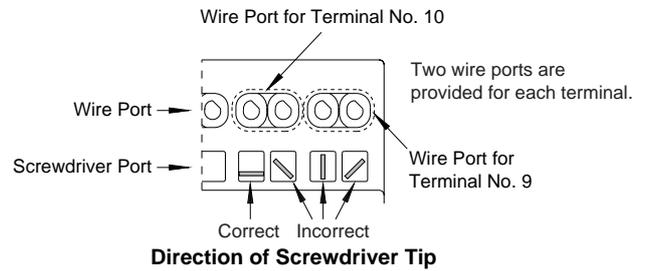

1. Insert the optional screwdriver (BC1S-SD0) or an applicable screwdriver into the square-shaped port as shown, until the screw-driver tip touches the bottom of the spring.

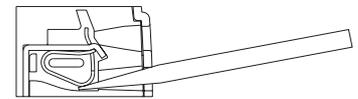

2. Push in the screwdriver until it touches the bottom of the port. The wire port is now open, and the screwdriver is held in place. The screwdriver will not come off even if you release your hand.

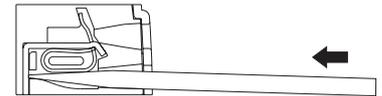

3. While the screwdriver is retained in the port, insert the wire or ferrule into the round-shaped wire port. Each wire port can accommodate one wire or ferrule. When connecting two wires to one terminal, use the adjoining port of the same terminal.

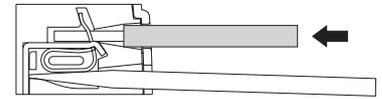

4. Pull out the screwdriver. The connection is now complete.

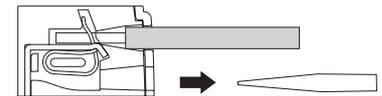

- When using thin wires with insulation diameter of ø1.6 mm or less, do not insert the wire too deeply where the insulation inserts into the spring clamp opening. Make sure that the wire insulation is stripped 9 to 10 mm and the wire is inserted to the bottom.

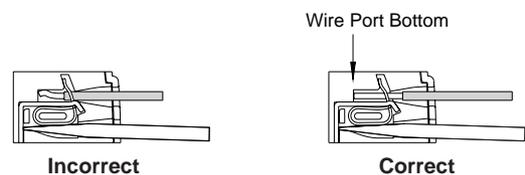

- Do not twist the screwdriver inserted into the screwdriver port in the socket, otherwise the socket may break.

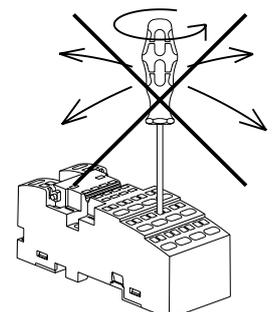

Relay Sockets

Marking Plate

Write markings on the SU sockets using an oil-based marker, or glue printed mylar on the marking surface. The size of the printed mylar can be 8 × 9 mm maximum.

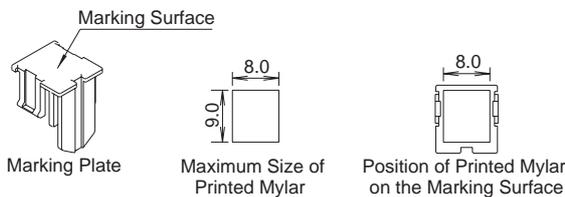

• Installing the Marking Plate

Because of its removable structure, the marking plate may have fallen from the socket or become loose in delivery. Make sure that the marking plate is securely installed before starting operation. The marking plate protects the conductive portion of the socket, located under the marking plate, by preventing metal fragments or pieces of wire from dropping inside. Should any such fragments enter the socket, they may cause fire hazard, damage, or malfunction.

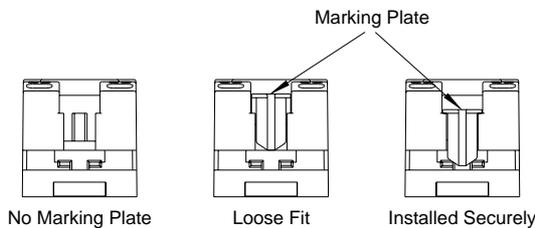

SU9Z-J5 Jumper for SU2S-11L and SU4S-11L

The SU9Z-J5 is used to install five sockets. When installing less than five sockets, cut the jumper according to the instructions described below.

The SU9Z-J5 is for coil terminals only.

• SU9Z-J5 Jumper Specifications

Rated Current	3A	
Material	Conductor	Nickel-plated brass
	Sheath	ABS resin

• Installing the SU9Z-J5 Jumper

Loosen the marking plate on the socket.

Making sure that the SU9Z-J5 jumper is correctly aligned, insert the blades into the ports in the groove of the SU socket.

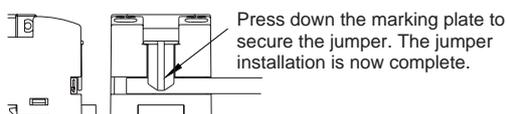
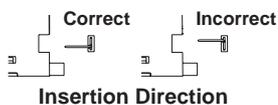
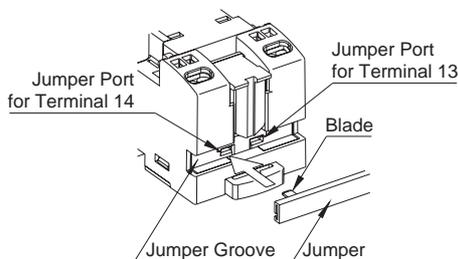

• Installing the SU9Z-J5 Jumper on Two, Three, or Four SU Sockets

As shown below, slide the jumper in the sheath so that the jumper aligns with the center of the sheath.



With the sheath properly installed on the jumper, cut the sheath and jumper at the points shown below, using cutting pliers. Referring to the drawing on the below right, make sure that the sheath and jumper are cut within the cutting area. Dispose of unused portions according to local waste disposal requirements.

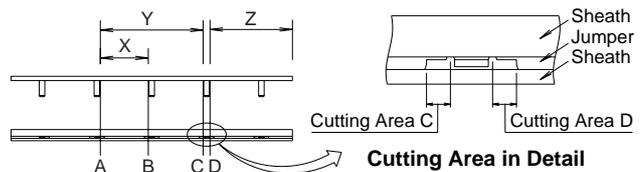

For Connecting	Jumper Quantity	Cutting Area	Discard
2 sockets	2	A, C	Y
2 sockets	1	A, B	X
3 sockets	1	A, B	X
4 sockets	1	D	Z

After cutting the jumper and sheath, slide the jumper as shown below, so that the ends of the jumper are not exposed.

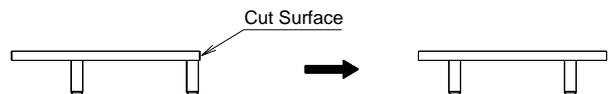

• Jumper Wiring to Six or More SU Sockets

To jumper wire six or more SU sockets, connect five sockets using whole jumpers and the remaining sockets using a cut jumper. Then connect the two terminals on adjoining sockets using an applicable wire (see table below).

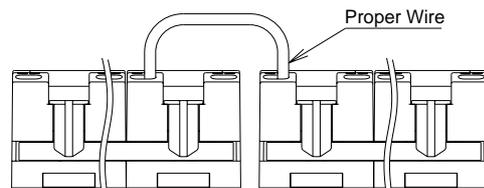

Jumper Wiring of Terminal 14 between Adjoining Sockets

Wire	Size
Stranded Wire	0.2 to 1.25 mm ²
Solid Wire	0.2 to 1.5 mm ²
AWG	24 to 16

Note 1: Use a wire with cable insulation diameter of $\varnothing 3.15$ mm maximum.

Note 2: Strip the cable insulation 9 to 10 mm from the end.

Safety Precautions

Turn off the power to the SU9Z-J5 jumper before starting installation, removal, wiring, maintenance, or inspection of the jumper, failure to turn power off may cause an electrical shock or fire hazard.

To avoid a short circuit due to incorrect wiring, confirm which terminals are connected to the jumper before starting wiring.

Optional Function Modules

Module	Type No.	Ordering Type No.	Rated Voltage	Polarity	Function	Package Quantity
Diode Module	SU9Z-D11	SU9Z-D11PN10	6 to 220V DC	A1: Negative A2: Positive	For absorbing surge voltages in DC coils. Since the diode module has polarity, connect DC voltage to terminals A1 and A2 correctly, otherwise the relay does not operate.	10
	SU9Z-D12	SU9Z-D12PN10		A1: Positive A2: Negative		10
RC Module	SU9Z-R21	SU9Z-R21PN10	6 to 240V AC	—	For absorbing surge voltages in AC coils.	10
LED Module	SU9Z-L31	SU9Z-L31PN10	6 to 12V AC/DC	Non-polarized LED	Non-polarized LED indicator; goes on when the relay coil is energized.	10
	SU9Z-L32	SU9Z-L32PN10	24 to 48V AC/DC			10
	SU9Z-L33	SU9Z-L33PN10	100 to 120V AC/DC			10
	SU9Z-L34	SU9Z-L34PN10	200 to 240V AC/DC			10

The diode module and RC module are for absorbing the counter emf generated in the relay coil. If the relay coil is subjected to excessive external surge voltages, provide a separate surge protection device to prevent damage to the internal surge absorbing element. Do not disassemble the function module, otherwise the module may be damaged.

• Installing the Optional Function Module

Turn power off to the SU socket before starting installation, removal, wiring, maintenance, and inspection. Otherwise the devices may be damaged or electrical shocks may occur.

① Remove the marking plate from the socket.

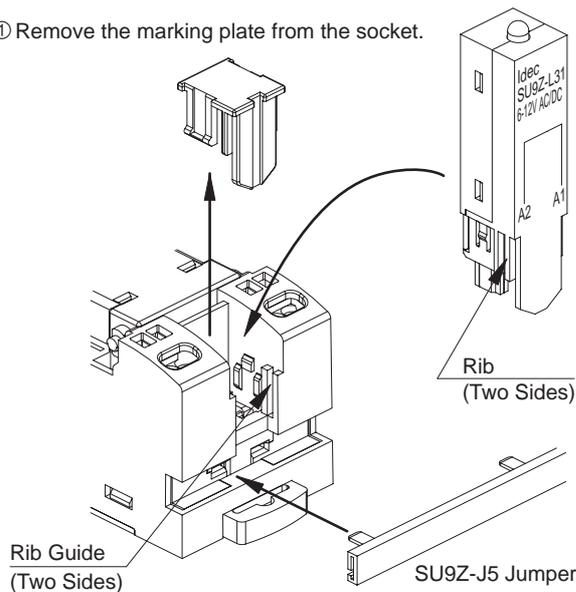

② When using the SU9Z-J5 jumper, insert the jumper before installing the module.

③ With the marking surface outside, insert the module to the bottom.

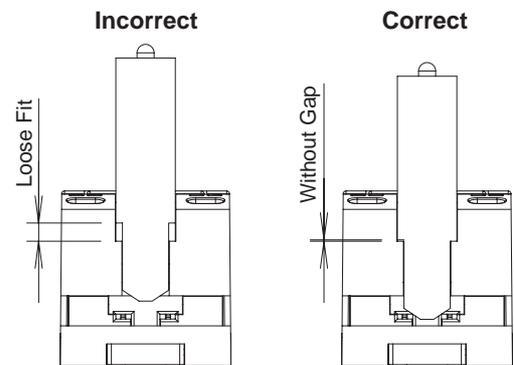

Insertion Complete

Relay Sockets

Specifications and other descriptions in this leaflet are subject to change without notice.



IDEC IZUMI CORPORATION

IDEC CORPORATION (USA)

1175 Elko Drive, Sunnyvale, CA 94089-2209, USA
Tel: +1-408-747-0550, Toll Free: (800) 262-IDECC, Fax: +1-408-744-9055
E-mail: opencontact@idec.com, www.idec.com

IDEC CANADA LIMITED

Unit 22-151, Brunel Road Mississauga, Ontario, L4Z 1X3, Canada
Tel: +1-905-890-8561, Toll Free: (888) 317-4332, Fax: +1-905-890-8562

IDEC ELECTRONICS LIMITED

Unit 2, Beechwood, Chineham Business Park, Basingstoke, Hampshire
RG24 8WA, UK
Tel: +44-1256-321000, Fax: +44-1256-327755
E-mail: idec@uk.idec.com

IDEC ELEKTROTECHNIK GmbH

Wendenstraße 331, D-20537 Hamburg, Germany
Tel: +49-40-25 30 54-0, Fax: +49-40-25 30 54-24
E-mail: service@idec.de, www.idec.de

IDEC AUSTRALIA PTY. LTD.

2/3 Macro Court, Rowville, Victoria 3178, Australia
Toll Free: 1-800-68-4332, Fax: +61-3-9763-3255
E-mail: sales@au.idec.com

7-31, Nishi-Miyahara 1-Chome, Yodogawa-ku, Osaka 532-8550, Japan
Tel: +81-6-6398-2571, Fax: +81-6-6392-9731
www.idec.com

IDEC IZUMI ASIA PTE. LTD.

No. 31, Tannery Lane #05-01, Dragon Land Building, Singapore 347788
Tel: +65-6746-1155, Fax: +65-6844-5995
E-mail: generalinfo@idecasia.com.sg

IDEC IZUMI (H.K.) CO., LTD.

Room 1409, Tower 1, Silvercord, 30 Canton Road, Tsimshatsui, Kowloon,
Hong Kong
Tel: +852-2-376-2823, Fax: +852-2-376-0790
E-mail: idec@idechk.com

IDEC IZUMI (Shanghai) Co., Ltd.

Room E, 15F, Majesty Building, No. 138 Pudong Avenue,
Shanghai 200120, P.R.C.
Tel: +86-21-5887-9181, Fax: +86-21-5887-8930
E-mail: idec@cn.idec.com

IDEC TAIWAN CORPORATION

8F, No. 79, Hsin Tai Wu Road, Sec. 1, Hsi-Chih, Taipei County, Taiwan
Tel: +886-2-2698-3929, Fax: +886-2-2698-3931
E-mail: service@idectwn.com.tw