

Think Automation and beyond...



RV8H *New* Interface Relays



IDEC CORPORATION

Ultra-slim interface relays

Suitable for high density mounting

- Screw and spring clamp terminals
- Release lever for easy locking and removal of relay



- Green LED indicator
- 6A contact capacity in the slim housing
- Gold-plated contacts for high contact reliability
- Minimum applicable load: 6V DC, 10mA
- 12 coil voltage types to meet various needs

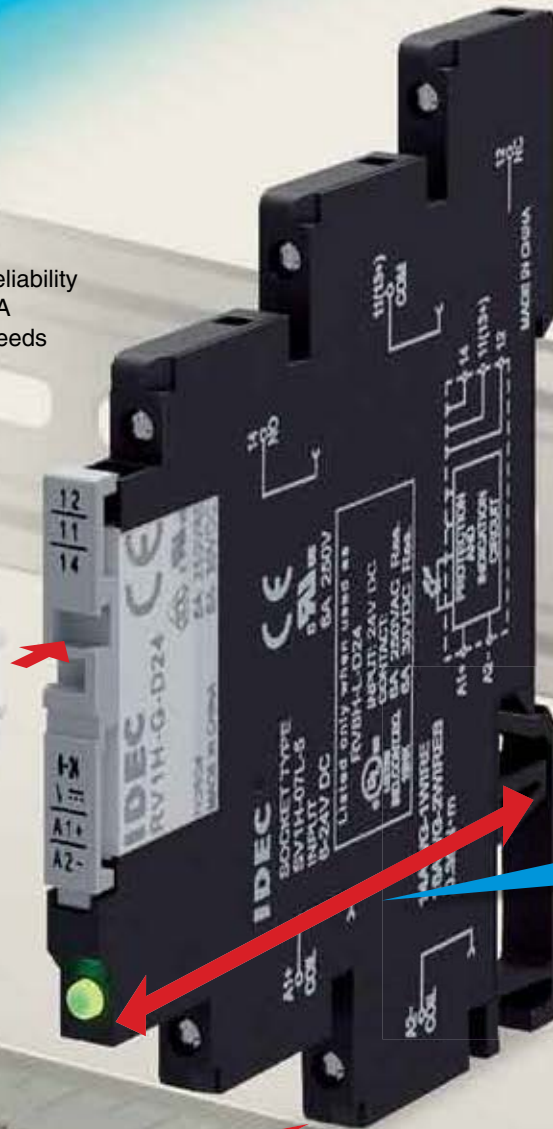

Marking plate
can be installed
on the release
lever.

Only **70** mm
from the DIN rail
Shortest in its class

Slim Width
6 mm

RV8H

Interface Relays

RV8H Interface Relays

Space-saving 6mm width suitable for high density mounting.

- Screw and spring clamp terminals available
- Release lever for easy locking and removal of relay
- Green LED indicator
- 6A contact capacity in a slim housing
- Gold-plated contacts for high contact reliability
- Wide input voltage range: 6 to 240V
- Marking plate can be installed on the release lever



Applicable Standards	Mark	Certification Organization / File No.
UL508 CSA C22.2 No. 14		UL listed, File No. E55996
EN61810-1		VDE No. 40030148 (RV1H relay only)
		EU Low Voltage Directive

Interface Relays

Package Quantity: 1

Contact Arrangement	Coil Voltage	Part No.	
		Screw Terminal	Spring Clamp Terminal
SPDT	6V DC	RV8H-L-D6	RV8H-S-D6
	9V DC	RV8H-L-D9	RV8H-S-D9
	12V DC	RV8H-L-D12	RV8H-S-D12
	18V DC	RV8H-L-D18	RV8H-S-D18
	24V DC	RV8H-L-D24	RV8H-S-D24
	12V AC/DC	RV8H-L-AD12	RV8H-S-AD12
	18V AC/DC	RV8H-L-AD18	RV8H-S-AD18
	24V AC/DC	RV8H-L-AD24	RV8H-S-AD24
	48V AC/DC	RV8H-L-AD48	RV8H-S-AD48
	60V AC/DC	RV8H-L-AD60	RV8H-S-AD60
	110-125V AC/DC	RV8H-L-AD110	RV8H-S-AD110
	220-240V AC/DC	RV8H-L-AD220	RV8H-S-AD220

Accessories

Relay / Socket

Package Quantity: 1











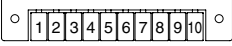





















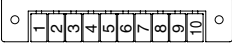











Screw Terminal		
Interface Relay Complete Part No.	Applicable Socket Part No.	Applicable Relay Part No.
	SV1H-07L-5	RV1H-G-D5
RV8H-L-D9		RV1H-G-D9
RV8H-L-D12		RV1H-G-D12
RV8H-L-D18		RV1H-G-D18
RV8H-L-D24		RV1H-G-D24
RV8H-L-AD12	SV1H-07L-1	RV1H-G-D12
RV8H-L-AD18		RV1H-G-D18
RV8H-L-AD24		RV1H-G-D24
RV8H-L-AD48		RV1H-G-D48
RV8H-L-AD60	SV1H-07L-2	RV1H-G-D60
RV8H-L-AD110	SV1H-07L-3	RV1H-G-D60
RV8H-L-AD220	SV1H-07L-4	RV1H-G-D60

Spring Clamp Terminal		
Interface Relay Complete Part No.	Applicable Socket Part No.	Applicable Relay Part No.
	SV1H-07LS-5	RV1H-G-D5
RV8H-S-D9		RV1H-G-D9
RV8H-S-D12		RV1H-G-D12
RV8H-S-D18		RV1H-G-D18
RV8H-S-D24		RV1H-G-D24
RV8H-S-AD12	SV1H-07LS-1	RV1H-G-D12
RV8H-S-AD18		RV1H-G-D18
RV8H-S-AD24		RV1H-G-D24
RV8H-S-AD48		RV1H-G-D48
RV8H-S-AD60	SV1H-07LS-2	RV1H-G-D60
RV8H-S-AD110	SV1H-07LS-3	RV1H-G-D60
RV8H-S-AD220	SV1H-07LS-4	RV1H-G-D60

RV8H Interface Relays

Marking Plate

Package Quantity: 1

Shape	Marking										Part No.	
No marking  Material: PBT (white)	Blank										SV9Z-PW10	
Vertical laser marking  Material: PBT (white)	1	2	3	4	5	6	7	8	9	10	SV9Z-PW10-V1-10	
	11	12	13	14	15	16	17	18	19	20	SV9Z-PW10-V11-20	
	21	22	23	24	25	26	27	28	29	30	SV9Z-PW10-V21-30	
	31	32	33	34	35	36	37	38	39	40	SV9Z-PW10-V31-40	
	41	42	43	44	45	46	47	48	49	50	SV9Z-PW10-V41-50	
	51	52	53	54	55	56	57	58	59	60	SV9Z-PW10-V51-60	
	61	62	63	64	65	66	67	68	69	70	SV9Z-PW10-V61-70	
	71	72	73	74	75	76	77	78	79	80	SV9Z-PW10-V71-80	
	81	82	83	84	85	86	87	88	89	90	SV9Z-PW10-V81-90	
	91	92	93	94	95	96	97	98	99	100	SV9Z-PW10-V91-100	
	A	B	C	D	E	F	G	H	I	J	SV9Z-PW10-VA-J	
	K	L	M	N	O	P	Q	R	S	T	SV9Z-PW10-VK-T	
	U	V	W	X	Y	Z					SV9Z-PW10-VU-Z	
												SV9Z-PW10-VGROUND
												SV9Z-PW10-VAC
	Horizontal laser marking  Material: PBT (white)	1	2	3	4	5	6	7	8	9	10	SV9Z-PW10-H1-10
		11	12	13	14	15	16	17	18	19	20	SV9Z-PW10-H11-20
		21	22	23	24	25	26	27	28	29	30	SV9Z-PW10-H21-30
		31	32	33	34	35	36	37	38	39	40	SV9Z-PW10-H31-40
41		42	43	44	45	46	47	48	49	50	SV9Z-PW10-H41-50	
51		52	53	54	55	56	57	58	59	60	SV9Z-PW10-H51-60	
61		62	63	64	65	66	67	68	69	70	SV9Z-PW10-H61-70	
71		72	73	74	75	76	77	78	79	80	SV9Z-PW10-H71-80	
81		82	83	84	85	86	87	88	89	90	SV9Z-PW10-H81-90	
91		92	93	94	95	96	97	98	99	100	SV9Z-PW10-H91-100	
A		B	C	D	E	F	G	H	I	J	SV9Z-PW10-HA-J	
K		L	M	N	O	P	Q	R	S	T	SV9Z-PW10-HK-T	
U		V	W	X	Y	Z					SV9Z-PW10-HU-Z	
												SV9Z-PW10-HGROUND
												SV9Z-PW10-HAC

Shape	Material	Part No.	Package Quantity	Note
Jumper Rated current: 6A (Note) 	Brass (nickel-plated) with polyamide sheath Approx. 6g	SV9Z-J20*PN10	10	Specify a color code in place of * in the Part No. B: black W: gray S: blue Can be cut to required length. No. of points: 20
DIN Rail Spacer	Polyamide (gray)	SV9Z-SA2W	1	Used for adjusting spacing between sockets and to prevent the ends of jumpers from exposing.

Note: Ensure that the total current to the jumper does not exceed the rated current.

Contact Ratings

Allowable Contact Power		Rated Load			Allowable Switching Current	Allowable Switching Voltage	Minimum Applicable Load
Resistive Load	Inductive Load	Voltage	Resistive Load	Inductive Load			
1,500VA AC 180W DC	B300/R300 (pilot duty)	250V AC 30V DC	6A 6A	B300/R300 (pilot duty)	6A	400V AC 125V DC	6V DC, 10 mA (reference value)

Coil Ratings

Rated Voltage (V)	Coil Voltage Code	Rated Current (mA) ±15% (at 23°C) (Note)	Coil Resistance (Ω) ±15% (at 23°C) (Note)	Impedance (Ω) ±15% (at 23°C)	Operating Characteristics (against rated values at 23°C)			Power Consumption	
					Maximum Continuous Applied Voltage (Note)	Minimum Pickup Voltage	Dropout Voltage		
DC	6V DC	D6	35	170	110%	90% maximum	7% minimum	0.21	
	9V DC	D9	18.6	485				0.2	
	12V DC	D12	14.6	820				0.25	
	18V DC	D18	11.6	1,550				0.2	
	24V DC	D24	10.6	2,270				0.25	
AC/DC	12V AC/DC	AD12	15.5	800				755	0.2
	18V AC/DC	AD18	13.3	1,345				1,365	0.25
	24V AC/DC	AD24	13.7	1,790				1,730	0.33
	48V AC/DC	AD48	4.0	12,230				11,880	0.2
	60V AC/DC	AD60	3.4	17,910				17,600	0.5
	110-125V AC/DC	AD110	3.4-3.9	32,450-32,900	31,790-31,890	0.85			
	220-240V AC/DC	AD220	3.3-3.6	65,940-68,570	65,670-66,070	0.85			

Note: D12 and below: ±10%

UL and c-UL Ratings

Voltage	Resistive	Inductive
250V AC	6A	B300/R300 (pilot duty)
30V DC	6A	

VDE Ratings (RV1H relay only)

Voltage	Resistive
250V AC	6A
30V DC	6A

Applicable Ferrules

Applicable Wire (stranded)		Part No.	Manufacturer
mm ²	AWG		
0.5	20	AI0.5-8WH	Phoenix Contact
0.75	18	AI0.75-8GY	
1	18	AI1-8RD	
0.5	22	TE0.5-8	Nichifu
0.75	20	TE0.75-8	
1	18	TE1.0-8	

Specifications

Part No.	RV8H-L (Screw Terminal)	RV8H-S (Spring Clamp Terminal)
Number of Poles	1-pole	
Contact Configuration	SPDT	
Contact Material	Silver alloy (gold-plated)	
Degree of Protection	Relay: IP67, Socket: IP20 (IEC 60529)	
Contact Resistance (initial value)	100mΩ maximum	
Operate Time	15ms maximum	
Release Time	20ms maximum	
Insulation Resistance	1,000MΩ minimum (500V DC megger)	
Dielectric Strength	Between contact and coil	4,000V AC, 1 minute
	Between contacts of the same pole	1,000V AC, 1 minute
Vibration Resistance	Operation extremes	10 to 55 Hz, amplitude 0.5mm (NO contact), 0.2mm (NC contact)
	Damage Limits	10 to 55 Hz, amplitude 0.5mm (NO contact), 0.2mm (NC contact)
Shock Resistance	Operation extremes	49 m/s ² (NO contact), 29.4 m/s ² (NC contact)
	Damage Limits	980 m/s ²
Electrical Life (rated load)	30,000 operations minimum (NO contact), 10,000 operations minimum (NC contact) (250V AC/30V DC, 6A resistive load, operation frequency 1,800 operations per hour)	
Mechanical Life (no load)	10 million operations minimum (operation frequency 18,000 operations/hour)	
Operating Temperature	RV8H-*D6, D9, D12, D18, D24, AD12, AD18, AD24, AD48, AD60: -40 to +70°C (no freezing) RV8H-*AD110, AD220: -40 to +55°C (no freezing)	
Operating Humidity	5 to 85% RH (no condensation)	
Storage Temperature	-40 to +85°C (no freezing)	
Storage Humidity	5 to 85% RH (no condensation)	
Weight (approx.)	30g	26g

RV8H Interface Relays

Dimensions

All dimensions in mm.

Screw Terminal RV8H-L

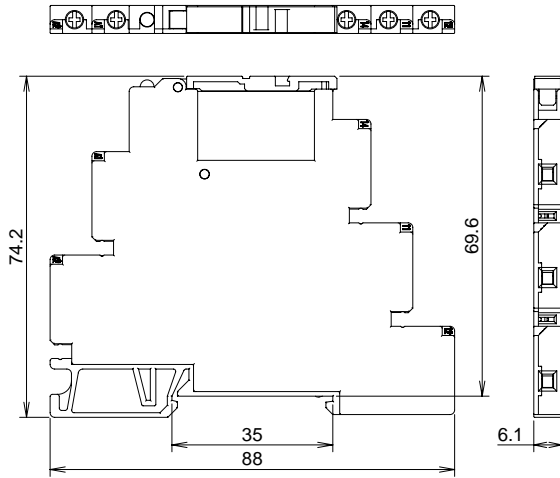

Spring Clamp Terminal RV8H-S

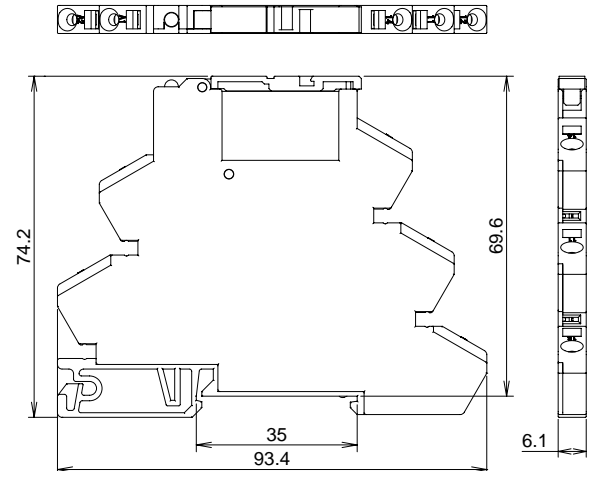

Jumper SV9Z-J20*PN10

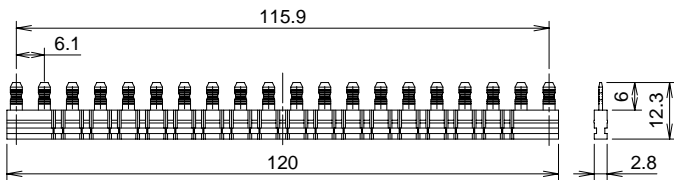

DIN Rail Spacer SV9Z-SA2W

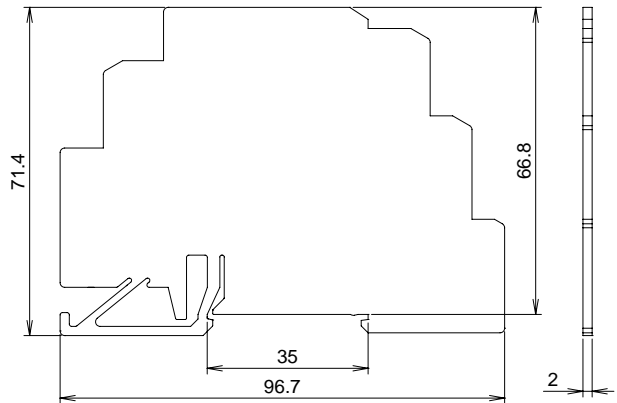

Marking Plate SV9Z-PW10

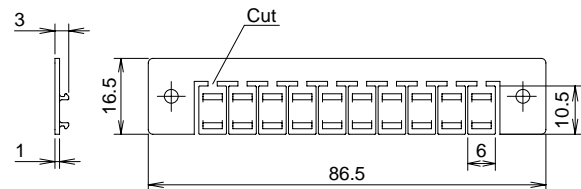

Installing a marking plate

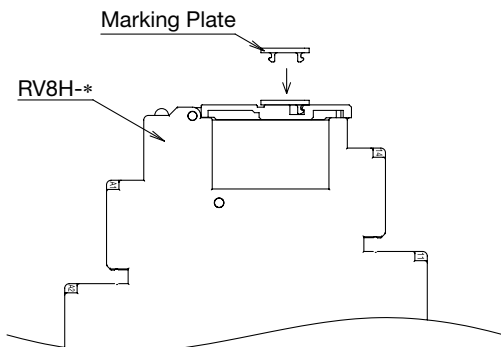

RV1H Internal Connection (bottom view)

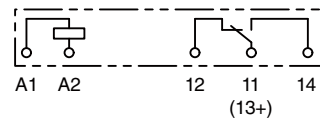

RV8H Internal Connection

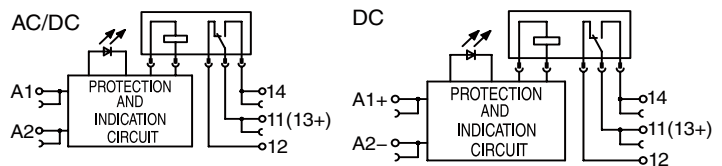

Specifications and other descriptions in this catalog are subject to change without notice.



IDEC CORPORATION

7-31, Nishi-Miyahara 1-Chome, Yodogawa-ku, Osaka 532-8550, Japan
Tel: +81-6-6398-2571, Fax: +81-6-6392-9731
E-mail: marketing@idec.co.jp

IDEC CORPORATION (USA)
Tel: +1-408-747-0550 / (800) 262-IDEC (4332)
E-mail: opencontact@idec.com
IDEC CANADA LIMITED
Tel: +1-905-890-8561, Toll Free: (800) 262-IDEC (4332)
E-mail: sales@ca.idec.com
IDEC AUSTRALIA PTY. LTD.
Tel: +61-3-8523-5900, Toll Free: 1800-68-4332
E-mail: sales@au.idec.com

IDEC ELECTRONICS LIMITED
Tel: +44-1256-321000 E-mail: sales@uk.idec.com
IDEC ELEKTROTECHNIK GmbH
Tel: +49-40-25 30 54 - 0 E-mail: service@idec.de
IDEC (SHANGHAI) CORPORATION
Tel: +86-21-6135-1515 E-mail: idec@cn.idec.com
IDEC (BEIJING) CORPORATION
Tel: +86-10-6581-6131

IDEC (SHENZHEN) CORPORATION
Tel: +86-755-8356-2977
IDEC IZUMI (H.K.) CO., LTD.
Tel: +852-2803-8989 E-mail: info@hk.idec.com
IDEC TAIWAN CORPORATION
Tel: +886-2-2698-3929 E-mail: service@tw.idec.com
IDEC IZUMI ASIA PTE. LTD.
Tel: +65-6746-1155 E-mail: info@sg.idec.com

www.idec.com