

The major advantages of the MAC motors are:

- High performance
- Cost effective
- Decentral intelligence
- Quiet and maintenance free operation
- High efficiency
- Low operational cost
- Less machine space required
- Low installation cost. Shorter and faster installation
- Fewer possibilities for wiring errors
- Minimum positioning error during operation and halt
- Modular flexibility
- New users can easily set up the system

Main features (basic MAC models)

- Ideal for high volume applications in harsh industrial environments
- Accepts position and velocity commands sent via 2 serial interfaces
- Genuine AC-servomotor with high torque at high speed
- Pulse and direction input makes it possible to replace any step motor
- Quadrature output to master controller when used as a  $\pm 10V$  driver
- Switching technology in motor and power supplies
- High performance serial protocol with addressing facilities
- Easy and simple Windows program available for installation/set-up

### The complete range of MAC motors®

The complete range of JVL AC servo, integrated MAC motors offer you a wide selection of motor sizes adaptable to a wide range of applications

## The MAC motor - 50 to 134 W - the complete motion solution for smaller powers ratings

Brushless servo motor with integrated controller everything in one unit, except power supply.

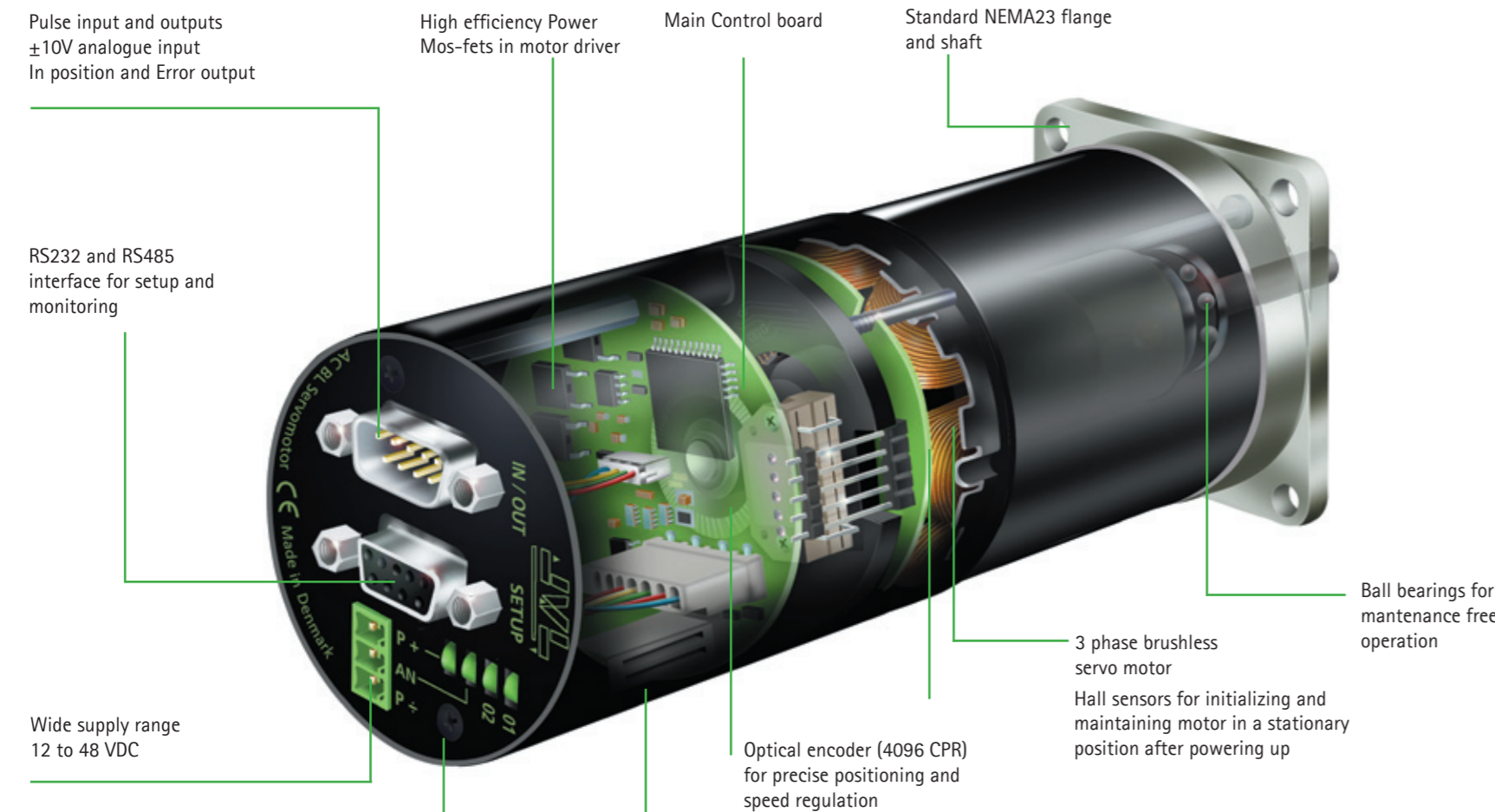

### Cables

Cables for all types of set up can be delivered as required. In this way installation is fast and easy for our customers

### Electronic brake

Optionally an electronic brake, type MAB23x, can be mounted on all motors with a NEMA23 flange and 6.35mm shaft. It is useful for holding the motor shaft fixed at power off or when the motor is used in a vertical application

### IP67 Protection

IP67 versions can also be delivered. They are resistant against rough chemicals and ideal for use in food processing, pharmaceutical and chemical industries. A double shaft seal and leak-proof cable entry provide watertight sealing

### Power Supplies

JVL can supply a wide range of power supplies for supplying one or several MAC motors. They range from very simple do-it-yourself kits to big switch mode supplies. It should be noted that MAC800 includes a complete 115/230 VAC power supply for driver voltage. Only 24VDC for control circuit is required externally

## Adapt your motor to your application

The JVL Integrated motors utilizes the unique module concept. Plug-in expansion modules adapt the motor to the application. You can choose connector type, D-Sub, cable glands or M12 connectors and you can choose freely between Profibus, DeviceNet, CANopen or nano PLC control. A High

Speed and wireless modules add to the possibilities. This means that you have possibilities as with no other motors on the market, and also important, you only pay for what you need. Moreover, if you do not find the feature you need please contact us and we will develop a customized module for you.

### Basic Modules

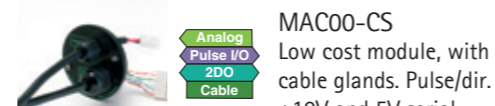

Pulse/Dir  
Analog

### Wireless Modules



### Field Bus Modules

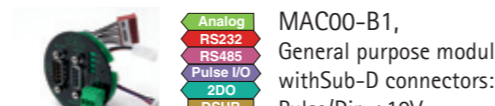

RS 232  
485

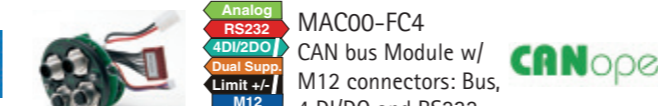

CANopen

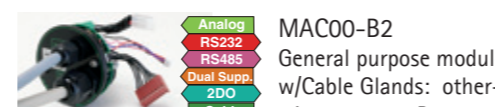

RS 232  
485



DeviceNet



RS 232  
485

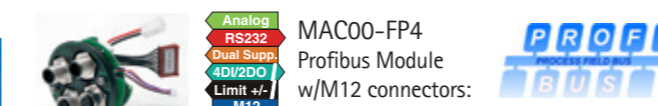

PROFIBUS

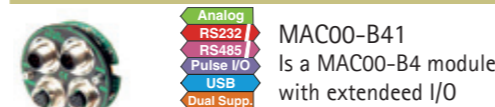

RS 232  
485

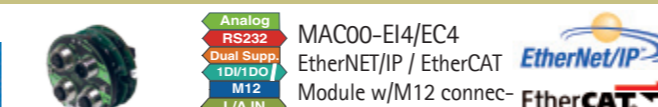

EtherNet/IP  
EtherCAT

### Programmable Modules



PLC  
NANO



### High Speed Multi-Axis modules

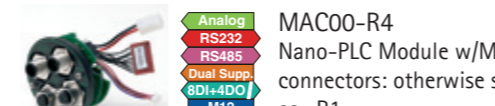

PLC  
NANO

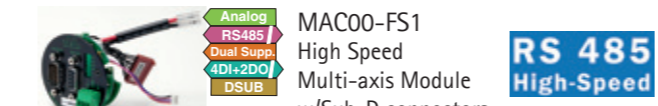

RS 485  
High-Speed

### Process Control Modules

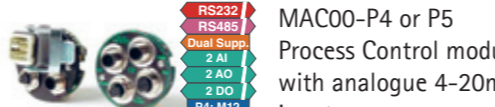

PROCESS  
Control

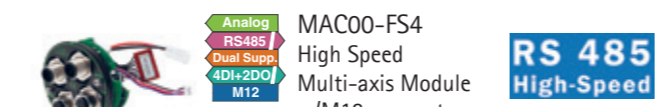

RS 485  
High-Speed

DSUB 9 or 15-pin DSUB connectors IP42  
Cable Shielded cable up to 20 m IP67  
M12 M12 screw connector. Cable up to 20 m. IP67  
Dual Supp. Position and parameters can be maintained under emergency stop

Analog.  $\pm 10V$  for speed or torque control or 24V home switch  
Pulse IO RS422 balanced inputs for pulse/direction incremental signal or encoder output  
Limit +/- 2 of the inputs can be used as negative or positive limit switch inputs. = Optocouplers.

## The MAC motor - 400 W and 750 W - the complete solution for medium and larger power ratings

Brushless servo motor with integrated controller everything in one unit including mains power supply

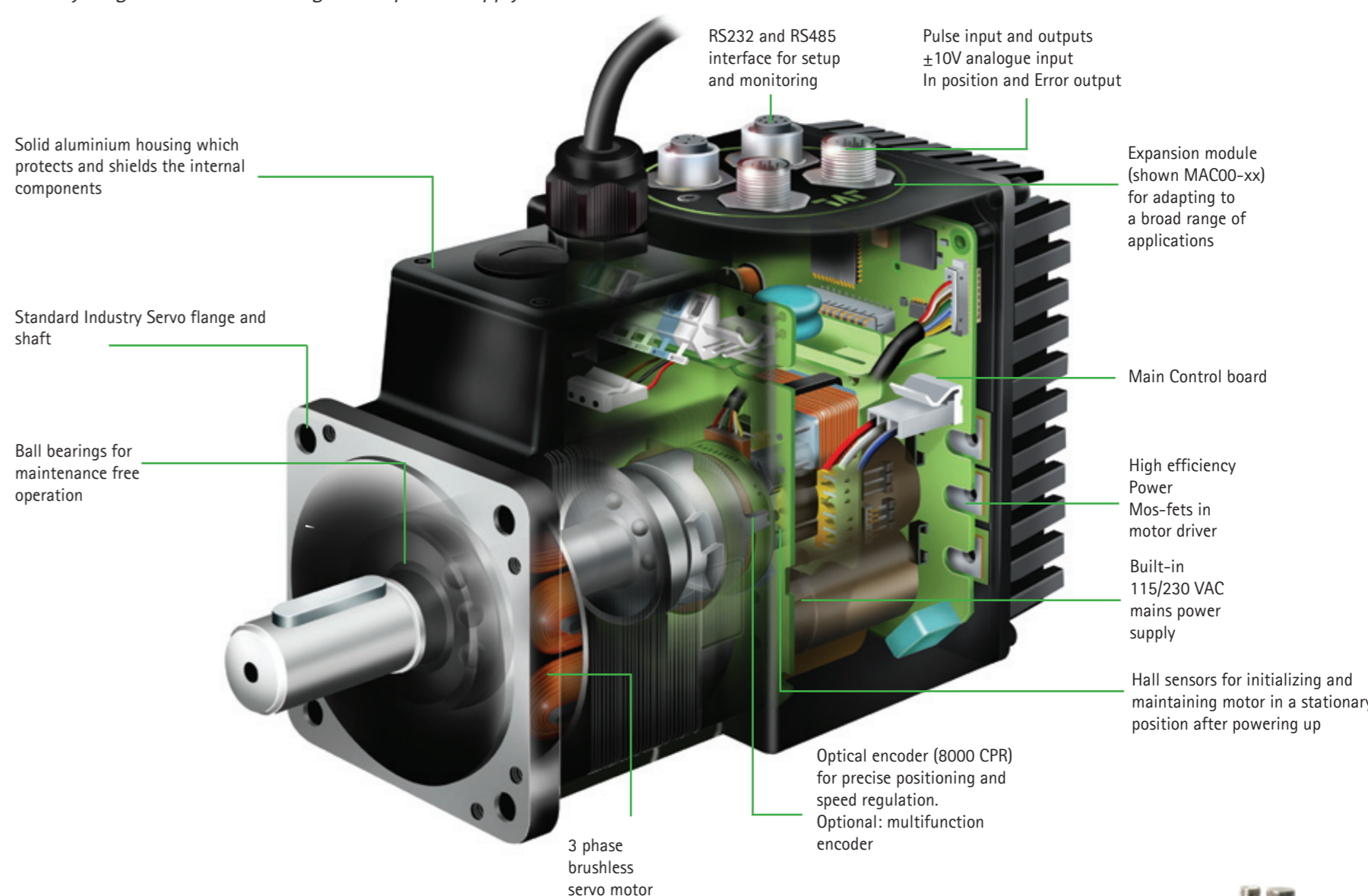

### Gears

A wide range of planetary, worm and backlash free gears can be provided for the MAC motors

### Built-in Brake

For applications in which motor position must be maintained at power-off, or for use in vertical applications, the 400 and 750W MAC motors can be supplied with a built-in brake

### MAC1500 and MAC3000

Soon available. They will extend the MAC motor power range to 3000 W. Present series of expansion modules will still fit in these larger motors

### MAC400

MAC400 for medium power ratings with incremental encoder or multi-turn encoder for precise positioning and speed regulation

### Other applications

- Replacement for pneumatic solutions
- Replacement of step motors offering much faster response and speed
- Conveyor systems
- Printing machines
- 3-D and XY tables
- Replacement for frequency inverters
- $\pm 10V$  speed/torque driver for external controllers
- Screw and toothed belt pick and place robots
- Labelling dispensers

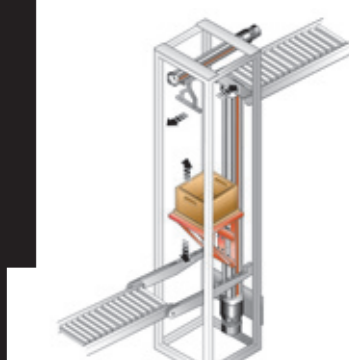

Material Handling Systems vertical and horizontal transfer movements

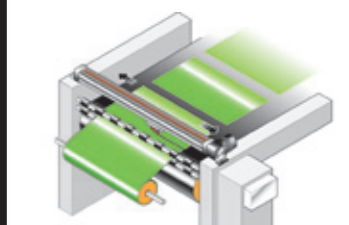

Slitting Machines. High speed traverse applications for slicing materials

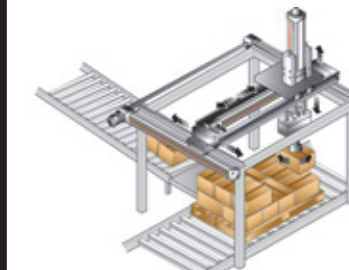

Auto Handling. High speed pick and place movements

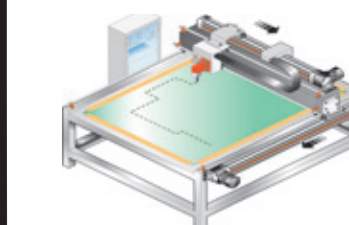

Profile Cutting Machines Intricate profile movements of water jets and laser cutters

# Software

JVL delivers the software that you need!

## MacTalk

For setup, monitoring and diagnostics MacTalk is the preferred choice for most users.

Although advanced functionality is included, all operations are very intuitive and easy to use.

MacTalk allows you to adjust all vital parameters and save them in a file- or load them from a file. It is also possible to monitor parameters and motor status in real time.

When commissioning a system MacTalk even provides a convenient way to test and adjust your system. You can easily set up a test sequence and then adjust parameters like velocity, acceleration and torque. It is possible to select the distance moved and the delay between the moves. The more advanced 6th-order filter used in MAC motors, instead of a simple PID loop, is easily adjusted.

A nice feature is the Update function: if your PC is connected to the Internet you can update the MacTalk software itself – and even the servo system's firmware can be updated both the driver and the expansion module. Once bought, MacTalk will stay "fresh".

– always including the latest functionality.

## Graphical Programming

The Nano PLC MAC00-Rx module can be programmed from MacTalk using userfriendly, icon-based commands in a graphical programming environment. With 8 inputs 4 outputs, all 5-24VDC, and one ±10V analogue input, a small PLC system can be programmed. It is register-based with different kinds of relative or absolute movements, Jump and IF commands, timer and other functions. It is possible to request input conditions and set outputs.

All register and parameters in the MAC motor can be accessed and changed if required.

- Visual Basic
- Visual C++
- Visual .Net
- Delphi
- Borland C++ Builder
- LabView
- Excel

any other environment supporting OXCX controls.

## OCX software

If your application is controlled by a PC you might prefer JVL's OCX software. The OCX (OLE Custom Controls – also known as ActiveX Controls) enables applications to be easily developed in for example:

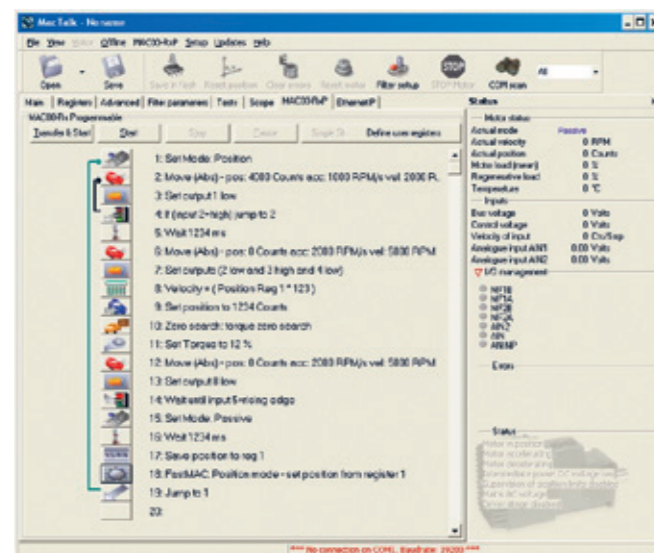
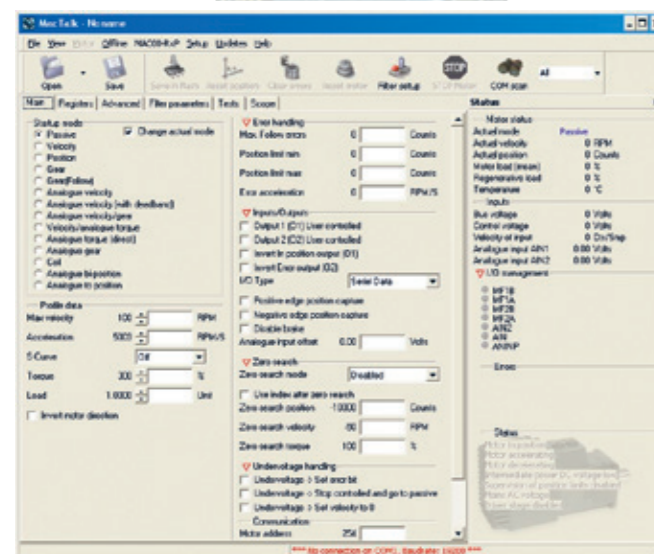

# Specifications

Technical specifications	MAC50	MAC95	MAC140	MAC141	MAC400-D2	MAC800-D2	MAC1500-D2	MAC3000-D2	Unit
Supply voltage	12-48VDC	12-48VDC	12-48VDC	12-48VDC	115/230VAC	115/230VAC	3x400VAC	3x400VAC	VAC
Speed range (nominal)	0-4000	0-4000	0-4000	0-4000	0-3000	0-3000	0-3000	0-3000	RPM
Rated power @ 4000/3000 RPM	46/0.062	92/0.124	134/0.18	134/0.18	400/0.54	746/1	1500/2	3000/4	W/hp
Cont. torque @ Tamb = -25°C	0.11/15.6	0.22/31.1	0.32/45.3	0.48/68	1.3/184.1	2.38/337.1	4.78/677	9.55/1352.4	Nm/oz-in.
Peak torque @ Tamb = -25°C	0.32/45.3	0.62/87.8	0.9/127.5	1.59/225.2	3.8/538.13	6.8/963	14.3/2025	28.6/4050.1	Nm/oz-in.
Rotor inertia	0.075/0.0010	0.119/0.0017	0.17/0.0024	0.23/0.0033	0.34/0.0048	0.91/0.0129	6.26/0.0886	12.14/0.1719	kgcm <sup>2</sup> /oz-in <sup>2</sup>
Encoder resolution (standard)	4096	4096	4096	4096	8000/8192	8000	32767	32767	CPR
Absolute Encoder (Single / Turns)					8192/4096	8192/4096	8192/4096	8192/4096	CPR/Rev
Physical dimensions: MAC050-141 (dia x length) MAC400-3000 (wide x height x length)	Ø59x112/ 2.32x4.41	Ø59x131/ 2.32x5.16	Ø59x153/ 2.32x6.02	Ø59x172/ 2.32x6.77	60x114x191/ 2.36x4.48x7.52 with brake	80x115x175/ 3.15x4.53x6.89 with brake	130x200x182/ 5.12x7.87x7.16	130x200x232/ 5.12x7.87x9.13	mm/inch
Weight without exp. module	0.6/1.32	0.85/1.87	1.1/2.43	1.33/2.93	2.3/5.1	3.5/7.72	6.5/14.33	10.5/23.15	kg/lb
Protection class		IP42/IP67 optional			IP55 (IP66 on request)	IP55 (IP66 on request)	IP55 (IP66 on request)		
Flange		58.7x58.7/2.32x2.32			60x60/2.36x2.36	80x80/3.15x3.15	130x130/5.12x5.12		mm/inch
Shaft		Ø6.35/0.25 (other diameter on request)			Ø14/0.55	Ø19/0.75	Ø24/0.95		mm/inch

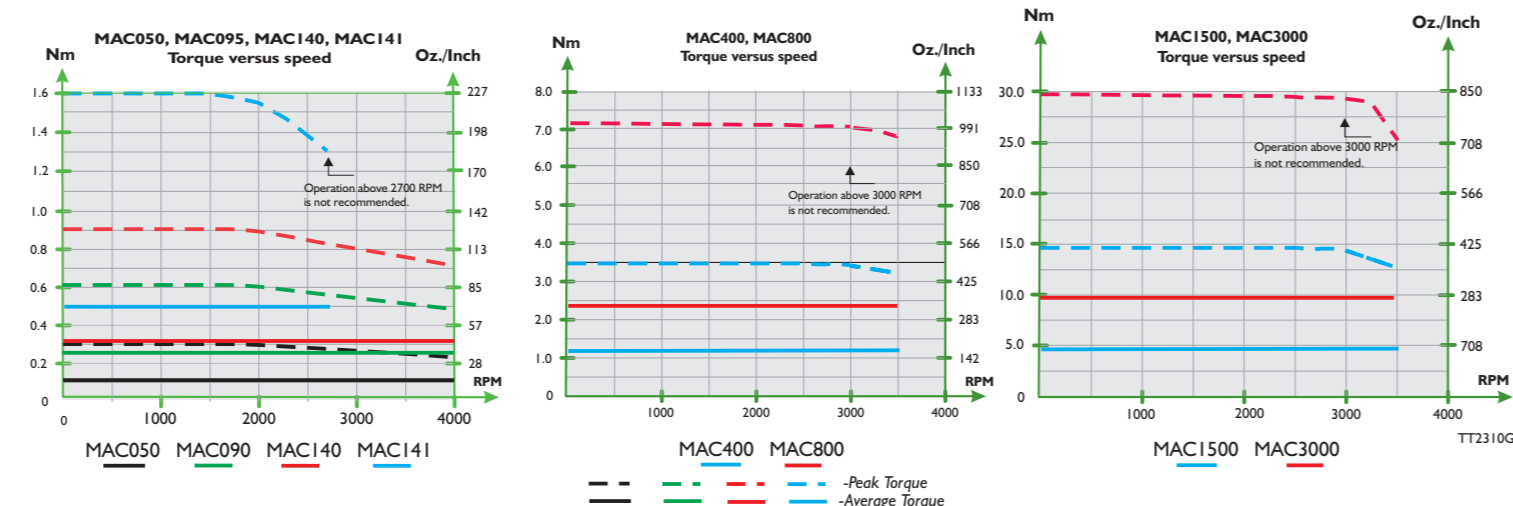

# MAC motor® – Integrated Servo Motor



# Save Money and Troubles

In the past building up a motion control system was a complicated affair involving many components:

- PLC
  - Indexer/controller
  - Driver
  - Motor with Encoder and Hall sensor
  - A lot of cabling to connect all these items
- and finally complicated software that had to be programmed properly

In these motors the Indexer/controller, Driver, Encoder and Hall sensor are all built-in into one compact unit.

A software package, MacTalk, makes set-up extremely easy and expansion modules mounts directly into the motorhousing to adapt the motor to almost any application.

By investing in a modern integrated MAC motor from JVL you achieve the following benefits:

- Reduced material costs. Because the drive and controller are in the motor, most cabling to a control panel is eliminated
- Reduced labor costs. With cabling eliminated, assembly time is greatly reduced
- Better quality and reliability
- Fewer connections, less wiring

- Ease of serviceability. Because all electronics are self-contained you simply change the motor
- Double supply facility to ensure that position and parameters are maintained after emergency stop
- Switching noise from the drive due to commutation is contained in the motor
- Reduced setup time. 6th order digital filter requires only one tuning parameter for load or reflected inertia
- OEM cost savings, the modular approach means you only pay for the functionality required

It required a lot of expertise to make the system function and the installation was very time consuming and involved many sources that could create faults. Electrical noise from the cables carrying the high motor currents added to the problems.

JVL has reduced these problems to a minimum by introducing of the Integrated MAC motor on the motion control market.

### Previous system build-up

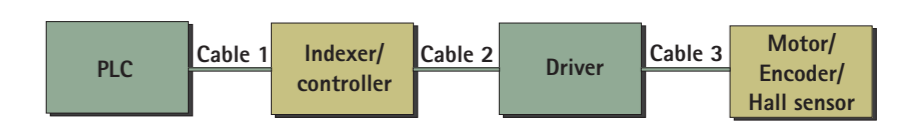

### Modern system build-up



# A new way of saving money All Electronics Inside

Brushless servo motors  
with integrated controller



## JVL Industri Elektronik A/S

JVL Industri Elektronik A/S is a modern company, located in Birkerød, just north of Copenhagen. The up-to-date development, research and production facilities of JVL employ only the latest technology for the development and production of electronic controls for step- and servo motors. More than 50% of the staff are engineers with a very high degree of experience and competence in the field of motion control. We can therefore offer a product

programme that includes all the necessary units and components to build up a complete motor control system. JVL is represented throughout Europe and Asia by independent agents and in USA by a sister company, JVL International ApS. In Germany we have our own offices, JVL Deutschland. All distributors are carefully selected by JVL to have the necessary knowledge and experience to help our customers in the best possible way in their choice of motion control components.



JVL Industri Elektronik A/S  
Blokken 42  
DK-3460 Birkerød, Denmark  
Tel: +45 4582 4440  
Fax: +45 4582 5550  
E-mail: jvl@jvl.dk  
www.jvl.dk

JVL Deutschland  
Tel: +49 711 51878564  
Fax: +49 711 51878565  
E-mail: jvl@jvl.de  
www.jvldeives.de

JVL USA & Canada  
JVL International  
Tel: +1 513 877 3134  
Fax: +1 513 877 2471  
E-mail: jvl@jvlusa.com  
www.jvlusa.com