



MACH4 Label Printer.

Made in Germany.

Product type overview for MACH4.

B with tear-off plate

A minimum label height of 30 mm is required for it to be torn off.

Printing method	Thermal transfer / Thermal direct		
Print resolution dpi	203	300	600
Print speed up to mm/s	200	200	100
Print width up to mm	104	105.6	105.6



P with tear-off plate and dispensing function

The label height on dispensing is 20 – 200 mm.

Printing method	Thermal transfer / Thermal direct		
Print resolution dpi	203	300	600
Print speed up to mm/s	200	200	100
Print width up to mm	104	105.6	105.6



C with tear-off plate and cutter

Labels or continuous material can be cut at a height of just 12 mm.

Printing method	Thermal transfer / Thermal direct		
Print resolution dpi	203	300	600
Print speed up to mm/s	200	200	100
Print width up to mm	104	105.6	105.6



Options:

24 volt battery operation

For battery operation, a control PCB with 24 V battery is built in instead of a power supply unit. This means that the printer can be used on the move. As a result, the print speed is limited to 100 mm/s. The battery capacity is sufficient for at least one working day.

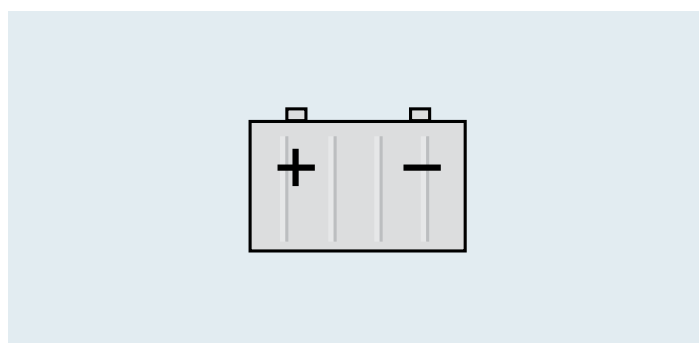

RFID read/write unit

The label printers can also be equipped with an RFID read/write unit for transponders in Smart labels with 13.56 MHz in line with ISO 15693.



Key features.

- › The future “made by cab”: MACH4, the new label printer that sets new benchmarks.
- › It offers all the features of a high class industrial printer with a wide application range.
- › Labels and ribbons can be inserted from the front. The print mechanism and housing are made of premium materials and are perfectly harmonized in their form and function.
- › Easy and comfortable handling and high reliability were the requirements during development. The large display with white backlight offers optimum readability.
- › The navigation pad with the additional “Enter” button simplifies operation, with only the operated functions being displayed.
- › The centered label path eliminates the need for adjustments and avoids wrinkling of the ribbon.
- › The high-tech electronic board incorporates all the requisite interfaces as standard and works with all kinds of adapters.



Technical details.

1 Cover with large window

Can be opened wide. The integrated cushioning mechanism ensures smooth closing. The label stock is visible at all times.

2 Media hub

The roll is inserted into the media hub and centered automatically. Materials of different widths fit easily within the box.

3 Ribbon retainer

The ribbon can be slid onto a ribbon supply hub with spring mounted brackets. It can be centered with a movable flange and a positioning indicator. The ribbon can be inserted quickly and easily into the print mechanism.

4 Print mechanism

It can be opened at the push of a button and offers easy access.

5 Printing with 203, 300 or 600 dpi

The printheads can switch easily between 203 and 300 dpi. The printer detects the resolution automatically.

6 Gap sensor

To detect the beginning or end of labels, the gap sensor is mounted in the center of the label path. With multi-track labels, the user can switch to another sensor that is shifted 10 mm sideways.

7 Label guide

The adjustment knob can be used to adjust the width of the printing area in order to center the labels.

8 Reflex sensor

The adjustable reflex sensor can be used to identify the start of a label, print marks and cut-outs

9 Drive roller

The drive roller can be easily removed for cleaning or replacement.

10 Peel-off plate

The liner is guided down behind the operation panel. The label is removed from its liner at the peel-off-plate.

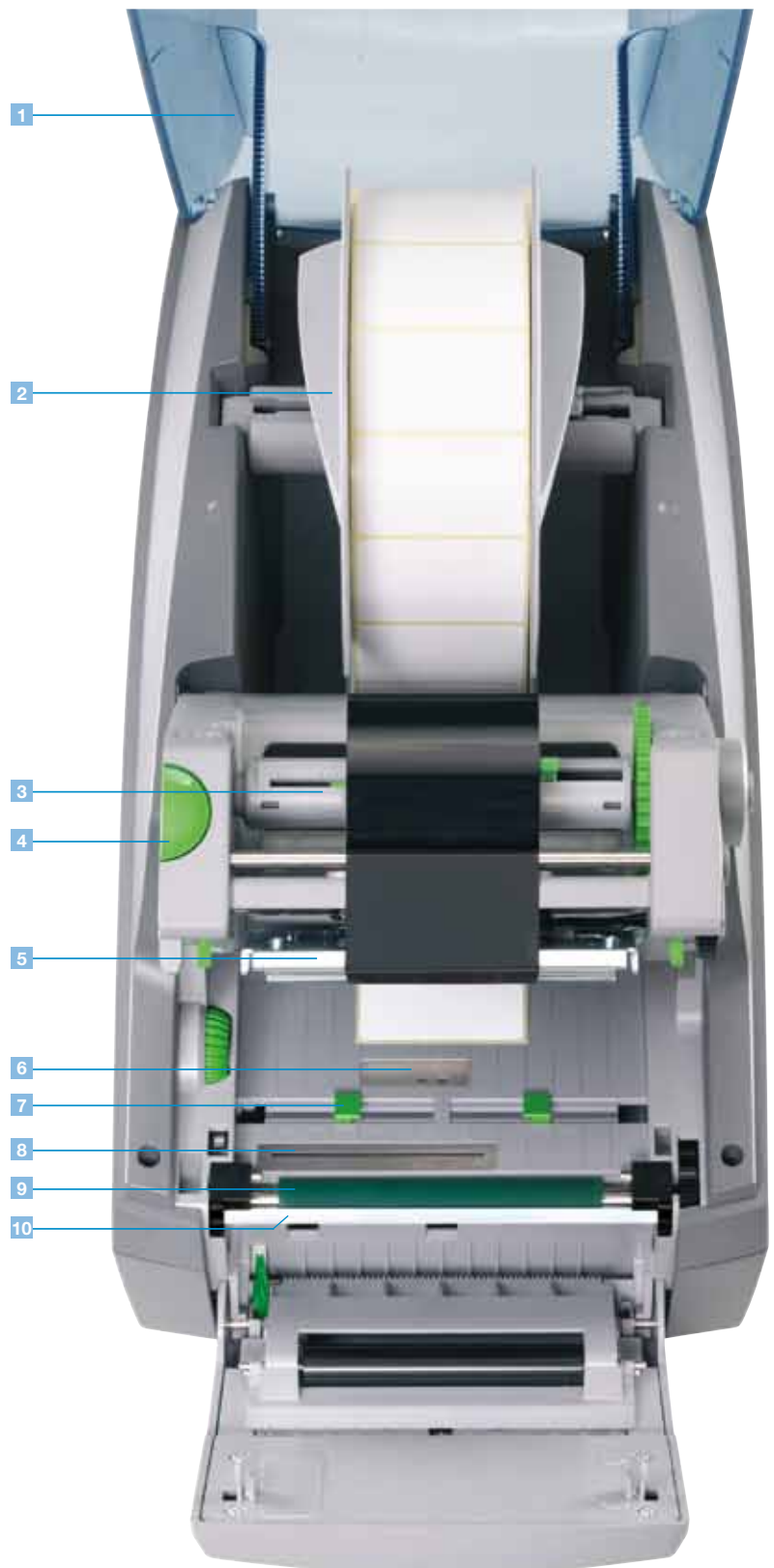



Interfaces.



Rear of printer

- 1 RS232C interface.
- 2 USB 2.0 slave interface.
- 3 Ethernet 10/100 Base T interface with TCP/IP.
- 4 Slot for wireless LAN card.
- 5 Two USB master interfaces for connecting an external operation panel, keyboard, scanner, USB flash drive or service key.
- 6 Slot for CompactFlash Type I memory card.

Options

- 
 - › Centronics bi-directional interface acc. to IEEE 1284.
 - RS422/RS485 interface 1,200 to 230,400 Baud/8 Bit.
 - The interfaces are plugged into the PC.
 - Connection to the printer via mini USB connection cable.
- 
 - › Label selection – I/O box.
 - Up to 16 different labels can be loaded via PLC from a memory card. Operation of four inputs/outputs via Basic Interpreter.
- 
 - › cab WLAN card 802.11 b/g.

Stand-alone operation.

Printing with a cab printer without a PC.

The layout of the labels is created either using label software or through direct programming via a text editor on the PC. Label formats, fonts and graphic data, serial data and database contents are saved or imported on the CF memory card, USB flash drive or the internal IFFS printer memory.

Only variable data is sent to the printer via keyboard or host computer before being printed out. Data from a barcode scanner or a balance can also be received by the printer.



Accessories for stand-alone operation



Memory card

CompactFlash Type I



Standard keyboard

Connection: USB,
number of keys: 115

Device functionality and compliance with CE standards are only warranted by using the accessories provided or recommended by cab.

Technical data.

■ Standard □ Option

Label printer		MACH4		
Printhead	Printing method Thermal transfer	■	■	■
	Thermal direct	■	■	–
	Print resolution dpi	203	300	600
	Print speed up to mm/s	200	200	100
	Print width mm	104	105.6	105.6
Material	Labels, continuous rolls or fan-folded	Paper, cardboard, textile, plastics such as PET, PE, PP, PVC, PU, acrylate, PI		
	Material thickness mm / weight g / m ²	0.055 – 0.8 / 60 – 200		
	Label width ¹⁾ mm	6 – 116		
	Width of carrier or continuous material mm	25 – 120 / from 0.4 mm material thickness 5 – 120		
	Label height ¹⁾ mm	5 – 4500		
	when dispensing ¹⁾ from mm	20		
	Material height when cutting ¹⁾ from mm	12		
	Media roll Total diameter up to mm	205		
	Core diameter mm	38 – 100		
	Winding direction	Outside or inside		
Ribbon	Ink	Outside or inside		
	Roll diameter up to mm	72		
	Core diameter mm	25		
	Ribbon length variable up to m	360		
	Width ²⁾ up to mm	114		
Printer dimensions	Height x Depth x Width mm	312 x 435 x 240		
	Weight kg	6		
Label sensor	Gap sensor Position	For label edge or punching mark and end of material centered or shifted 10 mm to the left		
	Reflective sensor ³⁾ Position	For label edge, punching or centered printing mark adjustable 56 mm to the left / 10 mm to the right		
Electronics	Processor high speed 32 Bit ColdFire/clock rate MHz	266		
	RAM MB	64		
	Memory IFFS MB Flash	8		
	Slot for CompactFlash Type I memory card	■		
	Slot for wireless LAN card	■		
	Battery buffer for	Real-time clock, printout of time and date Data storage on shut-down		
	Warning signal	Acoustic signal in case of error		
Interfaces	Centronics bi-directional acc. to IEEE 1284	□		
	RS232 C 1,200 up to 230,400 Baud/8 Bit	■		
	USB 2.0 high speed slave for PC connection	■		
	Ethernet 10 / 100 Base T, LPD, RawIP printing, ftp printing, DHCP, HTTP, FTP, SMTP, SNMP, TIME, Zeroconf, mDNS, SOAP	■		
	RS422, RS485 1,200 up to 230,400 Baud / 8 Bit	□		
	WLAN card 802.11b/g WEP/WPA PSK (TKIP)	□		
	2 x USB master for	For external operation panel, keyboard, scanner, service key, USB flash drive		
Operating data		100 – 240 V		24 VDC
	Power supply	~ 50 / 60 Hz, PFC		
	Energy consumption	Max. 300 W		Max. 250 W
	Operating temperature	10 – 35°C		10 – 35°C
	Humidity	30 – 85% not condensing		30 – 85% not condensing
	Approvals	CE, FCC class A, CB, CCC, UL		CE, more on request

¹⁾ Limitations may apply to small labels, thin materials or strong adhesives. Critical materials or applications must be tested and approved.

²⁾ The ribbon should be roughly the same width as the label in order to avoid folding.

³⁾ Reflective sensor with RFID not available.

Label printer		MACH4	
Operation panel	Buttons/LED display	Pause, Feed, Cancel, Menu, Enter, 4 x Cursor	
	LCD graphic display	Width 60 mm, height 40 mm, text 4 lines, ca. 20 characters per line	
Settings		Time, date, digital or analog clock 25 language settings System settings, print parameters, interfaces, security	
Monitoring	Stop printing if:	End of ribbon End of labels Printhead open	
	On the display	Data reception Clock WLAN field intensity Date sheet Ethernet status abc Debug	Used memory Input buffer Temperature of printhead Remaining quantity of ribbon Access to memory card
Test routines	System diagnosis	When switched on incl. printhead testing	
	Short status, status print	Font list, device list, WLAN status, profile of label, test grid, monitor mode, PPP status	
	Status reports	Extensive status printout with information about settings, e.g. print length counter, runtime counter, etc. Request of machine status via software commands. Detailed status messages on the display, e.g. network error – no link, barcode error, etc.	
Fonts	Font types	5 Bitmap fonts incl. OCR-A, OCR-B and 3 Vector fonts Swiss 721, Swiss 721 Bold and Monospace 821 available internally, loadable TrueType fonts. Thai and Chinese (simplified Chinese) available as options.i	
	Character sets	Windows 1250 up to 1257, DOS 437, 737, 775, 850, 852, 857, 862, 864, 866, 869, EBC DIC 500, ISO 8859-1 to -10 and -13 up to -16, WinOEM 720, UTF-8, Macintosh Roman, DEC MCS, KOI8-R. All West and East European Latin, Cyrillic, Greek, Hebrew and Arabic characters are supported. Thai and Chinese available as options.	
	Bitmap fonts	Size of width and height 1 – 3 mm Zoom 2 – 10 Orientation 0°, 90°, 180°, 270°	
	Vector / TrueType fonts	Size of width and height 0.9 – 128 mm Variable zoom, Orientation 360° in steps of 1°	
	Font formats	Bold, italic, underlined, outline, negative, gray, vertical, depending on character fonts	
Graphics	Graphic elements	Line, arrow, box, circle, ellipse, filled and filled with fading	
	Graphic formats	PCX, IMG, BMP, TIF, MAC, GIF, PNG	
Barcodes	Linear barcodes	Code 39, Code 93 Code 39 Full ASCII Code 128 A, B, C EAN 8, 13 EAN / UCC 128 EAN / UPC Appendix 2 EAN / UPC Appendix 5 FIM HIBC	Interleaved 2 / 5 Ident- and lead code of Deutsche Post AG Codabar JAN 8, 13 MSI Plessey Postnet RSS 14 UPC A, E, E0
	2D codes	Aztec, Codablock F, Data Matrix, PDF 417, Micro PDF 417, UPS Maxicode, QR-Code, RSS 14 truncated, limited, stacked and stacked omnidirectional, EAN-Datamatrix, GS1 Data Bar All codes variable in height, module width and ratio. Orientation 0°, 90°, 180°, 270°. Optionally with check digit, printed characters and start/stop code, depending on code type.	
Software	Programming	J-Script direct programming abc-Basic Compiler Database Connector	■ ■ □
	System diagnosis / Administration	Printer monitoring Network Manager	■ □
	Label software	cablabel R2+ Codesoft, NiceLabel, Easylabel Bartender, Label Matrix, Labelview	■ ○□ ○
	Windows driver certified	32 / 64 bit for Windows XP Server 2003 Windows Vista Server 2008 Windows 7 Server 2008 R2 Windows 8 Server 2012	■
	Mac driver	OS X printer driver from version 10.6	■
	Linux driver	CUPS-based from version 1.2	■
	Stand-alone operation		■

For current data, please go to www.cab.de/en/mach4



Scan this QR code with your smartphone and learn more about MACH4.

Accessories.

ER4 external rewinder



- 1 Roll diameter mm: max. 210
- 2 Operating voltage: 100 – 240 V~
- 3 Core diameter mm: 40 / 76

Media hub



Labels and ribbons can be provided in additional holders for quick replacement.

Ribbon holder



Removable battery 4 VDC/7.2 A



Operating voltage: 24 VDC / 7.2 Ah
L x W x H mm: 380 x 185 x 90
Weight: 5.5 kg

Recharger 24 V



Operating voltage: 100 – 240 V~
Charging rate: max. 2 A
Charging time: 6 – 8 h when completely recharged

Connecting cable



Length: 1.5 m
More lengths on request

Connecting plug



For independent cable fabrication
Powercon NAC3FCA

Memory card



CompactFlash Type I
Label formats, fonts, texts and graphics can be saved. Accessible from the printer or from the PC.

Standard keyboard



Connection: USB
No. of keys: 115

Operation and compliance with CE standards is only warranted by using materials provided or recommended by cab.

Software tools.

Direct programming with J-Script

The printer language is easy to understand and simple to integrate into your host system. Variable data is linked with host applications. Label design, graphic data and fonts are recorded on the Compact-Flash card. The host computer sends only variable data to the printer.

```
J
H 100
O R
S I1;0,0,68,70,100
T 10, 10,0,5,pt20;sample
B 10,20,0,EAN-13,SC2,401234512345
G 8,3.5,0;R:30,9,0,3;0,3
A 1
```

Job start
Speed (100 mm/s)
Orientation rotated by 180°
Size of label (100x68 mm, gap 2 mm)
Text object/font: Swiss bold, 20 pt
Barcode EAN 13, size SC 2
Graphic, box 30 x 9 mm,
Line strength 0.3 mm
Number of labels (in this example 1)

Integration into SAP R/3*

In cooperation with SAP, cab developed the "replace method" for controlling cab printers quickly and easily from SAP R/3 using SAPScript. As a Silver Level partner in SAP's Printer Vendor Program, cab has access to the SAP development area for optimum printer support in SAP environments.

* SAP and R/3 are registered trademarks of SAP AG.

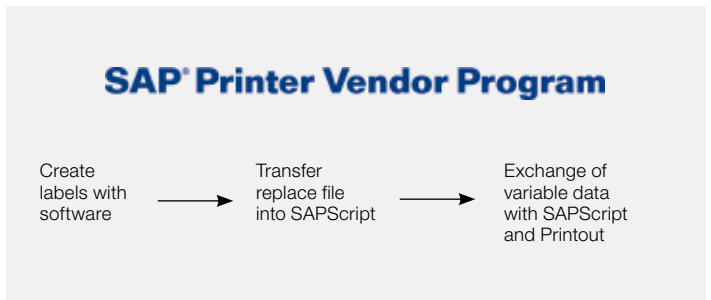

abc – Basic Compiler

As an integrated element of the firmware, the Basic Compiler enables the printer to process data via BASIC programming before it is sent for print editing. This makes it possible for external printer languages to be replaced or data from other systems, e.g. a PLC or balance, to be transferred so information can be printed in different label formats.

Example of use:

Connection to a balance

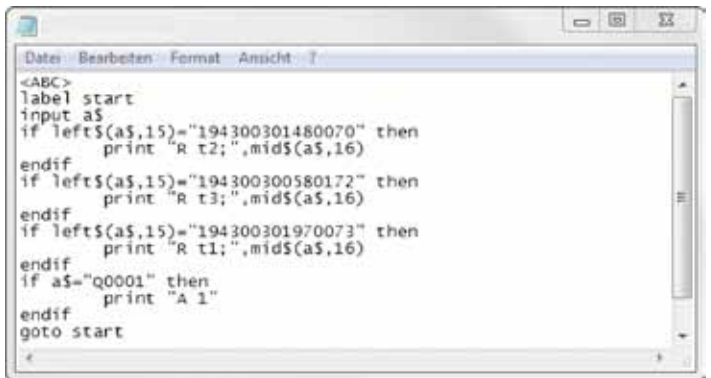

Database Connector

In stand-alone mode with additional network connection, the Database Connector enables stand-alone printers to access data directly from a central SQL-compatible database and to print it as a label. Data can also be written back to the database or changed during the printing process.



Printer monitoring with Intranet and Internet

Using standard programs such as the web browser or FTP clients, the integrated HTTP and FTP server enables print monitoring, configuration, firmware updates and memory card administration. Status, warning and error messages are sent to administrators or users as e-mails or SNMP datagrams via SNMP and SMTP clients. A time server is used to synchronize the time and date.



Administration Network Manager

The cab Network Manager enables the user to control multiple printers across a network simultaneously. It supports monitoring, configuration, firmware updates, memory card administration, file synchronization and PIN administration centrally.

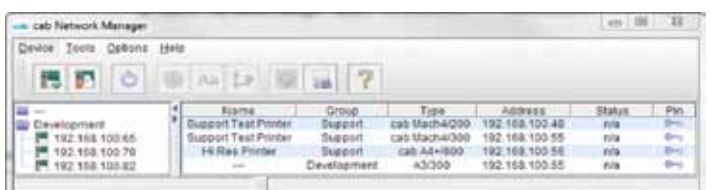

Printer driver.



WHQL-certified Windows printer driver for

Windows XP	Windows Server 2003
Windows Vista	Windows Server 2008
Windows 7	Windows Server 2008 R2
Windows 8	Windows Server 2012

Our printer drivers are officially certified and signed by Microsoft. They ensure optimum stability on your Windows operating system. The programs Word, Excel, Access, Corel Draw, etc. can be used to design and print labels.



Apple-Mac OS X® driver

Alternatively, cab offers a CUPS-based printer driver for Mac OS X.



Linux driver

Alternatively, cab offers a CUPS-based printer driver for Linux.

*Microsoft® is a registered trademark of Microsoft Corporation.
Mac OS® is a registered trademark of Apple Computer, Inc*

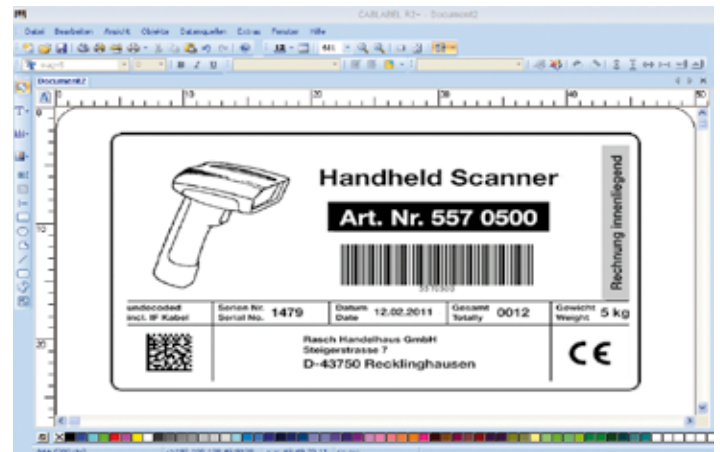
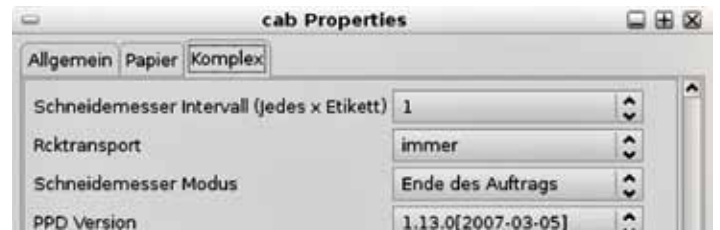
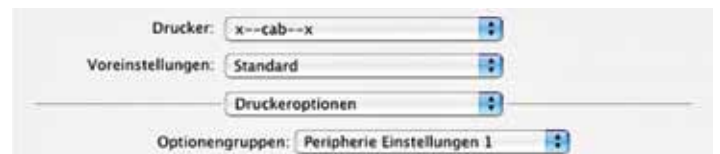

Label software.

cablabel R2+

A powerful label software that is available free of charge and specially designed for cab printers and print & apply systems.

Different fonts, barcodes and graphics in variable heights, widths and printing directions can be used to produce the best possible label design.

In addition to the loadable TrueType fonts available with MS Windows, cab printers also offer a large number of internal bitmap and vector fonts. Thanks to the support of the most commonly used codepages, country-specific special characters can also be printed.

High-performance functions make it possible to design and print even complex labels in just a few minutes. cablabel R2+ supports special functions of the cab printers, such as real-time clock, printer counter, stand-alone operation without PC, circular fonts or the printout of the printer data stream in a file. The MDI technology makes it possible to open several labels at the same time and to move objects from one label to another.









cablabel R2+ is available in 24 different languages for the following operating systems:









Windows XP	Windows Server 2003*
Windows Vista	Windows Server 2008*
Windows 7	* Terminalserver / Citrix are not supported.

Additional label software

Highest possible variability – other commercially available label software solutions, such as Codesoft, Nicelabel, Easylabel, Bartender, Label Matrix or Labelview, support the cab label printers and labeling systems. More information is available on our website.

Delivery program.

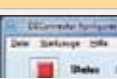
	Part no.	Hardware	dpi
	5541082 5541083 5541086	With tear-off plate Label printer MACH4 / 200B Label printer MACH4 / 300B Label printer MACH4 / 600B	
	5541092 5541093 5541096	With tear-off plate and dispensing function Label printer MACH4 / 200P Label printer MACH4 / 300P Label printer MACH4 / 600P	
	5541102 5541103 5541106	With cutter Label printer MACH4 / 200C Label printer MACH4 / 300C Label printer MACH4 / 600C	
	554xxxx.600	Label printer MACH4 / xxxx -24V	
	5541xxx.102	Label printer MACH4 / xxxx with RFID read/write unit 13.56 MHz	
Scope of delivery			
		Label printer, Power cable type E+F, length 1.8 m, Connecting cable USB, length 1.8 m, Operating manual de/en	
DVD:		Quick Start guide in 17 languages, Operating manual de/en/fr, Configuration manual de/en/fr, Service manual de/en, Spare parts list de/en, Programming manual en, Windows printer driver 32/64 bit in 19 languages for Windows XP Server 2003 Windows Vista Server 2008 Windows 7 Server 2008 R Windows 8 Server 2012 Label software cablabel R2+ in 24 languages, Database Connector en, Mac OS X driver de/en/fr, Linux driver de/en/fr	
	Part no.	Spare parts	
	5541074.001 5541073.001 5541077.001	Printhead 4 / 203 Printhead 4 / 300 Printhead 4 / 600	
	5540896.001	Print roller DR4	
	Part no.	Accessories	
	5540750	External rewinder ER4 / 210	
	5540867.001	Media hub	

	Part no.	Accessories
	5540866.001	Ribbon holder
	5541219	Removable battery 24 VDC / 7.2 A
	5541221	Recharger 24 V
	5541222	Connecting cable 24 V length 1.5 m
	5917904	Connecting plug
	On request	Standard PC keyboard USB German version
	5561043	Memory card CompactFlash Type I
	Part no.	Interfaces
	5954200 5954201	Centronics interface RS422/RS485 interface
	5954191	Label selection – I/O box
	5561041	WLAN card 802.11 b/g
	Part no.	Connecting cable
	5550818	Cable RS232 C 9/9 pin, length 3 m
	5918008	Patch cable KAT 5e, 3 m gray
	Part no.	Software
	DL 40100	Database Connector license
	5580215	Administration Network Manager
	Scope of delivery	Label software cablabel R2+
	On request	Codesoft, NiceLabel, Easylabel
	9008486	Programming manual english, printed copy

The cab delivery program

Label printer EOS1
The compact for
label rolls up to 155 mm Ø



Label printer EOS4
The cost-effective for
label rolls up to 210 mm Ø



Label printer MACH4
The versatile
for a smooth workflow



Label printer A+ series
The universal



Label printer A+M
with centered material guide



Label printer XD4
double-sided printing



Textile printer A+T
For textile material



Label printer XD4T
double-sided printing of
textile material



Label printer XC4
two-color printing



Label printer XC6
two-color printing



Label dispenser HS
Precise and easy dispensing in
horizontal direction
up to a width of 180 mm



Label dispenser HS
Precise and easy dispensing in
vertical direction
up to a width of 180 mm



Print & apply system Hermes+
for automation



Print module PX series
for integration into automatic
labeling systems



Labels / Transfer ribbons
precise printing with cab's
labels and transfer ribbons



Label software
standard and optional software



Laser product marking FL series
precise and fast



Laser safety housing
The industrial solution



- Headquarter in Germany
- cab subsidiaries
350 distribution partners
in more than 80 countries.

cab is represented in every active
commercial center - worldwide.

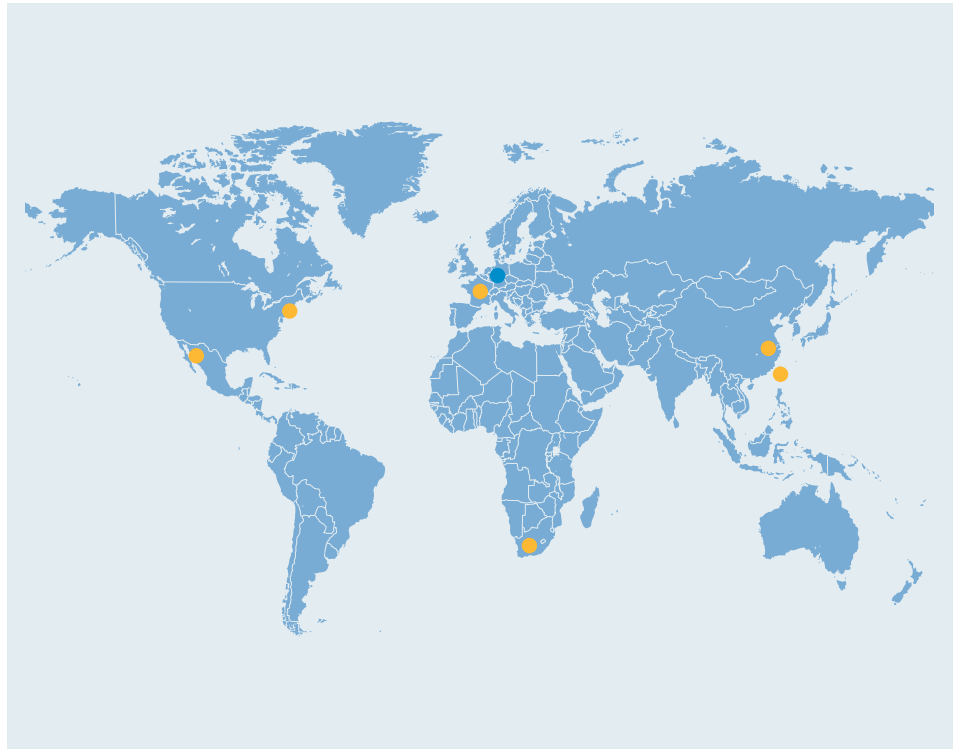

For current data, please go to www.cab.de

Germany

cab Produkttechnik
GmbH & Co KG
Postfach 1904
76007 Karlsruhe
Wilhelm-Schickard-Str. 14
76131 Karlsruhe
Telefon +49 721 6626-0
Telefax +49 721 6626-249
www.cab.de
info@cab.de

[Representatives in other
countries on request.](#)

France

cab technologies s.a.r.l.
67350 Niedermodern
Téléphone +33 388 722 501
www.cab.de/fr
info.fr@cab.de

USA

cab Technology Inc.
Tyngsboro MA, 01879
Phone +1 978 649 0293
www.cab.de/us
info.us@cab.de

South Africa

cab Technology (Pty.) Ltd.
2125 Randburg
Phone +27 11-886-3580
www.cab.de/za
info.za@cab.de

Asia 亚洲

cab Technology Co, Ltd.
希爱比科技股份有限公司
Junghe, Taipei, Taiwan
Phone +886 2 8227 3966
www.cab.de/tw
info.asia@cab.de

China 中国

cab (Shanghai) Trading Co., Ltd
铠博(上海)贸易有限公司
Phone +86 21 6236-3161
www.cab.de/cn
info.cn@cab.de

This documentation and any translations hereof are the property of cab GmbH & Co KG.

The replication, processing, reproduction or distribution in whole or in parts requires our prior written consent. © Copyright by cab/9008458.

All delivery, design and technical specifications are compiled to the best of our current knowledge and are subject to change without prior notice.