

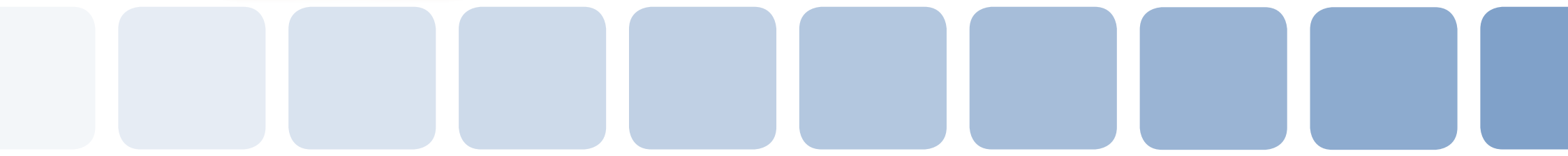

# VENUSmini<sup>®</sup>

MINIMALLY INVASIVE FIXATION SYSTEM





The VENUSmini pedicle screw fixation system allows minimally invasive, percutaneous correction and stabilisation of the spine and is the logical further development of the innovative design properties of the standard screw system. It facilitates accurate positioning of the pedicle screws. The screw head holders are fixed to the screw heads and thus permit uncomplicated, safe guidance during implantation. The rod inserter provides full control and reliable insertion of the rod into the correct position.

Simple compression, distraction and reduction/reposition expand the variability and intraoperative flexibility.

The instrumentarium is extremely clearly arranged and ergonomic comprised of consistently MIS-adapted, cannulated instruments that allow the insertion of the implants through a very small incision, guided by K-wires and special instruments for percutaneous applications.

This allows the surgeon to dissect the area safely and atraumatically, and provides efficient and stable guidance of the instrumentation, protecting the ligaments and muscles.

#### Safe

- Safe positioning of the rods through the guidance holes in the head holders
- Extensive options for reposition without enlargement of the incision
- Integrated reposition thread for easy manoeuvring of the rod

#### Anatomical

- Minimal muscle trauma due to true percutaneous technique
- Self-tapping threads without traumatising cutting flutes

#### Transparent

- Colour-coded screws
- Clearly arranged and simple instrumentarium

#### Stable

- Load-optimised screw shaft design
- Extension and rod holder are designed in such a way that they can withstand the forces required to correct deformities

#### Flexibel

- Versatile application and techniques
- Large selection of implants
- Different spinal segments
- Optimum adaptability to anatomy
- Can be combined with all VENUS® implants
- Numerous rod options for different lengths





Minimally-Invasive Fixation System

# VENUSmini

## Product-Specific Advantages

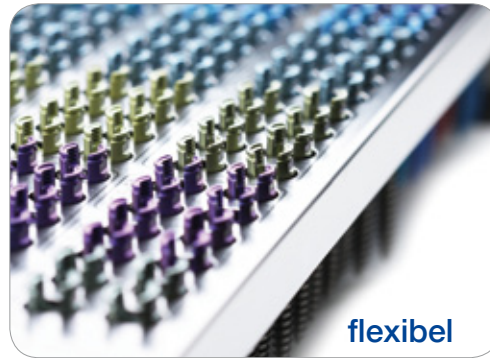
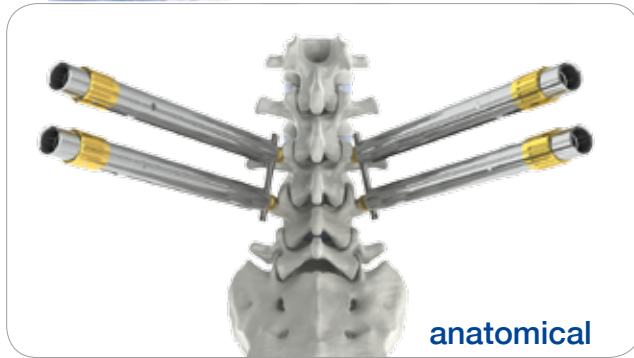

1. anatomical
2. transparent
3. stable
4. flexibel
5. safe

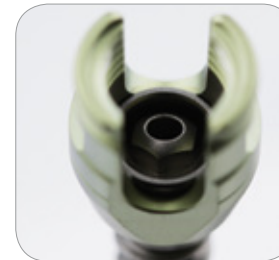
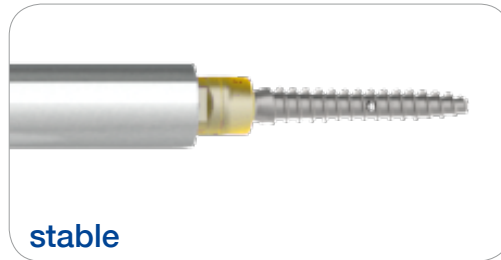
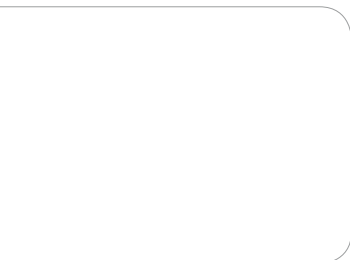



### Preparing the pedicle using the Cannulated Awl

A longitudinal incision of approx. 2.5 cm in length is made through the skin and fascia. The Cannulated Awl / Cannulated Awl without Stop is inserted into the incision until the tip rests on the bony anatomy of the target segment. Pedicle entrance point is penetrated with light blows of a hammer. In the case of the Cannulated Awl, the tip of the awl should be driven in all the way, while in the case of the Cannulated Awl without Stop, the tip of the awl should be at a depth of about 25 mm in the pedicle. The Trocar Wire is removed once the awl is positioned securely in the pedicle.

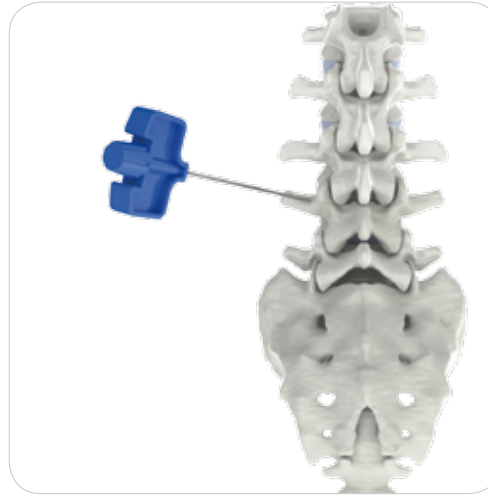

### Preparing the pedicle using a Jamshidi Needle

A longitudinal incision of approx. 2.5 cm in length is made through the skin and fascia. The Jamshidi Needle is inserted into the incision until the tip rests on the bony anatomy of the target segment. It is advanced to the pedicle at the junction of the facet to the transverse process. The tip of the needle should be located at the centre of the lateral margin of the pedicle on the AP X-ray image. The needle is hammered in lightly so that the trocar tip is fixed in the pedicle. This should be driven through the pedicle no more than  $\frac{3}{4}$  of the distance from the margin of the pedicle. It is then further advanced until it penetrates the vertebral body. The internal obturator is withdrawn from the needle.

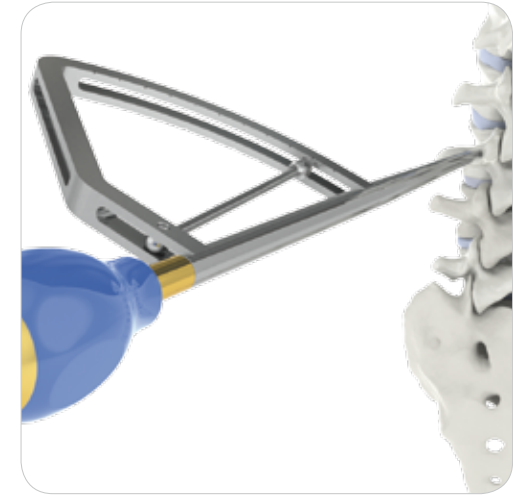

### Preparing the pedicle using a Goniometer Awl

A longitudinal incision of approx. 2.5 cm in length is made through the skin and fascia. The Goniometer Awl is inserted into the incision until the tip rests on the bony anatomy of the target segment. The MRI section images form the basis for the insertion angle. Setting the angle that has been measured on the Goniometer Awl is accomplished through tilting the awl laterally. The desired angle is shown on the dial at the tip of the pendulum. Penetrate the pedicle entrance point with light blows of a hammer. The tip of the awl should be at a depth of about 25 mm in the pedicle. The trocar wire is removed once the awl is positioned securely in the pedicle.

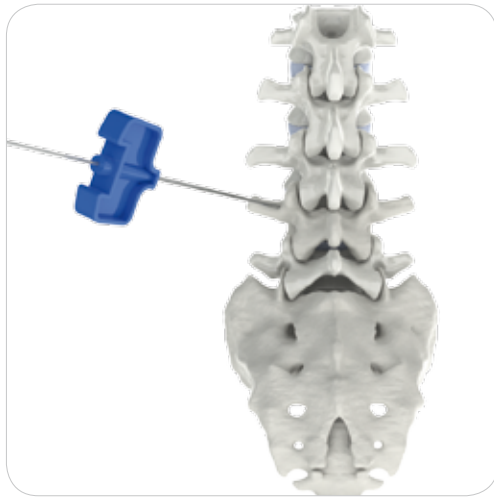

### Positioning the guide wire when using a Jamshidi Needle

The guide wire is inserted into the Jamshidi Needle and advanced through the tip of the Jamshidi needle (by approx. 20 mm), to ensure adequate fixing in the spongiosa. The Jamshidi needle is carefully removed once the guide wire has been positioned at the desired depth; during this process, the guide wire is held firmly in place.

Comment:

As a rule, **all** guide wires should be positioned before insertion of the pedicle screws. Care must be taken to ensure the correct direction of the guide wires when inserting them. The position markings affixed on the guide wire should point in the distal direction. This is also the case when using the Cannulated Awl / Cannulated Awl without Stop or the Goniometer Awl.



### Inserting the Pedicle Marker (optional)

The Pedicle Marker is advanced into the pedicle over the guide wire. Using this is optional and it serves on one hand to accurately align the implant screws and to define the depth of the pre-prepared screw channel on the other. The tip of the Pedicle Marker should be located at the centre of the lateral margin of the pedicle on the AP X-ray image.

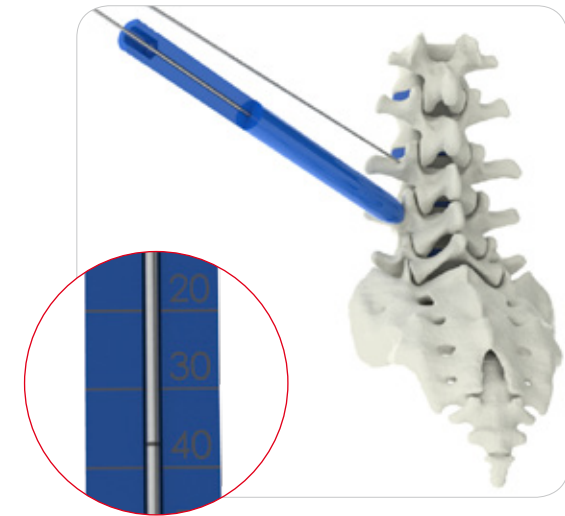

### Inserting the Tissue Dilator and determining the screw length

In order to gently expand the tissue, the Tissue Dilator is advanced over the guide wire until its tip touches the pedicle. On the dial of the dilator, the screw length to be used can be read using the penetration depth of the guide wire.

Caution:

Following this, the screw length must be examined using X-ray imaging.





### Remove the Tissue Dilator and insertion of the Protective Sleeve (optional)

Remove the Tissue Dilator while holding the guide wire firmly in place.

Optional for tap:  
Insert the Protective Sleeve via the guide wire.



### Tapping (optional)

The appropriate cannulated tap is screwed into the pedicle over the guide wire and through the Protective Sleeve. At the same time, the sleeve is checked constantly. Ensure that the guide wire is not inadvertently pushed forward or twisted by mistake during tapping.

The tap is only advanced forward as far as the tip of the guide wire. On removal of the tap, it is to be ensured that the guide wire is not removed.



### Loading the screws

Selection of the type of screw with the right length and diameter. Slide the Head Holder over the head of the screw and turn it until the notch for the Rod Holder on the screw head is aligned with the holes of the Head Holder and the retaining ring of the Head Holder is screwed onto the ring nut of the screw head. Lock the connection between the instrument and the implant by turning the fixing screw which is located in the upper region of the Head Holder. Check to ensure the screw head is solidly anchored in the Head Holder. While working with the Head Holder, it must be ensured that the fixing screw is not loosened.



### Pre-assembly of the MIS Polyaxial Screw Driver

Insert the MIS Polyaxial Screw Driver in the loaded Head Holder. Fix the MIS polyaxial screw driver using the connecting screw which is located at the back end. Check that the screw is fixed.

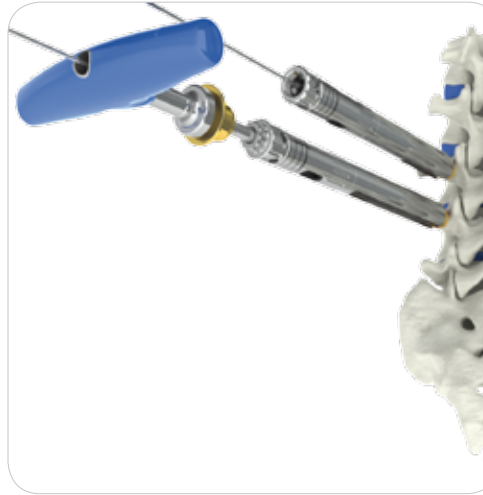

### Inserting the screw

Guide the construction made up of the screw, Head Holder and Polyaxial Screw Driver along the guide wire to the pedicle. Screw the polyaxial screw into the pedicle while checking the image converter. Remove the guide wire and as soon as the screw has penetrated through the pedicle into the vertebral body and is in its final position. To guarantee its continued full polyaxial nature, ensure that the screw head is not in direct contact with the bone.

Remove the Polyaxial Screw Driver by loosening the connecting screw. Align the Head Holder such that the hole is in line with the holes in the Head Holder on the next segment. Here the long holes must point in the direction in which the rod is to be inserted.



### Selecting the rod length

The selected length of the rod can be determined using the distance between the Head Holders as an aid. During this process, the marking on the rod must at minimum be positioned level with the external wall of the Head Holder, such that the rod's instrument holder and the front insertion tip lie outside the Head Holder.

Check the selected rod length on the image converter to ensure that the both ends of the rod protrude from the Head Holders by at least 5 mm.

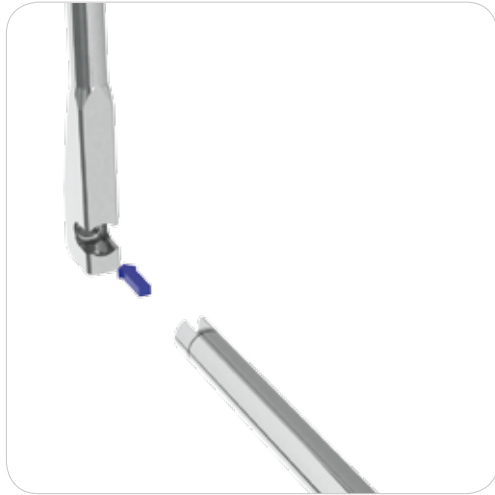

### Rod Holder assembly I

Insert the selected rod into the Rod Holder. During this, ensure that the locking pin for the rod is screwed upwards. The rod is guided into the Rod Holder with the pre-assembled instrument holder so the locking pin can latch into it.



### Rod Holder assembly II

The rod is fixed in the holder using the screw mechanism with the help of the Locking Screw Driver.



### Rod Holder assembly III

Only tighten the locking screw softly by hand with the help of the Locking Screw Driver, as otherwise deformations or damage to the instrument can result.





### Inserting the rod

Position the Rod Holder vertically next to the Head Holder so that the tip of the rod is pointing downwards. Insert the rod in a vertical position to below the fascia. Direct and guide the rod into the Head Holder in the next segment by raising the Rod Holder. The Rod Holder must be parallel to the Head Holder once it is in its final position. During this process, ensure that the rod is guided between the muscles thus avoiding any trauma.

Check on correct positioning of the rod using the image converter. While doing this, also make sure that the end of the rod protrudes by at least 5 mm over the head of the screw both proximally and distally.



### Fitting the Set Screw onto the Set Screw Inserter

Fit the set screw onto the Torx of the Set Screw Inserter. Fix the Set Screw using the threaded rod in the instrument.

**Caution:**  
Only tighten the threaded rod by hand, as otherwise complications can arise when loosening the Set Screw afterwards.



### Inserting the Set Screw Inserter

The Set Screw inserter is guided into the Head Holder with the fitted Set Screw until it sits on the rod.



### Fitting and tightening the Adapter Screw

The Adapter Screw is guided over the Set Screw Inserter to the Head Holder and tightened.



### Fitting the Rod Pusher Handle

The Rod Pusher Handle is guided over the Set Screw Inserter to the Adapter Screw. Combined with the Set Screw Inserter, the Adapter Screw pushes the rod down into the implant screw head.

Push the Rod Pusher Handle down and tighten it. During this, do not exceed the bottom-most marking line on the Head Holder as otherwise, the Set Screw will be pushed into the thread of the implant screw.



### Tightening the Set Screw

After positioning the rod in the implant screw, the Set Screw is then screwed into the head of the implant screw.

Caution:

Only tighten the set screw lightly, the final torque is carried out by Set Screw Driver.

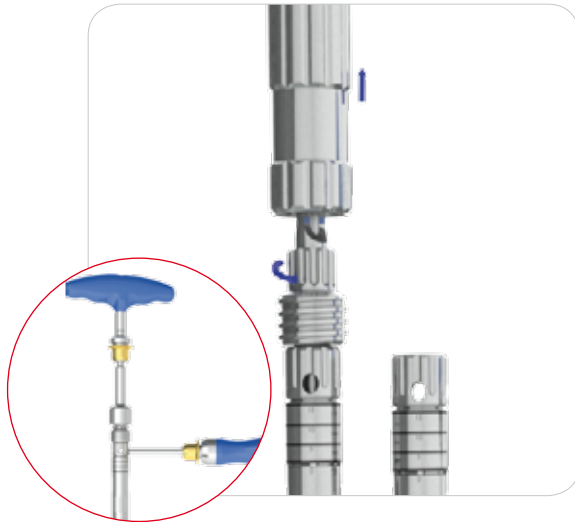

### Removing the Rod Pusher Handle and the Adapter Screw

The handle screw is removed first, followed by the Adapter Screw.

Comment:

Sometimes the Adapter Screw can be fitted too tightly to be loosened by hand. In this case, first remove the Set Screw Inserter as described in the following step and then use the MIS Key and the MIS Release Shaft.



### Removing the Set Screw Inserter

To remove the Set Screw Inserter, the threaded rod must first be loosened by turning. Then the Set Screw Inserter can be taken out.

Comment:

This procedure is repeated for each implant screw.



### Removing the Rod Holder

A final check on the correct positioning of the rods should be made before the Rod Holder is removed. The ends of the rods should protrude at least 5 mm over every screw head both proximally and distally and they should be fixed correctly in the screw head. Loosen the Rod Holder with the help of the Locking Screw Driver. Here, it should be ensured that the Locking Screw Driver is clearly snapped into place in the screw mechanism. Then manoeuvre the Rod Holder out of the Head Holder in the caudal - dorsal - cranial - dorsal direction. Repeat the step for the second rod.

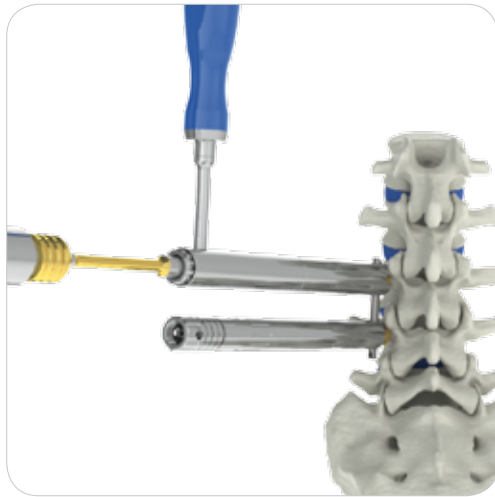

### Final tightening of the Set Screw

Final tightening of the Set Screw  
The Counter Holder is slid over the Head Holder and pushed all the way onto the rod. Using a gentle back and forth movement, ensure that the notches of the Counter Holder are locked onto the rod. Couple the MIS Set Screw Driver and the Torque Wrench. Insert the combi-instrument in the Head Holder opening. Tighten the set screw in a clockwise direction. Same approach for all other Set Screws.

Comment:

The full torque of 12 Nm is reached when an acoustic signal is heard.



### Removing the Head Holder

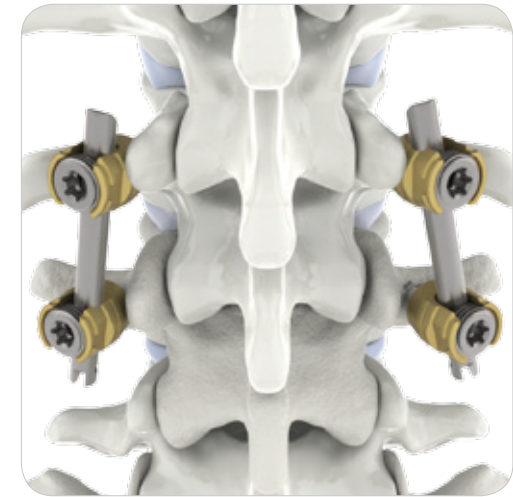

A final check on correct positioning of the fixing mechanism should be made using the image converter before the Head Holders are removed. Unbolt the Head Holder by turning the locking sleeve that is located in the upper region of the Head Holder. Release the Head Holder from the screw head by turning it gently.



### Finale construction

Final check on the construction with X-ray control images taken in two planes. Cleanse the surgical area and wound closure.



Art.No.	Description	Image
1006044825	Cannulated Polyaxial Screw Ø 4.8 mm x 25 mm	
1006044830	Cannulated Polyaxial Screw Ø 4.8 mm x 30 mm	
1006044835	Cannulated Polyaxial Screw Ø 4.8 mm x 35 mm	
1006044840	Cannulated Polyaxial Screw Ø 4.8 mm x 40 mm	
1006045525	Cannulated Polyaxial Screw Ø 5.5 mm x 25 mm	
1006045530	Cannulated Polyaxial Screw Ø 5.5 mm x 30 mm	
1006045535	Cannulated Polyaxial Screw Ø 5.5 mm x 35 mm	
1006045540	Cannulated Polyaxial Screw Ø 5.5 mm x 40 mm	
1006045545	Cannulated Polyaxial Screw Ø 5.5 mm x 45 mm	
1006045550	Cannulated Polyaxial Screw Ø 5.5 mm x 50 mm	
1006045555	Cannulated Polyaxial Screw Ø 5.5 mm x 55 mm	
1006046530	Cannulated Polyaxial Screw Ø 6.5 mm x 30 mm	
1006046535	Cannulated Polyaxial Screw Ø 6.5 mm x 35 mm	
1006046540	Cannulated Polyaxial Screw Ø 6.5 mm x 40 mm	
1006046545	Cannulated Polyaxial Screw Ø 6.5 mm x 45 mm	
1006046550	Cannulated Polyaxial Screw Ø 6.5 mm x 50 mm	
1006046555	Cannulated Polyaxial Screw Ø 6.5 mm x 55 mm	

Art.No.	Description	Image
1006047235	Cannulated Polyaxial Screw Ø 7,2 mm x 35 mm	
1006047240	Cannulated Polyaxial Screw Ø 7,2 mm x 40 mm	
1006047245	Cannulated Polyaxial Screw Ø 7,2 mm x 45 mm	
1006047250	Cannulated Polyaxial Screw Ø 7,2 mm x 50 mm	
1006047255	Cannulated Polyaxial Screw Ø 7,2 mm x 55 mm	
1006047260	Cannulated Polyaxial Screw Ø 7,2 mm x 60 mm	













Art.No.	Description	Image
VL-PMS-M3	MIS-Setscrew	









Art.No.	Description	Image
VL-RM-5-40	Rod Mini Ø 5.5 mm x 40 mm	
VL-RM-5-50	Rod Mini Ø 5.5 mm x 50 mm	
VL-RM-5-60	Rod Mini Ø 5.5 mm x 60 mm	
VL-RM-5-70	Rod Mini Ø 5.5 mm x 70 mm	
VL-RM-5-80	Rod Mini Ø 5.5 mm x 80 mm	
VL-RM-5-90	Rod Mini Ø 5.5 mm x 90 mm	
VL-RM-5-100	Rod Mini Ø 5.5 mm x 100 mm	
VL-RM-5-110	Rod Mini Ø 5.5 mm x 110 mm	







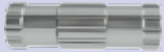

Art.No.	Description	Image
VL-RMC-5-40	Rod Mini Curved Ø 5.5 mm x 40 mm	
VL-RMC-5-50	Rod Mini Curved Ø 5.5 mm x 50 mm	
VL-RMC-5-60	Rod Mini Curved Ø 5.5 mm x 60 mm	
VL-RMC-5-70	Rod Mini Curved Ø 5.5 mm x 70 mm	
VL-RMC-5-80	Rod Mini Curved Ø 5.5 mm x 80 mm	
VL-RMC-5-90	Rod Mini Curved Ø 5.5 mm x 90 mm	
VL-RMC-5-100	Rod Mini Curved Ø 5.5 mm x 100 mm	
VL-RMC-5-110	Rod Mini Curved Ø 5.5 mm x 110 mm	

Art.No.	Description	Image
1008010002	MIS Tissue Dilator	
1008010001	MIS Protective Sleeve	
33.2517.400	K-Wire Ø 1,7 x 400 mm rund	
33.2517.480	K-Wire Ø 1,7 x 480 mm rund	
1008010005	MIS Rod Pusher	
1008010006	MIS Counter Holder	
1008010007	MIS Shaft Cannulated Polyaxial Screw Driver	
1006010600	T-Handle Cannulated	
1006010900	Handle Straight Cannulated	

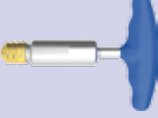



Art.No.	Description	Image
1008010008	MIS Rod Holder	
1008010010	MIS Head Holder	
1008010014	MIS Set Screw Driver	
BMHN 1104 VX	MIS Jamshidi Needle	
1008010013	MIS Pedicle Marker	
1008010019	MIS Release Shaft	
1008010018	MIS Key	
1008010017	MIS Pusher Handle	
1008010016	MIS Adapter Screw	

Art.No.	Description	Image
1008010015	MIS Set Screw Inserter	
1006011100	Cannulated Awl	
1006011101	Cannulated Awl without Stop	
1101010001	HERO Locking Screw Driver	
I-25	Torque Driver - 12	
1006011200	Cannulated Tap 5,5	
1006011201	Cannulated Tap 6,5	
1006011202	Cannulated Tap 7,2	
1006011201	Rod Bender	
1006011202	Rod Inserter	
1006020601	Cementadapter Inserter	
1006020602	Cementadapter Extractor	

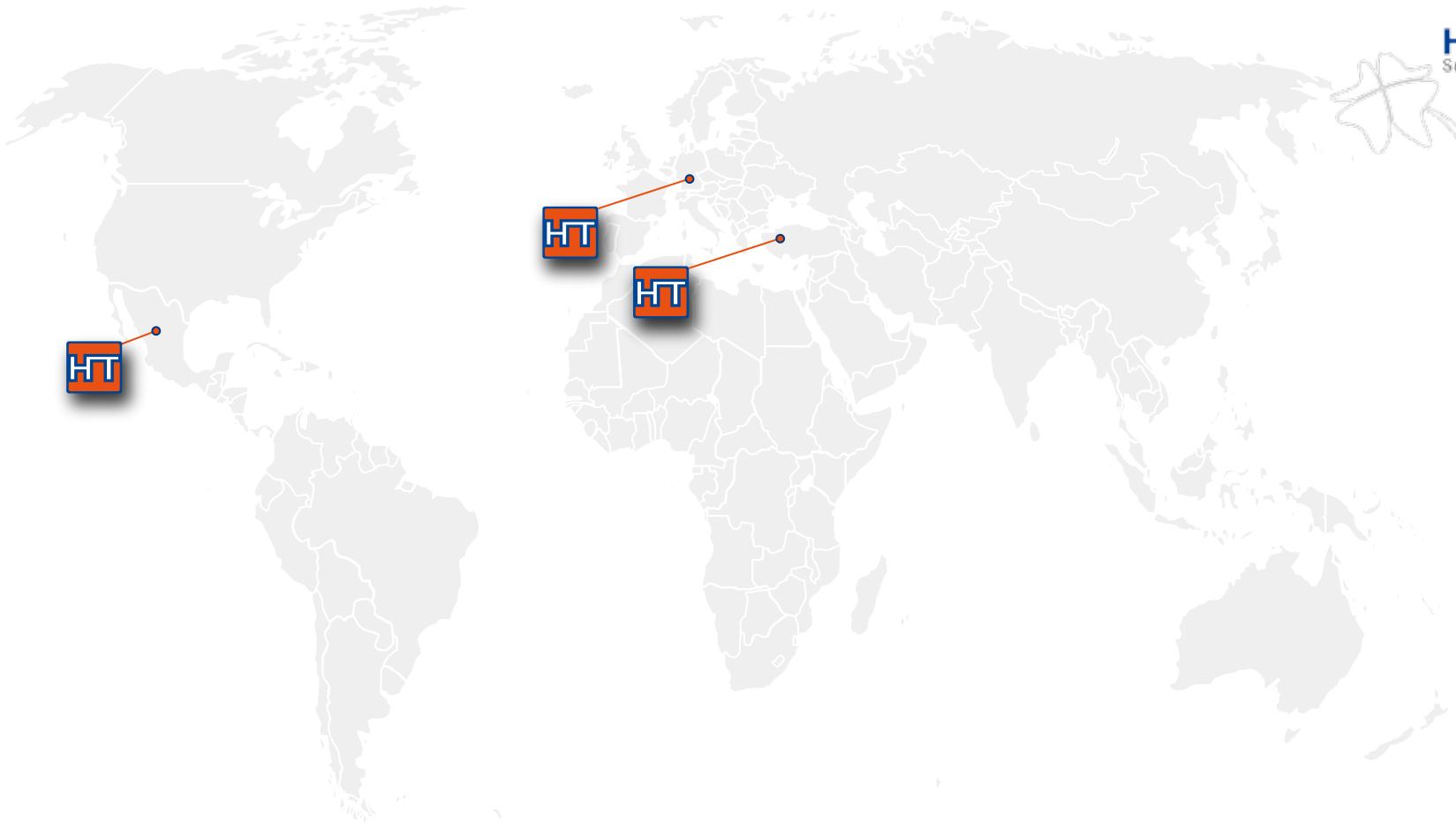

### Manufacturing and Sales Europa

HumanTech Germany GmbH

Gewerbestr. 5  
D-71144 Steinenbronn

Germany

Phone: +49 (0) 7157/5246-71  
Fax: +49 (0) 7157/5246-33  
info@humantech-solutions.de  
www.humantech-solutions.de

### Sales Middle East

HumanTech Med. Sag. Tic. Ltd.

İkitelli OSB Tümsan 2. Kısım  
C-Blok No: 47  
TR-34306 Başakşehir İstanbul

Turkey

Phone: +90 (0) 212/485 6675  
Fax: +90 (0) 212/485 6674  
info@humantech.com.tr  
www.humantech-solutions.de

### Sales Latin Amerika

HumanTech Mexico, S. DE R.L. DE C.V.

Rio Mixcoac No. 212-3  
Acacias del Valle  
Del. Benito Juárez  
C.P. 03240 Mexico, D.F.  
Mexico

Phone: +52 (0) 55/5534 5645  
Fax: +52 (0) 55/5534 4929  
info@humantech-solutions.mx  
www.humantech-solutions.de

### Others

HumanTech Germany GmbH

Gewerbestr. 5  
D-71144 Steinenbronn

Germany

Phone: +49 (0) 7157/5246-71  
Fax: +49 (0) 7157/5246-33  
info@humantech-solutions.de  
www.humantech-solutions.de

