

# SA1E

## Miniature Photoelectric Switches (Built-in Amplifier Type)

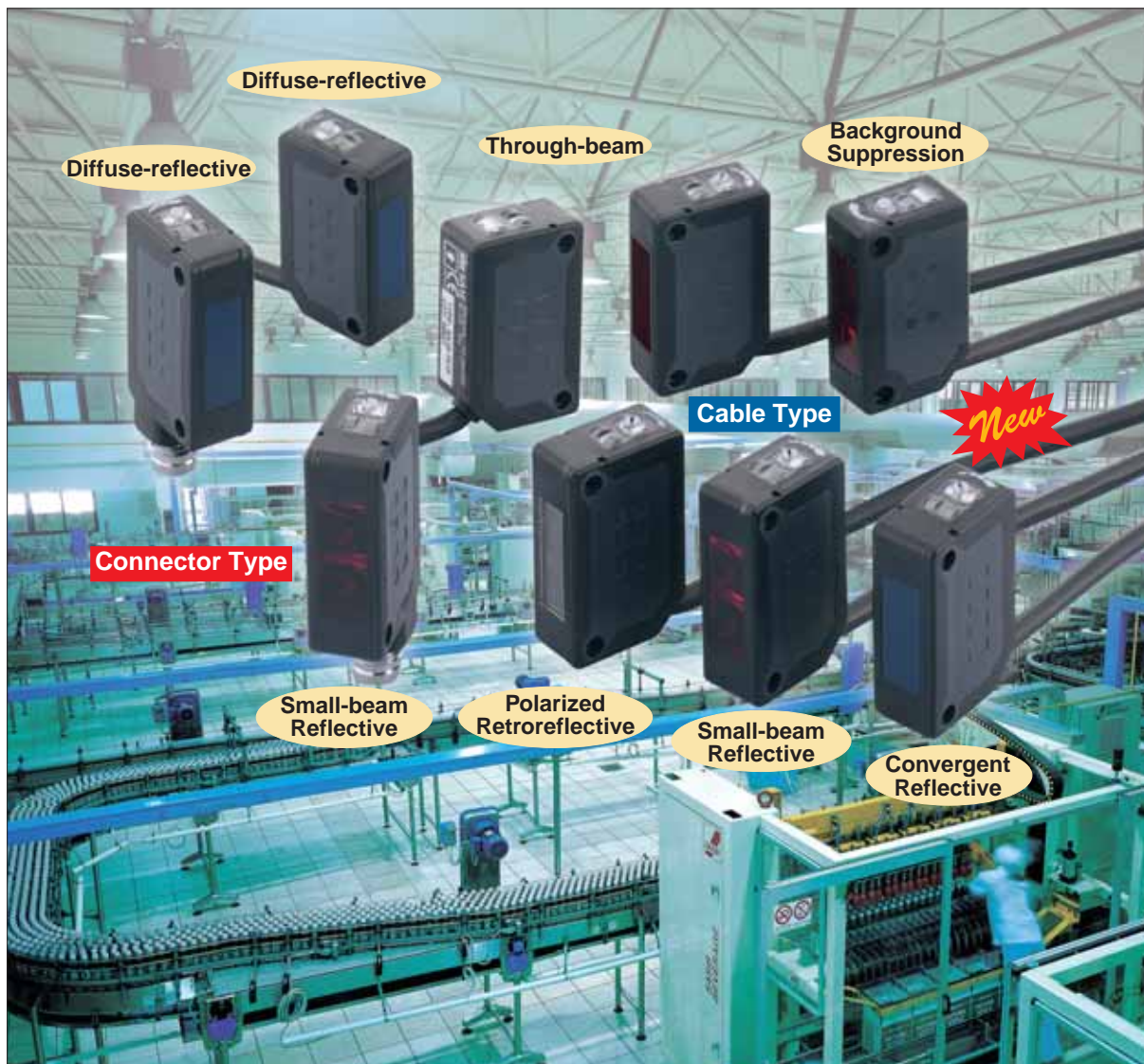

# SA1E

Miniature  
Photoelectric  
Switches

## A wide variety for material



**1** Applicable  
for Hosedown  
Requirements

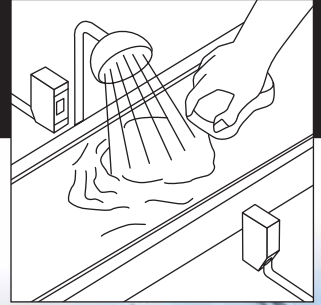

**New** Tape Type Reflector  
IAC-RS2 (80 x 70mm)

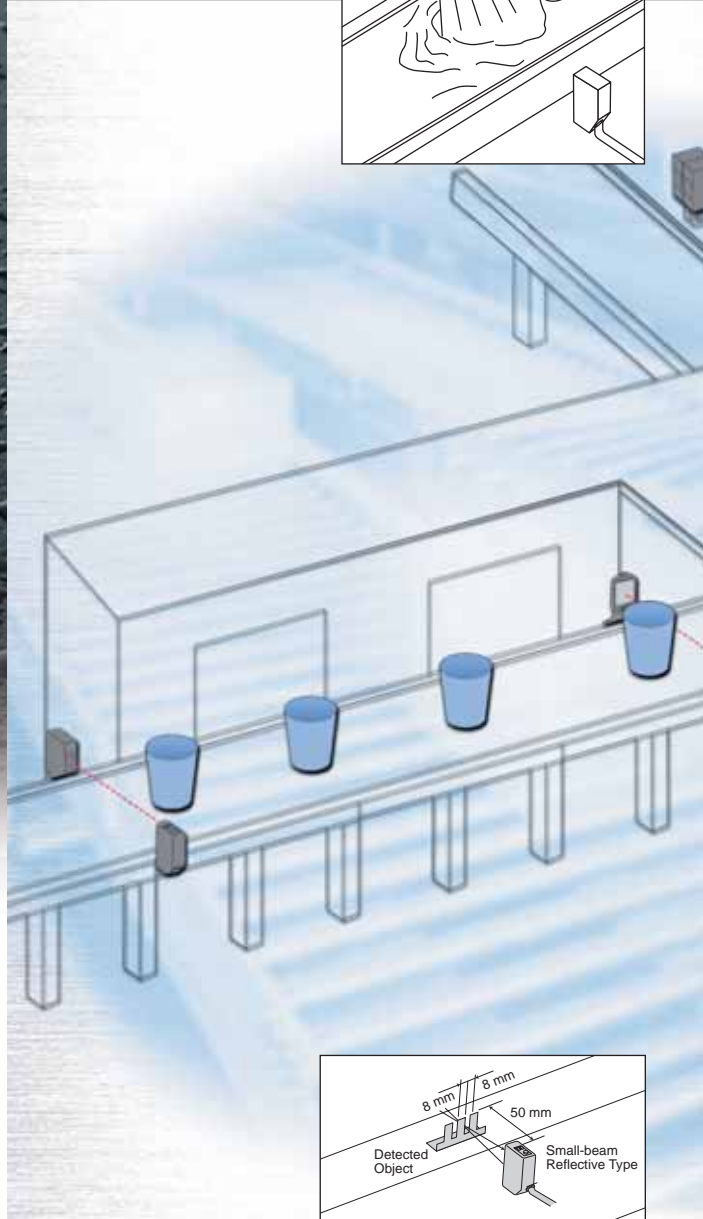

**3** Wide  
Variety

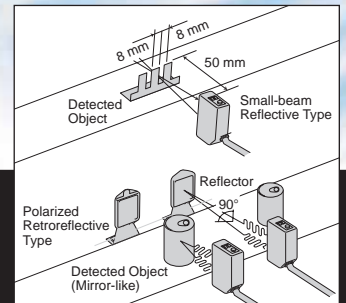

## SA1E Sensing Methods



Background Suppression

- **Through-beam**  
(with/without sensitivity adjustment)
- **Polarized Retroreflective**  
(with/without sensitivity adjustment)
- **Diffuse-reflective**  
(with sensitivity adjustment)

# of global advantages handling and manufacturing!

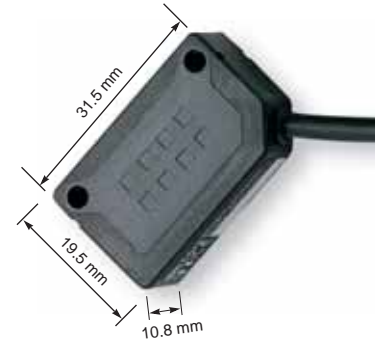

## 2 Superior Interference Prevention

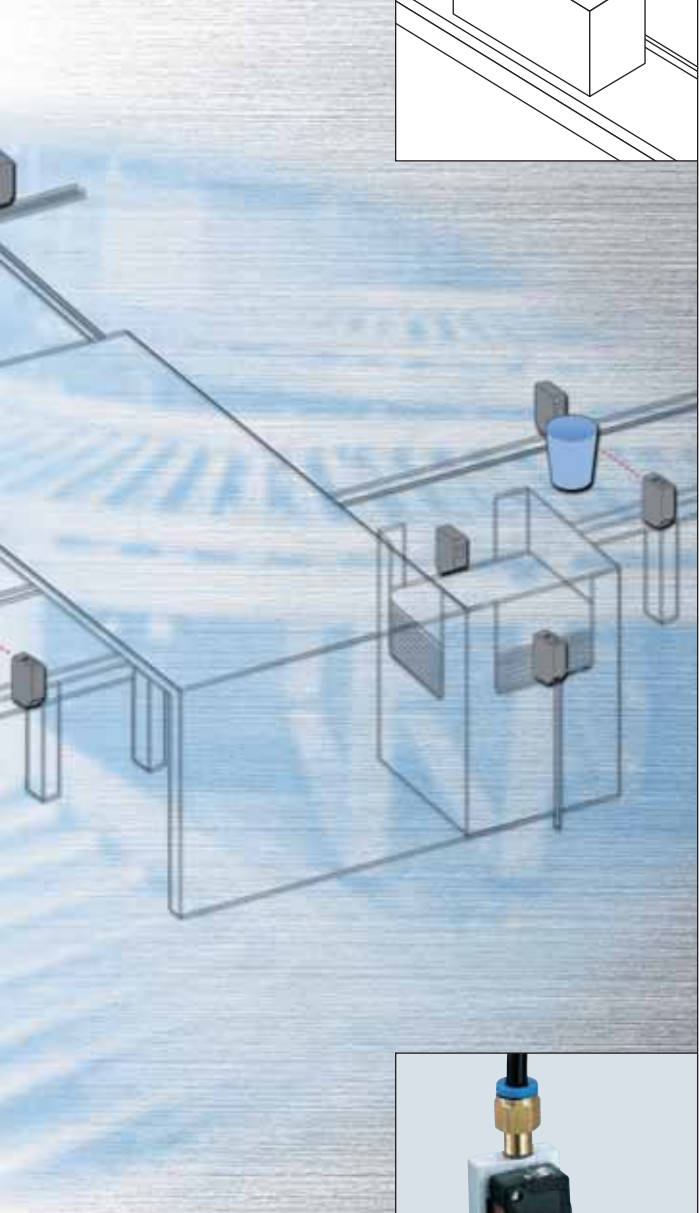
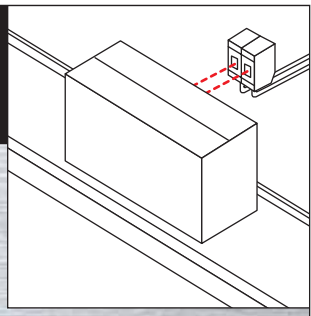

## 4 Accessories



- **Small-beam Reflective**  
(with sensitivity adjustment)
- **Background Suppression**  
(with sensing range adjustment)
- **Convergent Reflective**  
(with sensitivity adjustment)



## 1 Hosedown, IP67 protection

The waterproof, integral molding structure is ideal for food processing and other applications that require frequent water hosedowns. The mounting brackets are made of rust-free stainless steel.

## 2 Superior interference prevention

Because two switches can be mounted closely (except for the through-beam type), moving direction of objects can be detected within a narrow space. Outputs from two sensors can be ANDed together easily.

## 3 Simple design, wide variety

- Choice of light ON or dark ON models
- Units without sensitivity adjustment control available (through-beam type, polarized retroreflective type)
- Red LED type available for easy alignment in long distance applications (through-beam type, polarized retroreflective type, small-beam reflective type, BGS type)
- Two connection methods:  
Cable: 1, 2, and 5m  
Connector: Straight and right angle (2- or 5-m connector cables)
- Available in six sensing versions:
  - Through-beam type:**  
Ideal for long distance detection (with sensitivity adjustment: 10m, without sensitivity adjustment: 15m)
  - Diffuse-reflective type** (sensing range: 700 mm with white mat paper): Can detect light-reflecting transparent objects
  - Polarized retroreflective type** (sensing range: 2.5 m with sensing adjustment, 3.0 m without sensing adjustment):  
Mirror-like objects can also be detected.
  - Small-beam reflective type:**  
Ideal for detecting small objects with red LED beam (50 to 150 mm)
  - Background suppression type (BGS)**  
(sensing range: 20 mm to preset distance)  
(adjustable sensing range: 40 to 200 mm)  
Ideal for detecting objects with a background
  - Convergent reflective type** (sensing range: 5 to 35 mm):  
Detects objects at a short distance ignoring the background.



## 4 Accessories

- **Slits for through-beam type**  
A total of 9 types: 3 slit shapes (vertical, horizontal, and round) and 3 slit sizes
- **Reflectors for polarized retroreflective type**  
6 types in 8 styles. Standard, large, small, narrow-shaped, and tape types are available. Narrow-shaped reflectors do not have exposed mounting holes, preventing dust build-up. The mounting hole layout of narrow-shaped side mounting types are the same as SA1E photoelectric switches.
- **Mounting brackets**  
Vertical, horizontal, and protective cover types are available. Protective cover type is used for protecting the sensor from damages.
- **Air blower mounting block**  
Used for installing an air blower to keep the detection surface clean.





Detects object.



Ignores background.

### Sensing Range

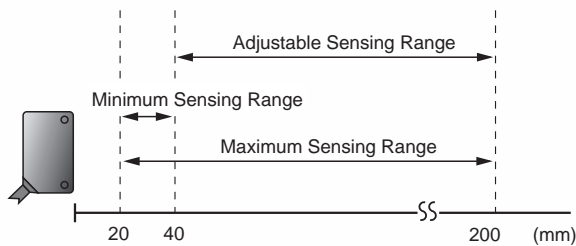

The sensing range can be adjusted using the control knob on the housing.

### Principle of the BGS Type

The principle of triangulation is utilized.

The position of a light-receiving spot depends on the distance between the photoelectric switch and the object. The receiving element consists of dual-element photodiode. ON/OFF status is determined by comparing the amount of light received by the photo diodes (A>B: ON, A<B: OFF).

By adjusting the sensing range, the background suppression sensor ignores the background of the object, such as conveyors.

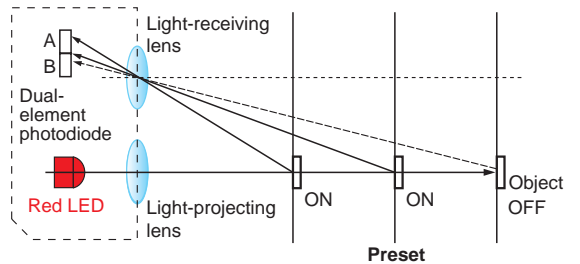

Sensing range can be set by moving the light-receiving lens vertically using the control knob. The light-receiving spot moves along with the light receiving lens. Slide up the light-receiving lens for longer sensing range, and slide down for a shorter sensing range.

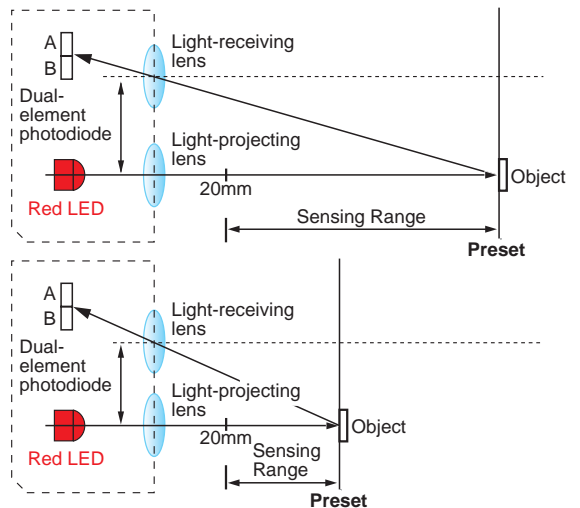

### Comparison

#### Background Suppression (BGS) Type

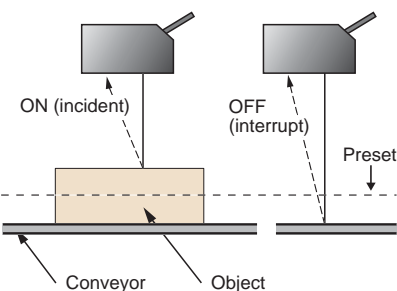

#### Diffuse-reflective Type

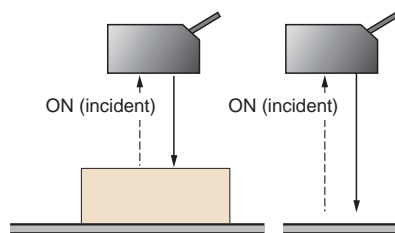

Because a photoelectric switch of diffused reflective type determines ON/OFF status with the amount of light, the switch may turn ON by detecting the background, such as a conveyor.

The background suppression type depends on the distance to determine ON/OFF status and therefore detects the object only, ignoring the background.

setting the sensing distance. Only objects are detected.

## Application Examples

### Background Suppression Type (BGS)

Detecting objects on a conveyor belt, ignoring the conveyor belt.

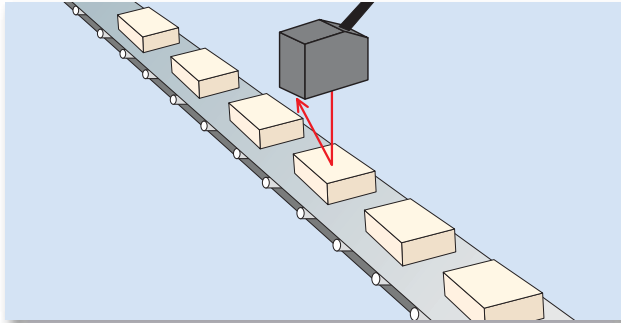

Detecting objects of different colors, ignoring workers in the background.

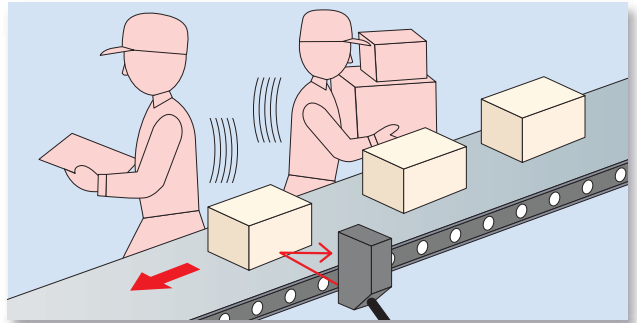

Detecting objects on a roller conveyor, ignoring other objects below.

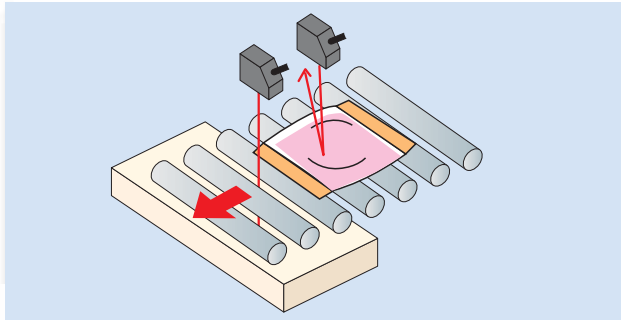

Detecting PC boards in an inspection line, ignoring other objects above the PC boards.

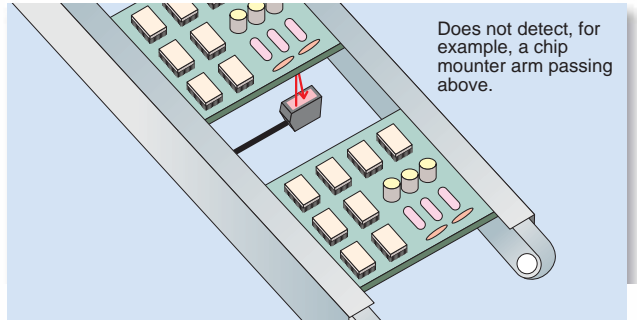

### Other Types

Retrieval system in a production line to detect whether or not correct objects have been retrieved.

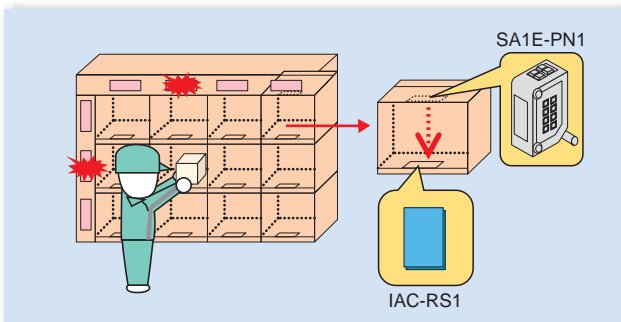

Determining objects by length.

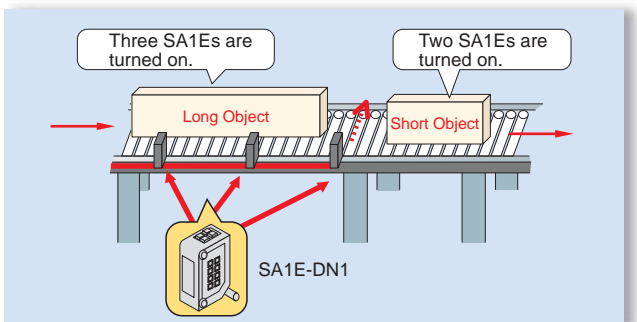

Checking whether the pre-determined volume of a substance has been dispensed.

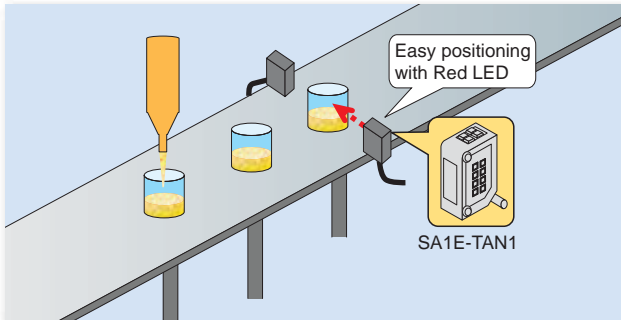

Detecting objects between doors.

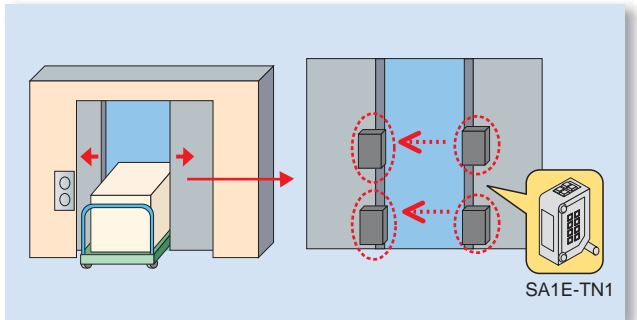

# SA1E Miniature Photoelectric Switches (Built-in Amplifier Type)

## Simple, small design for world-wide usage.

- Six sensing methods
- Cable type (three cable lengths) and M8 connector type are available.
- NPN output, PNP output, light ON, dark ON can be selected.
- Background suppression (BGS) type detects objects only, ignoring the background.
- Red LED type available for easy alignment in long distance applications (through-beam type, polarized retroreflective type, small-beam reflective type, BGS type)
- Convergent reflective type is ideal for detecting objects at a short distance with a background.
- Also available without sensitivity adjustment (through-beam, polarized retroreflective types)
- Air blower mounting block for installing an air blower to clean the lens surface. Ideal to maintain a clean lens surface and sensor performance.
- CE marked



## Types

### • Photoelectric Switches

Sensing Method		Sensing Range	Connection	Cable Length	Operation Mode	Type No.	
						NPN Output	PNP Output
Through-beam	Infrared LED	 See the characteristics on page 15.	Cable	1m	Light ON	SA1E-TN1	SA1E-TP1
					Dark ON	SA1E-TN2	SA1E-TP2
				2m	Light ON	SA1E-TN1-2M	SA1E-TP1-2M
					Dark ON	SA1E-TN2-2M	SA1E-TP2-2M
				5m	Light ON	SA1E-TN1-5M	SA1E-TP1-5M
					Dark ON	SA1E-TN2-5M	SA1E-TP2-5M
	w/Sensitivity Adjustment	 See the characteristics on page 16.	Connector	—	Light ON	SA1E-TN1C	SA1E-TP1C
					Dark ON	SA1E-TN2C	SA1E-TP2C
				1m	Light ON	SA1E-TN1-NA	SA1E-TP1-NA
					Dark ON	SA1E-TN2-NA	SA1E-TP2-NA
				2m	Light ON	SA1E-TN1-NA-2M	SA1E-TP1-NA-2M
					Dark ON	SA1E-TN2-NA-2M	SA1E-TP2-NA-2M
5m	Light ON	SA1E-TN1-NA-5M	SA1E-TP1-NA-5M				
	Dark ON	SA1E-TN2-NA-5M	SA1E-TP2-NA-5M				
Through-beam	Red LED	 See the characteristics on page 15.	Cable	1m	Light ON	SA1E-TAN1	SA1E-TAP1
					Dark ON	SA1E-TAN2	SA1E-TAP2
				2m	Light ON	SA1E-TAN1-2M	SA1E-TAP1-2M
					Dark ON	SA1E-TAN2-2M	SA1E-TAP2-2M
				5m	Light ON	SA1E-TAN1-5M	SA1E-TAP1-5M
					Dark ON	SA1E-TAN2-5M	SA1E-TAP2-5M
	w/Sensitivity Adjustment	 See the characteristics on page 15.	Connector	—	Light ON	SA1E-TAN1C	SA1E-TAP1C
					Dark ON	SA1E-TAN2C	SA1E-TAP2C
				1m	Light ON	SA1E-TAN1	SA1E-TAP1
					Dark ON	SA1E-TAN2	SA1E-TAP2
				2m	Light ON	SA1E-TAN1-2M	SA1E-TAP1-2M
					Dark ON	SA1E-TAN2-2M	SA1E-TAP2-2M
5m	Light ON	SA1E-TAN1-5M	SA1E-TAP1-5M				
	Dark ON	SA1E-TAN2-5M	SA1E-TAP2-5M				
Polarized Retroreflective	Red LED	 Note: Maintain at least the distance shown in the ( ) between the SA1E photoelectric switch and reflector. Reflectors are not supplied and must be ordered separately. See the characteristics on page 17.	Cable	1m	Light ON	SA1E-PN1	SA1E-PP1
					Dark ON	SA1E-PN2	SA1E-PP2
				2m	Light ON	SA1E-PN1-2M	SA1E-PP1-2M
					Dark ON	SA1E-PN2-2M	SA1E-PP2-2M
				5m	Light ON	SA1E-PN1-5M	SA1E-PP1-5M
					Dark ON	SA1E-PN2-5M	SA1E-PP2-5M
	w/Sensitivity Adjustment	 Note: Maintain at least the distance shown in the ( ) between the SA1E photoelectric switch and reflector. Reflectors are not supplied and must be ordered separately. See the characteristics on page 17.	Connector	—	Light ON	SA1E-PN1C	SA1E-PP1C
					Dark ON	SA1E-PN2C	SA1E-PP2C
				1m	Light ON	SA1E-PN1-NA	SA1E-PP1-NA
					Dark ON	SA1E-PN2-NA	SA1E-PP2-NA
				2m	Light ON	SA1E-PN1-NA-2M	SA1E-PP1-NA-2M
					Dark ON	SA1E-PN2-NA-2M	SA1E-PP2-NA-2M
5m	Light ON	SA1E-PN1-NA-5M	SA1E-PP1-NA-5M				
	Dark ON	SA1E-PN2-NA-5M	SA1E-PP2-NA-5M				

# SA1E Miniature Photoelectric Switches (Built-in Amplifier Type)

## Types

### • Photoelectric Switches

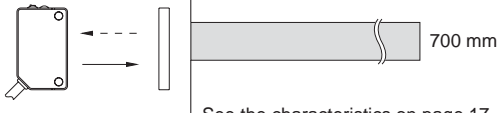
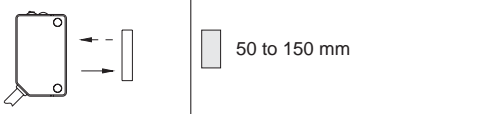
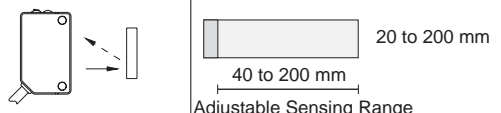
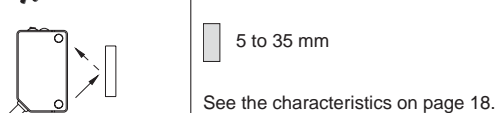
Sensing Method			Sensing Range	Connection	Cable Length	Operation Mode	Type No.	
							NPN Output	PNP Output
Diffuse-reflective	Infrared LED	w/Sensitivity Adjustment	 700 mm See the characteristics on page 17.	Cable	1m	Light ON	SA1E-DN1	SA1E-DP1
						Dark ON	SA1E-DN2	SA1E-DP2
					2m	Light ON	SA1E-DN1-2M	SA1E-DP1-2M
						Dark ON	SA1E-DN2-2M	SA1E-DP2-2M
					5m	Light ON	SA1E-DN1-5M	SA1E-DP1-5M
						Dark ON	SA1E-DN2-5M	SA1E-DP2-5M
Connector	—	Light ON	SA1E-DN1C	SA1E-DP1C				
Dark ON	SA1E-DN2C	SA1E-DP2C						
Small-beam Reflective	Red LED	w/Sensitivity Adjustment	 50 to 150 mm See the characteristics on page 17.	Cable	1m	Light ON	SA1E-NN1	SA1E-NP1
						Dark ON	SA1E-NN2	SA1E-NP2
					2m	Light ON	SA1E-NN1-2M	SA1E-NP1-2M
						Dark ON	SA1E-NN2-2M	SA1E-NP2-2M
					5m	Light ON	SA1E-NN1-5M	SA1E-NP1-5M
						Dark ON	SA1E-NN2-5M	SA1E-NP2-5M
Connector	—	Light ON	SA1E-NN1C	SA1E-NP1C				
Dark ON	SA1E-NN2C	SA1E-NP2C						
Background Suppression	Red LED	w/Sensing Range Adjustment	 20 to 200 mm 40 to 200 mm Adjustable Sensing Range See the characteristics on page 17.	Cable	1m	Light ON	SA1E-BN1	SA1E-BP1
						Dark ON	SA1E-BN2	SA1E-BP2
					2m	Light ON	SA1E-BN1-2M	SA1E-BP1-2M
						Dark ON	SA1E-BN2-2M	SA1E-BP2-2M
					5m	Light ON	SA1E-BN1-5M	SA1E-BP1-5M
						Dark ON	SA1E-BN2-5M	SA1E-BP2-5M
Connector	—	Light ON	SA1E-BN1C	SA1E-BP1C				
Dark ON	SA1E-BN2C	SA1E-BP2C						
Convergent Reflective	Infrared LED	w/Sensitivity Adjustment	 5 to 35 mm See the characteristics on page 18.	Cable	1m	Light ON	SA1E-GN1	SA1E-GP1
						Dark ON	SA1E-GN2	SA1E-GP2
					2m	Light ON	SA1E-GN1-2M	SA1E-GP1-2M
						Dark ON	SA1E-GN2-2M	SA1E-GP2-2M
					5m	Light ON	SA1E-GN1-5M	SA1E-GP1-5M
						Dark ON	SA1E-GN2-5M	SA1E-GP2-5M
Connector	—	Light ON	SA1E-GN1C	SA1E-GP1C				
Dark ON	SA1E-GN2C	SA1E-GP2C						

## Accessories (optional)

### • Slits (for through-beam type)

Item	Slit Size	Type No.	Ordering Type No.	Package Quantity
Vertical Slit	0.5 mm × 18 mm	SA9Z-S06	SA9Z-S06PN02	2
	1.0 mm × 18 mm	SA9Z-S07	SA9Z-S07PN02	
	2.0 mm × 18 mm	SA9Z-S08	SA9Z-S08PN02	
Horizontal Slit	0.5 mm × 6.5 mm	SA9Z-S09	SA9Z-S09PN02	
	1.0 mm × 6.5 mm	SA9Z-S10	SA9Z-S10PN02	
	2.0 mm × 6.5 mm	SA9Z-S11	SA9Z-S11PN02	
Round Slit	∅0.5 mm	SA9Z-S12	SA9Z-S12PN02	
	∅1.0 mm	SA9Z-S13	SA9Z-S13PN02	
	∅2.0 mm	SA9Z-S14	SA9Z-S14PN02	

### • Mounting Brackets

Item	Type No.	Package Quantity
Mounting Bracket	Vertical Mounting	SA9Z-K01
	Horizontal Mounting	SA9Z-K02
	Cover Type	SA9Z-K03

- Two mounting screws (M3 × 12 mm sems screws) are supplied with the SA9Z-K01 and SA9Z-K02.
- Two mounting screws (M3 × 14 mm sems screws) are supplied with the SA9Z-K03.
- The through-beam type requires two mounting brackets, one each for the projector and the receiver.
- The SA9Z-K02 cannot be used for the connector type.
- Contact IDEC about mounting brackets for the connector type.

### • Reflectors (for polarized retroreflective type)

Item	Type No.	Package Quantity
Reflector	Standard	IAC-R5
	Small	IAC-R6
	Large	IAC-R8
	Narrow (rear/side mounting)	IAC-R7M
	Narrow (rear mounting)	IAC-R7B
	Narrow (side mounting)	IAC-R7S
	Tape Type (40 × 35 mm)	IAC-RS1
	Tape Type (80 × 70 mm)	IAC-RS2
Reflector Mounting Bracket	For IAC-R5	IAC-L2
	For IAC-R6	IAC-L3
	For IAC-R8	IAC-L5

- The IAC-L2 is not supplied with mounting screws and nuts. Use commercially available M4 screws and nuts for mounting the IAC-R5 reflector.
- The IAC-L3 is supplied with two mounting screws (M3 × 8 mm sems screws).
- The IAC-L5 is supplied with two mounting screws (M4 × 10 mm sems screws).
- The IAC-R7M and IAC-R7S are supplied with two M3 × 8 mm self-tapping screws, two flat washers, and two spring washers.
- The IAC-R7B is supplied with an M3 × 8 mm self-tapping screw, a flat washer, and a spring washer.

# SA1E Miniature Photoelectric Switches (Built-in Amplifier Type)

## • Connector Cable (for connector type)

Number of Core Wires	Type & Length	Type No.	Package Quantity
4	Straight, 2m	SA9Z-CM8K-4S2	1
	Right angle, 2m	SA9Z-CM8K-4L2	
	Straight, 5m	SA9Z-CM8K-4S5	
	Right angle, 5m	SA9Z-CM8K-4L5	

## • Air Blower Mounting Block

Item	Type No.	Package Quantity
Air Blower Mounting Block	SA9Z-A02	1

- Two mounting screws (M3 × 20 mm sems screws), one M5 × 6 mm screw for plugging the air supply port, and one gasket (0.5 mm thick) are supplied.
- The air tube fitting and mounting bracket are not supplied and must be ordered separately (recommended mounting bracket: SA9Z-K01).
- Material: Anodized aluminum surface

## Specifications

Sensing Method	Through-beam	Polarized Retroreflective	Diffuse-reflective	Small-beam Reflective	Background Suppression (BGS)	Convergent Reflective
Type No.	SA1E-T	SA1E-P	SA1E-D	SA1E-N	SA1E-B	SA1E-G
Power Voltage	12 to 24V DC (Operating range: 10 to 30V DC) Equipped with reverse-polarity protection					
Current Draw	Projector: 15 mA Receiver: 20 mA	30 mA				
Sensing Range	10m (with sensitivity adjustment)  15m (without sensitivity adjustment)	With sensitivity adjustment: 2.5m (IAC-R5/R8) 1.5m (IAC-R6) 1.3m (IAC-RS2) 1.0m (IAC-RS1) 0.8m (IAC-R7□) (Note 1)  Without sensitivity adjustment: 3.0m (IAC-R5/R8) 2.0m (IAC-R6) 1.4m (IAC-RS2) 1.1m (IAC-RS1) 1.0m (IAC-R7□) (Note 1)	700 mm (using 200 × 200 mm white mat paper)	50 to 150 mm (using 100 × 100 mm white mat paper)	20 mm to preset (using 200 × 200 mm white mat paper)	5 to 35 mm (using 100 × 100 mm white mat paper)
Adjustable Sensing Range	—				40 to 200 mm	—
Detectable Object	Opaque		Opaque/Transparent		Opaque	Opaque/Transparent
Hysteresis	—		20% maximum		10% maximum	20% maximum
Response Time	1 ms maximum					
Sensitivity Adjustment	Adjustable using a potentiometer (approx. 260°) Through-beam type and polarized retroreflective type are also available without sensitivity adjustment.				—	Adjustable using a potentiometer (approx. 260°)
Sensing Range Adjustment	—				6-turn control knob	—
Light Source Element	Infrared LED Red LED	Red LED	Infrared LED	Red LED	Red LED	Infrared LED
Operation Mode	Light ON/Dark ON					
Control Output	NPN open collector or PNP open collector 30V DC, 100 mA maximum Voltage drop: 1.2V maximum (BGS type: 2V maximum) Short-circuit protection					
LED Indicators	Operation LED: Yellow Stable LED: Green Power LED: Green (Through-beam type projector)				Operation LED: Yellow Stable LED: None	Operation LED: Yellow Stable LED: Green
Interference Prevention	— Two units can be mounted in close proximity.					
Degree of Protection	IP67 (IEC 60529)					
Extraneous Light Immunity	Sunlight: 10,000 lux maximum, Incandescent lamp: 5,000 lux maximum (at receiver)					
Operating Temperature	−25 to +55°C (no freezing)					
Operating Humidity	35 to 85% RH (no condensation)					
Storage Temperature	−40 to +70°C (no freezing)					
Insulation Resistance	Between live part and mounting bracket: 20 MΩ minimum (500V DC megger)					
Dielectric Strength	Between live part and mounting bracket: 1000V AC, 50/60 Hz, 1 minute					
Vibration Resistance	Damage limits: 10 to 55 Hz, Amplitude 0.75 mm, 20 cycles in each of 3 axes					
Shock Resistance	Damage limits: 500 m/s <sup>2</sup> , 10 shocks in each of 3 axes					
Material	Housing: PC/PBT, Lens: PC (Polarized retroreflective type: PMMA), Indicator cover: PC					
Attachments	Instruction sheet, Sensitivity control screwdriver					
Weight (approx.)	Cable Type	Projector: 30g Receiver: 30g (Note 2)	30g (Note 2)		35g (Note 3)	30g (Note 2)
	Connector Type	Projector: 10g Receiver: 10g	10g		20g	10g
Connection Method	Cable Type	ø3.5 mm, 3-core, 0.2 mm <sup>2</sup> , 1-m vinyl cable (2-core for the projector of through-beam type)				
	Connector Type	M8 connector (4-pin)				

Note 1: Maintain at least the distance shown below between the SA1E photoelectric switch and reflector.

IAC-R5/R6/R7□/R8: 100 mm

IAC-RS1/RS2: 150 mm

The detection distance cannot be guaranteed if the reflector is deformed or the tape type reflector is applied on uneven surface.

Note 2: Cable length: 1m (50g when the cable length is 2m. 110g when the cable length is 5m.)

Note 3: Cable length: 1m (55g when the cable length is 2m. 120g when the cable length is 5m.)



# SA1E Miniature Photoelectric Switches (Built-in Amplifier Type)

## Slit and Sensing Range

A slit, which changes the beam size of through-beam sensors, can easily be attached to the sensing side of the through-beam projector and receiver. Three different slit widths are available.

The slit can be pressed to snap onto the front easily.

Slit		w/Sensitivity Adjustment				w/o Sensitivity Adjustment			
		Sensing Range (m)		Minimum Detectable Object Width (mm)		Sensing Range (m)		Minimum Detectable Object Width (mm)	
Type No.	Slit Width: A	Used on one side	Used on both sides	Used on one side	Used on both sides	Used on one side	Used on both sides	Used on one side	Used on both sides
SA9Z-S06	0.5 mm	2.5	1.0	7.0	0.5	5.0	1.5	7.0	0.5
SA9Z-S07	1.0 mm	3.5	1.5	7.0	1.0	7.0	3.0	7.0	1.0
SA9Z-S08	2.0 mm	6.0	3.5	7.0	2.0	9.0	5.5	7.0	2.0
SA9Z-S09	0.5 mm	2.0	0.7	7.0	0.4	4.0	1.5	7.0	0.5
SA9Z-S10	1.0 mm	3.0	1.5	7.0	0.7	7.0	2.5	7.0	0.8
SA9Z-S11	2.0 mm	5.5	3.0	7.0	1.5	9.0	5.0	7.0	1.5
SA9Z-S12	0.5 mm	0.8	0.08	5.0	0.3	1.3	0.1	5.0	0.5
SA9Z-S13	1.0 mm	1.5	0.3	5.0	0.6	2.5	0.3	5.0	0.6
SA9Z-S14	2.0 mm	2.5	1.2	5.0	1.5	5.5	1.6	5.0	1.7

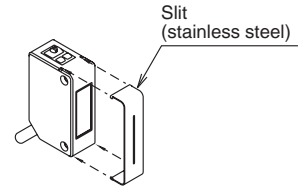

Horizontal slits and round slits have an orientation. Make sure that the TOP marking comes on top of the sensor (LED side).

Used on one side: Slit is attached to the receiver only.

## Dimensions

### • Vertical Slit

SA9Z-S06  
SA9Z-S07  
SA9Z-S08

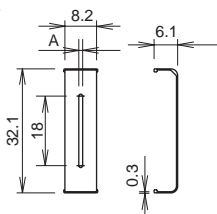

Material: Stainless Steel

### • Horizontal Slit

SA9Z-S09  
SA9Z-S10  
SA9Z-S11

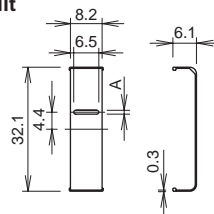

### • Round Slit

SA9Z-S12  
SA9Z-S13  
SA9Z-S14

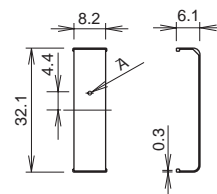

All dimensions are in mm.

## Output Circuit & Wiring Diagram

### • NPN Output

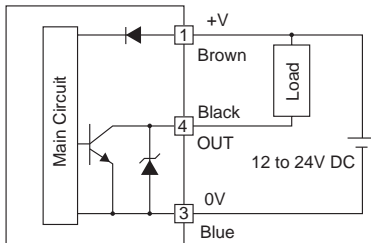

### • PNP Output

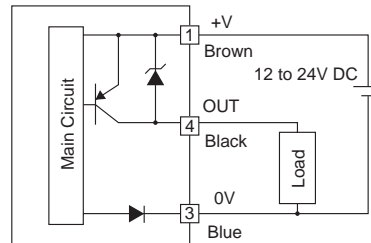

### • Through-beam Type Projector

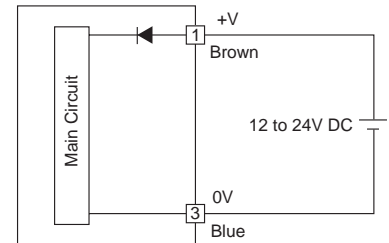

(Connector Pin Assignment)

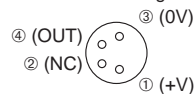

(Connector Pin Assignment)

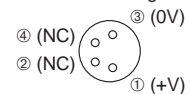

# SA1E Miniature Photoelectric Switches (Built-in Amplifier Type)

## Dimensions

### • Cable Type Through-beam



Polarized retroreflective  
Diffuse-reflective  
Small-beam reflective  
Convergent reflective



- Through-beam
- Polarized retroreflective
- Diffuse-reflective
- Small-beam reflective
- Convergent Reflective

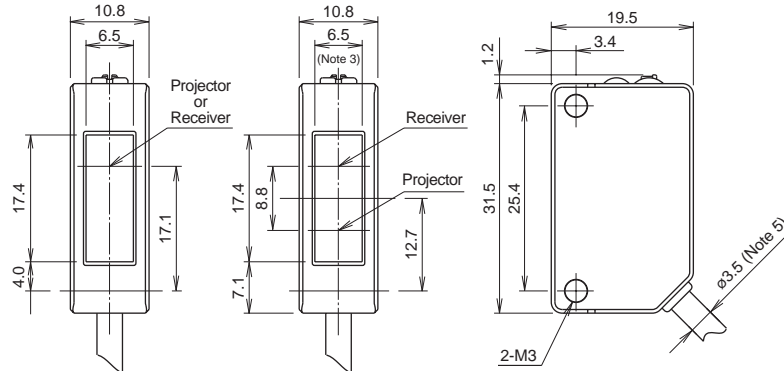
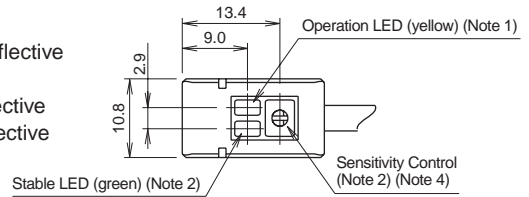

- Note 1: Power ON LED (green) for through-beam projector  
 Note 2: No sensitivity control and stable LED are attached on the through-beam projector.  
 Note 3: 5.2 mm for polarized retroreflective type  
 Note 4: No sensitivity control is installed on the type without sensitivity adjustment.  
 Note 5: Cable length depends on types.

### Background Suppression (BGS)

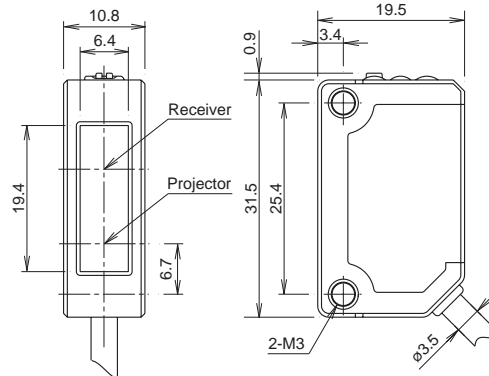
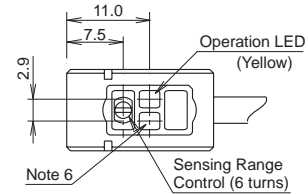

Note 6: Stable LED is not provided on the background suppression type.

All dimensions in mm.

# SA1E Miniature Photoelectric Switches (Built-in Amplifier Type)

## • Connector Type Through-beam



Polarized retroreflective  
Diffuse-reflective  
Small-beam reflective  
Convergent reflective



- Through-beam
- Polarized retroreflective
- Diffuse-reflective
- Small-beam reflective
- Convergent reflective

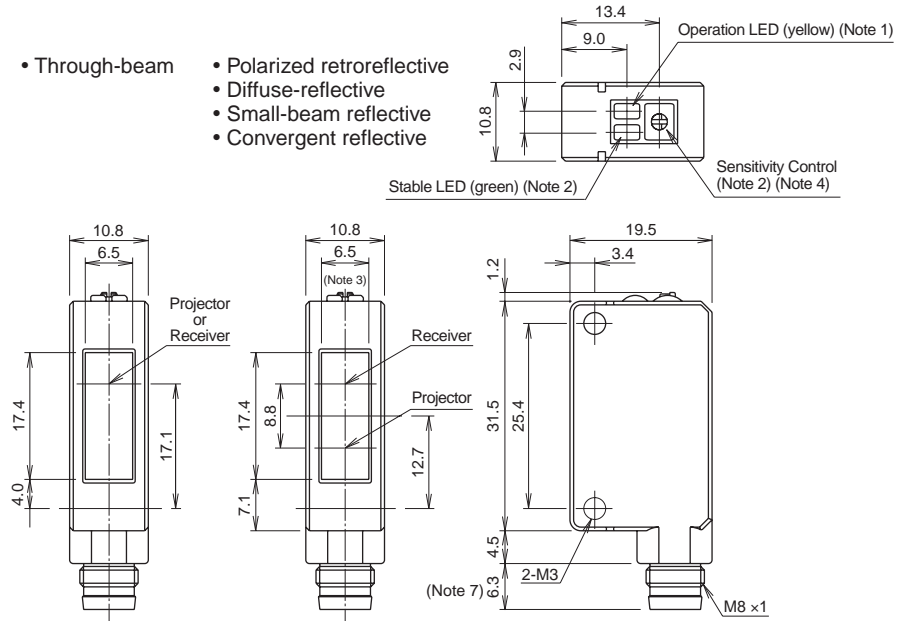

- Note 1: Power ON LED (green) for through-beam projector  
 Note 2: No sensitivity control and stable LED are attached on the through-beam projector.  
 Note 3: 5.2 mm for polarized retroreflective type  
 Note 4: No sensitivity control is installed on the type without sensitivity adjustment.  
 Note 5: Cable length depends on types.

## Background Suppression (BGS)

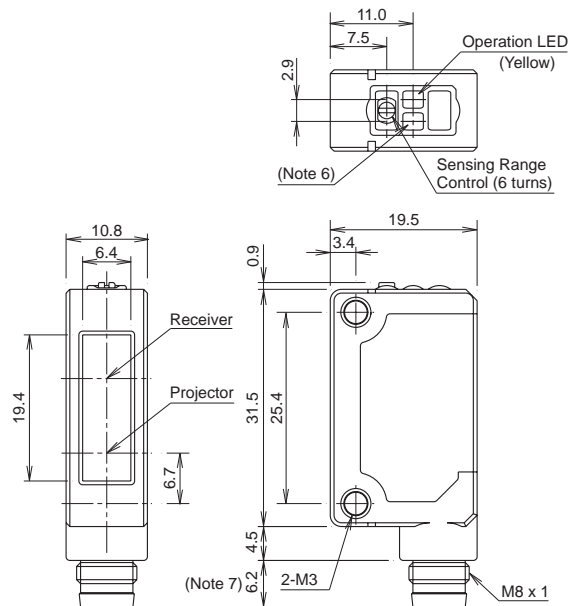

- Note 6: Stable LED is not provided on the background suppression type.  
 Note 7: The connector length is 18 mm when a right-angle connector cable (SA9Z-CM8K-4L\*) is attached.

All dimensions in mm.

# SA1E Miniature Photoelectric Switches (Built-in Amplifier Type)

## Dimensions

### • Mounting Bracket SA9Z-K01

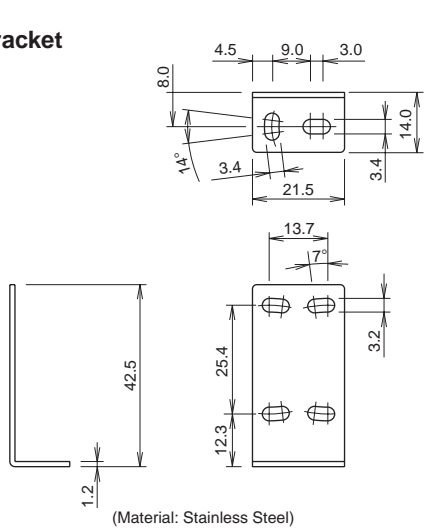

### With Mounting Bracket

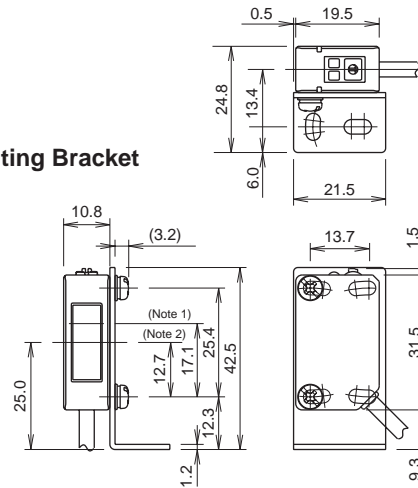

### SA9Z-K02

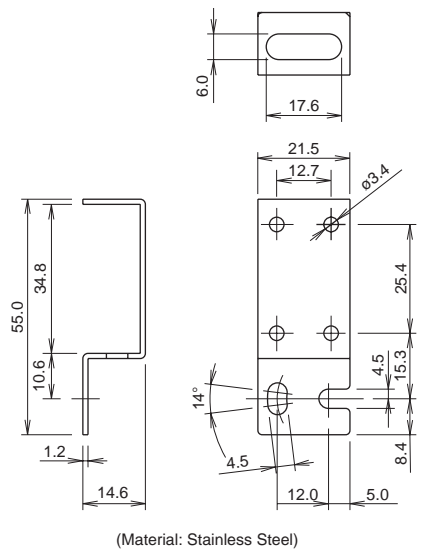

### With Mounting Bracket

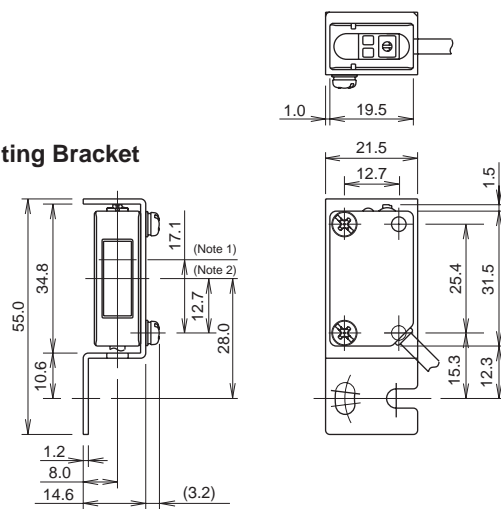

### SA9Z-K03

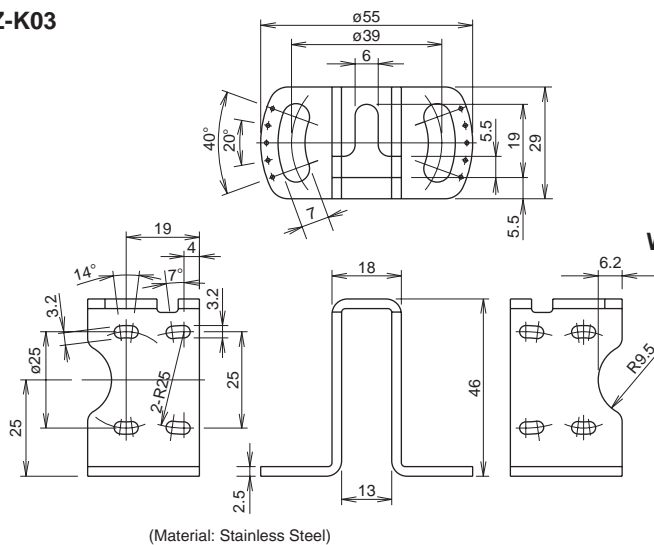

### With Mounting Bracket

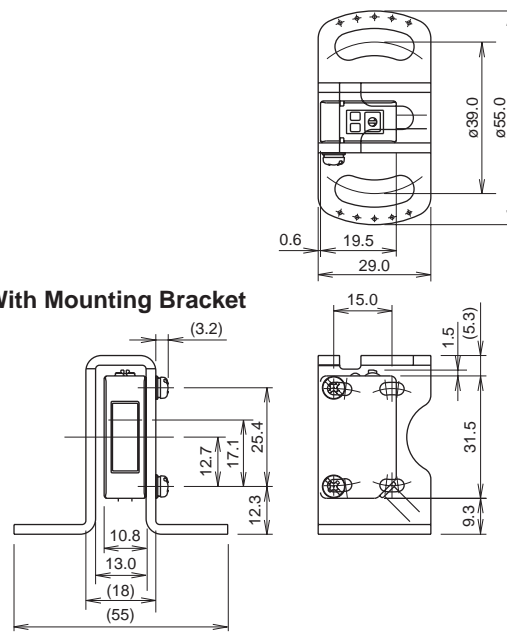

All dimensions are in mm.

# SA1E Miniature Photoelectric Switches (Built-in Amplifier Type)

• Reflector

IAC-R5

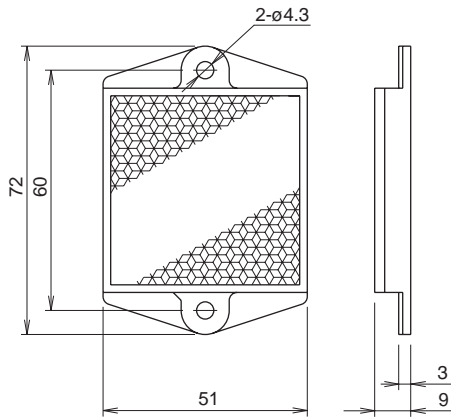

(Effective reflecting area: 47.2 × 47.2)

IAC-R6

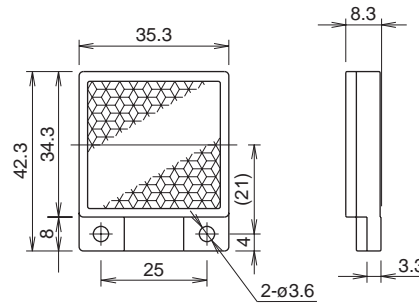

(Effective reflecting area: 30 × 31)

IAC-R8

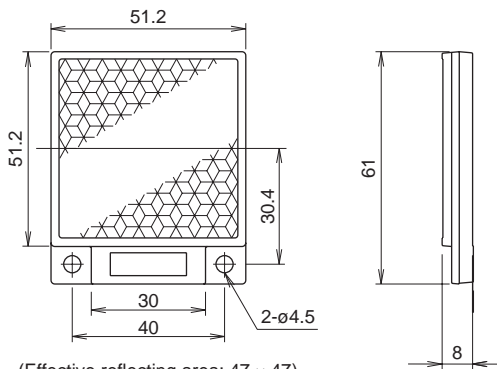

(Effective reflecting area: 47 × 47)

IAC-RS1

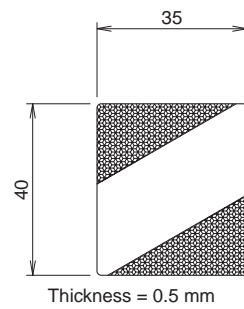

IAC-RS2

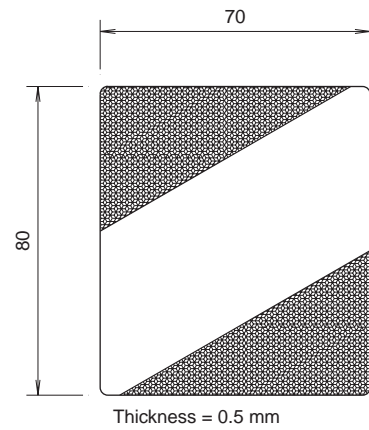

IAC-R7M (rear/side mounting)

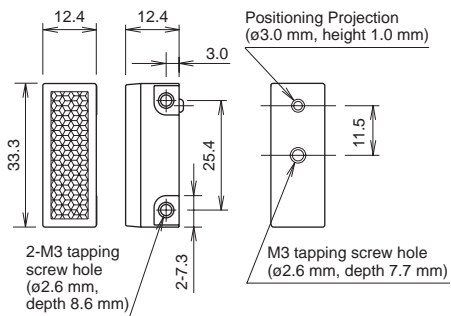

IAC-R7B (rear mounting)

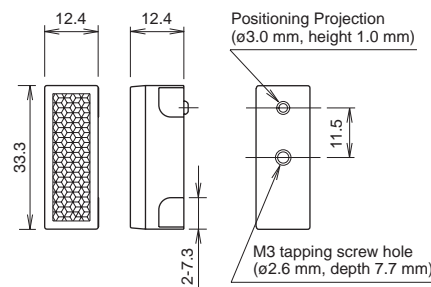

IAC-R7S (side mounting)

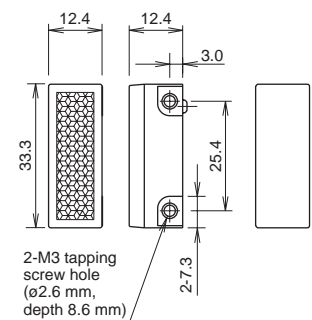

- Effective reflecting area: 8.6 × 29.5
- The mounting plate for reflector must be 0.8 to 2.5 mm in thickness.

All dimensions are in mm.

# SA1E Miniature Photoelectric Switches (Built-in Amplifier Type)

## Dimensions

### • Reflector Mounting Bracket

#### IAC-L2 (for IAC-R5)

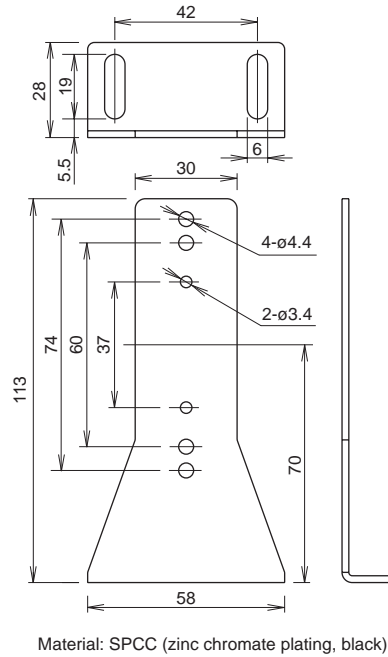

#### IAC-L3 (for IAC-R6)

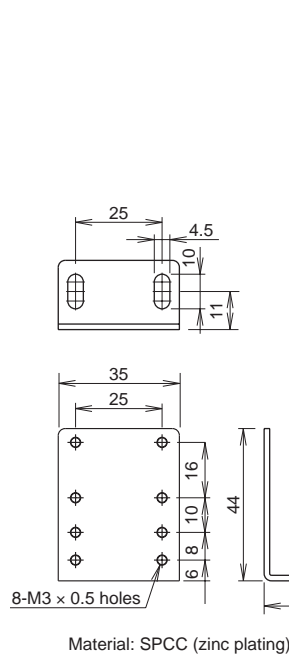

#### IAC-L5 (for IAC-R8)

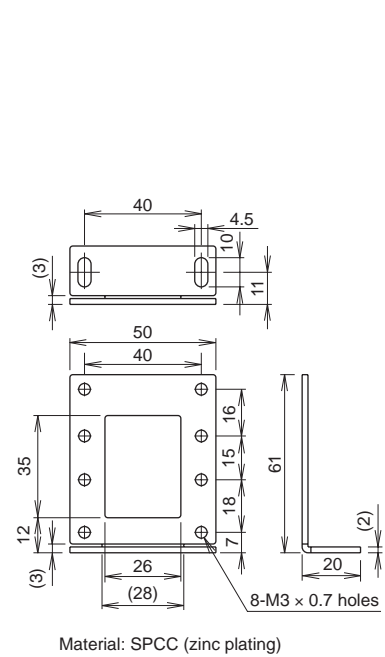

### • Connector Cable (connector on one end)

#### Straight Type (SA9Z-CM8K-4S□)

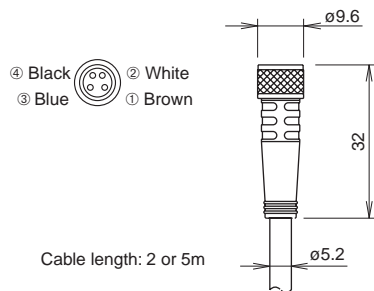

#### Right-angle Type (SA9Z-CM8K-4L□)

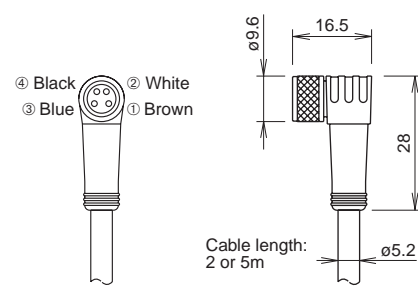

• Dielectric strength when installed on the SA1E: 1000V AC (between live part and mounting bracket, except between live part and tightening ring)

### • Air Blower Mounting Block

#### SA9Z-A02

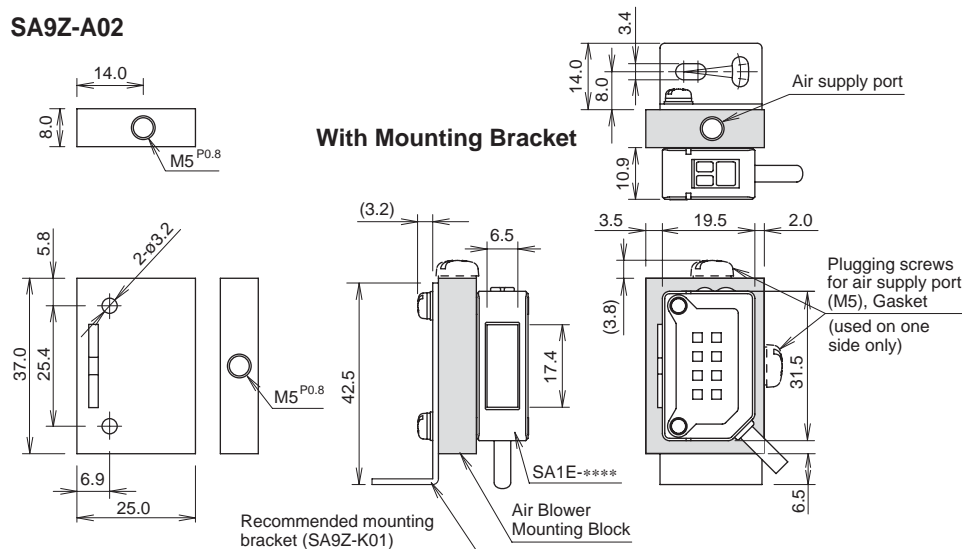

- The SA9Z-A02 air blower mounting block is supplied with two mounting screws (M3 x 20 mm semi screws), one screw for plugging the air supply port (M5 x 6 mm), and one gasket for plugging the air supply port.
- An air tube fitting (M5) can be installed to either the top or side. Tighten the fitting to a torque of 0.5 N-m maximum.
- The air tube fitting and mounting bracket are not supplied and must be ordered separately (recommended mounting bracket: SA9Z-K01).

(Material: Anodized aluminum surface)

All dimensions are in mm.

# SA1E Miniature Photoelectric Switches (Built-in Amplifier Type)

## Characteristics (Typical)

### 1-1. Through-beam Type SA1E-T (Infrared LED w/sensitivity adjustment) SA1E-TA (Red LED w/sensitivity adjustment)

• Excess Gain (Without slit)

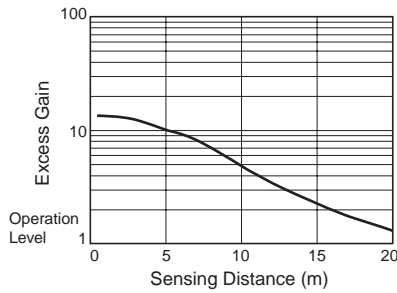

• Lateral Displacement (Without slit)

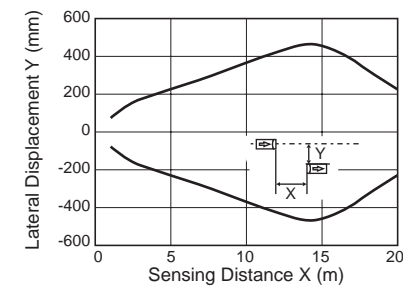

• Angle (Without slit)

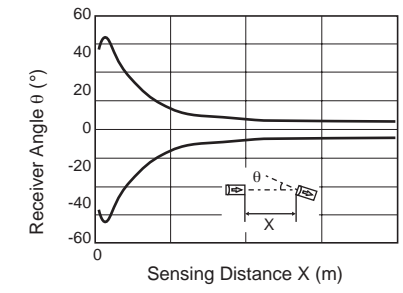

• Excess Gain (With vertical slit)

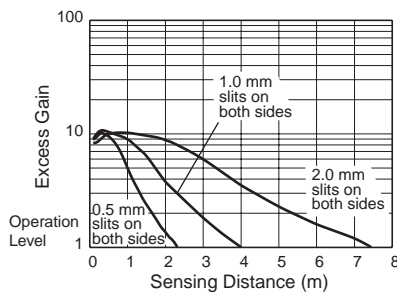

• Excess Gain (With horizontal slit)

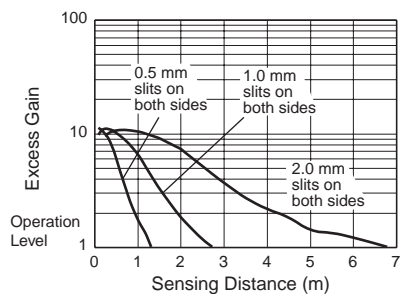

• Excess Gain (With round slit)

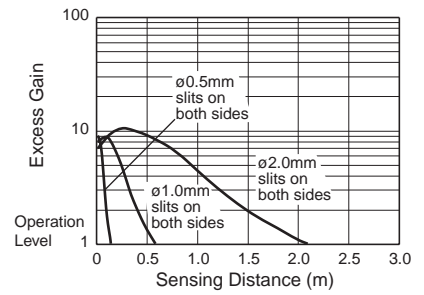

• Lateral Displacement (With 0.5-mm vertical slit)

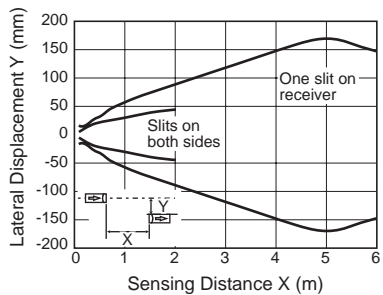

• Lateral Displacement (With 1.0-mm vertical slit)

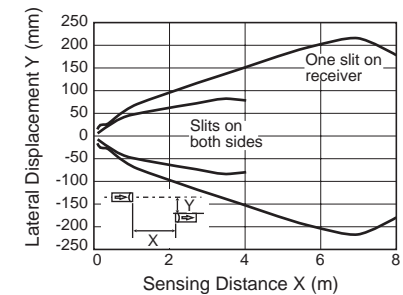

• Lateral Displacement (With 2.0-mm vertical slit)

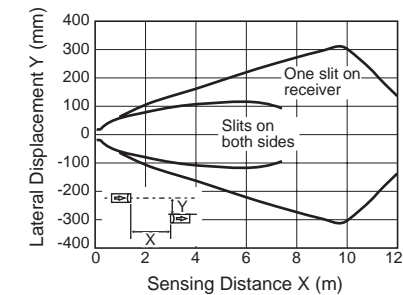

• Lateral Displacement (With 0.5-mm horizontal slit)

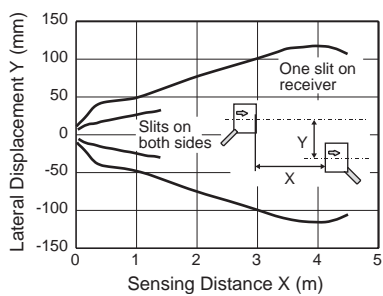

• Lateral Displacement (With 1.0-mm horizontal slit)

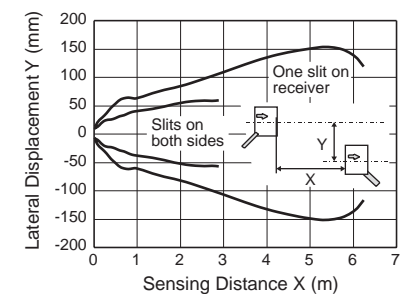

• Lateral Displacement (With 2.0-mm horizontal slit)

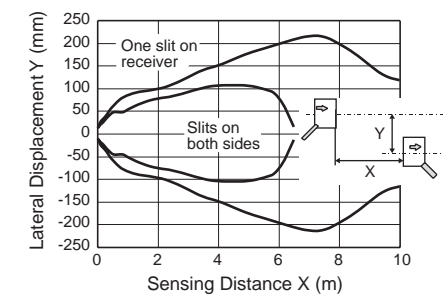

• Lateral Displacement (With ø0.5-mm round slit)

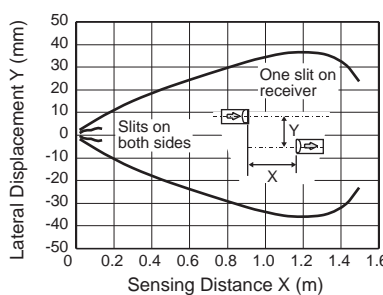

• Lateral Displacement (With ø1.0-mm round slit)

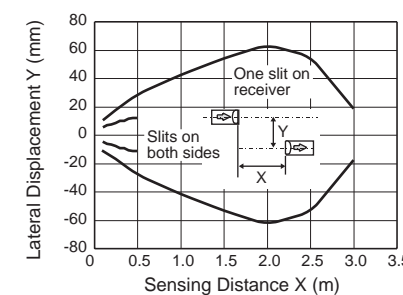

• Lateral Displacement (With ø2.0-mm round slit)

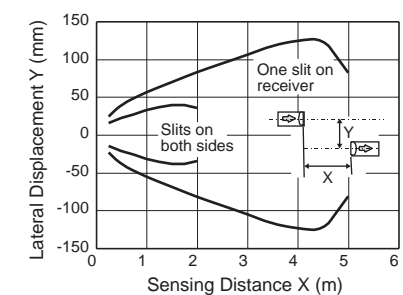

# SA1E Miniature Photoelectric Switches (Built-in Amplifier Type)

## Characteristics (Typical)

### 1-2. Through-beam Type SA1E-T\*-NA (Infrared LED w/o sensitivity adjustment)

• Excess Gain (Without slit)

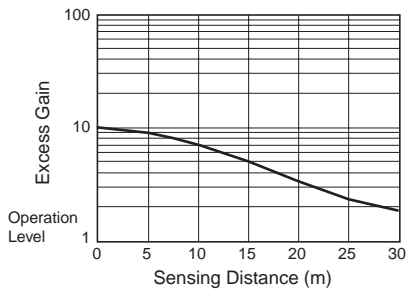

• Lateral Displacement (Without slit)

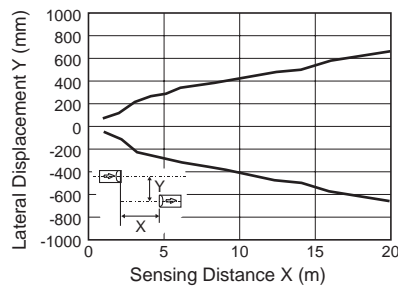

• Angle (Without slit)

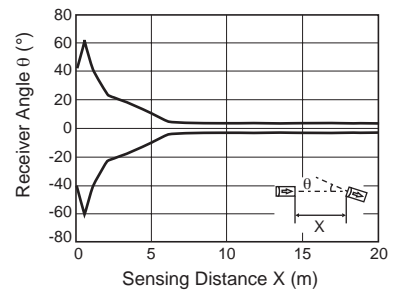

• Excess Gain (With vertical slit)

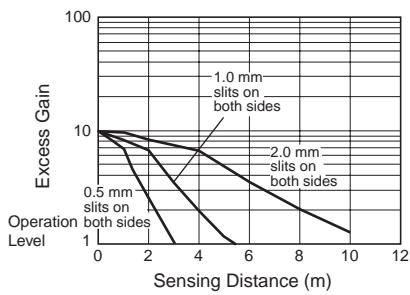

• Excess Gain (With horizontal slit)

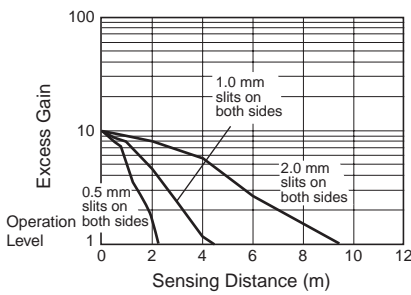

• Excess Gain (With round slit)

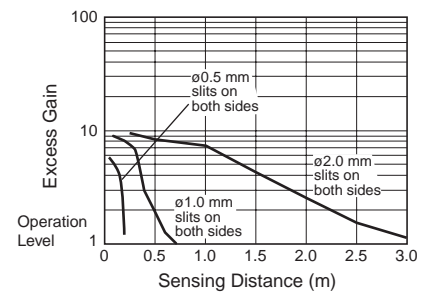

• Lateral Displacement (With 0.5-mm vertical slit)

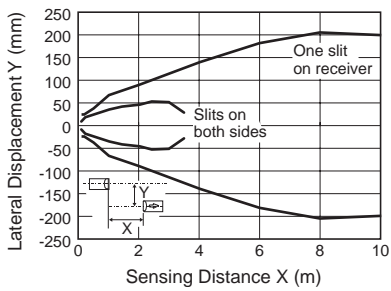

• Lateral Displacement (With 1.0-mm vertical slit)

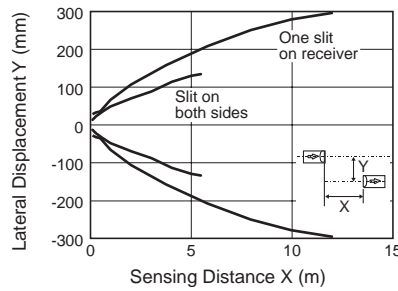

• Lateral Displacement (With 2.0-mm vertical slit)

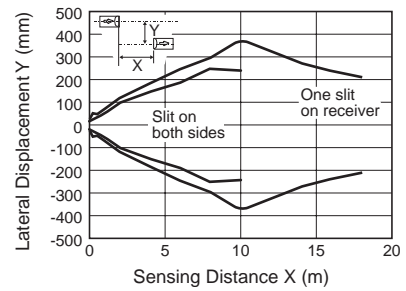

• Lateral Displacement (With 0.5-mm horizontal slit)

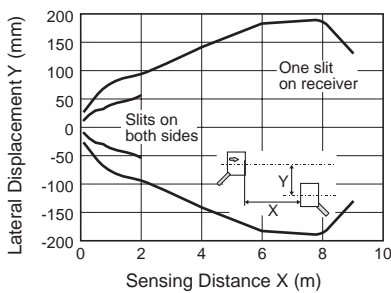

• Lateral Displacement (With 1.0-mm horizontal slit)

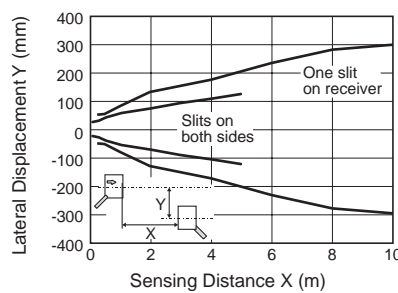

• Lateral Displacement (With 2.0-mm horizontal slit)

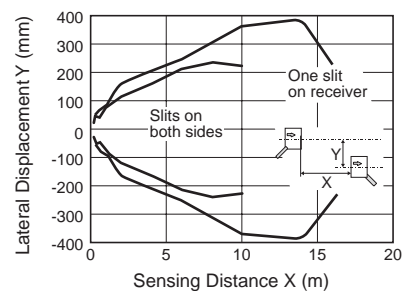

• Lateral Displacement (With ø0.5-mm round slit)

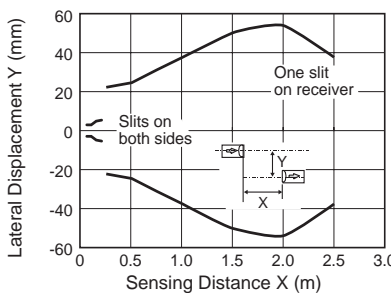

• Lateral Displacement (With ø1.0-mm round slit)

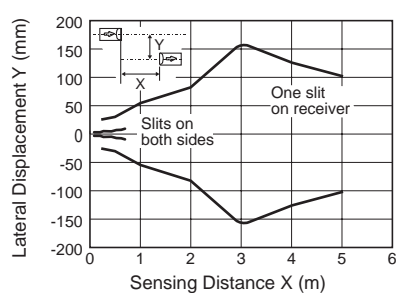

• Lateral Displacement (With ø2.0-mm round slit)

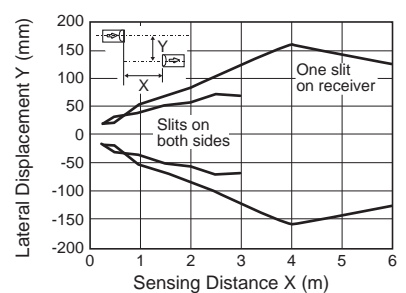



# SA1E Miniature Photoelectric Switches (Built-in Amplifier Type)

## Characteristics (Typical)

### 2-1. Polarized Retroreflective Type SA1E-P (Red LED w/sensitivity adjustment)

• Excess Gain

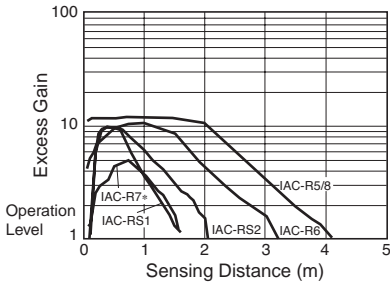

• Lateral Displacement

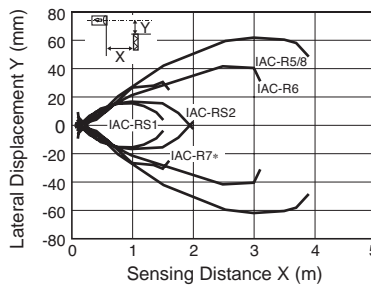

• Angle (when using IAC-R5/-R8)

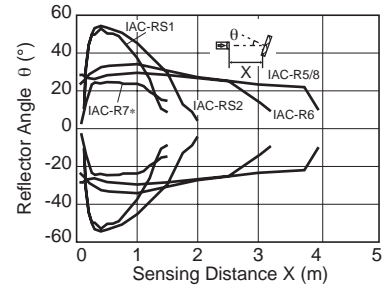

### 2-2. Polarized Retroreflective Type SA1E-P\*-NA (Red LED w/o sensitivity adjustment)

• Excess Gain

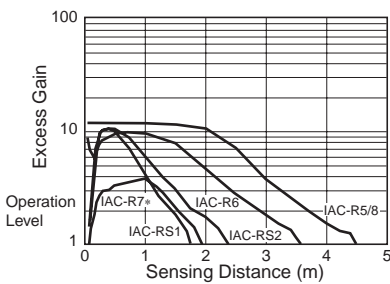

• Lateral Displacement

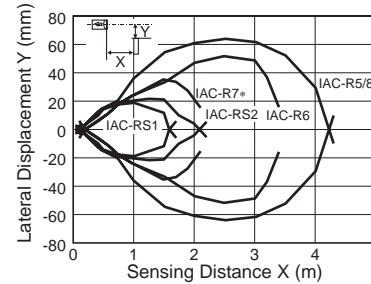

• Angle (when using IAC-R5/-R8)

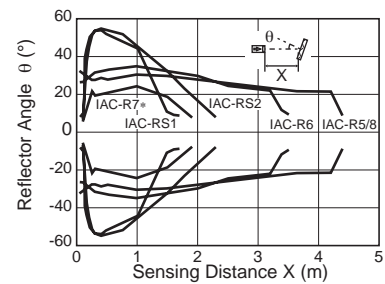

### 3. Diffuse-Reflective Type SA1E-D (Infrared LED w/sensitivity adjustment)

• Excess Gain

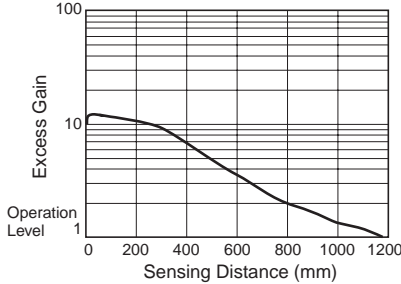

• Sensing Area

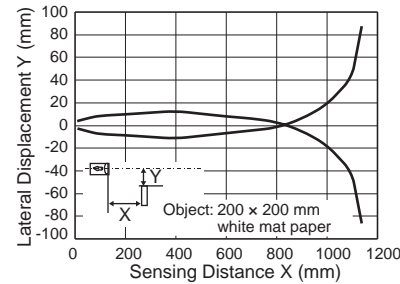

• Object Size vs. Sensing Distance

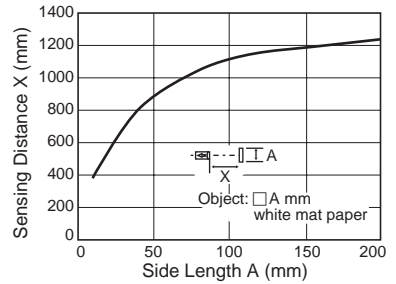

### 4. Small-beam Reflective Type SA1E-N (Red LED w/sensitivity adjustment)

• Excess Gain

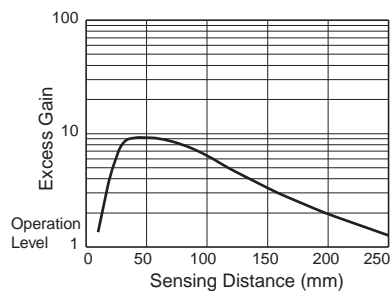

• Sensing Area

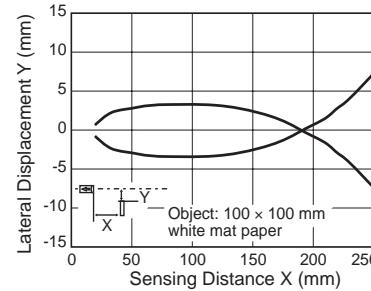

• Object Size vs Sensing Distance

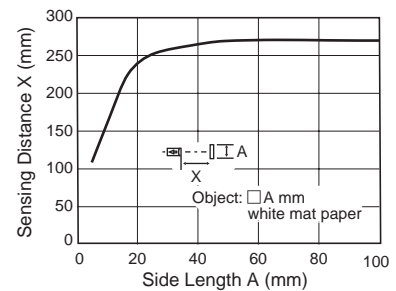

### 5. Background Suppression Type SA1E-B (Red LED w/sensitivity adjustment)

• Lateral Displacement (Preset 100 mm)

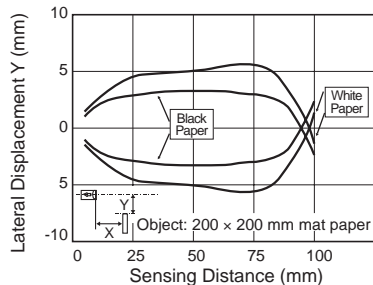

• Lateral Displacement (Preset 200 mm)

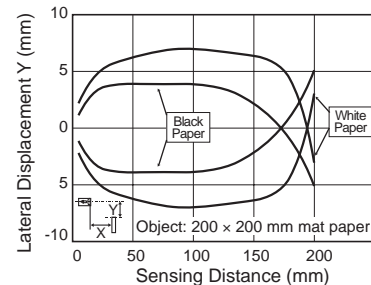

• Light Beam Diameter

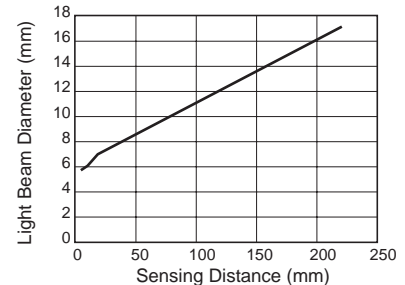

# SA1E Miniature Photoelectric Switches (Built-in Amplifier Type)

## • Sensing Distance vs. Hysteresis

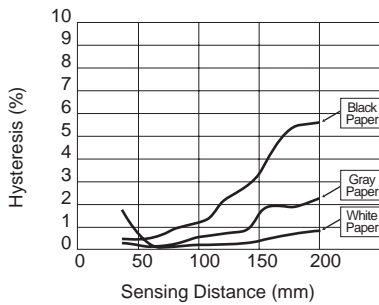

## • Control Knob vs. Sensing Distance

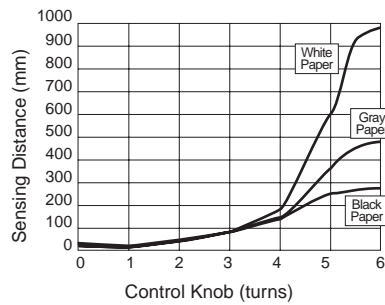

## • Color Mat Paper and Other Materials

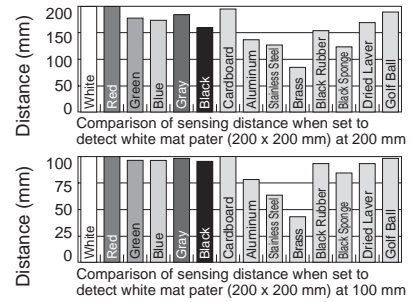

## 6. Convergent Reflective Type SA1E-G (Infrared LED w/sensitivity adjustment)

### • Excess Gain

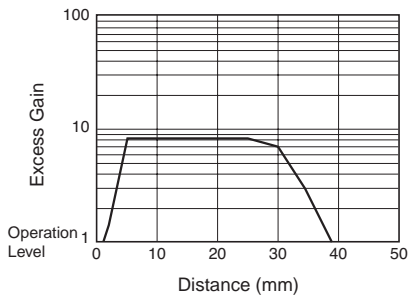

### • Lateral Displacement

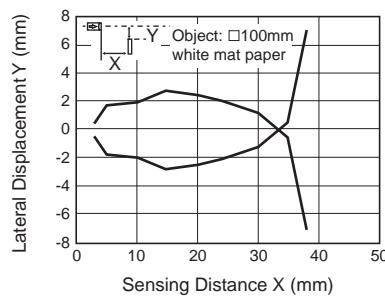

### • Object Size vs. Sensing Distance

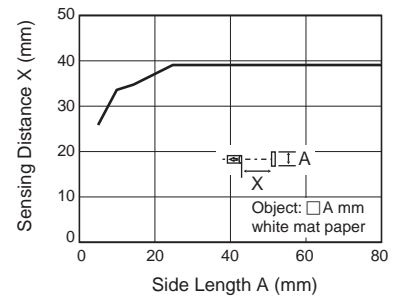

### • Brightness vs. Sensing Distance

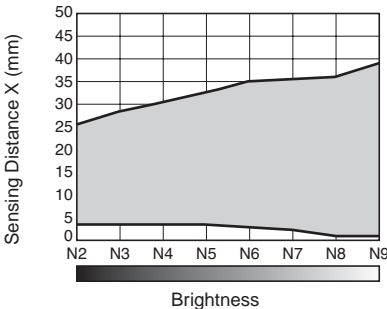

Object: Colour chips of colour standards according to JIS Z8721 (Non Glossy Edition)

### • Color Mat Paper and Other Materials

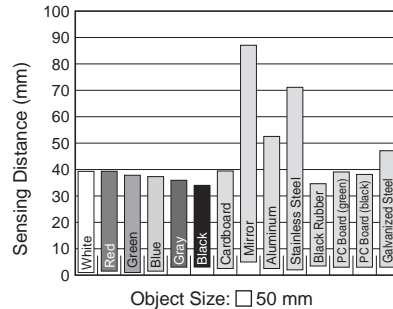

- The graph on the left shows the sensing distances for different colors and materials and can be used as a reference when setting the distance. Because sensing distance depends on the object's size and surface condition, provide a sufficient distance.
- Note that sensing may be affected by reflective object behind the sensing object.
- Referring to the graph on the left, provide a sufficient distance between the photoelectric switch and background.

## Instructions

### 1. Indicator and Output Operation (except for background suppression type)

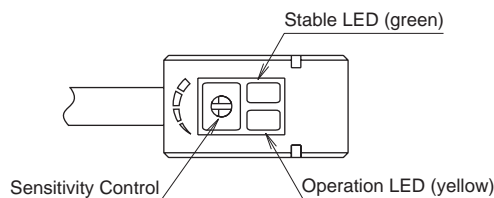

- The operation LED turns on (yellow) when the control output is on.
- The stable LED turns on (green) either at stable incident or stable interruption. Make sure to use the photoelectric switch after the stable operation is ensured.
- In the light ON operation, the output turns on when the receiving light intensity level is 1.0 or over as shown on the right.
- In the dark-ON operation, the output turns on when the receiving light intensity level is 1.0 or less as shown on the right.

Receiving Light Intensity Level	Light Receiving Status	Stable LED (green)	Operation LED (yellow)/ Control Output	
			Light ON	Dark ON
Operation Level	1.2 and over	Stable Incident	ON	OFF
	1.0	Unstable Incident	ON	OFF
		Unstable Interruption	OFF	ON
0.8 and below	Stable Interruption	ON	ON	ON

### 2. Optical Axis Alignment (Light ON)

#### • Through-beam type

Fasten the receiver temporarily. Place the projector to face the receiver. Move the projector up, down, right and left to find the range where the operation LED turns on. Fasten the projector in the middle of the range. Next, move the receiver up, down, right and left in the same manner and fasten in the middle of the range where the operation LED turns on. Make sure that stable LED turns on at stable incident and stable interruption.

# SA1E Miniature Photoelectric Switches (Built-in Amplifier Type)

## • Polarized retroreflective type

Install the reflector perpendicularly to the optical axis. Move the SA1E photoelectric switch up, down, right and left to find the range where the operation LED turns on. Fasten the switch in the middle of the range. Polarized retroreflective type can be installed also by finding the position where the reflection of projected red light is most intense, while observing the reflection on the reflector from behind the switch. Make sure that stable LED turns on at stable incident and stable interruption.

## • Diffuse-reflective type/Small-beam reflective type/Convergent reflective type

Place the SA1E photoelectric switch where the switch can detect the object. Move the switch up, down, right and left to find the range where the operation LED turns on. Fasten the switch in the middle of the range. Make sure that stable LED turns on at stable incident and stable interruption. Because the light source element of small-beam reflective type is a red LED, visual inspection is possible as well.

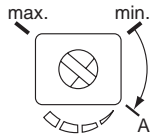
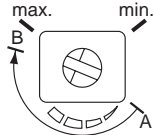
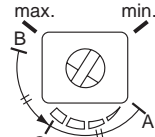

## 3. Sensitivity Adjustment

- Referring to the table below, adjust the sensitivity of the SA1E photoelectric switch when necessary, in such cases as the through-beam type is used to detect small or translucent objects or the reflective type is affected by background. The table explains the status of operation LED when the operation mode is set to light ON.
- After adjusting the sensitivity, make sure that stable LED turns on at stable incident and stable interruption. For detecting objects too small to turn on the stable LED, use an optional slit.
- Sensitivity is set to the maximum at the factory before shipment. When adjusting the sensitivity, use the screwdriver supplied with the SA1E photoelectric switch to turn the control as shown below, to a torque of 0.05 N·m maximum.

Step	Photoelectric Switch Status	Sensitivity Control	Adjusting Procedure
1	<b>Receiving light</b> • Through-beam, polarized reflective: No object detected • Diffuse reflective, small-beam reflective, convergent reflective: Object detected		Turn the control counterclockwise to the minimum. Then turn clockwise until the operation LED turns on (turns off with dark ON type) (point A).
2	<b>Light is interrupted</b> • Through-beam, polarized reflective: Object detected • Diffuse reflective, small-beam reflective, convergent reflective: No object detected		At interruption status, turn the control clockwise from point A, until the operation LED turns on (turns off with dark ON type) (point B). If the operation LED does not turn on (turn off with dark ON type) even though the control has reached the maximum, set the maximum position as point B.
3			Set the middle point between point A and B as point C.

## 4. Adjustment of Sensing Range for Background Suppression (BGS) Type

- When adjusting the sensing range, follow the instruction below.

Step	Distance Control	Adjusting Procedure
1		Install the photoelectric switch and the object firmly. Turn the control counterclockwise until the operation LED turns off (turns on with dark ON type). From this point, turn the control clockwise until the operation LED turns on (turns off with dark ON type) (point A).
2		Remove the object, and confirm that the operation LED turns off (turns on with dark ON type). Turn the control clockwise until the operation LED turns on (detecting the background) (turns off with dark ON type) (point B). (Note 1)
3		Set the middle point between point A and B as point C. (Note 2)

Note 1: When the background is far off and not detected, turn the control 360°, and set the point as point C.

Note 2: Because the control is multi-turn, it may take more than one turn to move from point A to point B.

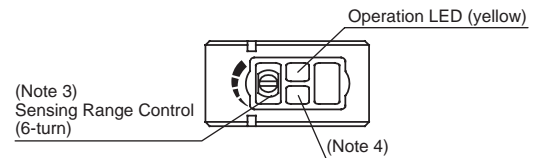

Note 3: Turning the control clockwise lengthens the sensing distance.

Note 4: Background suppression (BGS) type is not provided with a stable LED.

## 5. Power Supply and Wiring

- Do not use the SA1E photoelectric switch at the transient status immediately after turning on the power (approx. 100 ms, background suppression type: 200 ms). When the load and switch use different power supplies, make sure to power up the switch first.
- Use a power supply with little noise and inrush current, and use the photoelectric switch within the rated voltage range. Make sure that ripple factor is within the allowable limit. Do not apply AC voltage, otherwise the switch may blow out or burn.
- When using a switching power supply, make sure to ground the FG (frame ground) terminal, otherwise high-frequency noise may affect the photoelectric switch.
- Turn power off before inserting/removing the connector on photoelectric switch. Make sure that excessive mechanical force is not applied to the connector. Connect the connector cable to a tightening torque of 0.5 N·m maximum.
- To ensure the degree of protection, use the applicable connector cable for the connector type. Connector cables are ordered separately.
- Avoid parallel wiring with high-voltage or power lines in the same conduit, otherwise noise may cause malfunction and damage. When wiring is long, use a separate conduit for wiring.
- Use a cable of 0.3 mm<sup>2</sup> minimum core wires, then the cable can be extended up to 100m.

# SA1E Miniature Photoelectric Switches (Built-in Amplifier Type)

## 6. Installation

### Installing the Photoelectric Switch

- Do not install the SA1E photoelectric switches in an area where the switches are subject to the following conditions, otherwise malfunction and damage may be caused.
  - \* Inductive devices or heat source
  - \* Extreme vibration or shock
  - \* Large amount of dust
  - \* Toxic gases
  - \* Water, oil, chemicals
  - \* Outdoor
- Make sure to prevent sunlight, fluorescent light, and especially the fluorescent light of inverters from entering the receiver of the photoelectric switch directly. Keep the through-beam type receiver away from intense extraneous light.
- Interference prevention allows two SA1E switches to be mounted in close proximity. However, the through-beam type is not equipped with interference prevention. Maintain appropriate distance between the switches referring to the lateral displacement characteristics on pages 15 and 16.
- Because the SA1E photoelectric switches are IP67 waterproof, the SA1E can be exposed to water. However, wipe water drops and smears from the lens and slit using a soft cloth to make sure of the best detecting performance.
- Polycarbonate or acrylic resins are used for optical elements. Do not use ammonia or caustic soda for cleaning, otherwise optical elements will be dissolved. To remove dust and moisture build-up, use soft dry cloth.
- Tighten the mounting screws (M3) to a torque of 0.5 N·m. Do not tighten the mounting screws excessively or hit the switch with a hammer, otherwise the protection degree cannot be maintained.

### Installing the Reflector

- Use M4 mounting screws for the IAC-R5 reflector and M5 mounting screws for the IAC-R6 reflector. Tighten the mounting screws to a tightening torque of 0.5 N·m maximum. Mounting screws are not supplied with the switch.
- Use the M3 self-tapping screw, flat washer, and spring washer to tighten the IAC-R7 reflector to a torque of 0.5 to 0.6 N·m.
- While optional reflector mounting bracket IAC-L2 is not supplied with mounting screws or nuts, the IAC-L3 and IAC-L5 are supplied with mounting screws for mounting the reflector on the bracket.
- Reflector IAC-RS1 and IAC-RS2 can be installed directly on a flat surface using the adhesive tape attached to the back of the reflector. Before attaching the reflector, clean the board surface to ensure secure attachment.

### Installing the air blower mounting block SA9Z-A02

- When installing the SA9Z-A02 on the SA1E photoelectric switch, use the attached M3 × 20 mounting screws and tighten to a torque of 0.5 N·m maximum.
- Do not use the mounting screw (M3 × 12) supplied with the mounting bracket (SA9Z-K01) to mount the SA1E photoelectric switches.
- The SA9Z-A02 cannot be used with the through-beam slits (SA9Z-S06 to S14).
- The air tube fitting (M5) can be installed to either the top or side. The air tube is not supplied.
- Close the unused port using the supplied air supply port plugging screw and gasket to a tightening torque of 1 to 2 N·m maximum. The recommended air pressure is 0.1 to 0.3 MPa.

### Installing the background suppression (BGS) type

- This sensor can detect objects correctly when the sensor head is installed perpendicular to the moving object. Install the sensor head as shown below to minimize sensing errors.

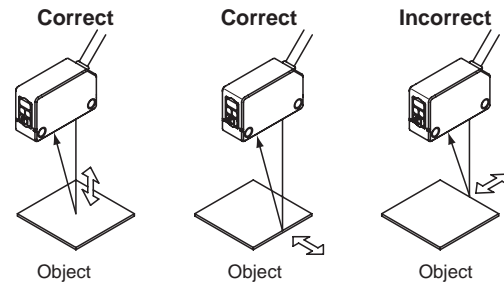

## Safety Precautions

Turn off power to the SA1E Miniature Photoelectric Switches before installation, removal, wiring, maintenance, and inspection. Failure to turn power off may cause electrical shock or fire hazard.

Specifications and other descriptions in this catalog are subject to change without notice.



## IDEC CORPORATION

**IDEC CORPORATION (USA)**  
1175 Elko Drive, Sunnyvale, CA 94089-2209, USA  
Tel: +1-408-747-0550 / (800) 262-IDEC (4332)  
Fax: +1-408-744-9055 / (800) 635-6246  
E-mail: opencontact@idec.com

**IDEC CANADA LIMITED**  
Unit 22-151, Brunel Road, Mississauga, Ontario,  
L4Z 1X3, Canada  
Tel: +1-905-890-8561, Toll Free: (888) 317-4332  
Fax: +1-905-890-8562  
E-mail: sales@ca.idec.com

**IDEC AUSTRALIA PTY. LTD.**  
2/3 Macro Court, Rowville, Victoria 3178, Australia  
Tel: +61-3-9763-3244, Toll Free: 1800-68-4332  
Fax: +61-3-9763-3255  
E-mail: sales@au.idec.com

**IDEC ELECTRONICS LIMITED**  
Unit 2, Beechwood, Chineham Business Park,  
Basingstoke, Hampshire RG24 8WA, UK  
Tel: +44-1256-321000, Fax: +44-1256-327755  
E-mail: sales@uk.idec.com

7-31, Nishi-Miyahara 1-Chome, Yodogawa-ku, Osaka 532-8550, Japan  
Tel: +81-6-6398-2571, Fax: +81-6-6392-9731  
E-mail: products@idec.co.jp

**IDEC ELEKTROTECHNIK GmbH**  
Wendenstrasse 331, 20537 Hamburg, Germany  
Tel: +49-40-25 30 54 - 0, Fax: +49-40-25 30 54 - 24  
E-mail: service@idec.de

**IDEC (SHANGHAI) CORPORATION**  
Room 608-609, 6F, Gangtai Plaza, No. 700,  
Yan'an East Road, Shanghai 200001, PRC  
Tel: +86-21-5353-1000, Fax: +86-21-5353-1263  
E-mail: idec@cn.idec.com

**IDEC (BEIJING) CORPORATION**  
Room 211B, Tower B, The Grand Pacific Building,  
8A Guanghua Road, Chaoyang District,  
Beijing 100026, PRC  
Tel: +86-10-6581-6131, Fax: +86-10-6581-5119

**IDEC (SHENZHEN) CORPORATION**  
Unit AB-3B2, Tian Xiang Building, Tian'an Cyber Park,  
Fu Tian District, Shenzhen, Guang Dong 518040, PRC  
Tel: +86-755-8356-2977, Fax: +86-755-8356-2944

**IDEC IZUMI (H.K.) CO., LTD.**  
Unit 1505-07, DCH Commercial Centre No. 25,  
Westlands Road, Quarry Bay, Hong Kong  
Tel: +852-2803-8989, Fax: +852-2565-0171  
E-mail: info@hk.idec.com

**IDEC TAIWAN CORPORATION**  
8F-1, No. 79, Hsin Tai Wu Road, Sec. 1,  
Hsi-Chih, Taipei County, Taiwan  
Tel: +886-2-2698-3929, Fax: +886-2-2698-3931  
E-mail: service@tw.idec.com

**IDEC IZUMI ASIA PTE. LTD.**  
No. 31, Tannery Lane #05-01, Dragon Land  
Building, Singapore 347788  
Tel: +65-6746-1155, Fax: +65-6844-5995  
E-mail: info@sg.idec.com