

Systema®

UBE:

Unterkonstruktionen für die verdeckte Befestigung großformatiger Fassadentafeln und Natursteinplatten mittels rückseitiger Agraffen.

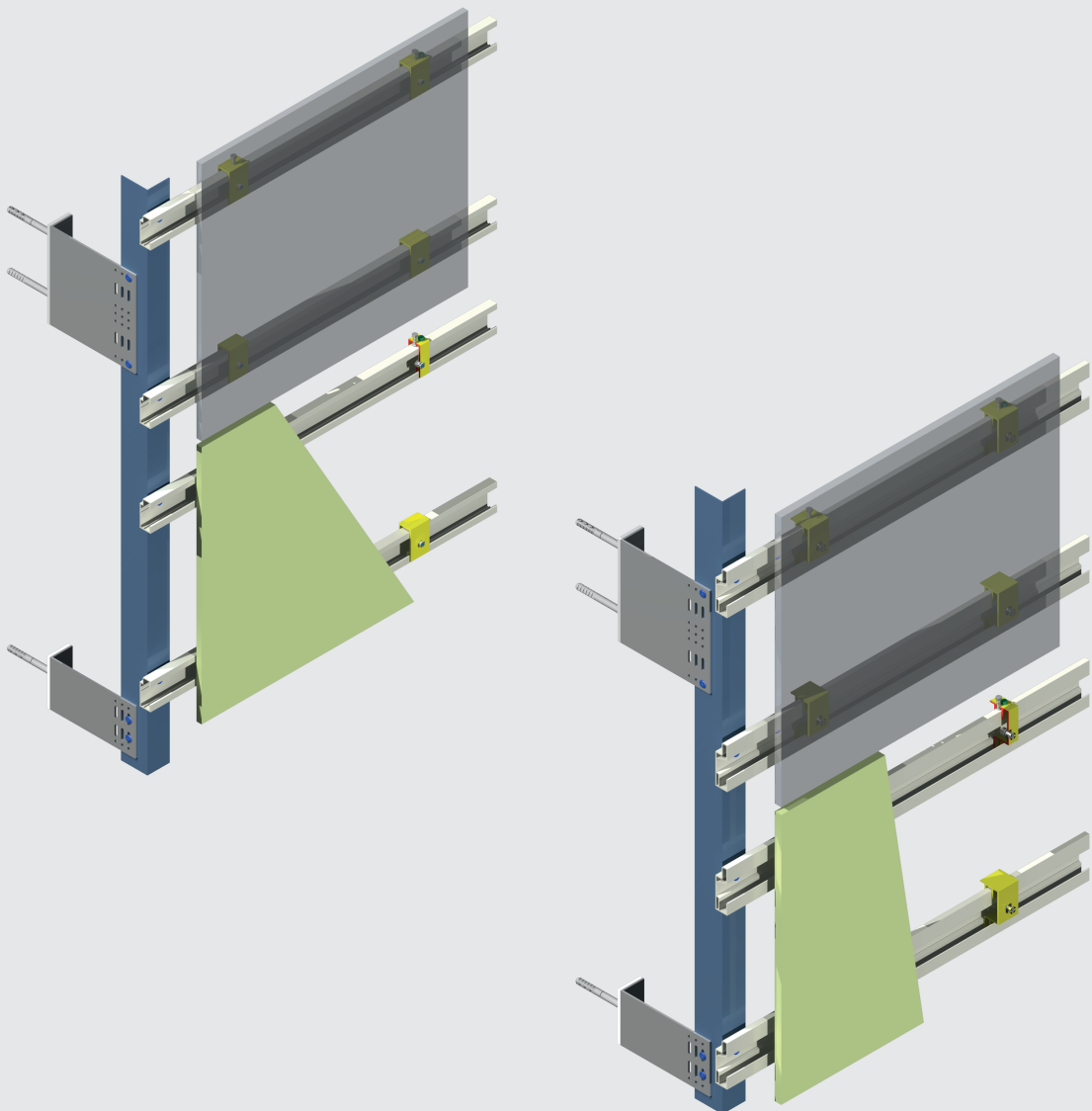

Systema®

UBE:

Unterkonstruktionen für ebene Fassadenplatten

12



UBE:

holding tracks for flat wall panels

UBE:

ossature pour des plaques façade lisse

UBE:
Unterkonstruktionen für ebene Fassadenplatten

UBE:
holding tracks for flat wall panels

UBE:
ossature pour des plaques façade lisse

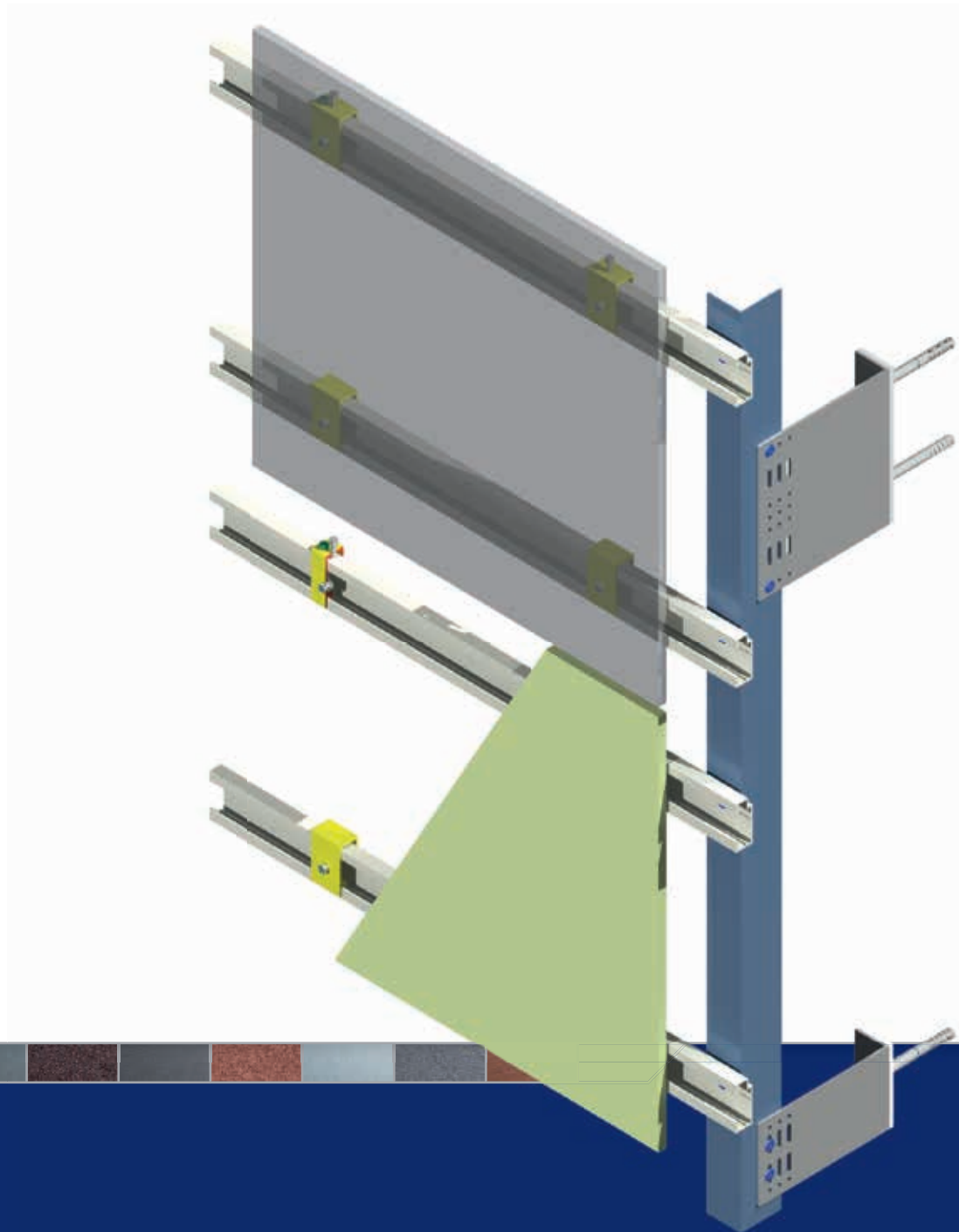

System: **UBE**
Unterkonstruktionen für ebene Fassadenplatten

System: **UBE**
holding tracks for flat wall panels

Systeme: **UBE**
ossature pour des plaques façade lisse

Seite page page			
12.02	Schnittübersicht	summery of sections	vue d'ensemble
12.03	Isometrie	isometric view	dessin isométrique
12.04	Schnitt horizontal	section horizontal	coupe horizontale
12.05	Schnitt vertikal	section vertical	coupe verticale
12.06	Innenecke	internal corner	coin intérieur
12.07	Außenecke stumpf gestoßen	external corner blunt	coin extérieur bout à bout
12.08	Außenecke mit negativem Winkel	external corner with negative angle	coin extérieur à angle négatif
12.09	Außenecke Vierkantprofil	external corner with square profile	coin extérieur avec profil carré
12.10	Fenstersturz	window lintel	linteau
12.11	Fensterlaibung	window recess	joue de fenêtre
12.12	Fensterbank	windowsill	bavette de fenêtre extérieure
12.13	Sockelabschluss	bottom closure	tôle basse de calfeutrement (raccord de socle)
12.14	Attikaabschluss	parapet	couvre-mur
12.15	Profilübersicht UBE	profile list UBE	ensemble de profil UBE

UBE

Schnittübersicht

summery of sections

vue d'ensemble

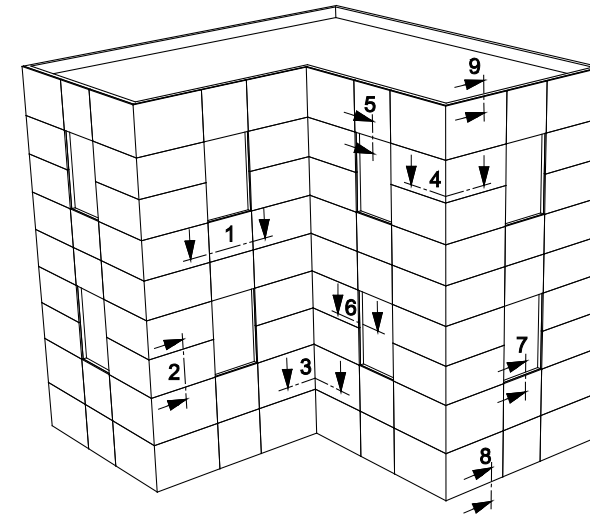

Schnitt 1: horizontal
Schnitt 2: vertikal
Schnitt 3: Innenecke
Schnitt 4: Außenecke
Schnitt 5: Fenstersturz
Schnitt 6: Fensterlaibung
Schnitt 7: Fensterbank
Schnitt 8: Sockelabschluss
Schnitt 9: Attikaabschluss

section 1: horizontal
section 2: vertical
section 3: internal corner
section 4: external corner
section 5: window lintel
section 6: window recess
section 7: windowsill
section 8: bottom closure
section 9: parapet

coupe 1: horizontale
coupe 2: verticale
coupe 3: coin intérieur
coupe 4: coin extérieur
coupe 5: linteau
coupe 6: joue de fenêtre
coupe 7: bavette de
fenêtre extérieure
coupe 8: tôle basse de
calfeutrement (raccord de
socle)
coupe 9: couvre-mur

UBE

Unterkonstruktionen für ebene Fassadenplatten

holding tracks for flat wall panels

ossature pour des plaques façade lisse

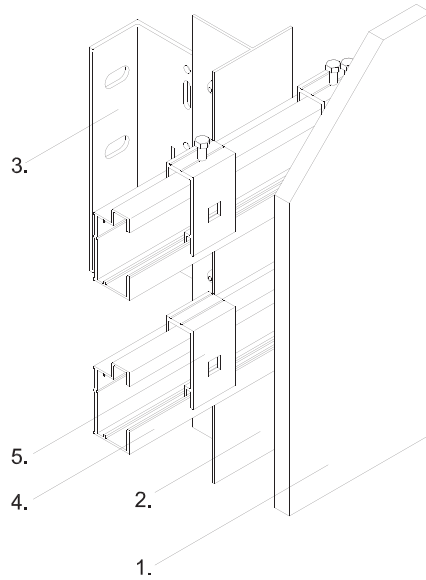

Agraffe/holding bracket/agrafe
Keil
Typ1 Typ2 Typ3

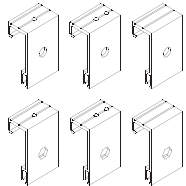

1. Fassadenbekleidung
2. senkrechtes Tragprofil
3. Systema L-Wandkonsole
4. Tragprofil UBE
5. Agraffe

Agraffe/holding bracket/agrafe
Tergo
Typ1 Typ2 Typ3

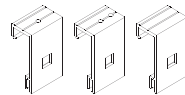

1. cladding panel
2. vertical holding track
3. Systema L-bracket
4. holding track UBE
5. agrafe

1. revêtement de façade
2. profil support vertical
3. équerre en L Systema
4. profil support UBE
5. agrafe

Schnitt 1 horizontal

Bekleidung: Keramik, Faserzement, Naturstein, Feinsteinzeug, HPL mit Hinterschnittbefestigung

section 1 horizontal

cladding: ceramic panels, fiber cement, natural stone, porcelain stoneware, HPL fixing with non-expanding anchor bolts

coupe 1 horizontale

revêtement de façade: céramique, ciment fibre, pierre naturelle, grès cérame fin vitrifié, HPL à fixation antérieure

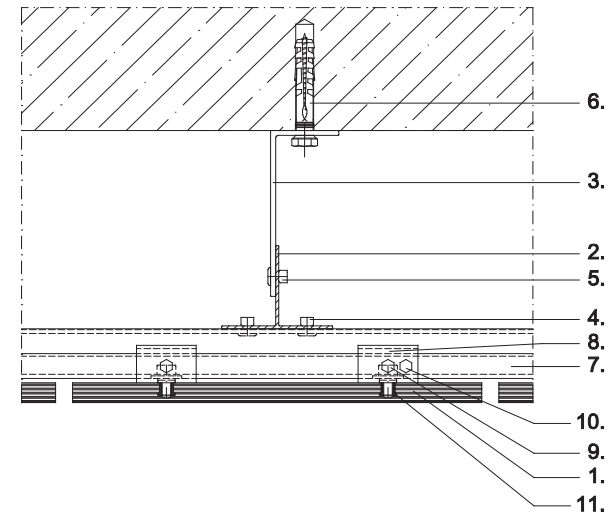

1. Fassadenbekleidung
2. senkrechtes Tragprofil
3. Systema L-Wandkonsole
4. Befestigungsniel
5. Verbindungsniel
6. Verankerung
7. Tragprofil
8. Agraffe
9. Justierschraube
10. Feststellschraube
11. Hinterschnittdübel

1. cladding panel
2. vertical holding track
3. Systema L-bracket
4. fixing rivet
5. connecting rivet
6. fixing
7. holding track
8. holding bracket
9. adjustment screw
10. locking screw
11. non-expanding anchor bolt

1. revêtement de façade
2. profil support vertical
3. équerre en L Systema
4. rivet de fixation
5. jonction
6. ancrage
7. profil support
8. agrafe
9. vis de réglage
10. vis de serrage
11. cheville antérieure

Schnitt 2 vertikal

Bekleidung: Keramik,
Faserzement, Naturstein,
Feinsteinzeug, HPL mit
Hinterschnittbefestigung

section 2 vertical

cladding: ceramic panels,
fiber cement, natural stone,
porcelain stoneware, HPL
fixing with non-expanding
achor bolts

coupe 2 verticale

revêtement de façade:
céramique, ciment fibre,
pierre naturelle, grès cérame
fin vitrifié, HPL à fixation
antérieure

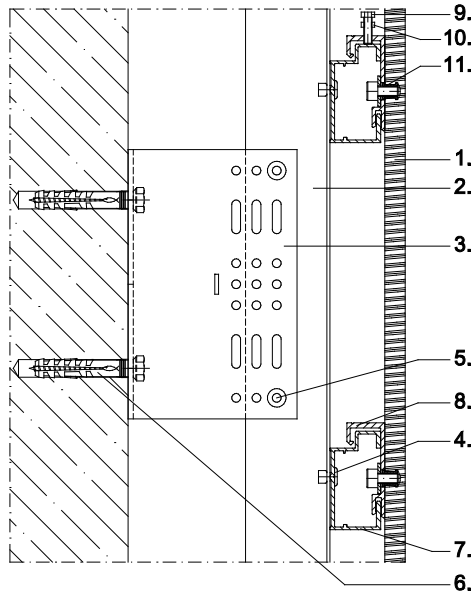

- | | | |
|---------------------------|-------------------------------|----------------------------|
| 1. Fassadenbekleidung | 1. cladding panel | 1. revêtement de façade |
| 2. senkrechtes Tragprofil | 2. vertical holding track | 2. profil support vertical |
| 3. Systema L-Wandkonsole | 3. Systema L-bracket | 3. équerre en L Systema |
| 4. Befestigungsniel | 4. fixing rivet | 4. rivet de fixation |
| 5. Verbindungsniel | 5. connecting rivet | 5. jonction |
| 6. Verankerung | 6. fixing | 6. ancrage |
| 7. Tragprofil | 7. holding track | 7. profil support |
| 8. Agraffe | 8. holding bracket | 8. agrafe |
| 9. Justierschraube | 9. adjustment screw | 9. vis de réglage |
| 10. Feststellschraube | 10. locking screw | 10. vis de serrage |
| 11. Hinterschnittdübel | 11. non-expanding anchor bolt | 11. cheville antérieure |

Schnitt 3 Innenecke

Bekleidung: Keramik,
Faserzement, Naturstein,
Feinsteinzeug, HPL mit
Hinterschnittbefestigung

section 3 internal corner

cladding: ceramic panels,
fiber cement, natural stone,
porcelain stoneware, HPL
fixing with non-expanding
achor bolts

coupe 3 coin intérieur

revêtement de façade:
céramique, ciment fibre,
pierre naturelle, grès cérame
fin vitrifié, HPL à fixation
antérieure

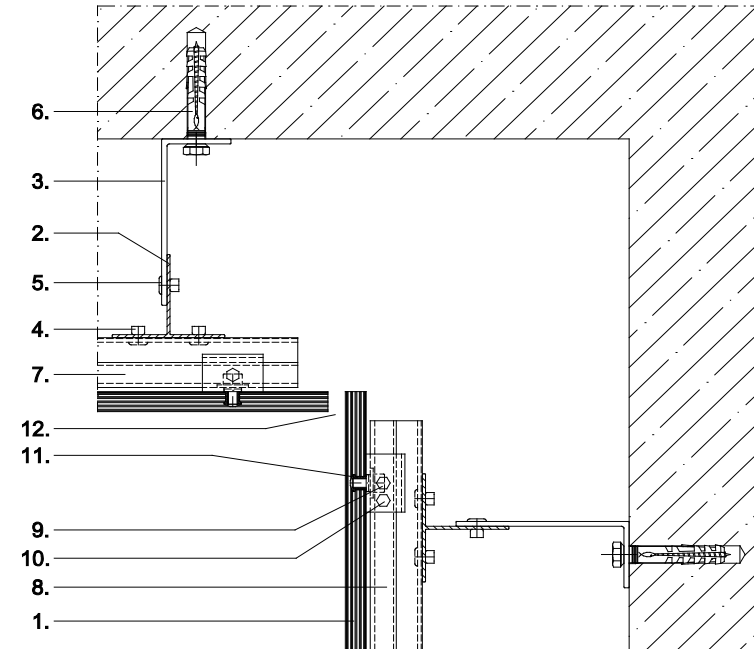

- | | | |
|------------------------------------|----------------------------------|------------------------------------|
| 1. Fassadenbekleidung | 1. cladding panel | 1. revêtement de façade |
| 2. senkrechtes Tragprofil | 2. vertical holding track | 2. profil support vertical |
| 3. Systema L-Wandkonsole | 3. Systema L-bracket | 3. équerre en L Systema |
| 4. Befestigungsniel | 4. fixing rivet | 4. rivet de fixation |
| 5. Verbindungsniel | 5. connecting rivet | 5. jonction |
| 6. Verankerung | 6. fixing | 6. ancrage |
| 7. Tragprofil | 7. holding track | 7. profil support |
| 8. Agraffe | 8. holding bracket | 8. agrafe |
| 9. Justierschraube | 9. adjustment screw | 9. vis de réglage |
| 10. Feststellschraube | 10. locking screw | 10. vis de serrage |
| 11. Hinterschnittdübel
gestoßen | 11. non-expanding anchor
bolt | 11. cheville antérieure |
| 12. Innenecke stumpf
gestoßen | 12. internal corner, blunt | 12. coin intérieure
bout à bout |

Schnitt 4 Außenecke stumpf gestoßen

Bekleidung: Keramik,
Faserzement, Naturstein,
Feinsteinzeug, HPL mit
Hinterschnittbefestigung

section 4 external corner blunt

cladding: ceramic panels,
fiber cement, natural stone,
porcelaine stoneware, HPL
fixing with non-expanding
achor bolts

coupe 4 coin extérieur bout à bout

revêtement de façade:
céramique, ciment fibre,
pierre naturelle, grès cérame
fixing with non-expanding
antérieure

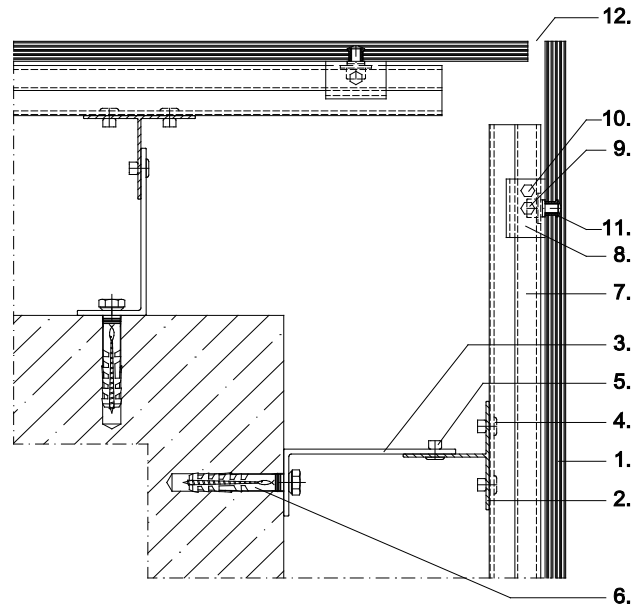

1. Fassadenbekleidung
2. senkrechtes Tragprofil
3. Systema L-Wandkonsole
4. Befestigungsniel
5. Verbindungsniel
6. Verankerung
7. Tragprofil
8. Agraffe
9. Justierschraube
10. Feststellschraube
11. Hinterschnittdübel
12. Außenecke stumpf gestoßen

1. cladding panel
2. vertical holding track
3. Systema L-bracket
4. fixing rivet
5. connecting rivet
6. fixing
7. holding track
8. holding bracket
9. adjustment screw
10. locking screw
11. non-expanding anchor bolt
12. external corner, blunt

1. revêtement de façade
2. profil support vertical
3. équerre en L Systema
4. rivet de fixation
5. jonction
6. ancrage
7. profil support
8. agrafe
9. vis de réglage
10. vis de serrage
11. cheville antérieure
12. coin extérieur bout à bout

Schnitt 4 Außenecke mit negativem Winkel

Bekleidung: Keramik,
Faserzement, Naturstein,
Feinsteinzeug, HPL mit
Hinterschnittbefestigung

section 4 external corner with negative angle

cladding: ceramic panels,
fiber cement, natural stone,
porcelaine stoneware, HPL
fixing with non-expanding
achor bolts

coupe 4 coin extérieur à angle négatif

revêtement de façade:
céramique, ciment fibre,
pierre naturelle, grès cérame
fixing with non-expanding
antérieure

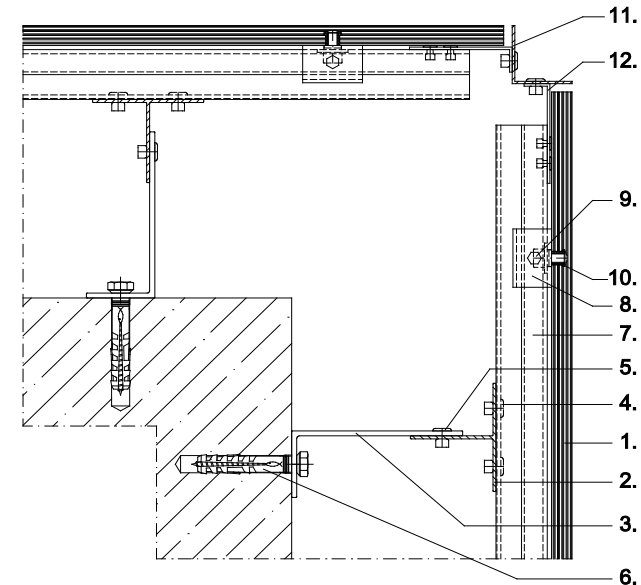

1. Fassadenbekleidung
2. senkrechtes Tragprofil
3. Systema L-Wandkonsole
4. Befestigungsniel
5. Verbindungsniel
6. Verankerung
7. Tragprofil
8. Agraffe
9. Justierschraube
10. Feststellschraube
11. Hinterschnittdübel
12. Außenecke mit
Negativausbildung
13. Winkelprofil

1. cladding panel
2. vertical holding track
3. Systema L-bracket
4. fixing rivet
5. connecting rivet
6. fixing
7. holding track
8. holding bracket
9. adjustment screw
10. locking screw
11. non-expanding anchor bolt
12. external corner with
negative angle
13. angle profile

1. revêtement de façade
2. profil support vertical
3. équerre en L Systema
4. rivet de fixation
5. jonction
6. ancrage
7. profil support
8. agrafe
9. vis de réglage
10. vis de serrage
11. cheville antérieure
12. profil extérieur
à configuration négative
13. profil d'équerre

Schnitt 4 Außenecke mit Vierkantprofil

Bekleidung: Keramik,
Faserzement, Naturstein,
Feinsteinzeug, HPL mit
Hinterschnittbefestigung

section 4 external corner with square profile

cladding: ceramic panels,
fiber cement, natural stone,
porcelaine stoneware, HPL
fixing with non-expanding
achor bolts

coupe 4 coin extérieur avec profil carré

revêtement de façade:
céramique, ciment fibre,
pierre naturelle, grès cérame
fin vitrifié, HPL à fixation
antérieure

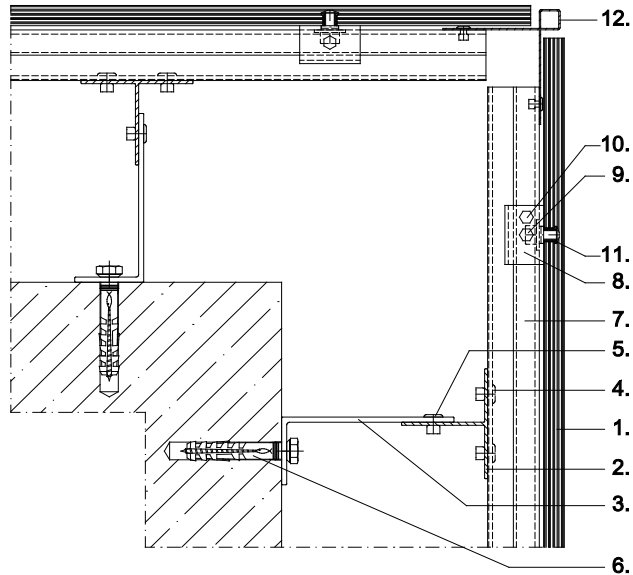

- | | | |
|----------------------------------|---|--------------------------------------|
| 1. Fassadenbekleidung | 1. cladding panel | 1. revêtement de façade |
| 2. senkrechtes Tragprofil | 2. vertical holding track | 2. profil support vertical |
| 3. Systema L-Wandkonsole | 3. Systema L-bracket | 3. équerre en L Systema |
| 4. Befestigungsriem | 4. fixing rivet | 4. rivet de fixation |
| 5. Verbindungsriem | 5. connecting rivet | 5. jonction |
| 6. Verankerung | 6. fixing | 6. ancrage |
| 7. Tragprofil | 7. holding track | 7. profil support |
| 8. Agraffe | 8. holding bracket | 8. agrafe |
| 9. Justierschraube | 9. adjustment screw | 9. vis de réglage |
| 10. Feststellschraube | 10. locking screw | 10. vis de serrage |
| 11. Hinterschnittdübel | 11. non-expanding anchor bolt | 11. cheville antérieure |
| 12. Außenecke mit Vierkantprofil | 12. external corner with square profile | 12. coin extérieur avec profil carré |

Schnitt 5 Fenstersturz

Bekleidung: Keramik,
Faserzement, Naturstein,
Feinsteinzeug, HPL mit
Hinterschnittbefestigung

section 5 window lintel

cladding: ceramic panels,
fiber cement, natural stone,
porcelaine stoneware, HPL
fixing with non-expanding
achor bolts

coupe 5 linteau

revêtement de façade:
céramique, ciment fibre,
pierre naturelle, grès cérame
fin vitrifié, HPL à fixation
antérieure

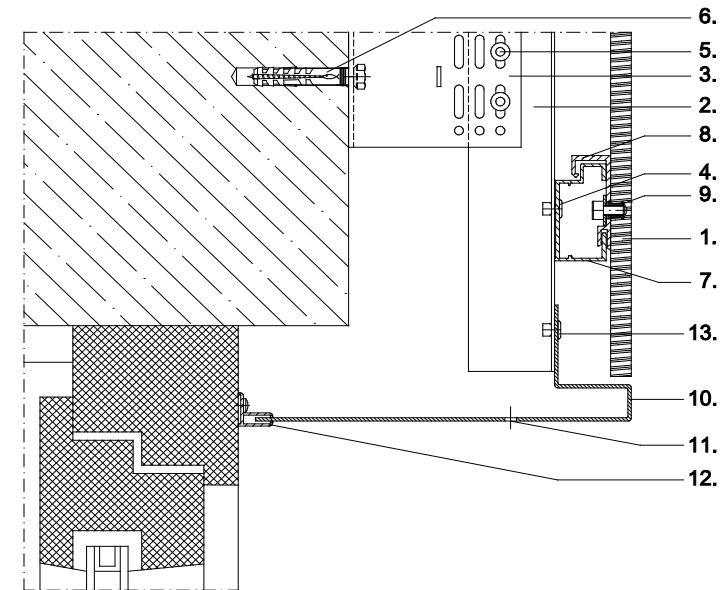

- | | | |
|------------------------------|------------------------------|---------------------------------|
| 1. Fassadenbekleidung | 1. cladding panel | 1. revêtement de façade |
| 2. senkrechtes Tragprofil | 2. vertical holding track | 2. profil support vertical |
| 3. Systema L-Wandkonsole | 3. Systema L-bracket | 3. équerre en L Systema |
| 4. Befestigungsriem | 4. fixing rivet | 4. rivet de fixation |
| 5. Verbindungsriem | 5. connecting rivet | 5. jonction |
| 6. Verankerung | 6. fixing | 6. ancrage |
| 7. Tragprofil | 7. holding track | 7. profil support |
| 8. Agraffe | 8. holding bracket | 8. agrafe |
| 9. Hinterschnittdübel | 9. non-expanding anchor bolt | 9. cheville antérieure |
| 10. Fensterzarge | 10. window frame | 10. châssis |
| 11. Belüftungsöffnung | 11. ventilation opening | 11. ventilation |
| 12. Systema Stimmgabelprofil | 12. Systema F-profile | 12. profil F Systema (diapason) |
| 13. Befestigungselement | 13. fixing element | 13. élément de fixation |

Schnitt 6 Fensterlaibung

Bekleidung: Keramik,
Faserzement, Naturstein,
Feinsteinzeug, HPL mit
Hinterschnittbefestigung

section 6 window recess

cladding: ceramic panels,
fiber cement, natural stone,
porcelain stoneware, HPL
fixing with non-expanding
achor bolts

coupe 6 joue de fenêtre

revêtement de façade:
céramique, ciment fibre,
pierre naturelle, grès cérame
fin vitrifié, HPL à fixation
antérieure

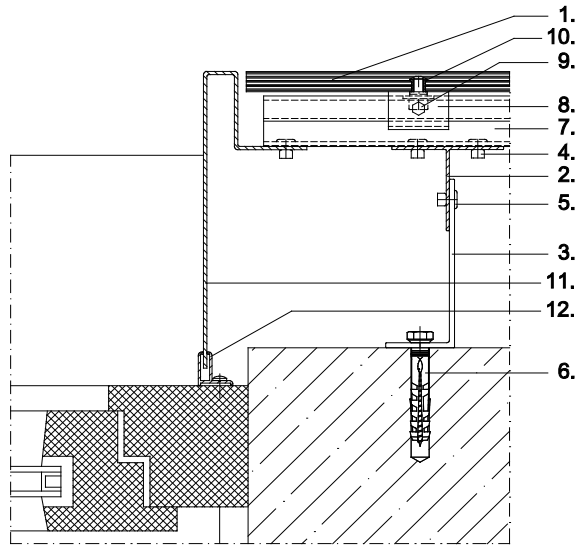

1. Fassadenbekleidung
2. senkrechtes Tragprofil
3. Systema L-Wandkonsole
4. Befestigungsriem
5. Verbindungsriem
6. Verankerung
7. Tragprofil
8. Agraffe
9. Justierschraube
10. Hinterschnittdübel
11. Fensterzarge
12. Systema Stimmgabelprofil

1. cladding panel
2. vertical holding track
3. Systema L-bracket
4. fixing rivet
5. connecting rivet
6. fixing
7. holding track
8. holding bracket
9. adjustment screw
10. non-expanding anchor bolt
11. window frame
12. Systema F-profile

1. revêtement de façade
2. profil support vertical
3. équerre en L Systema
4. rivet de fixation
5. jonction
6. ancrage
7. profil support
8. agrafe
9. vis de réglage
10. cheville antérieure
11. châssis
12. profil F Systema (diapason)

Schnitt 7 Fensterbank

Bekleidung: Keramik,
Faserzement, Naturstein,
Feinsteinzeug, HPL mit
Hinterschnittbefestigung

section 7 windowsill

cladding: ceramic panels,
fiber cement, natural stone,
porcelain stoneware, HPL
fixing with non-expanding
achor bolts

coupe 7 bavette de fenêtre extérieure

revêtement de façade:
céramique, ciment fibre,
pierre naturelle, grès cérame
fin vitrifié, HPL à fixation
antérieure

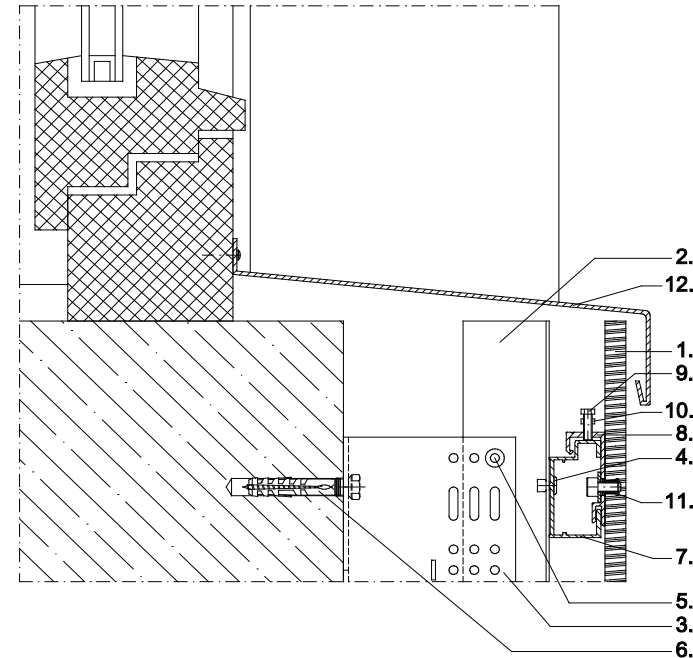

1. Fassadenbekleidung
2. senkrechtes Tragprofil
3. Systema L-Wandkonsole
4. Befestigungsriem
5. Verbindungsriem
6. Verankerung
7. Tragprofil
8. Agraffe
9. Justierschraube
10. Feststellschraube
11. Hinterschnittdübel
12. Systema Fensterbank

1. cladding panel
2. vertical holding track
3. Systema L-bracket
4. fixing rivet
5. connecting rivet
6. fixing
7. holding track
8. holding bracket
9. adjustment screw
10. locking screw
11. non-expanding anchor bolt
12. Systema windowsill

1. revêtement de façade
2. profil support vertical
3. équerre en L Systema
4. rivet de fixation
5. jonction
6. ancrage
7. profil support
8. agrafe
9. vis de réglage
10. vis de serrage
11. cheville antérieure
12. bavette Systema

Schnitt 8 Sockelabschluss

Bekleidung: Keramik,
Faserzement, Naturstein,
Feinsteinzeug, HPL mit
Hinterschnittbefestigung

section 8 bottom closure

cladding: ceramic panels,
fiber cement, natural stone,
porcelaine stoneware, HPL
fixing with non-expanding
achor bolts

coupe 8 tôle basse de calfeutrement (raccord de socle)

revêtement de façade:
céramique, ciment fibre,
pierre naturelle, grès cérame
fin vitrifié, HPL à fixation
antérieure

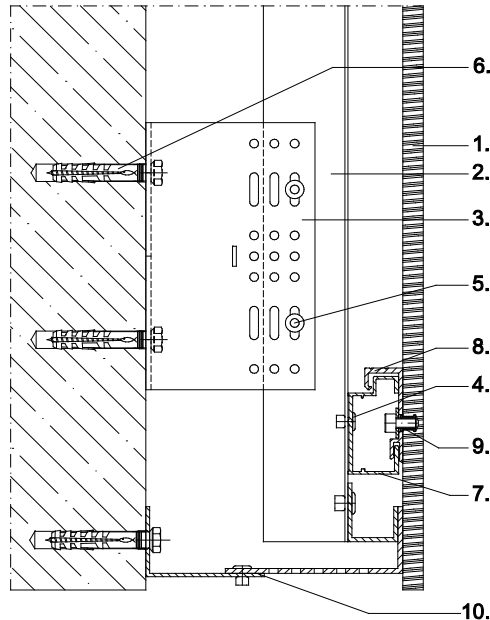

1. Fassadenbekleidung
2. senkrechtes Tragprofil
3. Systema L-Wandkonsole
4. Befestigungsniel
5. Verbindungsniel
6. Verankerung
7. Tragprofil
8. Agraffe
9. Hinterschnittdübel
10. Abschlusswinkel mit Belüftung

1. cladding panel
2. vertical holding track
3. Systema L-bracket
4. fixing rivet
5. connecting rivet
6. fixing
7. holding track
8. agraffe
9. non-expanding anchor bolt
10. ventilated angle

1. revêtement de façade
2. profil support vertical
3. équerre en L Systema
4. rivet de fixation
5. jonction
6. ancrage
7. profil support
8. agrafe
9. cheville antérieure
10. angle pour ventilation

Schnitt 9 Attikaabschluss

Bekleidung: Keramik,
Faserzement, Naturstein,
Feinsteinzeug, HPL mit
Hinterschnittbefestigung

section 9 parapet

cladding: ceramic panels,
fiber cement, natural stone,
porcelaine stoneware, HPL
fixing with non-expanding
achor bolts

coupe 9 couvre-mur

revêtement de façade:
céramique, ciment fibre,
pierre naturelle, grès cérame
fin vitrifié, HPL à fixation
antérieure

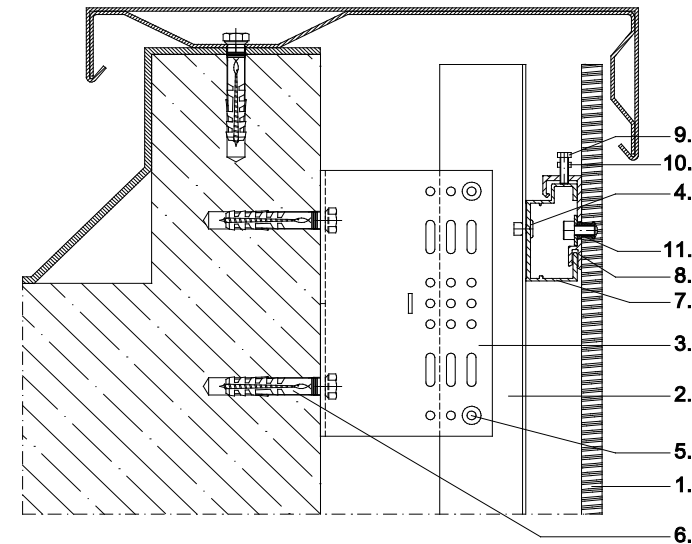

1. Fassadenbekleidung
2. senkrechtes Tragprofil
3. Systema L-Wandkonsole
4. Befestigungsniel
5. Verbindungsniel
6. Verankerung
7. Tragprofil
8. Agraffe
9. Justierschraube
10. Feststellschraube
11. Hinterschnittdübel

1. cladding panel
2. vertical holding track
3. Systema L-bracket
4. fixing rivet
5. connecting rivet
6. fixing
7. holding track
8. holding bracket
9. adjustment screw
10. locking screw
11. non-expanding anchor bolt

1. revêtement de façade
2. profil support vertical
3. équerre en L Systema
4. rivet de fixation
5. jonction
6. ancrage
7. profil support
8. agrafe
9. vis de réglage
10. vis de serrage
11. cheville antérieure

Inhaltsverzeichnis Profilübersicht UBE
 Contents profile list UBE
 Index ensemble de profil UBE

Seite page page	Profile	profiles	profilés
12.16	vertikale Tragprofile T-Profil 40/55 T-Profil 65/50 Wanddicke 2mm	vertical holding tracks T-profile 40/55 T-profile 65/50 wall thickness 2mm	rails porteurs verticaux profil T 40/55 profil T 65/50 épaisseur du mur 2mm
12.17	Systemprofile UBE Tragprofil UBE 25/2 Tragprofil UBE 25/2 "S" Agraffe für UBE 25/2	system profiles UBE holding track UBE 25/2 holding track UBE 25/2 "S" holding bracket for UBE 25/2	profilés de système UBE profil support UBE 25/2 profil support UBE 25/2 "S" agrafe pour UBE 25/2
12.18	Tragprofil UBE 25 für Tergo Tragprofil UBE 25/2 "S" für Tergo Agraffe für UBE 25 Tergo	holding track UBE 25 for Tergo holding track UBE 25/2 "S" for Tergo holding bracket for UBE 25 Tergo	profil support UBE 25 pour Tergo profil support UBE 25 "S" pour Tergo agrafe pour UBE 25 Tergo
12.19	L-Wandkonsolen WB 0 - 85/160/250mm	L-brackets WB 0 - 85/160/250mm	équerres en L WB 0 - 85/160/250mm
12.20	WB 1-6 - 85/160/250mm	WB 1-6 - 85/160/250mm	WB 1-6 - 85/160/250mm
12.21	WB 7-9,5 - 85/160/250	WB 7-9,5 - 85/160/250	WB 7-9,5 - 85/160/250
12.22	WB 10-14 - 85/160/250mm	WB 10-14 - 85/160/250mm	WB 10-14 - 85/160/250mm

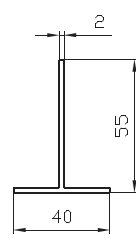
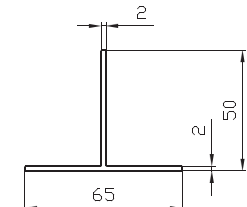
Profiltyp profile type type de profil	Länge (mm) length (mm) longueur (mm)	Material material matériel	Einzelpreis unit price prix unitaire
 <p>T-Profil 40/55 T-profile 40/55 profile T 40/55</p>	5600 6000	EN AW 6063 T66	
 <p>T-Profil 65/50 Wanddicke 2mm T-profile 65/50 wall thickness 2mm profile T 65/50 épaisseur du mur 2mm</p>	5600 6000	EN AW 6063 T66	

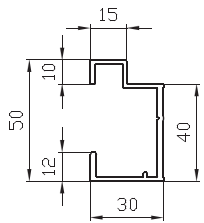
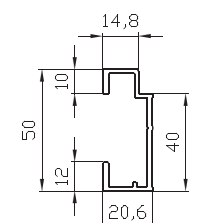
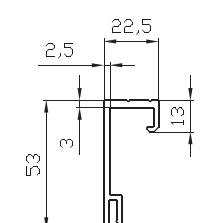
Profiltyp profile type type de profil	Länge (mm) length (mm) longueur (mm)	Material material matériel	Einzelpreis unit price prix unitaire
 <p>Tragprofil UBE 25/2 holding track UBE 25/2 profil support UBE 25/2</p>	6000	EN AW 6063 T66	
 <p>Tragprofil UBE 25/2 "S" holding track UBE 25/2 "S" profil support UBE 25/2 "S"</p>	6000	EN AW 6063 T66	
 <p>Agraffe für UBE 25/2 holding bracket for UBE 25/2 agrafe pour UBE 25/2</p>	Typ 1 Typ 2 Typ 3	EN AW 6063 T66	

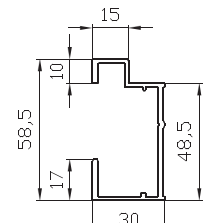
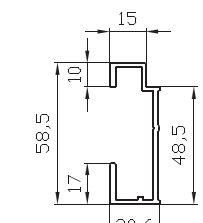
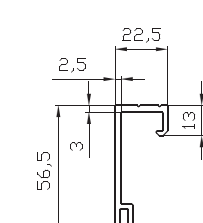
Profiltyp profile type type de profil	Länge (mm) length (mm) longueur (mm)	Material material matériel	Einzelpreis unit price prix unitaire
 <p>Tragprofil UBE 25 für Tergo holding track UBE 25 for Tergo profil support UBE 25 pour Tergo</p>	6000	EN AW 6063 T66	
 <p>Tragprofil UBE 25 "S" für Tergo holding track UBE 25 "S" for Tergo profil support UBE 25 "S" pour Tergo</p>	6000	EN AW 6063 T66	
 <p>Agraffe für UBE 25 Tergo holding bracket for UBE 25 Tergo agrafe pour UBE 25 Tergo</p>	Typ 1 Typ 2 Typ 3	EN AW 6063 T66	

Profiltyp profile type type de profil	Länge (mm) length (mm) longueur (mm)	Material material matériau	Einzelpreis unit price prix unitaire
	WB0 40/40/3-85	EN AW 6063 T66	
	WB0 40/40/3-160	EN AW 6063 T66	
	WB0 40/40/3-250	EN AW 6063 T66	
WB0 40/40/3 - 85/160/250mm			

Profiltyp profile type type de profil	Länge (mm) length (mm) longueur (mm)	Material material matériau	Einzelpreis unit price prix unitaire
	WB1 40/60/3-85 WB2 40/80/3-85 WB3 40/100/3-85 WB4 40/120/3-85 WB5 40/140/3-85 WB6 40/160/3-85	EN AW 6063 T66	
	WB1 40/60/3-160 WB2 40/80/3-160 WB3 40/100/3-160 WB4 40/120/3-160 WB5 40/140/3-160 WB6 40/160/3-160	EN AW 6063 T66	
	WB1 40/60/3-250 WB2 40/80/3-250 WB3 40/100/3-250 WB4 40/120/3-250 WB5 40/140/3-250 WB6 40/160/3-250	EN AW 6063 T66	
WB 1-6 - 85/160/250mm			

L-Wandkonsole L-bracket équerre en L	Länge L length L longueur L
WB1	60 mm
WB2	80 mm
WB3	100 mm
WB4	120 mm
WB5	140 mm
WB6	160 mm

Profiltyp profile type type de profil	Länge (mm) length (mm) longueur (mm)	Material material matériau	Einzelpreis unit price prix unitaire												
	WB7 40/180/4/3-85 WB8 40/200/4/3-85 WB8,5 40/210/4/3-85 WB9 40/220/4/3-85 WB9,5 40/230/4/3-85	EN AW 6063 T66													
	WB7 40/180/4/3-160 WB8 40/200/4/3-160 WB8,5 40/210/4/3-160 WB9 40/220/4/3-160 WB9,5 40/230/4/3-160	EN AW 6063 T66													
	WB7 40/180/4/3-250 WB8 40/200/4/3-250 WB8,5 40/210/4/3-250 WB9 40/220/4/3-250 WB9,5 40/230/4/3-250	EN AW 6063 T66													
	<table border="1"> <thead> <tr> <th>L-Wandkonsole L-bracket équerre en L</th> <th>Länge L length L longueur L</th> </tr> </thead> <tbody> <tr> <td>WB7</td> <td>180 mm</td> </tr> <tr> <td>WB8</td> <td>200 mm</td> </tr> <tr> <td>WB8,5</td> <td>210 mm</td> </tr> <tr> <td>WB9</td> <td>220 mm</td> </tr> <tr> <td>WB9,5</td> <td>230 mm</td> </tr> </tbody> </table>			L-Wandkonsole L-bracket équerre en L	Länge L length L longueur L	WB7	180 mm	WB8	200 mm	WB8,5	210 mm	WB9	220 mm	WB9,5	230 mm
	L-Wandkonsole L-bracket équerre en L	Länge L length L longueur L													
	WB7	180 mm													
	WB8	200 mm													
	WB8,5	210 mm													
	WB9	220 mm													
	WB9,5	230 mm													
	WB7-9,5 - 85/160/250mm														

Profiltyp profile type type de profil	Länge (mm) length (mm) longueur (mm)	Material material matériau	Einzelpreis unit price prix unitaire												
	WB10 43/240/4/3-85 WB11 43/260/4/3-85 WB12 43/280/4/3-85 WB13 43/300/4/3-85 WB14 43/320/4/3-85	EN AW 6063 T66													
	WB10 43/240/4/3-160 WB11 43/260/4/3-160 WB12 43/280/4/3-160 WB13 43/300/4/3-160 WB14 43/320/4/3-160	EN AW 6063 T66													
	WB10 43/240/4/3-250 WB11 43/260/4/3-250 WB12 43/280/4/3-250 WB13 43/300/4/3-250 WB14 43/320/4/3-250	EN AW 6063 T66													
	<table border="1"> <thead> <tr> <th>L-Wandkonsole L-bracket équerre en L</th> <th>Länge L length L longueur L</th> </tr> </thead> <tbody> <tr> <td>WB10</td> <td>240 mm</td> </tr> <tr> <td>WB11</td> <td>260 mm</td> </tr> <tr> <td>WB12</td> <td>280 mm</td> </tr> <tr> <td>WB13</td> <td>300 mm</td> </tr> <tr> <td>WB14</td> <td>320 mm</td> </tr> </tbody> </table>			L-Wandkonsole L-bracket équerre en L	Länge L length L longueur L	WB10	240 mm	WB11	260 mm	WB12	280 mm	WB13	300 mm	WB14	320 mm
	L-Wandkonsole L-bracket équerre en L	Länge L length L longueur L													
	WB10	240 mm													
	WB11	260 mm													
	WB12	280 mm													
	WB13	300 mm													
	WB14	320 mm													
	WB10-14 - 85/160/250mm														

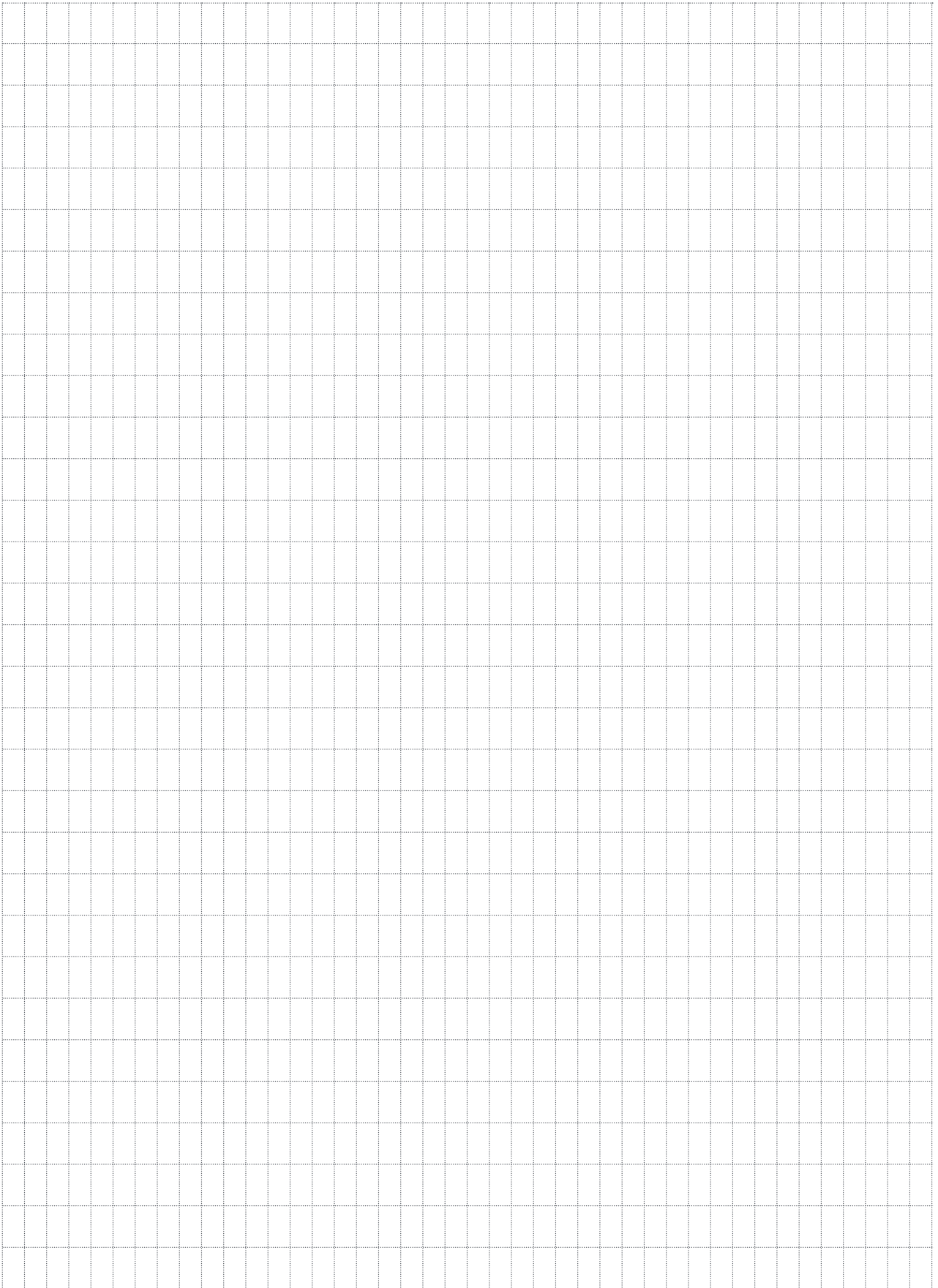



Systema®

Systema Pohl GmbH

Margarete-Steiff-Str. 6
D-24558 Henstedt-Ulzburg
Deutschland / Germany

Fon: +49 (0) 41 93 / 99 11-0
Fax: +49 (0) 41 93 / 99 11-49

info@systema.systems
www.systema.systems



Bitte besuchen Sie uns für weitere
technische Informationen und
eine Vielzahl von Referenzen
im Internet: www.systema.systems

Ein Unternehmen der
POHL-Gruppe

UBE NG2:

Unterkonstruktionen für ebene Fassadenplatten

UBE für Naturstein

13



UBE NG2:

holding tracks for flat wall panels

UBE for natural stone

UBE NG2:

ossature pour des plaques façade lisse

UBE pour pierre naturelle

UBE NG2:
Unterkonstruktionen für ebene Fassadenplatten
UBE für Naturstein

UBE NG2:
holding tracks for flat wall panels
UBE for natural stone

UBE NG2:
ossature pour des plaques façade lisse
UBE pour pierre naturelle

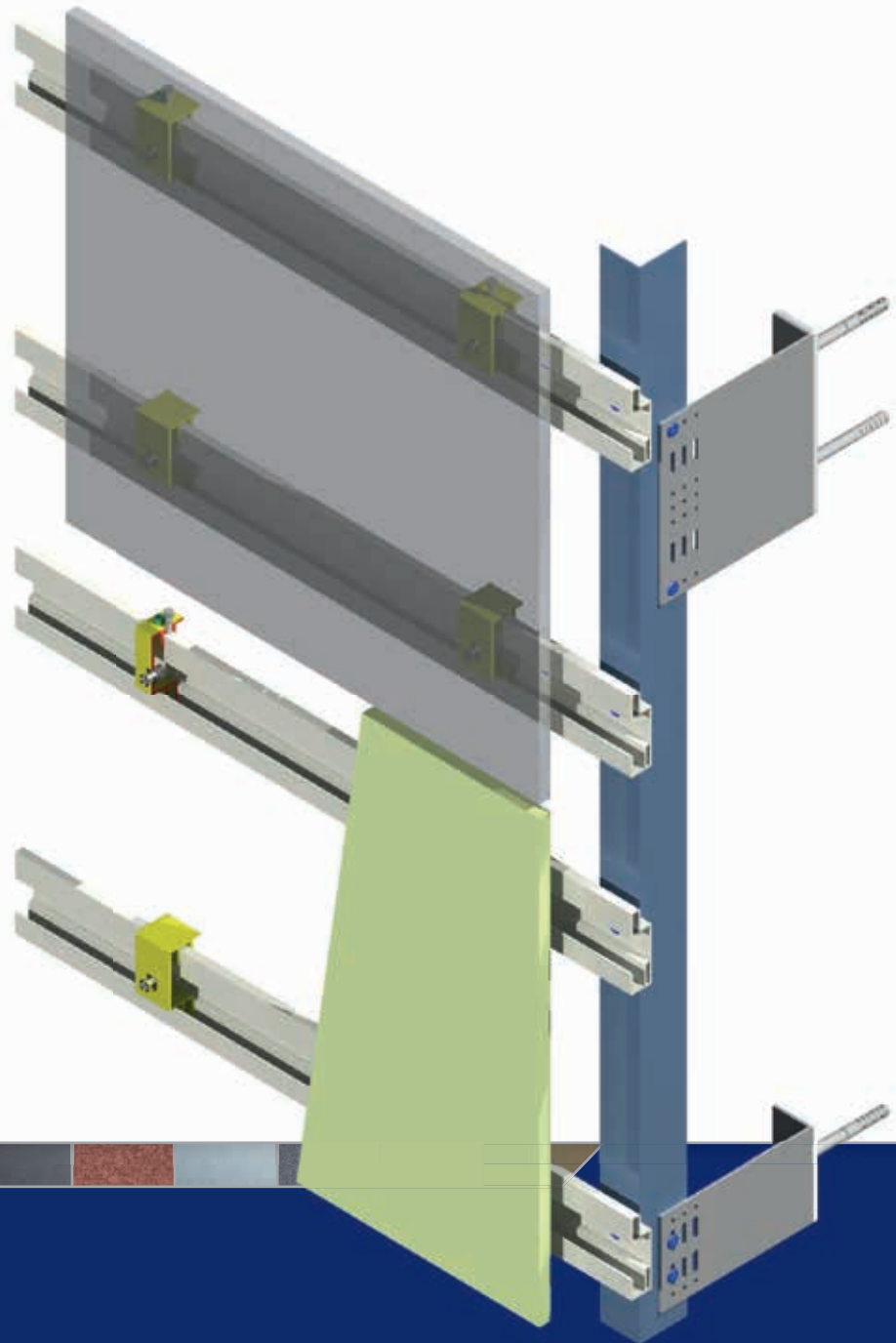

System: **UBE NG2** Unterkonstruktionen für ebene Fassadenplatten
UBE für Naturstein

System: **UBE NG2** holding tracks for flat wall panels
UBE for natural stone

Système: **UBE NG2** ossature pour des plaques façade lisse
UBE pour pierre naturelle

Seite
page
page

	UBE NG2 ossature pour des plaques façade lisse		
13.02	Schnittübersicht	summery of sections	vue d'ensemble
13.03	Isometrie	isometric view	dessin isométrique
13.04	Schnitt horizontal	section horizontal	coupe horizontale
13.05	Schnitt vertikal	section vertical	coupe verticale
13.06	Innenecke	internal corner	coin intérieur
13.07	Außenecke stumpf gestoßen	external corner blunt	coin extérieur bout à bout
13.08	Außenecke mit negativem Winkel	external corner with negative angle	coin extérieur à angle négatif
13.09	Fenstersturz	window lintel	linteau
13.10	Fensterlaibung	window recess	joue de fenêtre
13.11	Fensterbank	windowsill	bavette de fenêtre extérieure
13.12	Sockelabschluss	bottom closure	tôle basse de calfeutrement (raccord de socle)
13.13	Attikaabschluss	parapet	couvre-mur
13.14	UBE für Naturstein Schnittübersicht	UBE for natural stone summery of sections	UBE pour pierre naturelle vue d'ensemble
13.15	Isometrie	isometric view	dessin isométrique
13.16	Schnitt horizontal	section horizontal	coupe horizontale
13.17	Schnitt vertikal	section vertical	coupe verticale
13.18	Profilübersicht UBE NG2 und UBE für Naturstein	profile list UBE NG2 and UBE for natural stone	ensemble de profil UBE NG2 et UBE pour pierre naturelle

UBE NG2

Schnittübersicht

summery of sections

vue d'ensemble

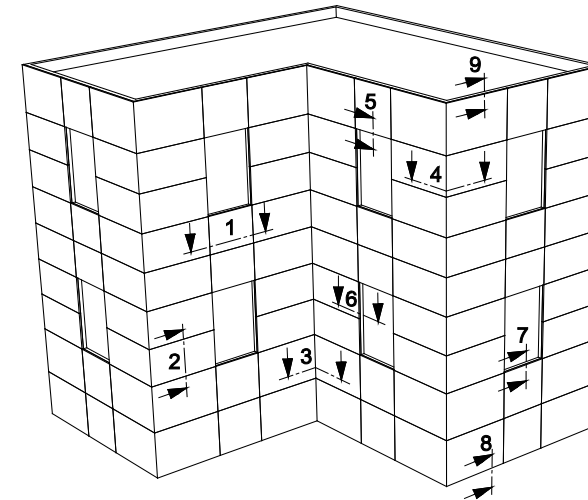

Schnitt 1: horizontal
Schnitt 2: vertikal
Schnitt 3: Innenecke
Schnitt 4: Außenecke
Schnitt 5: Fenstersturz
Schnitt 6: Fensterlaibung
Schnitt 7: Fensterbank
Schnitt 8: Sockelabschluss
Schnitt 9: Attikaabschluss

section 1: horizontal
section 2: vertical
section 3: internal corner
section 4: external corner
section 5: window lintel
section 6: window recess
section 7: windowsill
section 8: bottom closure
section 9: parapet

coupe 1: horizontale
coupe 2: verticale
coupe 3: coin intérieur
coupe 4: coin extérieur
coupe 5: linteau
coupe 6: joue de fenêtre
coupe 7: bavette de fenêtre extérieure
coupe 8: tôle basse de calfeutrement (raccord de socle)
coupe 9: couvre-mur

UBE NG2

Unterkonstruktionen für ebene Fassadenplatten

holding tracks for flat wall panels

ossature pour des plaques façade lisse

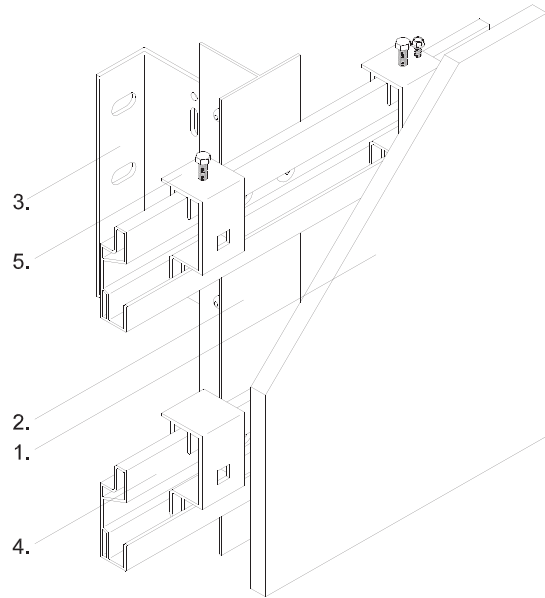

Agraffe/holding bracket/agrafe

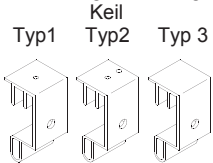

Agraffe/holding bracket/agrafe

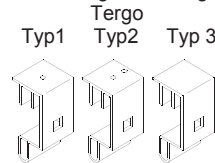

1. Fassadenbekleidung
2. senkrechtes Tragprofil
3. Systema L-Wandkonsole
4. Tragprofil UBE "NG2" Neu
5. Agraffe für UBE "NG2" Neu

1. cladding panel
2. vertical holding track
3. Systema L-bracket
4. holding track UBE "NG2" new
5. holding bracket for UBE "NG2" new

1. revêtement de façade
2. profil support vertical
3. équerre en L Systema
4. profil support UBE "NG2" nouveau
5. agrafe pour UBE "NG2" nouveau

Schnitt 1 horizontal

Bekleidung: Keramik, Faserzement, Naturstein, Feinsteinzeug, HPL mit Hinterschnittbefestigung

section 1 horizontal

cladding: ceramic panels, fiber cement, natural stone, porcelain stoneware, HPL fixing with non-expanding anchor bolts

coupe 1 horizontale

revêtement de façade: céramique, ciment fibre, pierre naturelle, grès cérame fin vitrifié, HPL à fixation antérieure

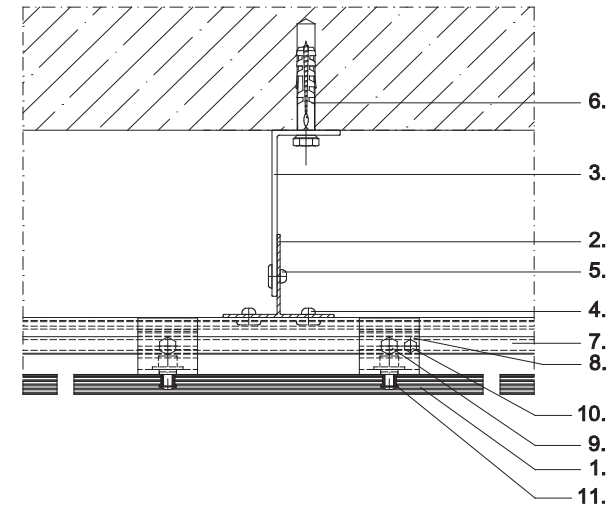

1. Fassadenbekleidung
2. senkrechtes Tragprofil
3. Systema L-Wandkonsole
4. Befestigungsriem
5. Verbindungsriem
6. Verankerung
7. Tragprofil UBE "NG2" Neu
8. Agraffe für UBE "NG2" Neu
9. Justierschraube
10. Feststellschraube
11. Hinterschnittdübel

1. cladding panel
2. vertical holding track
3. Systema L-bracket
4. fixing rivet
5. connecting rivet
6. fixing
7. holding track UBE "NG2" new
8. holding bracket for UBE "NG2" new
9. adjustment screw
10. locking screw
11. non-expanding anchor bolt

1. revêtement de façade
2. profil support vertical
3. équerre en L Systema
4. rivet de fixation
5. jonction
6. ancrage
7. profil support UBE "NG2" nouveau
8. agrafe pour UBE "NG2" nouveau
9. vis de réglage
10. vis de serrage
11. cheville antérieure

Schnitt 2 vertikal

Bekleidung: Keramik,
Faserzement, Naturstein,
Feinsteinzeug, HPL mit
Hinterschnittbefestigung

section 2 vertical

cladding: ceramic panels,
fiber cement, natural stone,
porcelain stoneware, HPL
fixing with non-expanding
achor bolts

coupe 2 verticale

revêtement de façade:
céramique, ciment fibre,
pierre naturelle, grès cérame
fin vitrifié, HPL à fixation
antérieure

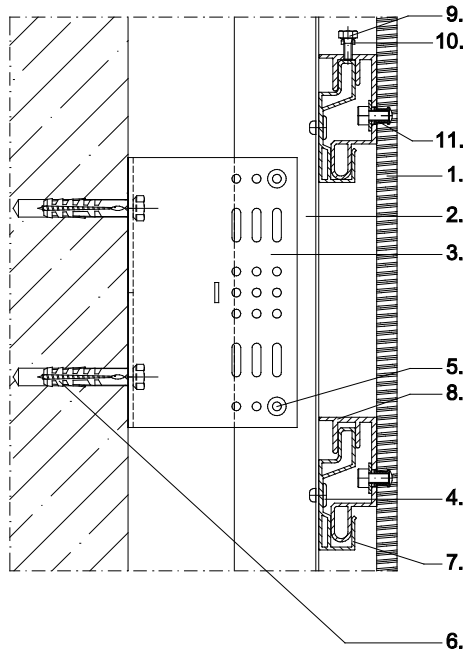

- | | | |
|------------------------------|--------------------------------------|-------------------------------------|
| 1. Fassadenbekleidung | 1. cladding panel | 1. revêtement de façade |
| 2. senkrechtes Tragprofil | 2. vertical holding track | 2. profil support vertical |
| 3. Systema L-Wandkonsole | 3. Systema L-bracket | 3. équerre en L Systema |
| 4. Befestigungsniet | 4. fixing rivet | 4. rivet de fixation |
| 5. Verbindungsniet | 5. connecting rivet | 5. jonction |
| 6. Verankerung | 6. fixing | 6. ancrage |
| 7. Tragprofil UBE "NG2" Neu | 7. holding track UBE "NG2" new | 7. profil support UBE "NG2" nouveau |
| 8. Agraffe für UBE "NG2" Neu | 8. holding bracket for UBE "NG2" new | 8. agrafe pour UBE "NG2" nouveau |
| 9. Justierschraube | 9. adjustment screw | 9. vis de réglage |
| 10. Feststellschraube | 10. locking screw | 10. vis de serrage |
| 11. Hinterschnittdübel | 11. non-expanding anchor bolt | 11. cheville antérieure |

Schnitt 3 Innenecke

Bekleidung: Keramik,
Faserzement, Naturstein,
Feinsteinzeug, HPL mit
Hinterschnittbefestigung

section 3 internal corner

cladding: ceramic panels,
fiber cement, natural stone,
porcelain stoneware, HPL
fixing with non-expanding
achor bolts

coupe 3 coin intérieur

revêtement de façade:
céramique, ciment fibre,
pierre naturelle, grès cérame
fin vitrifié, HPL à fixation
antérieure

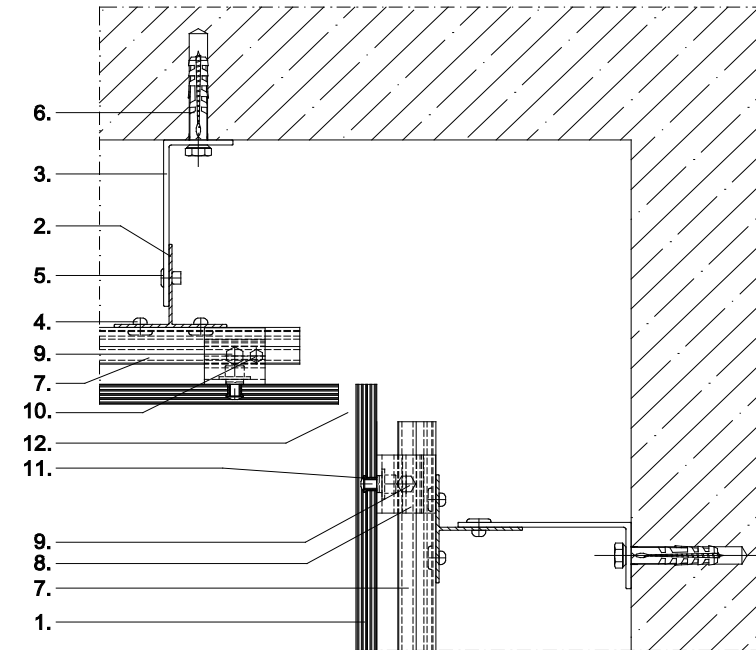

- | | | |
|-------------------------------|--------------------------------------|-------------------------------------|
| 1. Fassadenbekleidung | 1. cladding panel | 1. revêtement de façade |
| 2. senkrechtes Tragprofil | 2. vertical holding track | 2. profil support vertical |
| 3. Systema L-Wandkonsole | 3. Systema L-bracket | 3. équerre en L Systema |
| 4. Befestigungsniet | 4. fixing rivet | 4. rivet de fixation |
| 5. Verbindungsniet | 5. connecting rivet | 5. jonction |
| 6. Verankerung | 6. fixing | 6. ancrage |
| 7. Tragprofil UBE "NG2" Neu | 7. holding track UBE "NG2" new | 7. profil support UBE "NG2" nouveau |
| 8. Agraffe für UBE "NG2" Neu | 8. holding bracket for UBE "NG2" new | 8. agrafe pour UBE "NG2" nouveau |
| 9. Justierschraube | 9. adjustment screw | 9. vis de réglage |
| 10. Feststellschraube | 10. locking screw | 10. vis de serrage |
| 11. Hinterschnittdübel | 11. non-expanding anchor bolt | 11. cheville antérieure |
| 12. Innenecke stumpf gestoßen | 12. internal corner, blunt | 12. coin intérieure bout à bout |

Schnitt 4 Außenecke stumpf gestoßen

Bekleidung: Keramik,
Faserzement, Naturstein,
Feinsteinzeug, HPL mit
Hinterschnittbefestigung

section 4 external corner blunt

cladding: ceramic panels,
fiber cement, natural stone,
porcelaine stoneware, HPL
fixing with non-expanding
achor bolts

coupe 4 coin extérieur bout à bout

revêtement de façade:
céramique, ciment fibre, pierre
naturelle, grès cérame fin
vitrifié, HPL à fixation
antérieure

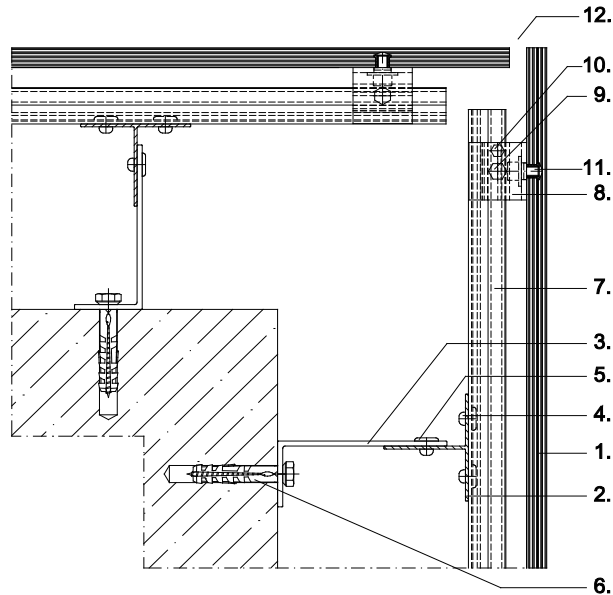

- | | | |
|-------------------------------|--------------------------------------|-------------------------------------|
| 1. Fassadenbekleidung | 1. cladding panel | 1. revêtement de façade |
| 2. senkrecht Tragprofil | 2. vertical holding track | 2. profil support vertical |
| 3. Systema L-Wandkonsole | 3. Systema L-bracket | 3. équerre en L Systema |
| 4. Befestigungsniel | 4. fixing rivet | 4. rivet de fixation |
| 5. Verbindungsniel | 5. connecting rivet | 5. jonction |
| 6. Verankerung | 6. fixing | 6. ancrage |
| 7. Tragprofil UBE "NG2" Neu | 7. holding track UBE "NG2" new | 7. profil support UBE "NG2" nouveau |
| 8. Agraffe für UBE "NG2" Neu | 8. holding bracket for UBE "NG2" new | 8. agrafe pour UBE "NG2" nouveau |
| 9. Justierschraube | 9. adjustment screw | 9. vis de réglage |
| 10. Feststellschraube | 10. locking screw | 10. vis de serrage |
| 11. Hinterschnittdübel | 11. non-expanding anchor bolt | 11. cheville antérieure |
| 12. Außenecke stumpf gestoßen | 12. outward corner, blunt | 12. coin extérieur bout à bout |

Schnitt 4 Außenecke mit negativem Winkel

Bekleidung: Keramik,
Faserzement, Naturstein,
Feinsteinzeug, HPL mit
Hinterschnittbefestigung

section 4 external corner with negative angle

cladding: ceramic panels,
fiber cement, natural stone,
porcelaine stoneware, HPL
fixing with non-expanding
achor bolts

coupe 4 coin extérieur à angle négatif

revêtement de façade:
céramique, ciment fibre, pierre
naturelle, grès cérame fin
vitrifié, HPL à fixation
antérieure

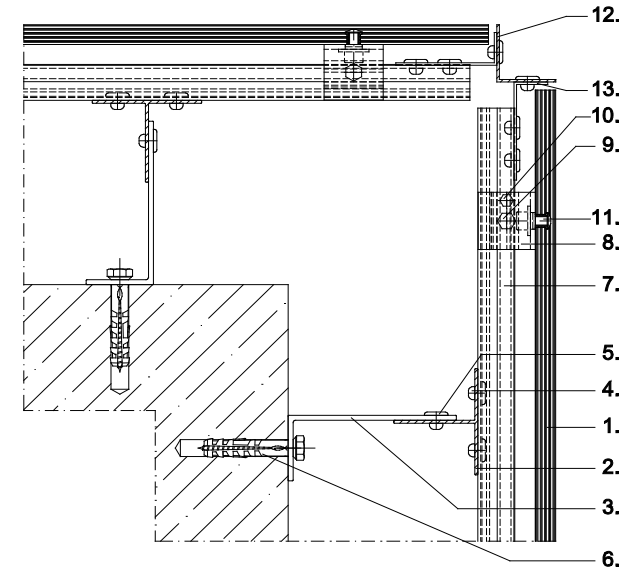

- | | | |
|-------------------------------------|--|---|
| 1. Fassadenbekleidung | 1. cladding panel | 1. revêtement de façade |
| 2. senkrecht Tragprofil | 2. vertical holding track | 2. profil support vertical |
| 3. Systema L-Wandkonsole | 3. Systema L-bracket | 3. équerre en L Systema |
| 4. Befestigungsniel | 4. fixing rivet | 4. rivet de fixation |
| 5. Verbindungsniel | 5. connecting rivet | 5. jonction |
| 6. Verankerung | 6. fixing | 6. ancrage |
| 7. Tragprofil UBE "NG2" Neu | 7. holding track UBE "NG2" new | 7. profil support UBE "NG2" nouveau |
| 8. Agraffe für UBE "NG2" Neu | 8. holding bracket for UBE "NG2" new | 8. agrafe pour UBE "NG2" nouveau |
| 9. Justierschraube | 9. adjustment screw | 9. vis de réglage |
| 10. Feststellschraube | 10. locking screw | 10. vis de serrage |
| 11. Hinterschnittdübel | 11. non-expanding anchor bolt | 11. cheville antérieure |
| 12. Außenecke mit Negativausbildung | 12. outward corner with negative angle | 12. profil extérieur à configuration négative |
| 13. Winkelprofil | 13. angle profile | 13. profil d'équerre |

Schnitt 5 Fenstersturz

Bekleidung: Keramik,
Faserzement, Naturstein,
Feinsteinzeug, HPL mit
Hinterschnittbefestigung

section 5 window lintel

cladding: ceramic panels,
fiber cement, natural stone,
porcelain stoneware, HPL
fixing with non-expanding
achor bolts

coupe 5 linteau

revêtement de façade:
céramique, ciment fibre, pierre
naturelle, grès cérame fin
vitrifié, HPL à fixation
antérieure

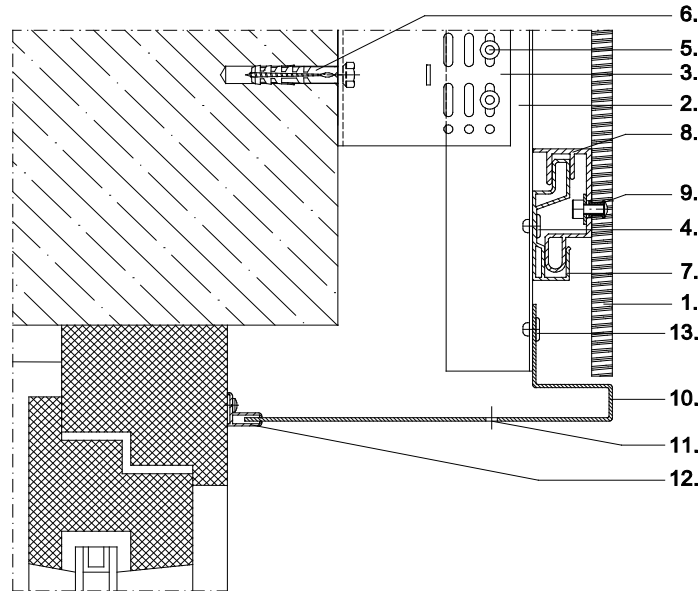

- | | | |
|------------------------------|--------------------------------------|-------------------------------------|
| 1. Fassadenbekleidung | 1. cladding panel | 1. revêtement de façade |
| 2. senkrechtes Tragprofil | 2. vertical holding track | 2. profil support vertical |
| 3. Systema L-Wandkonsole | 3. Systema L-bracket | 3. équerre en L Systema |
| 4. Befestigungsniel | 4. fixing rivet | 4. rivet de fixation |
| 5. Verbindungsniel | 5. connecting rivet | 5. jonction |
| 6. Verankerung | 6. fixing | 6. ancrage |
| 7. Tragprofil UBE "NG2" Neu | 7. holding track UBE "NG2" new | 7. profil support UBE "NG2" nouveau |
| 8. Agraffe für UBE "NG2" Neu | 8. holding bracket for UBE "NG2" new | 8. agrafe pour UBE "NG2" nouveau |
| 9. Hinterschnittdübel | 9. non-expanding anchor bolt | 9. cheville antérieure |
| 10. Fensterzarge | 10. window frame | 10. châssis |
| 11. Belüftungsöffnung | 11. ventilation opening | 11. ventilation |
| 12. Systema Stimmgabelprofil | 12. Systema F-profile | 12. profil F Systema (diapason) |
| 13. Befestigungselement | 13. fixing element | 13. élément de fixation |

Schnitt 6 Fensterlaibung

Bekleidung: Keramik,
Faserzement, Naturstein,
Feinsteinzeug, HPL mit
Hinterschnittbefestigung

section 6 window recess

cladding: ceramic panels,
fiber cement, natural stone,
porcelain stoneware, HPL
fixing with non-expanding
achor bolts

coupe 6 joue de fenêtre

revêtement de façade:
céramique, ciment fibre,
pierre naturelle, grès cérame
fin vitrifié, HPL à fixation
antérieure

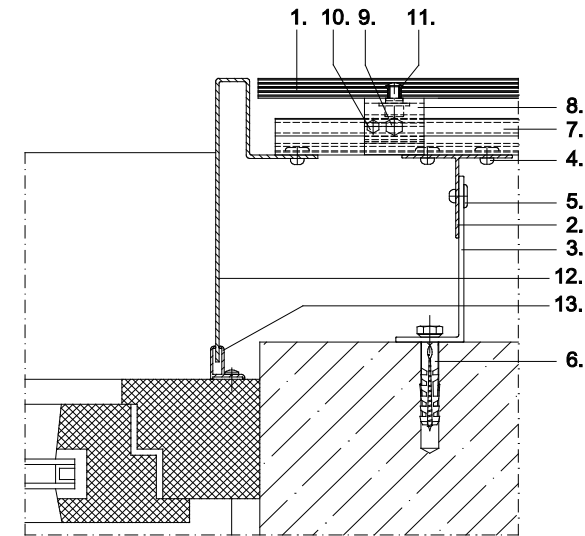

- | | | |
|------------------------------|--------------------------------------|-------------------------------------|
| 1. Fassadenbekleidung | 1. cladding panel | 1. revêtement de façade |
| 2. senkrechtes Tragprofil | 2. vertical holding track | 2. profil support vertical |
| 3. Systema L-Wandkonsole | 3. Systema L-bracket | 3. équerre en L Systema |
| 4. Befestigungsniel | 4. fixing rivet | 4. rivet de fixation |
| 5. Verbindungsniel | 5. connecting rivet | 5. jonction |
| 6. Verankerung | 6. fixing | 6. ancrage |
| 7. Tragprofil UBE "NG2" Neu | 7. holding track UBE "NG2" new | 7. profil support UBE "NG2" nouveau |
| 8. Agraffe für UBE "NG2" Neu | 8. holding bracket for UBE "NG2" new | 8. agrafe pour UBE "NG2" nouveau |
| 9. Justierschraube | 9. adjustment screw | 9. vis de réglage |
| 10. Feststellschraube | 10. locking screw | 10. vis de serrage |
| 11. Hinterschnittdübel | 11. non-expanding anchor bolt | 11. cheville antérieure |
| 12. Fensterzarge | 12. window frame | 12. châssis |
| 13. Systema Stimmgabelprofil | 13. Systema F-profile | 13. profil F Systema (diapason) |

Schnitt 7 Fensterbank

Bekleidung: Keramik,
Faserzement, Naturstein,
Feinsteinzeug, HPL mit
Hinterschnittbefestigung

section 7 windowsill

cladding: ceramic panels,
fiber cement, natural stone,
porcelaine stoneware, HPL
fixing with non-expanding
achor bolts

coupe 7 bavette de fenêtre extérieure

revêtement de façade:
céramique, ciment fibre,
pierre naturelle, grès cérame
fin vitrifié, HPL à fixation
antérieure

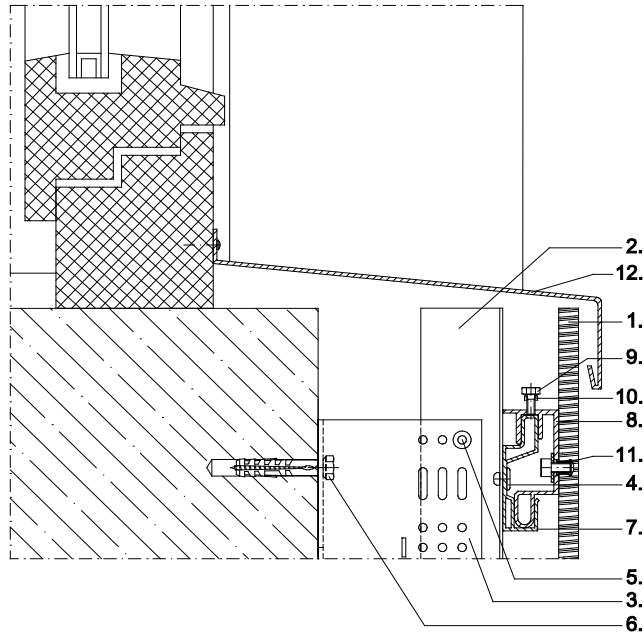

- | | | |
|------------------------------|--------------------------------------|-------------------------------------|
| 1. Fassadenbekleidung | 1. cladding panel | 1. revêtement de façade |
| 2. senkrechtes Tragprofil | 2. vertical holding track | 2. profil support vertical |
| 3. Systema L-Wandkonsole | 3. Systema L-bracket | 3. équerre en L Systema |
| 4. Befestigungsniel | 4. fixing rivet | 4. rivet de fixation |
| 5. Verbindungsniel | 5. connecting rivet | 5. jonction |
| 6. Verankerung | 6. fixing | 6. ancrage |
| 7. Tragprofil UBE "NG2" Neu | 7. holding track UBE "NG2" new | 7. profil support UBE "NG2" nouveau |
| 8. Agraffe für UBE "NG2" Neu | 8. holding bracket for UBE "NG2" new | 8. agrafe pour UBE "NG2" nouveau |
| 9. Justierschraube | 9. adjustment screw | 9. vis de réglage |
| 10. Feststellschraube | 10. locking screw | 10. vis de serrage |
| 11. Hinterschnittdübel | 11. non-expanding anchor bolt | 11. cheville antérieure |
| 12. Systema Fensterbank | 12. Systema windowsill | 12. bavette Systema |

Schnitt 8 Sockelabschluss

Bekleidung: Keramik,
Faserzement, Naturstein,
Feinsteinzeug, HPL mit
Hinterschnittbefestigung

section 8 bottom closure

cladding: ceramic panels,
fiber cement, natural stone,
porcelaine stoneware, HPL
fixing with non-expanding
achor bolts

coupe 8 tôle basse de cafeutrement (raccord de socle)

revêtement de façade:
céramique, ciment fibre,
pierre naturelle, grès cérame
fin vitrifié, HPL à fixation
antérieure

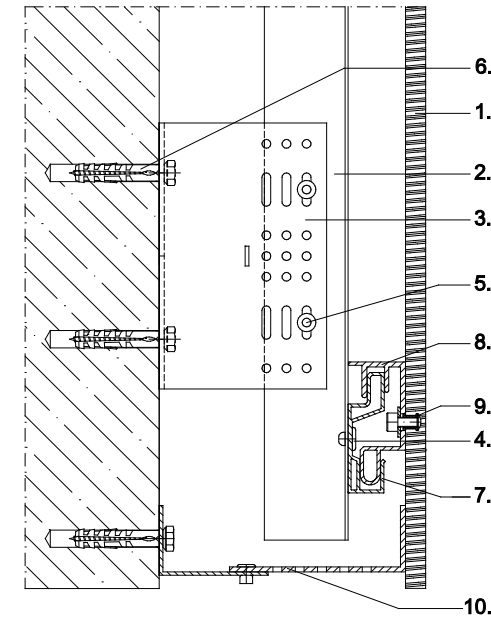

- | | | |
|-----------------------------------|--------------------------------------|-------------------------------------|
| 2. senkrechtes Tragprofil | 2. vertical holding track | 2. profil support vertical |
| 3. Systema L-Wandkonsole | 3. Systema L-bracket | 3. équerre en L Systema |
| 4. Befestigungsniel | 4. fixing rivet | 4. rivet de fixation |
| 5. Verbindungsniel | 5. connecting rivet | 5. jonction |
| 6. Verankerung | 6. fixing | 6. ancrage |
| 7. Tragprofil UBE "NG2" Neu | 7. holding track UBE "NG2" new | 7. profil support UBE "NG2" nouveau |
| 8. Agraffe für UBE "NG2" Neu | 8. holding bracket for UBE "NG2" new | 8. agrafe pour UBE "NG2" nouveau |
| 9. Hinterschnittdübel | 9. non-expanding anchor bolt | 9. cheville antérieure |
| 10. Abschlusswinkel mit Belüftung | 10. ventilated angle | 10. angle pour ventilation |

Schnitt 9 Attikaabschluss

Bekleidung: Keramik,
Faserzement, Naturstein,
Feinsteinzeug, HPL mit
Hinterschnittbefestigung

section 9 parapet

cladding: ceramic panels,
fiber cement, natural stone,
porcelain stoneware, HPL
fixing with non-expanding
achor bolts

coupe 9 couvre-mur

revêtement de façade:
céramique, ciment fibre,
pierre naturelle, grès cérame
fin vitrifié, HPL à fixation
antérieure

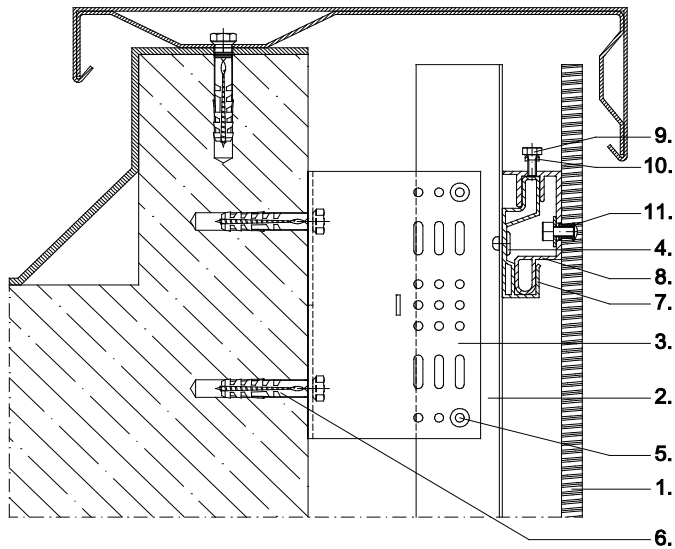

- | | | |
|------------------------------|--------------------------------------|-------------------------------------|
| 1. Fassadenbekleidung | 1. cladding panel | 1. revêtement de façade |
| 2. senkrechtes Tragprofil | 2. vertical holding track | 2. profil support vertical |
| 3. Systema L-Wandkonsole | 3. Systema L-bracket | 3. équerre en L Systema |
| 4. Befestigungsniet | 4. fixing rivet | 4. rivet de fixation |
| 5. Verbindungsniet | 5. connecting rivet | 5. jonction |
| 6. Verankerung | 6. fixing | 6. ancrage |
| 7. Tragprofil UBE "NG2" Neu | 7. holding track UBE "NG2" new | 7. profil support UBE "NG2" nouveau |
| 8. Agraffe für UBE "NG2" Neu | 8. holding bracket for UBE "NG2" new | 8. agraffe pour UBE "NG2" nouveau |
| 9. Justierschraube | 9. adjustment screw | 9. vis de réglage |
| 10. Feststellschraube | 10. locking screw | 10. vis de serrage |
| 11. Hinterschnittdübel | 11. non-expanding anchor bolt | 11. cheville antérieure |

UBE Naturstein

Schnittübersicht

summary of sections

vue d'ensemble

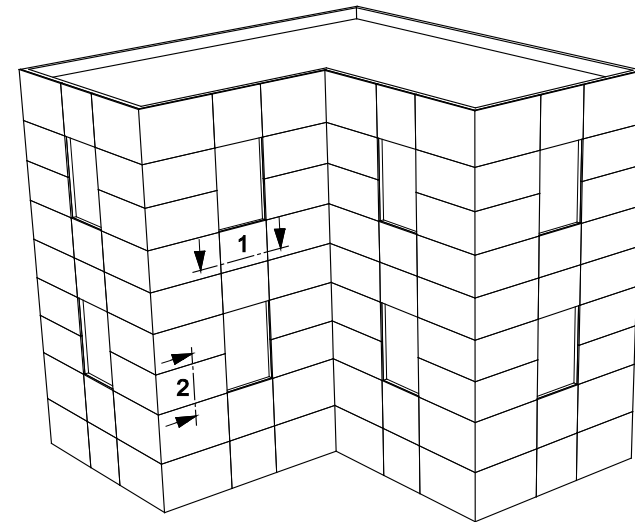

Schnitt 1: horizontal
Schnitt 2: vertikal

section 1: horizontal
section 2: vertical

coupe 1: horizontale
coupe 2: verticale

UBE Naturstein

Unterkonstruktionen für
Naturstein

holding tracks for
natural stone

ossature pour
pierre naturelle

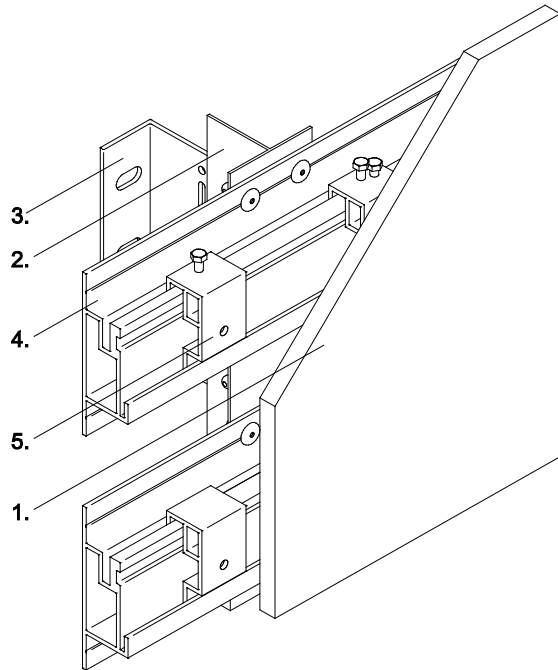

- 1. Fassadenbekleidung
- 2. senkrechtes Tragprofil
- 3. Systema L-Wandkonsole
- 4. Tragprofil für Naturstein
- 5. Agraffe für Naturstein

- 1. cladding panel
- 2. vertical holding track
- 3. Systema L-bracket
- 4. holding track for natural stone
- 5. holding bracket for natural stone

- 1. revêtement de façade
- 2. profil support vertical
- 3. équerre en L Systema
- 4. profil support pour pierre naturelle
- 5. agrafe pour pierre naturelle

Schnitt 1 horizontal

section 1 horizontal

coupe 1 horizontale

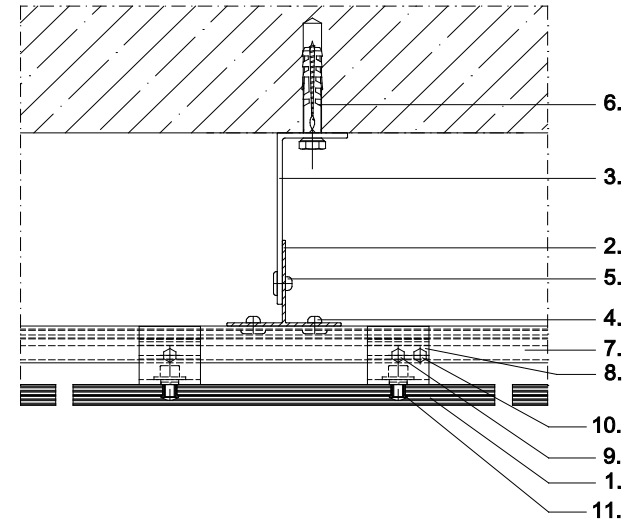

- 1. Fassadenbekleidung
- 2. senkrechtes Tragprofil
- 3. Systema L-Wandkonsole
- 4. Befestigungsriev
- 5. Verbindungsriev
- 6. Verankerung
- 7. Tragprofil für Naturstein
- 8. Agraffe für Naturstein
- 9. Justierschraube
- 10. Feststellschraube
- 11. Hinterschnittdübel

- 1. cladding panel
- 2. vertical holding track
- 3. Systema L-bracket
- 4. fixing rivet
- 5. connecting rivet
- 6. fixing
- 7. holding track for natural stone
- 8. holding bracket for natural stone
- 9. adjustment screw
- 10. locking screw
- 11. non-expanding anchor bolt

- 1. revêtement de façade
- 2. profil support vertical
- 3. équerre en L Systema
- 4. rivet de fixation
- 5. jonction
- 6. ancrage
- 7. profil support pour pierre naturelle
- 8. agrafe pour pierre naturelle
- 9. vis de réglage
- 10. vis de serrage
- 11. cheville antérieure

Schnitt 2
vertikal

section 2
vertical

coupe 2
verticale

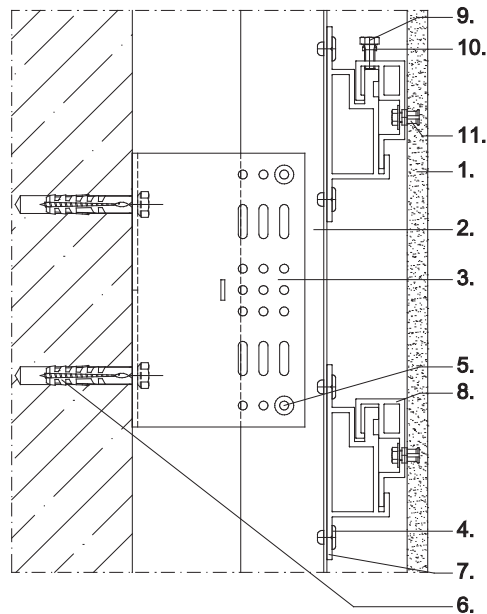



- | | | |
|------------------------------|--------------------------------------|---|
| 1. Fassadenbekleidung | 1. cladding panel | 1. revêtement de façade |
| 2. senkrechtes Tragprofil | 2. vertical holding track | 2. profil support vertical |
| 3. Systema L-Wandkonsole | 3. Systema L-bracket | 3. équerre en L Systema |
| 4. Befestigungsniel | 4. fixing rivet | 4. rivet de fixation |
| 5. Verbindungsniel | 5. connecting rivet | 5. jonction |
| 6. Verankerung | 6. fixing | 6. ancrage |
| 7. Tragprofil für Naturstein | 7. holding track for natural stone | 7. profil support pour pierre naturelle |
| 8. Agraffe für Naturstein | 8. holding bracket for natural stone | 8. agrafe pour pierre naturelle |
| 9. Justierschraube | 9. adjustment screw | 9. vis de réglage |
| 10. Feststellschraube | | |
| 11. Hinterschnittdübel | | |

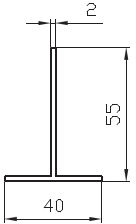
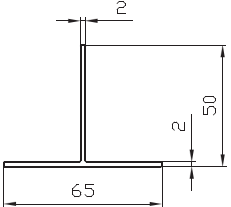

Inhaltsverzeichnis Profilübersicht UBE NG2 und UBE für Naturstein
Contents profile list UBE NG2 et UBE for natural stone
Index ensemble de profil UBE NG2 et UBE pour pierre naturelle

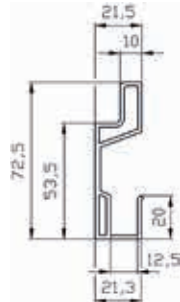
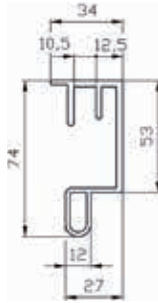
Seite page page	Profile	profiles	profilés
	vertikale Tragprofile	vertical holding tracks	rails porteurs verticaux
14.19	T-Profil 40/55 T-Profil 65/50 Wanddicke 2mm	T-profile 40/55 T-profile 65/50 wall thickness 2mm	profil T 40/55 profil T 65/50 épaisseur du mur 2mm
	Systemprofile UBE	system profiles UBE	profilés de système UBE
14.20	Tragprofil UBE "NG2" NEU Agraffe für UBE "NG2" NEU	holding track UBE "NG2" new holding bracket for UBE "NG2" new	profil support UBE "NG2" nouveau agrafe pour UBE "NG2" nouveau
14.21	Tragprofil für Naturstein Agraffe für Naturstein	holding track for natural stone holding bracket for natural stone	profil support pour pierre naturelle agrafe pour pierre naturelle
	L-Wandkonsolen	L-brackets	équerres en L
14.22	WB 0 - 85/160/250mm	WB 0 - 85/160/250mm	WB 0 - 85/160/250mm
14.23	WB 1-6 - 85/160/250mm	WB 1-6 - 85/160/250mm	WB 1-6 - 85/160/250mm
14.24	WB 7-9,5 - 85/160/250	WB 7-9,5 - 85/160/250	WB 7-9,5 - 85/160/250
14.25	WB 10-14 - 85/160/250mm	WB 10-14 - 85/160/250mm	WB 10-14 - 85/160/250mm

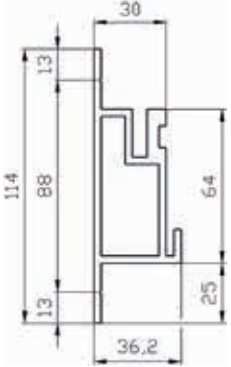
Profiltyp profile type type de profil	Länge (mm) length (mm) longueur (mm)	Material material matériel	Einzelpreis unit price prix unitaire
 <p>T-Profil 40/55 T-profile 40/55 profil T 40/55</p>	5600 6000	EN AW 6063 T66	
 <p>T-Profil 65/50 Wanddicke 2mm T-profile 65/50 wall thickness 2mm profil T 65/50 épaisseur du mur 2mm</p>	5600 6000	EN AW 6063 T66	

Profiltyp profile type type de profil	Länge (mm) length (mm) longueur (mm)	Material material matériel	Einzelpreis unit price prix unitaire
 <p>Tragprofil UBE „NG2“ Neu holding track UBE „NG2“ new profil support UBE „NG2“ nouveau</p>	6000	EN AW 6063 T66	
 <p>Agraffe für UBE „NG2“ NEU holding bracket for UBE „NG2“ new agrafe pour UBE „NG2“ nouveau</p>	Typ 1 Typ 2 Typ 3	EN AW 6063 T66	

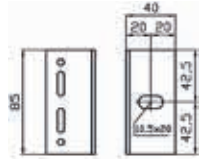
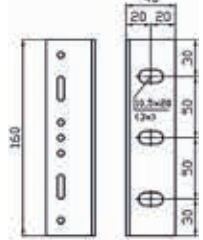
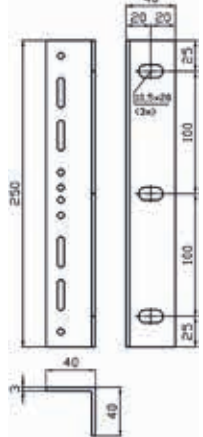
Profiltyp profile type type de profil	Länge (mm) length (mm) longueur (mm)	Material material matériel	Einzelpreis unit price prix unitaire
 <p>Tragprofil für Naturstein holding track for natural stone profil support pour pierre naturelle</p>	6000	EN AW 6063 T66	
 <p>Agraffe für Naturstein holding bracket for natural stone agrafe pour pierre naturelle</p>	Typ 1 Typ 2 Typ 3	EN AW 6063 T66	

Profiltyp profile type type de profil	Länge (mm) length (mm) longueur (mm)	Material material matériel	Einzelpreis unit price prix unitaire
	WB0 40/40/3-85	EN AW 6063 T66	
	WB0 40/40/3-160	EN AW 6063 T66	
	WB0 40/40/3-250	EN AW 6063 T66	
 <p>WB0 40/40/3 - 85/160/250mm</p>			

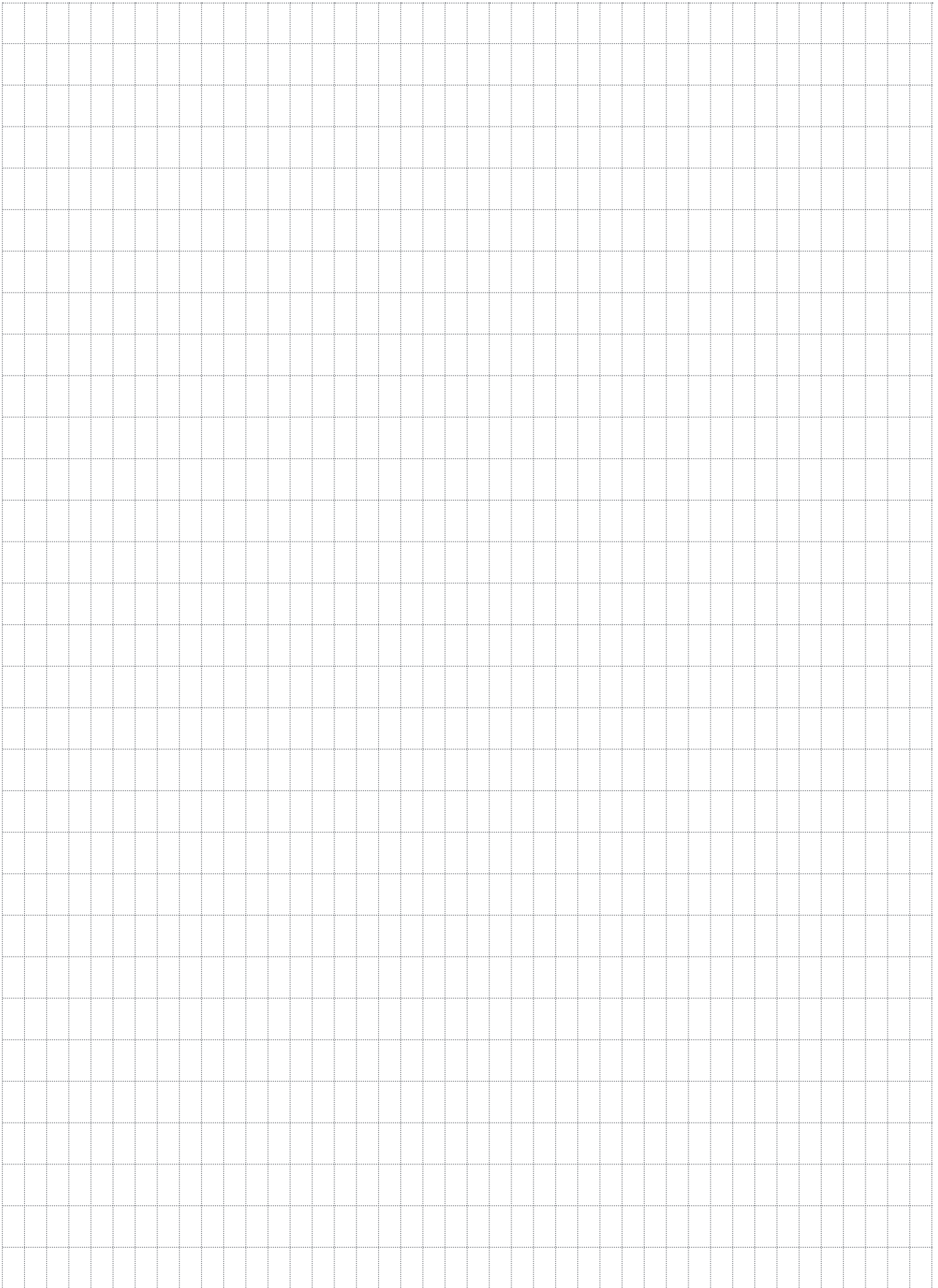

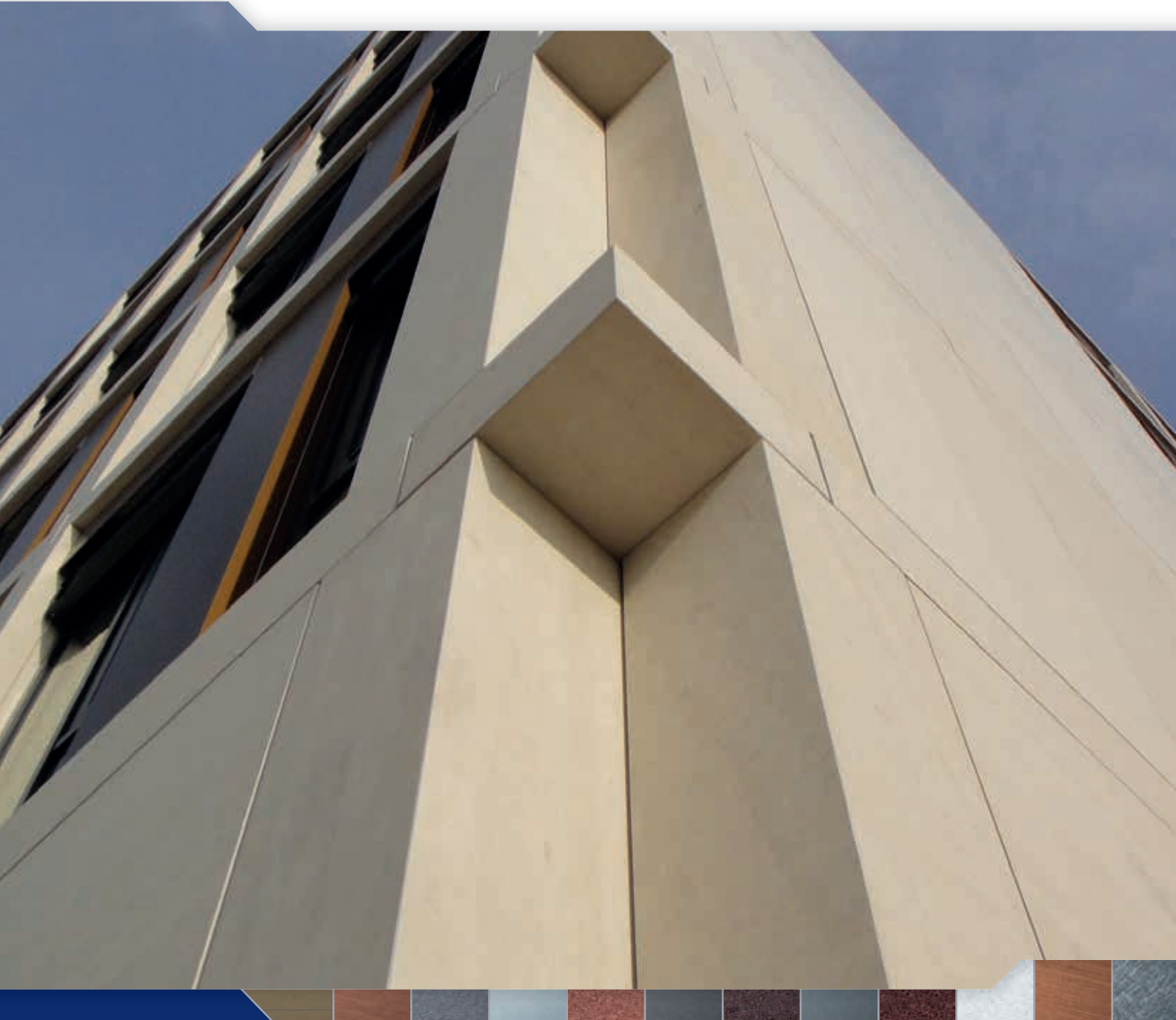

Systema[®]

Systema Pohl GmbH

Margarete-Steiff-Str. 6
D-24558 Henstedt-Ulzburg
Deutschland / Germany

Fon: +49 (0) 41 93 / 99 11-0
Fax: +49 (0) 41 93 / 99 11-49

info@systema.systems
www.systema.systems

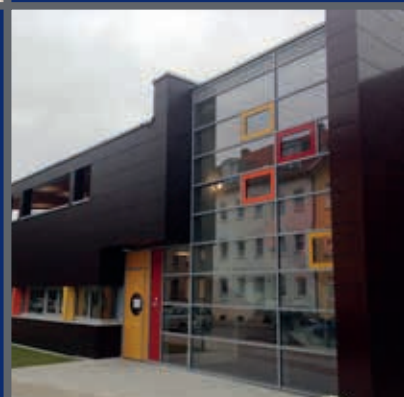
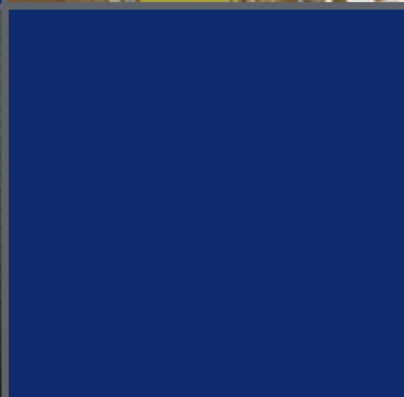
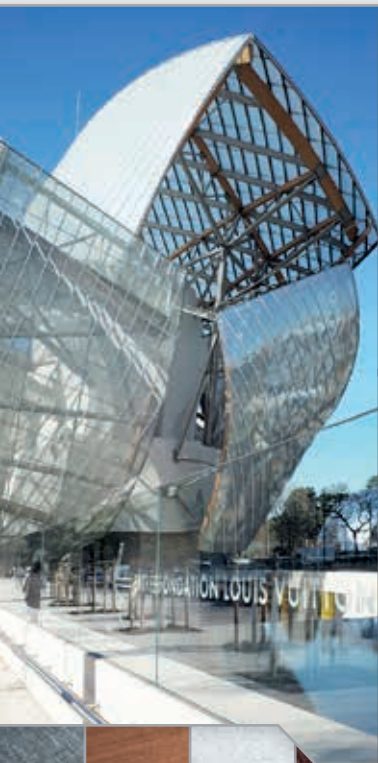

Bitte besuchen Sie uns für weitere
technische Informationen und
eine Vielzahl von Referenzen
im Internet: www.systema.systems

Ein Unternehmen der
POHL-Gruppe