



**INSULATED CONDUCTOR SYSTEM
U10**



INSULATED CONDUCTOR SYSTEM U10

CONTENT

General information	2	Compact current collector set KDS2/40	10
Technical data	4	Compact current collector set KUFR2/40	11
Joint (Feed)	5	Entry funnel	12
Line feed	5	Compact current collector KUFU25	13
Isolating assembly	5	Carbon brushes	14
Spacer clip	5	Springs	14
Expansion section	6	Connecting cables	15
Transfer guides	6	Terminal boxes	16
Anchor bracket (aluminum) for transfer guide	7	Brush wear indicator	16
Standard compact hangers	8	Installation tools	17
Locating clamps	8	Application questionnaire	19
Compact hangers (customer specific)	9		

GENERAL INFORMATION

The U10 insulated conductor system has been designed in accordance with VDE 0100. It complies with current conductor system safety requirements and protects against accidental human contact as stipulated by VDE 0470, part 1 (DIN EN 60526), (protection classification IP 21).

Fig. 1 illustrates that the VDE test “finger” cannot make contact with current carrying components. Compact collectors provide accidental contact protection only when the contact brushes are correctly and fully inside the conductors and covered by the insulating profile. Conductor systems located within reach of personnel, and with collectors exiting the conductors during operation, must have barriers or shut-off switches installed to prevent accidental contact. This is required only for conductor systems with operating voltage above 25 VAC or 60 VDC.



Fig 1: VDE test finger

U10 Conductor System is approved for indoor systems only.

Conductor systems may consist of any number of conductors. Space requirements are minimal. Contact opening at either downward or side-ways orientation is possible.

Standard length for conductor sections is 6 m, shorter sections are available.

The standard PE conductor is marked with a continuous yellow stripe at the insulating profile. The PE-VP ground conductor has a specifically shaped profile which reliably prevents the PE-VP collector from entering a phase conductor; thus, the support structure cannot be inadvertently electrified.

APPROVALS

UL Certification. Please consult us when ordering.

COMPACT HANGER

Compact hangers are used for conductor installation and will also provide and maintain the defined 14 mm phase distance. Hanger center distance is max. 0.6 m at straight sections, 0.3 m at curved sections.

JOINT SPLICE/FEED

Joint splice/feeds are used to mechanically and electrically connect U10 conductor sections. The included joint splice cap protects personnel from accidentally making contact when the system is under current. Each joint splice/feed can compensate for section expansion/contraction up to 4 mm.

FEED TERMINALS

A feed connection is possible at every joint splice. Also, each isolating assembly and transfer guide can serve as a feed location when a feed clip is installed. When additional feed points within a conductor section are required, feed terminals (inline only) may be installed.

TRANSFER GUIDES

Transfer guides serve as protection of the conductor end as well as a mechanical system separation. They also facilitate reliable passage of collector brushes at movable track sections such as track switches and lift stations. Installed with an aluminum anchor bracket (BFU), transfer guides lock the conductor ends in place at the support track thus creating a system fixpoint.

ISOLATING ASSEMBLIES (AIR GAP)

Isolating assemblies interrupt the electrical current flow in a conductor. To utilize current collectors with the operational task to switch current on/off is only permitted when using low energy control current. For control function, feed sections, maintenance sections etc. we are supplying isolating assemblies with or without SE feed clip.

CURVES

U10 insulated conductors can be bend horizontally or vertically. A curve bending tool is available to produce curves at an installation site.

CURRENT COLLECTOR

Current collectors are manufactured using impact resistant synthetic material and stainless steel components. Copper graphite or carbon contact brushes are used.

The length of the current collector cable cannot exceed 3 m if the installed overload protection is not rated for the current capacity of the cable. See also DIN VDE 0100, part 430 and DIN EN 60204-32. Connecting cables as supplied are sufficiently dimensioned for the listed nominal current. For installation variation reduction factors, as with DIN VDE 0298-4, must be observed.

DIN EN 60204-1 and DIN-EN 60204-2 stipulate that the reliability of PE systems using conductor brushes must be ensured. Doubling the PE collector is a practical and simple solution to achieve compliance.

INDUSTRIAL DESIGNATIONS

DIN — German Institute for Standards

EN — European Standard

ISO — International Organization for Standardization

IEC — International Electrotechnical Commission

VDE — German Electrotechnical Association

IP — International Protection type and classification

UL — International Protection type and classification

SAFETY NOTE

A safety distance of min. (0.5 m) between Conductor / Current Collector arrangement and other moving or fixed equipment must be kept to prevent accidental injury of personnel!

INSULATION PROFILE VALUES (ELECTRICAL)

Type	Dielectric insulation DIN 53481	Specific resistance IEC 60093	Surface resistivity IEC 60093	Leakage path resistance IEC 60112
Standard profile, green	>25 kV/mm	>1 x 10 ¹⁶ Ohm x cm	2.1 x 10 ¹⁵ Ohm	CTI 400 – 1.1
High temp. profile, gray	>25 kV/mm	>1 x 10 ¹⁴ Ohm x cm	2.1 x 10 ¹⁵ Ohm	CTI 400 – 1.1

INSULATION PROFILE VALUES (MECHANICAL)

Type	Bending rigidity ISO 178	Tensile strength ISO 527	UV resistance	Max. relative humidity	Ambient temperature range ⁽¹⁾	Flammability
Standard profile, green	74 – 85 N/mm ²	44 – 55 N/mm ²	Xenon test >1500	<100%	–30 °C to +55 °C	Flame resistant, self extinguishing, UL 94 V0
High temp. profile, gray	90 – 100 N/mm ²	47 – 65 N/mm ²	Xenon test >1500	<100%	–30 °C to +85 °C	Flame resistant, self extinguishing, UL 94 V0

TECHNICAL DATA

CONDUCTOR SECTION

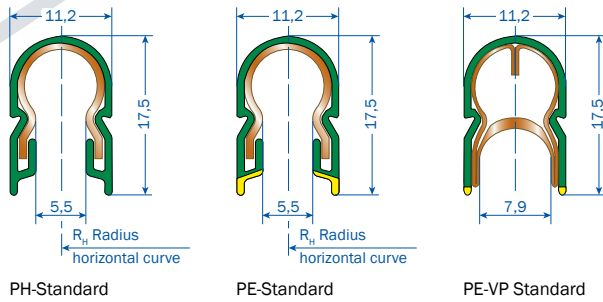

PH-Standard

PE-Standard

PE-VP Standard

CONDUCTOR CODE

U = Unipole insulated conductor
 10 = Profile dimensions
 25 = Conductor cross section (mm²)
 C = Copper conductor
 E = Stainless steel conductor

SUPPLIED LENGTH

6 m (19.6") standard section,
 shorter sections available

MAX. SUPPORT DISTANCE

Straight sections: 0.6 m (2")
 Curves: 0.3 m (1")

PHASE DISTANCE

Standard = 14 mm

BENDING CONDUCTORS

Without pre-bending $\infty \geq R \geq 5000$ mm

At site:

Horizontal curves $5000 \text{ mm} \geq R \geq 750$ mm

Inward/outward facing curves $5000 \text{ mm} \geq R \geq 750$ mm

Curves $R \leq 750$ mm pls. inquire.

APPLICATION

Indoor systems only

VERSIONS

Version	Type	Color	Weight kg/m	Order No.
Phase (standard profile)	U10/25C-....PH-B	green	0.267	167 00 •
	U10/25E-....PH-B	green	0.246	167 02 •
PE (standard profile)	U10/25C-....PE-A	green	0.267	167 06 •
	U10/25E-....PE-A	green	0.246	167 08 •
PE-VP (standard profile)	U10/25C-....VP-A	green	0.267	143 19 •
	U10/25C-....VPG-A ⁽⁴⁾	green	0.267	143 31 •
Phase (high temp. profile)	U10/25C-....PH-D85	grey	0.267	167 03 •
	U10/25E-....PH-D85	grey	0.246	167 05 •
PE (high temp. profile)	U10/25C-....PH-C85	grey	0.267	167 09 •
	U10/25E-....PE-C85	grey	0.246	167 11 •
PE-VP (high temp. profile)	U10/25C-....VP-C85	grey	0.267	143 20 •
	U10/25C-....VPG-C85 ⁽⁴⁾	grey	0.246	143 32 •

CONDUCTOR SYSTEM VALUES

Type	Leakage distance profile mm	Max. nominal Voltage ⁽³⁾	Max. continuous current A	Resistance Ohm/1000 m	Impedance ⁽²⁾ Ohm/1000 m
U10/25 C	30	690	100	0.744	0.748
U10/25 E	30	690	10	31.328	31.328

SELECTION OF CONDUCTORS

Conductor selection must consider required current capacity and existing environmental conditions.

- U10/25 C conductor system with copper conductor for main current, control signal and data
- U10/25 E conductor system with stainless steel conductor for control signal and data transmission at corrosive environments

(1) Type designation to be completed, e.g. U10/25E-6000PH-B for 6 m phase, order number 167026
 The four-digit number (printed bold) at the type designation indicates the length of the conductor section.

(2) Based on 14 mm phase distance at 50 Hz

(3) Not with UL certification $U_{UL} = 600$ V

(4) Only for curves facing inward

• The last numeral of the order number indicates the length of the conductor section in meters. Accordingly complete the order number with 1, 2, 3, 4, 5 or 6.

JOINT (FEED)

Max. 2x 40A continuous current

Compensates for up to 4 mm section expansion/contraction caused by temperature fluctuations

Connecting cables not included, please order from page 15

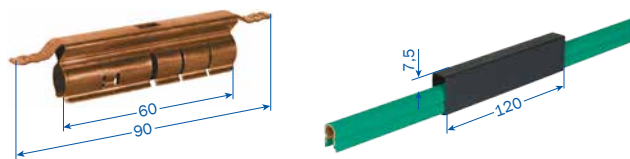

Type	Weight kg	Order No.
VM-UEV10/C	0.026	165006
VM-UEV10VP/C	0.026	143213

LINE FEED

Max. 2x 50A continuous current

Connecting cable not included, please order from page 15

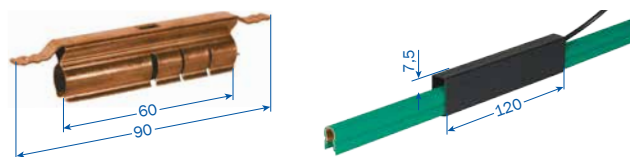

Type	Weight kg/m	Order No.
ES-UES10	0.026	165212
ES-UES10VP	0.026	143214

ISOLATING ASSEMBLY (AIR GAP)

Max. 40A continuous current

Two halves are joined during installation

Feed clip SE 10 with tab connector 6.3x0.8 mm (max. continuous current 40A), at least one additional compact hanger required for each isolating assembly.

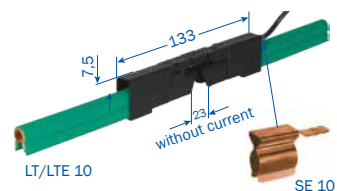

Type	Description	Weight kg	Comprising	Order No.
ST-LT/LT10		0.017	2x LT/U 10	165025
ST-LT/LTE10		0.021	2x LT/U 10 1x Feed clip SE 10	165114
ST-LTE/LTE10		0.025	2x LT/U 10 2x Feed clip SE 10	165026

SPACER CLIP

to provide support for isolating assembly by filling gap between isolating assembly and web of aluminum monorail track at 16.5 mm system height⁽¹⁾.



Type	Weight kg	Order No.
EU-DK10/16.5	0.002	165682

(1) System height = distance contact surface to back of compact hanger (at web of monorail track)

EXPANSION SECTION

single conductor, to be completed at installation site

Expansion capability of expansion section must equal the max. expansion capability of the EMS track.

Two fix points are required with each expansion section. Please order as required by the EMS track layout.

An additional compact hanger is required for each 15 mm expansion capability. Please add to your order as required.

Prefinished, complete expansion sections are also available as a 800 mm long section.

STANDARD

Type	Weight kg	Expansion	Order No.
VM-UDV10/C-30	0.052	up to 30 mm	166542
VM-UDV10/C-45	0.075	up to 45 mm	166543
VM-UDV10/C-60	0.104	up to 60 mm	166544

PE-VP

Type	Weight kg	Expansion	Order No.
VM-UDV10VP/C-30	0.052	up to 30 mm	143356
VM-UDV10VP/C-45	0.078	up to 45 mm	143357
VM-UDV10VP/C-60	0.104	up to 60 mm	143358

TRANSFER GUIDES

Max. vertical and horizontal offset ± 3 mm respective

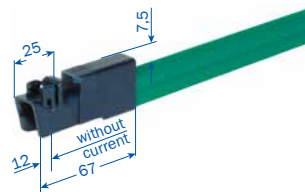
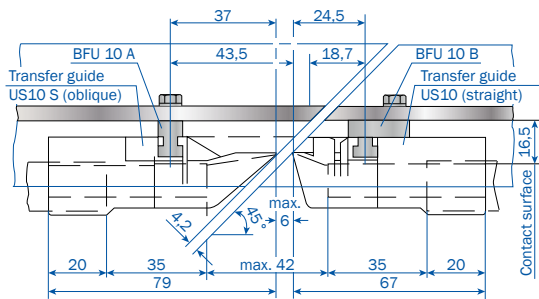

without feed clip: US 10

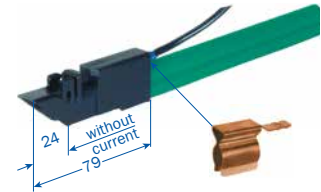

with feed clip: USE 10 S
(tab connector 6.3x0.8 mm)

TRANSFER GUIDE

Max. 40A continuous current

Type	Weight kg/m	Version	Feed clip	Order No.
MU-US10	0.008	straight	without	165008
MU-US10S	0.008	oblique	without	165009
MU-USE10	0.012	straight	with	165010
MU-USE10S	0.012	oblique	with	165011

TRANSFER GUIDE FOR PE-VP

Max. 40A continuous current



without feed clip:
US 10 PE-VP



without feed clip:
US 10 SP



with Feed clip:
USE 10 S-VP
(tab connector 6.3x0.8 mm)

Type	Weight kg/m	Version	Feed clip	Order No. Phase + PE
MU-US10-VP	0.007	straight	without	143208
MU-US10S-VP	0.007	oblique	without	143210
MU-US10SP-VP	0.008	oblique positive	without	143212
MU-USE10-VP	0.011	straight	with	143207
MU-USE10S-VP	0.011	oblique	with	143209
MU-USE10SP-VP	0.012	oblique positive	with	143211

ANCHOR BRACKET (ALUMINUM) FOR TRANSFER GUIDES

to be bolted to the track

Two holes to be drilled through the EMS track to screw on the anchor bracket from the back.

Kit comprises: 1 x anchor bracket, 2 x hex screws M5 with lock washer, 2 x roll pins 2x20.

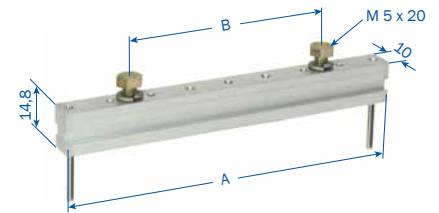

BFU 10A

for system height⁽¹⁾ = 16.5 mm

Type	No. of poles	A mm	B mm	Weight kg	Order No.
MU-BFU10H4/16.5/14-59/42	1 - 4	59	42	0.032	144422
MU-BFU10H6/16.5/14-90/42	1 - 6	90	42	0.040	144499
MU-BFU10H8/16.5/14-118/70	1 - 8	118	70	0.048	165168
MU-BFU10H10/16.5/14-143/70	1 - 10	143	70	0.056	165176

BFU 10B

to be used when EMS track has been cut obliquely (see drawing page 6).

for system height⁽¹⁾ = 16.5 mm

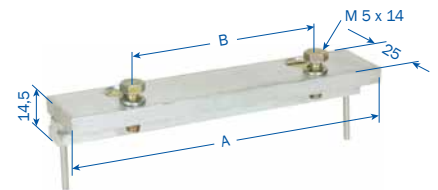

Type	No. of poles	A mm	B mm	Weight kg	Order No.
MU-BFU10H4/16.5/14-59/42-25	1 - 4	59	42	0.053	144419
MU-BFU10H6/16.5/14-90/42-25	1 - 6	90	42	0.065	143982
MU-BFU10H8/16.5/14-118/70-25	1 - 8	118	70	0.077	165272
MU-BFU10H10/16.5/14-143/70-25	1 - 10	143	70	0.089	165274

BFU 10

for system height⁽¹⁾ = 10.5 mm

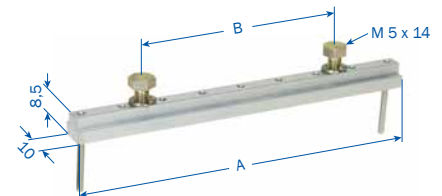

Type	No. of poles	A mm	B mm	Weight kg	Order No.
MU-BFU10H4/10/14-62/42	1 - 4	62	42	0.022	144022
MU-BFU10H6/10/14-90/42	1 - 6	90	42	0.026	143983
MU-BFU10H8/10/14-118/70	1 - 8	118	70	0.030	165115

BFU 10V

for system height⁽¹⁾ = 10.5 mm

Socketed head screws inserted at front of EMS track. Anchor bracket kit consists of:

1 x anchor bracket, 2 x socket head screws M5, 2 x roll pins.

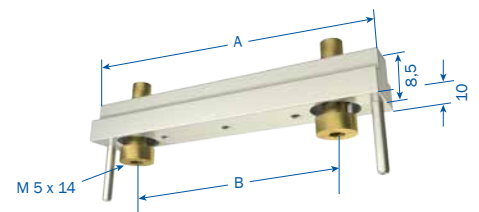

Type	No. of poles	A mm	B mm	Weight kg	Order No.
MU-BFU10V4/10/14-59/42	1 - 4	59	42	0.015	144355
MU-BFU10V6/10/14-90/42	1 - 6	90	42	0.021	144513
MU-BFU10V8/10/14-118/70	1 - 8	118	70	0.026	144514

(1) System height = distance contact surface to back of compact hanger (at web of monorail)

STANDARD COMPACT HANGERS

up to 10 conductors

These compact hangers may be combined to support any number of conductors.

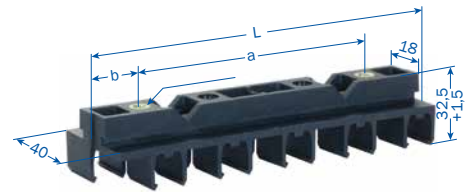

Type	Max. number of poles	L	a	b	Weight kg	Order No.
AH-KA10L-2/16.5-N-PA-14	2	29	0	20.5	0.012	142072
AH-KA10L-4/16.5-10N-PA-14	4	57	42	7.5	0.024	142073
AH-KA10L-6/16.5-10N-PA-14	6	85	42	21.5	0.033	142757
AH-KA10L-8/16.5-10N-PA-14	8	113	42	35.5	0.045	142075
AH-KA10L-10/16.5-N-PA-14	10	141	100	20.5	0.056	142076

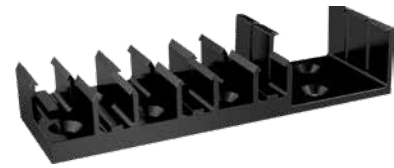

COMPACT HANGER KA10 (USED WITH SCREWS)

6 conductor + SMGM

Type	Max. number of poles	L	Weight kg	Order No.
AH-KA10-4/10.5-UNI-PA-SMG-14	4	100	0.027	144354
AH-KA10-6/10.5-UNI-PA-SMG-14	6	128	0.036	100102 11

LOCATING CLAMPS

2 ea. USK location clamps are required for each fix point



Illustration shows positioning of the two Locating clamps at a compact hanger

LOCATING CLAMP STANDARD

Type	Weight kg	Order No.
USK10	0.006	165645



Illustration shows positioning of the two locating clamps at a compact hanger

LOCATING CLAMP PE-VP

Type	Weight kg	Order No.
USK10A-VP	0.001	2823268

COMPACT HANGERS (CUSTOMER SPECIFIC)

Engineered and manufactured to fit customer specific EMS track

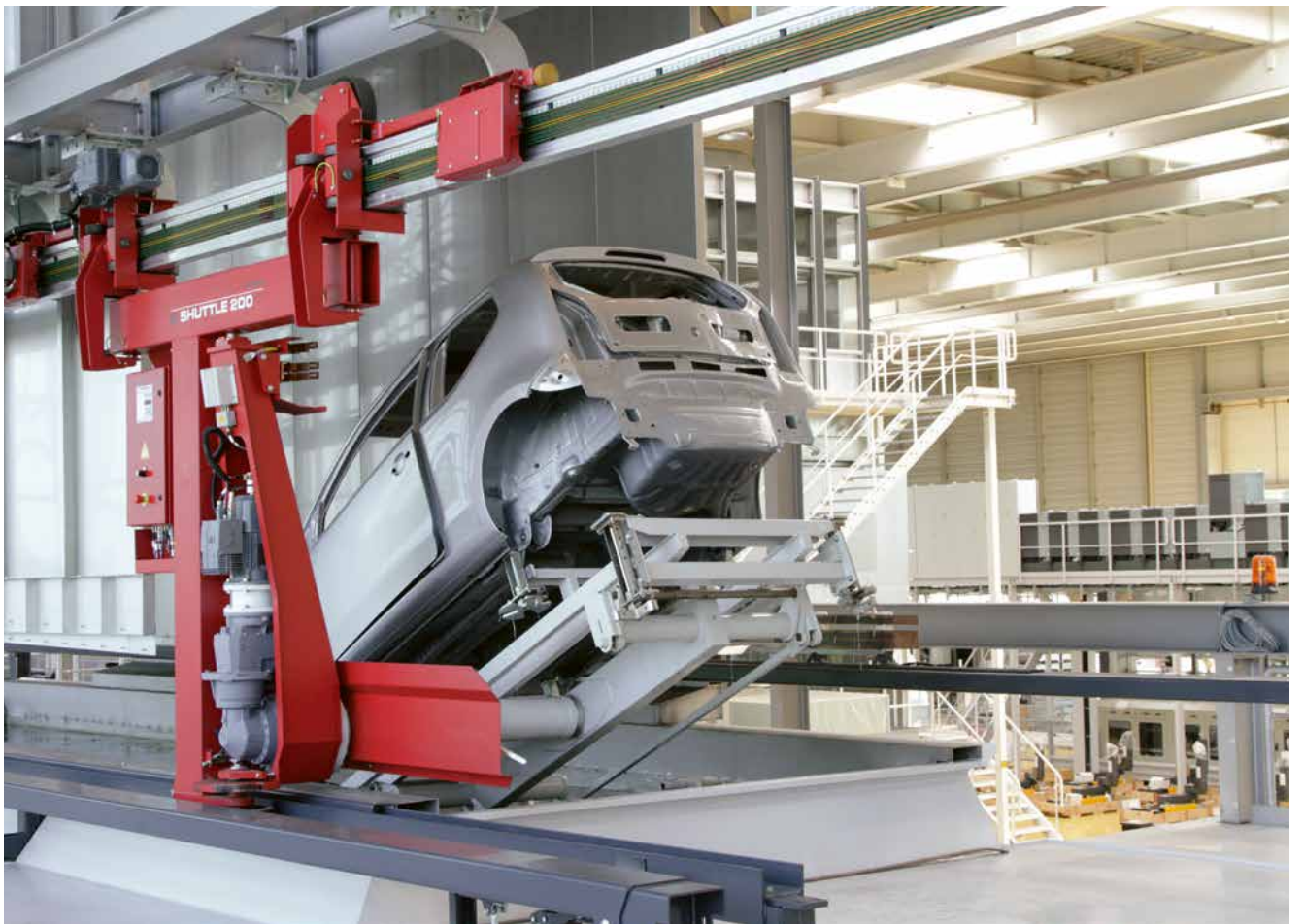
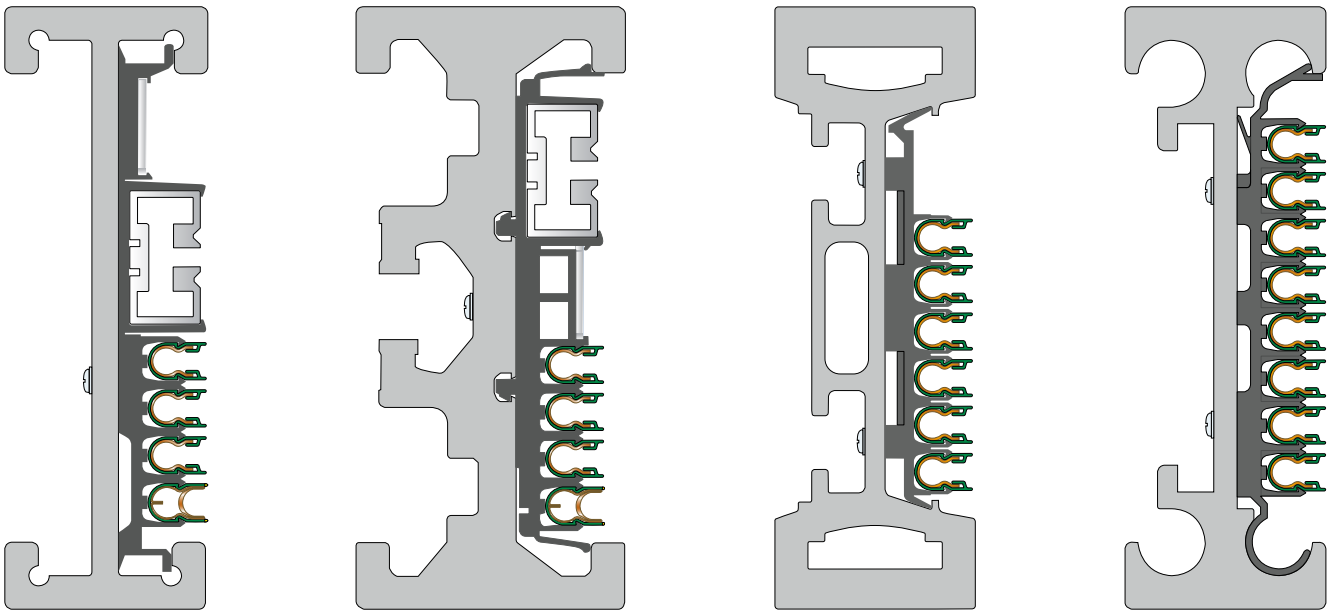

KUFR2/40

for installations requiring bi-directional travel
with 1x0.5 m connecting cable type WFLA 2.5

Max. current:	1 connecting cable 2.5 mm ² , 25 A 2 connecting cables 2.5 mm ² , 40 A
Stroke:	±15 mm
Swivel:	±15 mm
Contact pressure:	approx. 3.5 N per contact brush
Connecting cable:	2.5 mm ² Type WFLA 2.5
Length:	0.5 m, high flex included

PE standard at No. 4 position, variations are possible.

Dimensions of base plate see KDS2/40.

PE makes contact first when entering conductors.

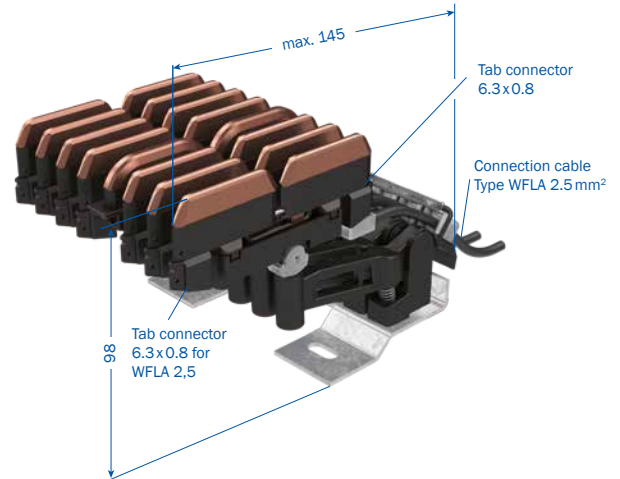

Type	No. of poles	Weight kg	Base plate	Order No.	
				with PE-VP	with PE Standard
SA-KUFR2/40/4/14VP0.5/4/4	4	0.448	4-pole	144474	-
SA-KUFR2/40/4/14HS0.5/4/4	4	0.448	4-pole	-	165927
SA-KUFR2/40/5/14VP0.5/4/6/6	5	0.573	6-pole (No. 6 = open)	144475	-
SA-KUFR2/40/5/14HS0.5/6/6	5	0.573	6-pole (No. 6 = open)	-	165928
SA-KUFR2/40/6/14VP0.5/4/6	6	0.666	6-pole	144476	-
SA-KUFR2/40/6/14HS0.5/6	6	0.666	6-pole	-	165929
SA-KUFR2/40/7/14VP0.5/4/8/8	7	0.779	8-pole (No. 8 = open)	144478	-
SA-KUFR2/40/7/14HS0.5/8/8	7	0.779	8-pole (No. 8 = open)	-	165930
SA-KUFR2/40/8/14VP0.5/4/8	8	0.872	8-pole	144479	-
SA-KUFR2/40/8/14HS0.5/8	8	0.872	8-pole	-	165931
SA-KUFR2/40/9/14VP0.5/4/10/10	9	1.004	10-pole (No. 10 = open)	144480	-
SA-KUFR2/40/9/14HS0.5/10/10	9	1.004	10-pole (No. 10 = open)	-	165932
SA-KUFR2/40/10/14VP0.5/4/10	10	1.097	10-pole	144481	-
SA-KUFR2/40/10/14HS0.5/10	10	1.097	10-pole	-	165933
Single conductor available with 0.5 m connecting cable				Phase, black	PE, yellow
SA-KUFR2/40/20PH-88/15-0.5		0.093		165955	-
SA-KUFR2/40/20PE-88/15-0.5		0.091		-	165956
SA-KUFR2/40/04VP-79/15-0.5		0.105		-	143776

CURRENT COLLECTOR SETS (TRAILING UNIT)

Single conductor on base plate. PE standard at No. 4 position, variations possible!

Type	Dim. a mm	Dim. b mm	Dim. c mm	Weight kg	Base plate	Order No. PE-VP	Order No. PE
SA-KUFR2/40/1/14VP0.5/4/4/1-3	28	62	-	0.164	4-pole	143774	-
SA-KUFR2/40/1/14HS0.5/4/4/1-3	28	62	-	0.164	4-pole	-	166491
SA-KUFR2/40/1/14VP0.5/4/6/1-3U5-6	56	90	-	0.197	6-pole	143836	-
SA-KUFR2/40/1/14HS0.5/4/6/1-3U5-6	56	90	-	0.197	6-pole	-	167573
SA-KUFR2/40/1/14VP0.5/4/8/1-3U5-8	80	118	53	0.216	8-pole	144482	-
SA-KUFR2/40/1/14HS0.5/4/8/1-3U5-8	80	118	53	0.216	8-pole	-	167661

ENTRY FUNNEL

EFT10

for current collector KUFU25 and KESR32

to be used with current collector KUFU25 or KESR32

Please note: Entry funnel without current.

Entry speed: max. 100 m/min
 Entry tolerance: horizontal: ± 10 mm
 vertical: ± 10 mm

Version with PE-VP please inquire; KESR required KESR

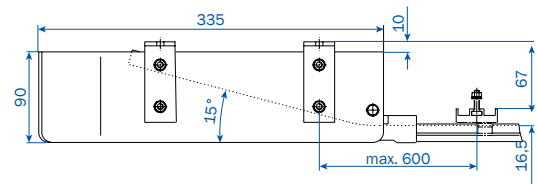
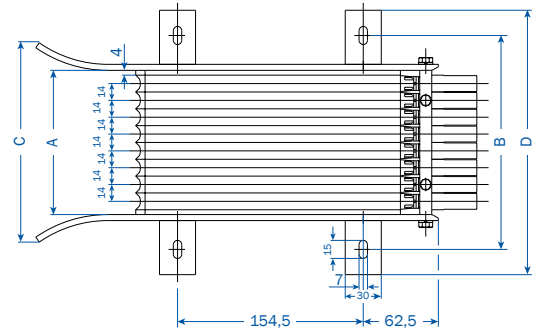

Type	No. of poles	Dim. A mm	Dim. B mm	Dim. C mm	Dim. D mm	Weight kg	Order No.
MU-EFT10-2-KUFU	2	36	94	82	136	1.145	167675
MU-EFT10-3-KUFU	3	50	108	96	150	1.230	167676
MU-EFT10-4-KUFU	4	64	122	110	164	1.315	167677
MU-EFT10-5-KUFU	5	78	136	124	178	1.400	167678
MU-EFT10-6-KUFU	6	92	150	138	192	1.485	167679
MU-EFT10-7-KUFU	7	106	164	152	206	1.570	167680
MU-EFT10-8-KUFU	8	120	178	166	220	1.655	167681
MU-EFT10-9-KUFU	9	134	192	180	234	1.740	167682
MU-EFT10-10-KUFU	10	148	206	194	248	1.825	167683

COMPACT CURRENT COLLECTOR SETS

KUFU25

for entry funnel EFT10

with 1 m connecting cable type FLA 2.5

max. continuous current: 25 A

Stroke: +15 mm / -10 mm

Swivel: ±15 mm

Contact pressure: approx. 3.5 N per contact brush

PE at No. 4 position, with 3 conductors at No. 3,
with 2 conductors at No. 2. Variations are possible.
PE makes contact first when entering conductors.

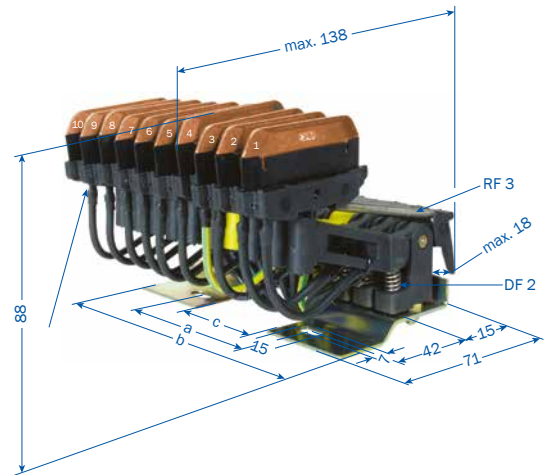

Type	No. of poles	Dim. a mm	Dim. b mm	Dim. c mm	Weight kg	Base plate	Order No.	
							with PE-VP	with PE-Standard
SA-KUFU25/2/14HS1.0/2/2	2	-	34	-	0.228	2-pole	168040	-
SA-KUFU25/2/14SS1.0/2	2	-	34	-	0.228	2-pole	-	168051
SA-KUFU25/3/14HS1.0/3/4/4	3	28	62	-	0.340	4-pole (No. 4 = open)	168041	-
SA-KUFU25/3/14SS1.0/4/4	3	28	62	-	0.340	4-pole (No. 4 = open)	-	168052
SA-KUFU25/4/14HS1.0/4/4	4	28	62	-	0.428	4-pole	168042	-
SA-KUFU25/4/14SS1.0/4	4	28	62	-	0.428	4-pole	-	168053
SA-KUFU25/5/14HS1.0/4/6/6	5	56	90	-	0.549	6-pole (No. 6 = open)	168043	-
SA-KUFU25/5/14SS1.0/6/6	5	56	90	-	0.549	6-pole (No. 6 = open)	-	168054
SA-KUFU25/6/14HS1.0/4/6	6	56	90	-	0.637	6-pole	168044	-
SA-KUFU25/6/14SS1.0/6	6	56	90	-	0.637	6-pole	-	168055
SA-KUFU25/7/14HS1.0/4/8/8	7	80	118	53	0.744	8-pole (No. 8 = open)	168045	-
SA-KUFU25/7/14SS1.0/8/8	7	80	118	53	0.744	8-pole (No. 8 = open)	-	168056
SA-KUFU25/8/14HS1.0/4/8	8	80	118	53	0.832	8-pole	168046	-
SA-KUFU25/8/14SS1.0/8	8	80	118	53	0.832	8-pole	-	168057
SA-KUFU25/9/14HS1.0/4/10/10	9	80	146	53	0.959	10-pole (No. 10 = open)	168047	-
SA-KUFU25/9/14SS1.0/10/10	9	80	146	53	0.959	10-pole (No. 10 = open)	-	168058
SA-KUFU25/10/14HS1.0/4/10	10	80	146	53	1.047	10-pole	168048	-
SA-KUFU25/10/14SS1.0/10	10	80	146	53	1.047	10-pole	-	168059
Single conductor available, without connecting cable							Phase, black	PE, yellow
SA-KUFU25/28PH-78/15-0.0					0.051		168015	-
SA-KUFU25/28PE-78/15-0.0					0.051		-	168016

CARBON BRUSHES

width of contact brushes = 3.8 mm

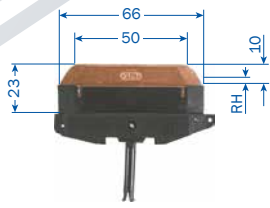

SK-KMKU25-20-14

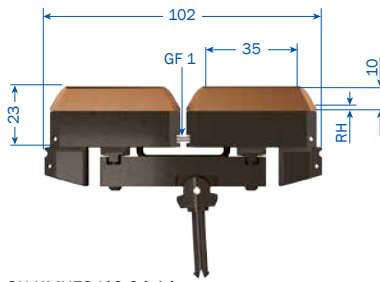

SK-KMKF2/40-04-14

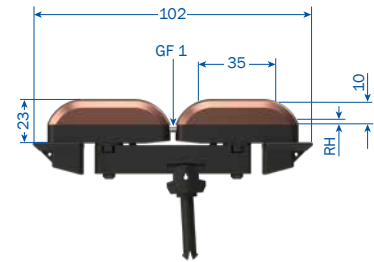

KMKF2/40VP-04-14

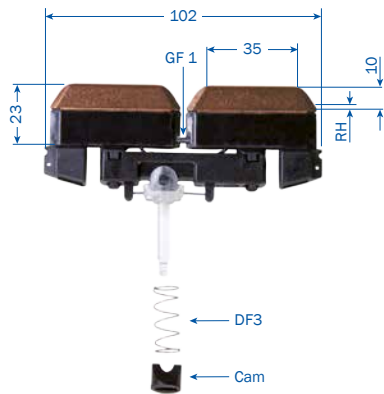

SK-DSW2/40-04-14-FN

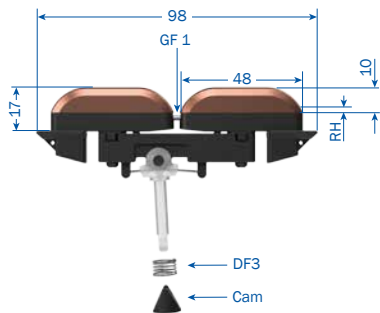

SK-DSW2/40VP-04-14-FN

Min. remaining brush height (RH) = 3 mm

Type	for current collector	Weight kg	Order No.
SK-KMKU25-20-14	KUFU25	0.030	168284
SK-DSW2/40-04-14-FN	KDS2/40	0.049	168151
SK-DSW2/40VP-04-14-FN	KDS2/40 Ground-VP	0.060	144059
SK-KMKF2/40-04-14	KUFR2/40	0.050	144277
SK-KMKF2/40VP-04-14	KUFR2/40VP	0.060	143777

SPRINGS

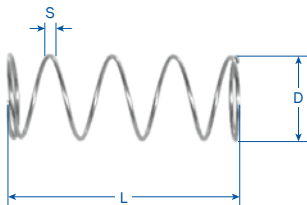

Compression spring DF3

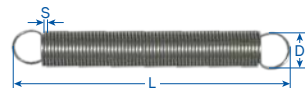

Tension spring RF3



Alignment spring GF1



Cam

Type	for current collector	S mm	D mm	L mm	Order No.
DF3	KDS2/40	0.55	9.55	24.00	152011
RF3	KUFU25, KUFR2/40	0.40	4.40	31.00	153849
GF1	KDS2/40, KUFR2/40	-	2.00	21.50	153850
NOCKEN	KDS2/40				1011917

CONNECTING CABLES

CONNECTING CABLE, HIGHLY FLEXIBLE

for current collector, feed terminal, transfer guide and isolating assembly
(for current collector KDS and KUFR use connecting cable WFLA 2.5)



WFLA



FLA/FKA

FH

CONNECTING CABLE, DOUBLE INSULATED

for current collector or feed terminal

Length: 0.5 m with tab plug 6.3x0.8
Longer connecting cable available

Length: 1 m with tab plug 6.3x0.8
Longer connecting cable available

Type	Cross section mm ²	Ø mm		Weight kg		Order No. Phase black	Order No. PE green/yellow
		PH	PE	PH	PE		
AL-FLA2.5PH1-6.3	2.50	3.9	-	0.037	-	165049	-
AL-FLA2.5PE1-6.3	2.50	-	3.6	-	0.035	-	165050
AL-FLA4PH1-6.3	4.00	5.4	-	0.064	-	165051	-
AL-FLA4PE1-6.3	4.00	-	5.2	-	0.059	-	165052
AL-FLA6PH1-6.3	6.00	5.7	-	0.086	-	166368	-
AL-FLA6PE1-6.3	6.00	-	5.7	-	0.083	-	166369
AL-WFLA2.5PH0.5-6.3	2.50	3.9	-	0.020	-	168107	-
AL-WFLA2.5PE0.5-6.3	2.50	-	3.6	-	0.018	-	168108

CONNECTING CABLE, SINGLE INSULATION

for isolating assembly only

Type	Cross section mm ²	Ø mm		Weight kg		Order No. Phase black	Order No. PE green/yellow
		PH	PE	PH	PE		
AL-IFKA1.5PH1-6.3	1.50	3.0	-	0.020	-	166557	-
AL-IFKA1.5PE1-6.3	1.50	-	3.0	-	0.020	-	166558
AL-IFKA2.5PH1-6.3	2.50	3.7	-	0.032	-	166238	-
AL-IFKA2.5PE1-6.3	2.50	-	3.7	-	0.032	-	166239
AL-IFKA4PH1-6.3	4.00	4.3	-	0.050	-	166240	-
AL-IFKA4PE1-6.3	4.00	-	4.3	-	0.050	-	166241
AL-IFKA6-PH1-6.3	6.00	4.9	-	0.064	-	166242	-
AL-IFKA6-PE1-6.3	6.00	-	4.9	-	0.064	-	166243

TAB PLUG ONLY (WITHOUT CABLE)

Type	for cable cross section mm ²	Weight kg	Order No.
FH2.5	2.5	0.002	165120
FH4-6	4-6	0.002	165121
WFH2.5	2.5	0.002	168109

TERMINAL BOXES

TERMINAL BOX AKE

for conductor current supply with max. 7 x 6 mm² terminal clamps and 2 x 6 mm² PE terminal clamps.

Please inquire when terminal clamp variations are desired.

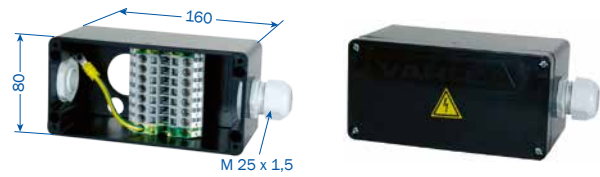

Type	Weight kg	Order No.
ES-AKE1-PH7 x 2L6-PE2 x 2L6-M25	0.445	169462

BRUSH WEAR INDICATOR

Brush wear indicator can be supplied installed on 0.5 m conductor section. Please specify the corresponding conductor arrangement when ordering.

The brush wear indicator checks the remaining brush height each time a collector set passes. Max. travel speed 70 m/min. When the remaining brush height reaches the preset value of 3 mm the brush wear indicator will send an impulse. It is practical to install the brush wear indicator ahead of a track switch, then the impulse can actuate the track switch to send the unit directly into a maintenance spur.

An opening, min. width 70 mm height 50 mm, must be cut at the EMS track web. PE position is variable, similarly to the conductor arrangement; please inquire. Differing remaining brush height settings above 3 mm are also available.

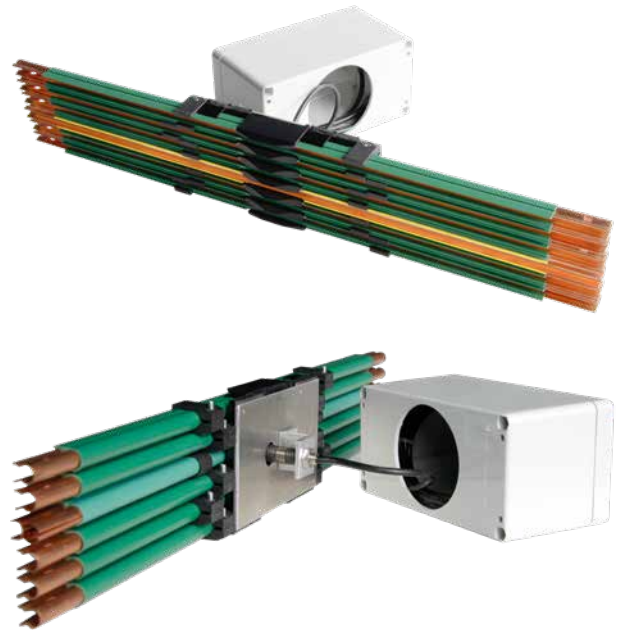

BRUSH WEAR INDICATOR WITH INDUCTIVE PROXIMITY SWITCH

The last slot of a brush wear indicator with an uneven number of conductors remains unoccupied.

Type	Number of poles	Weight kg	Order No. PE-VP at No. 4	Order No. PE at No. 4
VT-KVT10-4-14VP4B	4	2.011	143637	-
VT-KVT10-4-14HS4B	4	2.011	-	166957
VT-KVT10-5-14VP4B/6	5	2.252	144093	-
VT-KVT10-5-14HS4B/6	5	2.252	-	167440
VT-KVT10-6-14VP4B	6	2.453	143304	-
VT-KVT10-6-14HS4B	6	2.453	-	166895
VT-KVT10-7-14VP4B/8	7	2.692	143466	-
VT-KVT10-7-14HS4B/8	7	2.692	-	167441
VT-KVT10-8-14VP4B	8	2.893	143646	-
VT-KVT10-8-14HS4B	8	2.893	-	166896
VT-KVT10-9-14VP4B/10	9	3.131	144094	-
VT-KVT10-9-14HS4B/10	9	3.131	-	167442
VT-KVT10-10-14VP4B	10	3.335	144095	-
VT-KVT10-10-14HS4B	10	3.335	-	166897

INSTALLATION TOOLS

CURVE TOOL

for forming U10 vertical and horizontal curves.

Filler Rods must be ordered separately.



Type	Description	Weight kg	Order No.
MZ-BVU10-VP	Curve tool	6.918	143318
MZ-FU10-V ⁽¹⁾	Filler rod for PH/PE (4 m)	0.371	165234
MU-FU10-H ⁽²⁾	Filler rod for PH/PE (4 m)	0.354	144416
MZ-FU10-S-VP	Filler rod for PE-VP hollow body (4 m)	0.156	143279
MZ-FU10-VP-E	Filler rod for PE-VP contact surface (4 m)	0.208	143280

TABLE SAW

for cutting U10 insulator profiles and conductor profiles, with length stop

Voltage required: 230V, 50Hz



Type	Description	Weight kg	Order No.
MZ-KS10	Table saw, complete	6.500	165276
MZ-SB	Spare saw blade	0.070	165263

CONDUCTOR PUNCH TOOL

for punching joint splice window into conductor profile after cutting standard length section.

For phase and PE and PE-VP conductors.



Standard PH/PE

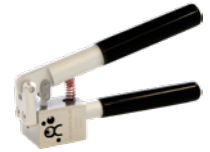

PE-VP

Type	Description	Weight kg	Order No.
MZ-LZ10PE-VP	Conductor punch tool for PE-VP	0.595	143223
MZ-LZ10PH/PE	Conductor punch tool for Phase and Standard PE	0.480	144363

DEBURRING FILE



RF



HRF

Type	Application	Weight kg	Order No.
ROUND FILE RF-150 LONG/HIEB 3/ D = 6 mm	Deburr inside profile after cutting section	0.085	143330
HALF ROUND FILE HRF-150 LONG/ HIEB 3	Deburr outside profile after cutting section	0.085	165264

ADJUSTMENT JIG

facilitates cutting precise length of insulation profile without using measuring tape.



Type	Weight kg	Order No.
MZ-ST10	0.150	165091

(1) For making vertical EMS curve sections.

(2) For making horizontal and outward facing AEM curve sections.

JOINT SPLICE/FEED ASSEMBLING TOOL

To push conductor into joint splice clip

If necessary, to widen conductor slot opening

To move joint splice cap in place



Type	Weight kg	Order No.
MZ-MG-SW10	0.125	165093

LOCKING PIN DRIVER

to insert BFU anchor bar transfer guide locking pins



Type	Weight kg	Order No.
MZ-ED10	0.010	165277

CONDUCTOR REMOVAL TOOL

to release and remove conductors from compact hangers



Type	Weight kg	Order No.
MZ-DMW10	0.039	165119

DRILLING JIG FOR FIX POINT (PE-VP)



Type	Weight kg	Order No.
MZ-BS10A	0.036	143425

SPIRAL DRILL

to drill holes for locating clamps USK 10A-VP at fix points



Type	Weight kg	Order No.
SPIRAL DRILL Ø 3.2 MM, Type N	0.003	143426

INSTALLATION TOOL BOX

includes 1x BVU10-VP curve Tool, with filler rods 1x FU10,
 1x FU10S-VP and 1x FU10VP-E, 1x KS10 table saw, 1x SB spare blade,
 1x LZ10PE-VP and 1x LZ10PH/PE conductor punch tool, 1x RF round file
 and 1x HRF half round file, 1x ST10 adjustment jig, 1x MG-SW 10 joint splice/feed assembly tool,
 1x ED10 locking pin driver, 1x DMW10 conductor removal tool,
 1x BS10A drilling jig, 1x spiral drill Ø 3.2 mm
 Installation tool box can be locked.

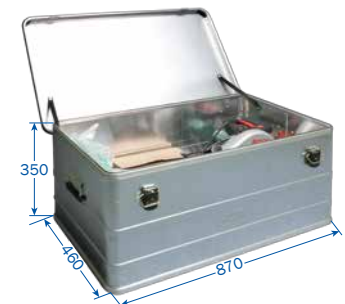

Type	Weight kg	Order No.
MZ-MWK-K	26.500	166548

APPLICATION QUESTIONNAIRE FOR U10

Customer _____ Date _____
 Final customer _____ Projekt No. _____
 Installation _____

CUSTOMER CONTACT

	Name	Fon	E-mail
Technical planning			
Purchasing			

SCOPE OF SUPPLY

vCONDUCTOR vPOS vCOM vDRIVE
 Installation VAHLE components Installation Non-VAHLE components _____
 Disassembly Disassembly Non-VAHLE components _____

SCHEDULE

Proposal submittal _____ week/date Delivery _____ week/date
 Installation start _____ finish _____ week/date Weekdays Weekends

MECHANICAL DATA

1. Installation concept

New installation
 Alteration / Expansion Original Conductor System Delivery No.: _____
 Replacement 1:1 Original Conductor System Delivery No.: _____

2. Type of application

EMS
 Floor track systems (2 tracks)
 Skillet system
 Other

3. Carrier track / Carrier track supplier / Track designation

180x60 / _____ / _____
 240x80 / _____ / _____
 Other _____ / _____ / _____

4. Conductor orientation

Facing sideways In direction of travel: Right Left
 Facing downward

5. Installation height

Off facility floor or support floor _____ mm Freely traversible

6. Track expansion gaps

Expansion distance / gap dimension _____ mm

7. Building expansion gaps

Expansion distance/ gap dimension _____ mm

8. Specific building features

ELECTRICAL DATA

9. Operating voltage

Three-phase voltage AC Voltage DC voltage _____ V _____ Hz

10. Type of conductor

- U10/25C copper conductor
- U10/25E stainless steel conductor

11. Number of conductors (poles)

Main current _____ Control current _____ Ground (PE) standard _____
 PE-VP Ground conductor with phase collector avoidance protection available only in copper _____

12. Conductor sequence

Compact hanger number of conductors _____ Location top to bottom:

Pole	Position	Example 12-pole hanger 6-pole used
1.		open
2.		open
3.		L1
4.		L2
5.		L3
6.		PE-VP
7.		S1
8.		S2
9.		open
10.		open
11.		open
12.		open

13. Travel mode

One direction only Bi-directional _____ / _____ %

14. Travel speeds

Travel speed V max. straight: _____ m/min

Travel speed V max. curve: _____ m/min

Acceleration _____ m/s²

Acceleration time _____ s

NOTES

A large grid of small dots for taking notes, covering most of the page. The dots are arranged in a regular pattern, forming a grid that is approximately 30 columns wide and 40 rows high. The dots are light gray and spaced evenly across the page.



Paul Vahle GmbH & Co. KG

Westicker Str. 52
59174 Kamen
Germany

Tel.: +49 2307 704-0
Fax: +49 2307 704-444
info@vahle.de

www.vahle.com