



AcuGrind

High precision air chucks

Chuck sizes \varnothing 80 - 250 mm

- For OD and ID clamping
- Built-in pneumatic actuation, no hydraulic cylinder required
- For universal grinding applications

- with built-in pneumatic actuating cylinder
- fully sealed



Application/customers benefits

- Sealed standard chuck for high-precision grinding
- Highest accuracy - runout and repeatability
- Built-in pneumatic actuation, no hydraulic cylinder required

Technical features

- Base jaws case hardened
- Repeatability < 0.002 mm
- **proofline® chucks** = fully sealed - low maintenance

Standard equipment

- Power chuck
- Boring ring for I.D. clamping
- Boring ring for O.D. clamping
- Lubricating oil

Ordering example

AcuGrind 150, Id.No. 5302503

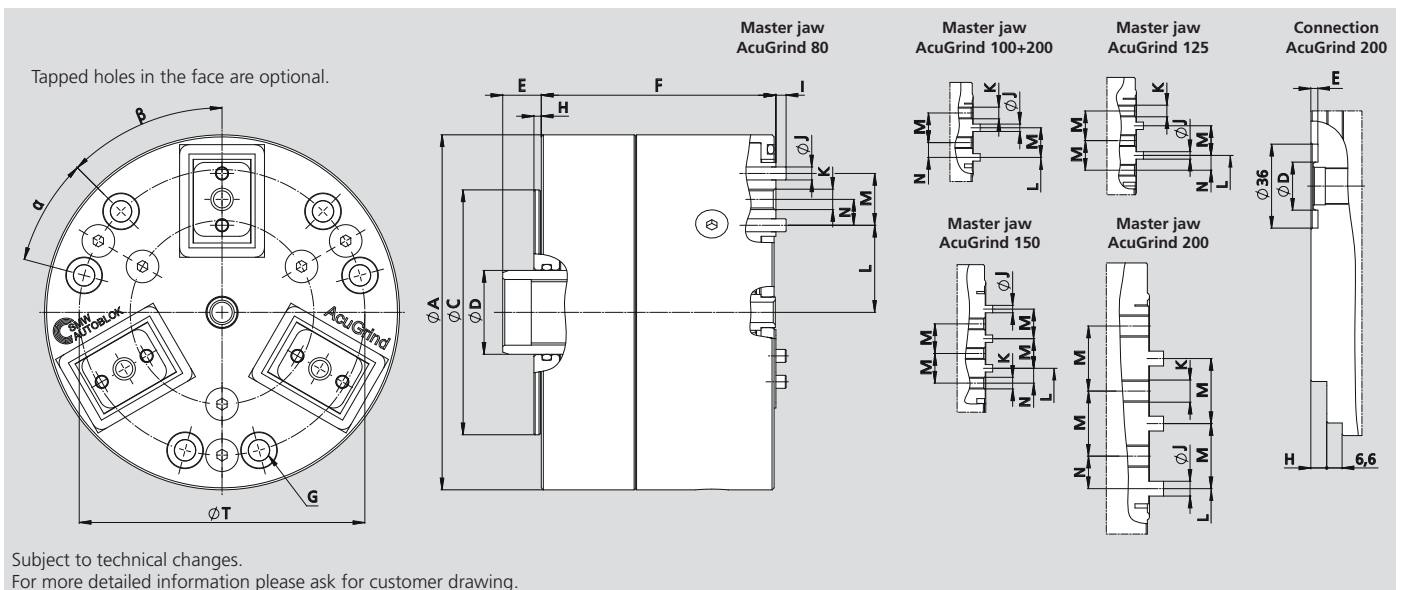

Technical data

SMW-AUTOBLOK Type		AcuGrind 80	AcuGrind 100	AcuGrind 125	AcuGrind 150	AcuGrind 200	AcuGrind 250
Order number	Id. No.	5302500	5302501	5302502	5302503	5302504	5302505
Outside Ø	A	87	107	135	157	214	265
Centering Ø	C	60	82.55	101.6	125	167.6	215.8
Distributor Ø	D	20.55	20.55	20.6	20.6	20.6	20.6
min. / max.	E	9.5 / 17.0	10 / 17.5	8 / 15.5	10.5 / 18	-3 / 10.5	12.75 / 20.25
Height	F	57.5	56.5	60.3	56.2	81.5	74.6
Chuck mounting bolts	G	6 x M5	6 x M5	6 x M6	6 x M6	6 x M10	6 x M10
	H	1.8	2	2.2	2.2	6.8	7.2
	I	2.5	3.2	3.2	3.2	6.35	6.35
Pin Ø	J	3.18	3.18	3.18	3.18	6.35	6.35
Jaw mounting bolts	K	M5	M5	M5	M5	3/8" - 24 UNF	3/8" - 24 UNF
Distance to 1. pin max. / min.	L	21.34 / 20.09	21.34 / 20.09	34.05 / 32.8	34.05 / 32.8	38.05 / 36.8	35.7 / 34.45
	M	12.7	12.7	12.7	12.7	27.9	27.9
	N	6.35	6.35	6.35	6.35	13.95	13.95
Bolt circle Ø	T	70	88.9	110	135.75	183	233.7
	α	30°	6 x 60°	6 x 60°	6 x 60°	6 x 60°	6 x 60°
	β	45°	30°	30°	30°	30°	30°
Repeatability	mm	< 0.002	< 0.002	< 0.002	< 0.002	< 0.002	< 0.002
Radial jaw stroke	mm	1.25	1.25	1.25	1.25	1.25	1.25
Speed max.	min ⁻¹	1500	1000	900	900	900	800
Clamping force at 6 bar	kN	2.65	4.85	9.5	10.5	28	31
Operating pressure	bar	1 - 6	1 - 6	1 - 6	1 - 6	1 - 6	1 - 6
Weight	kg	2.5	3.5	6.5	7.5	21	28

2-jaw and 4-jaw power chucks available on request.

Top jaws for AcuGrind

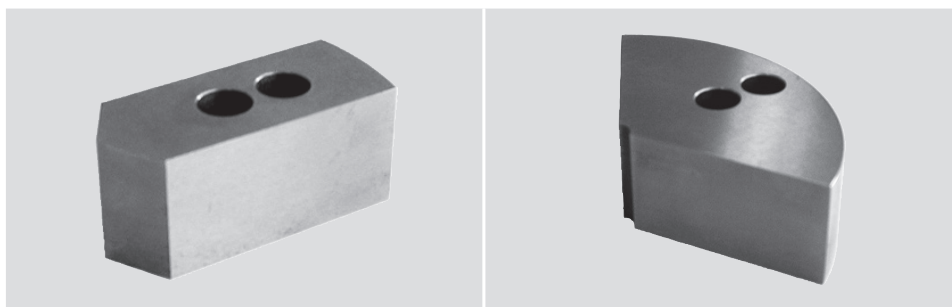

Chuck type	Material	WAK Soft top jaws		SBK Segment jaws 120°	
		Id. No.	Height	Id. No.	Height
AcuGrind 80	Aluminium	5302511	25	5302545	25
		5302512	38	5302546	38
	Steel	5302513	25	5302547	25
		5302514	38	5302548	38
AcuGrind 100	Aluminium	5302515	25	5302549	25
		5302516	38	5302550	50
				5302551	75
				5302552	100
	Steel	5302517	25	5302553	20
		5302518	38	5302554	38
5302519		50	5302555	50	
AcuGrind 125	Aluminium	5302520	25	5302556	25
		5302521	38	5302557	38
		5302522	50	5302558	50
		5302523	75	5302559	75
	Steel	5302524	25	5302560	20
		5302525	38	5302561	25
		5302526	50	5302562	38
				5302563	50
AcuGrind 150	Aluminium	5302527	25	5302564	25
		5302528	38	5302565	38
		5302529	50	5302566	50
		5302530	75	5302567	75
				5302568	100
	Steel	5302531	25	5302569	25
		5302532	38	5302570	38
		5302533	50	5302571	50
		5302534	75	5302572	75
AcuGrind 200	Aluminium	5302535	50	5302573	38
		5302536	75	5302574	50
		5302537	100	5302575	75
	Steel	5302538	50	5302576	50
		5302539	75	5302577	75
		5302540	100		
AcuGrind 250	Aluminium	5302541	50	5302578	75
		5302542	75	5302579	100
	Steel	5302543	50	5302580	75
		5302544	75	5302581	100

Top jaws in special version on request.

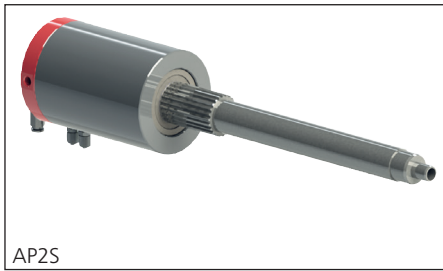

AP2S

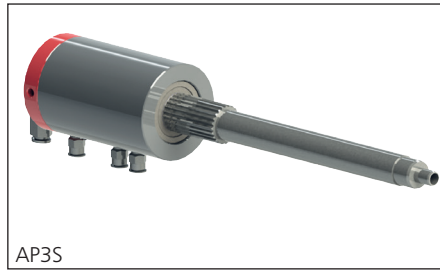

AP3S

SMW-AUTOBLOK Type	Speed max. (min ⁻¹)	Version
AP2S	5.000	2 airways
AP3S	5.000	3 airways

AP2S/AP3S = with serration

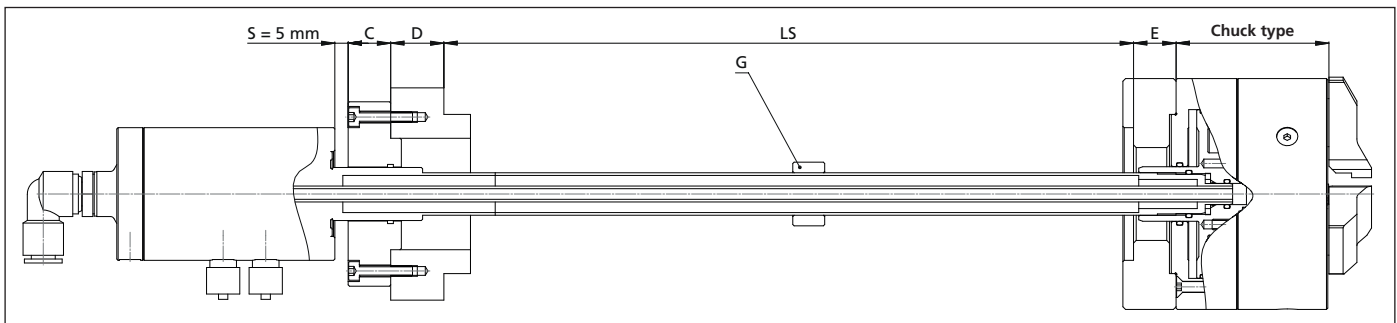

LS	Spindle length
E	Chuck adaptor
C	Bushing (included in scope of delivery of the air feed tubes type AP)
D	Adaptor (mounting ring manufactured by the customer)
S	Safety distance
F	AcuGrind chuck
G	Support ring for tube bundle longer 600mm

Ordering example

NOTE In case of an order of the air feed tubes type AP, the length of the air feed tube is necessary.

For calculating the correct length of the air feed tube (LR) are the following dimensions necessary: LS, E, C, D and the chuck type!

NOTE Use only with clean and oiled air.

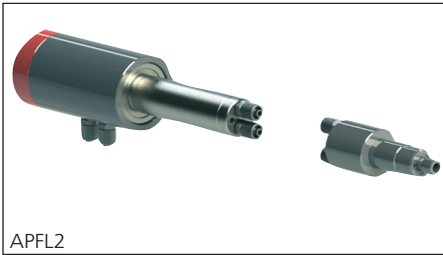

APFL2

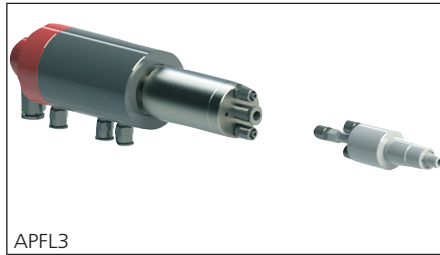

APFL3

SMW-AUTOBLOK Type	Id. No.	Speed max. (min ⁻¹)	Version
APFL2	5302594	6.000	2 airways
APFL3	5302595	6.000	3 airways



PH 6-2 / PH 6-3

SMW-AUTOBLOK Typ	PH 6-2	PH 6-3
Id.-Nr.	5302585	5302586
Number of airways	2	3
Airways outside Ø (mm)	6	6
Airways inside Ø (mm)	4	4
Medium	air	air
Max. operating pressure (MPa) at 20 °C	0.8	0.8
Operating temperature	-20 °C - +60 °C	-20 °C - +60 °C
Length (mm)	525	505
Max. working distance (mm)	1.500	1.000
Outside Ø coil (mm)	37	37
Material	Polyurethan	Polyurethan
Colour	black	black

