

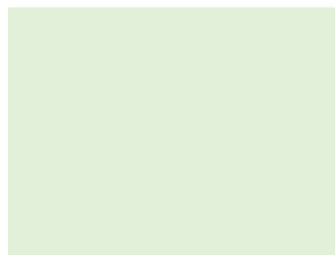

佛山凯力照明科技有限公司

Foshan Kaili Lighting Technology Co., Ltd

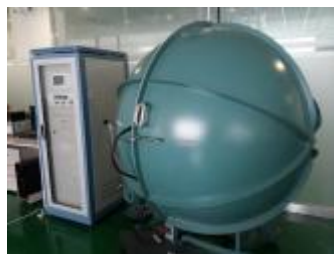
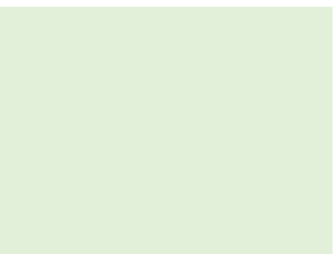
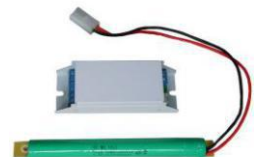
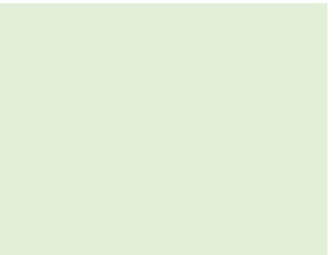
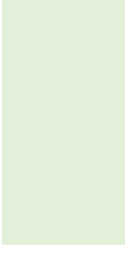

Deluxe Emergency Twin-Spotlight



YJFe001

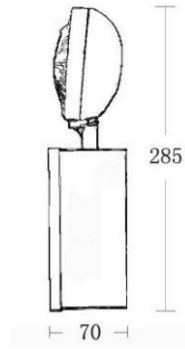
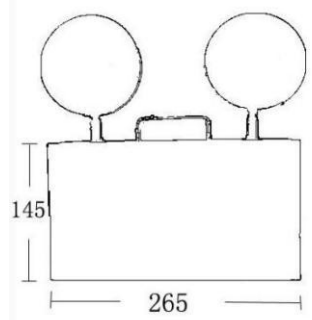

YJFe002

High-end LED two head emergency lights are used in airport, subway, police station and various municipal sites for its **2hrs' constant ultra bright** performance.

Technical Specifications:

- Lamp source: LED source, which is energy-saving, illuminated, long-life LED use only 3 watts of power, lowering your energy consumption and saving you money every month
- Main Voltage/Frequency: AC220V(+/-10%)/50-60Hz
- Source Power: 2*3 Watt; 2*1 Watt
- Emergency Output: **420lumens** (2*3W) ; **150lumens** (2*1W)
- Battery Capacity & Voltage: Ni-MH 6V/2500mAh(2*3W); Ni-MH 3.6V/1300mAh(2*1W)
- Discharge time: 2 hours, always **Keeping ultra bright** in 2 hours!
- Material: White, corrosion-resistant metal housing+steel light handle, adjustable lighting heads
- Dimension: 265*70*145mm (box only LxWxH), wall-mounted

Special development and customer's solutions on request.



Specifications:

Code	YJFe001	YJFe002
Name	Deluxe 2x3W Led Twin-Spotlight	Deluxe 2x1W Led Twin-Spotlight
Dimension		
Size:box only(LxWxH)	265*70*145mm	
Size:box with light(LxWxH)	265*70*285mm	
Material		
Construction of Twin-Spotlight	Metal	
Material(box)	White corrosion-resistant metal housing+ Plastic spraying	
Parameter		
Main Voltage/Frequency	AC 220V(+/-10%)/50-60Hz	
System Mode	Non-maintained Type	
Source Power	LED 2x3W	LED 2x1W
Battery Capacity & Voltage	Ni-MH 6V; 2500mAh	Ni-MH 3.6V; 1300mAh
Battery	Sealed Nickel Metal Hydride (NI-MH) rechargeable battery	
Power Factor	0.5	
Power	3W	
Color Temperature	4000K	
Luminous Flux	420lm	150lm
Operating Temperature	-10°C-55°C	
Emergency Conversion Kit	Built-in type (constant bright)	
Lifespan	35,000 hours	
Discharge Duration	2 hours	
Charging Time	24 hours	
Emergency Starting Time	<0.3s	
Installation Way	Wall mounted	
Full Charge Indicator	From Red to Green LED	
A.C. Supply Indicator	Red LED	
Fault Indicator	Flashing Yellow LED(Battery Defected/Source Power Burnt)	
Test Button	Press type	
Low Voltage Protection	Electronic Protection(approx. 1V/cell)	
Guarantee Period	1 year	

Medium Grade Emergency Twin-Spotlight



YJFe003

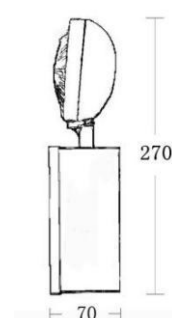
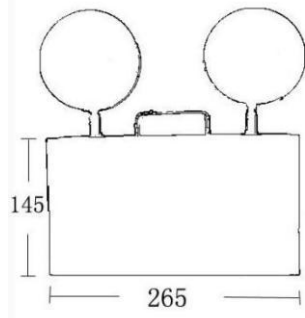

YJFe004

Surface mounted, non-maintained type, emergency twin spot luminaire with automatic changeover device for minimum 2 hours emergency battery discharge.

Technical Specifications:

- Lamp source: LED source, which is energy-saving, illuminated, long-life LED use only 3 watts of power, lowering your energy consumption and saving you money every month
- Main Voltage/Frequency: AC220V(+/-10%)/50-60Hz
- Source Power: 2*3 Watt; 2*1 Watt
- Emergency Output: **420lumens (2*3W)** ; **150lumens (2*1W)**
- Battery Capacity & Voltage: Ni-Cd 3.6V/3800mAh(2*3W); Ni-Cd 3.6V/1300mAh(2*1W)
- Discharge time: 2 hours
- Material: White, corrosion-resistant metal housing + plastic light handle, adjustable lighting heads
- Dimension: 265*70*145mm (box only LxWxH), wall-mounted

Special development and customer's solutions on request.



Specifications:

Code	YJFe003	YJFe004
Name	Medium Grade 2x3W Led Twin-Spotlight	Medium Grade 2x1W Led Twin-Spotlight
Dimension		
Size:box only(LxWxH)	265*70*145mm	
Size:box with light(LxWxH)	265*70*270mm	
Material		
Construction of Twin-Spotlight	Metal	
Material(box)	White corrosion-resistant metal housing+Plastic spraying	
Parameter		
Main Voltage/Frequency	AC 220V(+/-10%)/50-60Hz	
System Mode	Non-maintained Type	
Source Power	LED 2x3W	LED 2x1W
Battery Capacity & Voltage	Ni-Cd 3.6v; 3800mAh	Ni-Cd 3.6v; 1300mAh
Battery	Sealed Nickel Cadmium (NI-Cd) rechargeable battery	
Power Factor	0.5	
Power	3W	
Color Temperature	6000K	
Luminous Flux	420lm	150lm
Operating Temperature	-10°C-55°C	
Emergency Conversion Kit	Built-in type	
Lifespan	35,000 hours	
Discharge Duration	2 hours	
Charging Time	24 hours	
Emergency Starting Time	<0.3s	
Installation Way	Wall mounted	
Full Charge Indicator	From Red to Green LED	
A.C. Supply Indicator	Red LED	
Fault Indicator	Flashing Yellow LED(Battery Defected/Source Power Burnt)	
Test Button	Press type	
Low Voltage Protection	Electronic Protection(approx. 1V/cell)	
Guarantee Period	1 year	

Recessed Emergency Twin-Spotlight



YJFe005

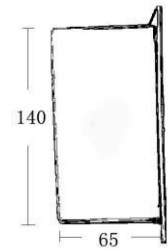
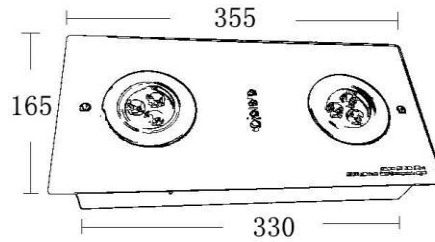

YJFe006

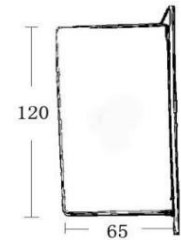
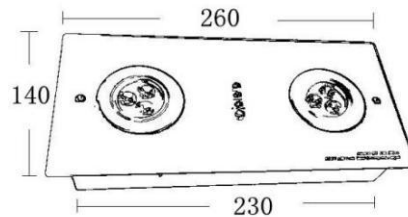

Recessed emergency lights allow for beautiful, flush architectural installations by hiding most of the emergency lighting unit within the wall or ceiling.

Technical Specifications:

- Lamp source: LED source, which is energy-saving, illuminated, long-life LED use only 3 watts of power, lowering your energy consumption and saving you money every month
- Main Voltage/Frequency: AC220V(+/-10%)/50-60Hz
- Source Power: 2*3 Watt; 2*1 Watt
- Emergency Output: **420lumens** (2*3W) ; **150lumens** (2*1W)
- Battery Capacity & Voltage: Ni-Cd 3.6v; 3800mAh(2*3W); Ni-Cd 3.6V/1300mAh(2*1W)
- Discharge time: 2 hours
- Material: White, corrosion-resistant metal housing + aluminum lighting heads
- Recessed mounted

Special development and customer's solutions on request.



Specifications:

Code	YJFe005	YJFe006
Name	Recessed 2x3W Led Twin-Spotlight	Recessed 2x1W Led Twin-Spotlight
Dimension		
Size:box only(LxWxH)	330*140*65mm	260*120*65mm
Size:front plate(LxW)	355*165mm	260*140mm
Material		
Construction of Twin-Spotlight	Aluminum	
Material(box)	White, corrosion-resistant metal housing+ Plastic spraying	
Parameter		
Main Voltage/Frequency	AC 220V(+/-10%)/50-60Hz	
System Mode	Non-maintained Type	
Source Power	LED 2x3W	LED 2x1W
Battery Capacity & Voltage	Ni-Cd 3.6v; 3800mAh	Ni-Cd 3.6v; 1300mAh
Battery	Sealed Nickel Cadmium (NI-Cd) rechargeable battery	
Power Factor	0.5	
Power	3W	
Color Temperature	6000K	
Luminous Flux	420lm	150lm
Operating Temperature	-10°C-55°C	
Emergency Conversion Kit	Built-in type	
Lifespan	35,000 hours	
Discharge Duration	2 hours	
Charging Time	24 hours	
Emergency Starting Time	<0.3s	
Installation Way	Wall mounted	
Full Charge Indicator	From Red to Green LED	
A.C. Supply Indicator	Red LED	
Fault Indicator	Flashing Yellow LED(Battery Defected/Source Power Burnt)	
Test Button	Press type	
Low Voltage Protection	Electronic Protection(approx. 1V/cell)	
Guarantee Period	1 year	

More information please browse our website: www.ledemergencylamp.com or email ph137@163.com