

Die Kellenmacher!

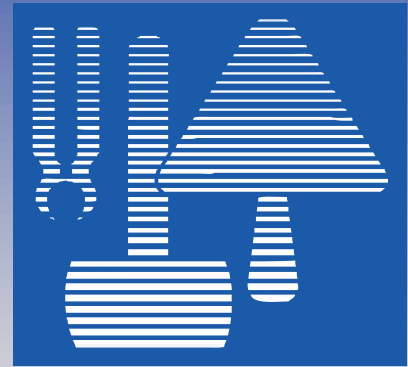

HAROMAC®
WERKZEUGFABRIK

Eine gute **HAROMAC** Kelle erkennt man an folgenden Merkmalen:

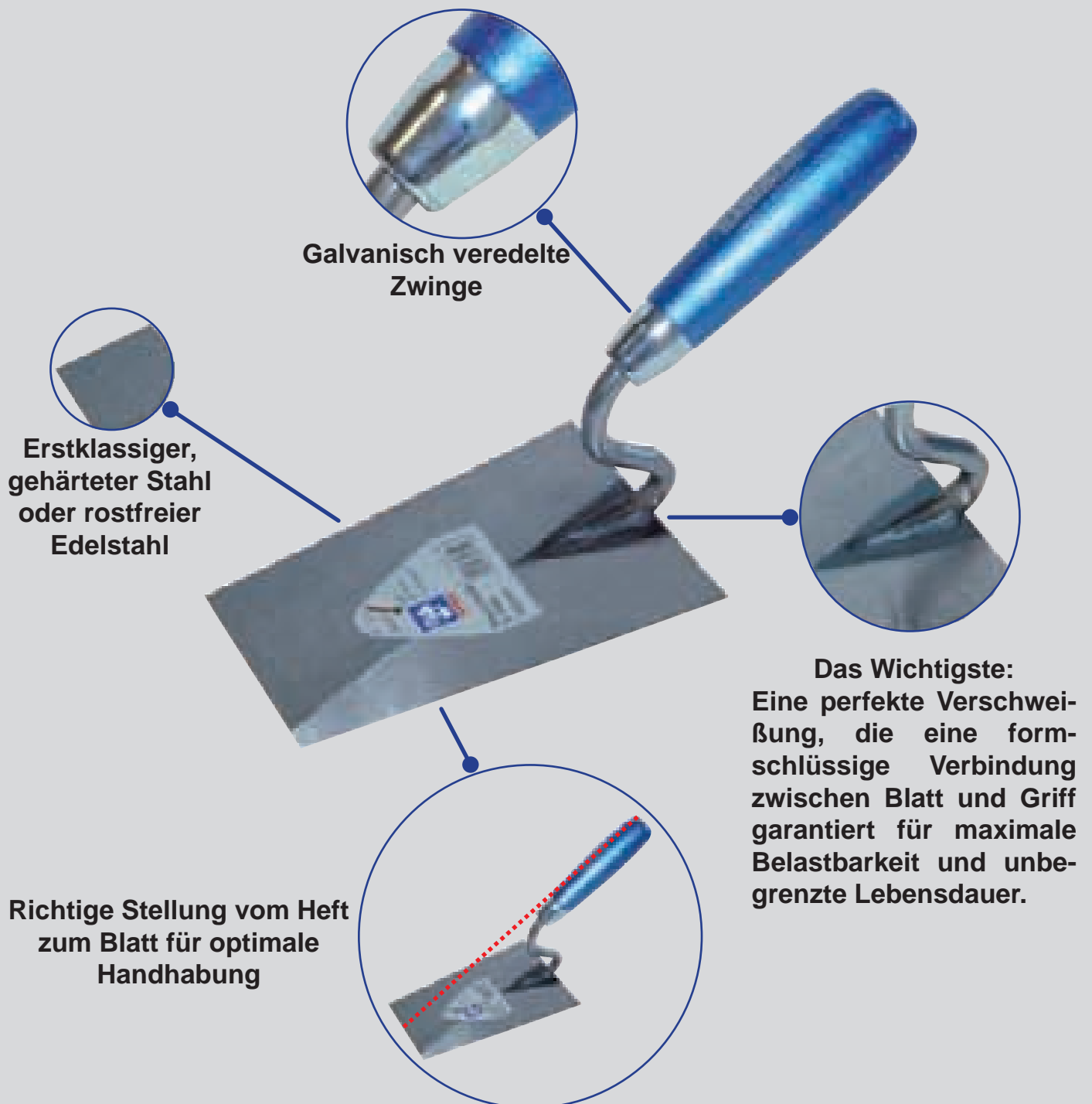

Im Zeichen der Qualität

Die Kellenmacher!
 Made in Germany



Blatt und Angel aus **rostfreiem Edelstahl**, blanke Oberfläche, Spezial-Ringverschweißung der Angel, auf dem Blatt galvanisierte Zwinge, Hartholzgriff, silberblau-metallic, fluchtende Stellung des Griffes zum Blattende, entsprechend den DIN-Vorschriften, jedes Blatt mit "HAROMAC-Rostfrei" gezeichnet.

Blade and tang are made from stainless steel, surface polished, special ringwelding between blade and tang guaranties max. strength, silverblue-metalic handle, stamped with trademark "HAROMAC -Rostfrei" on every blade.

Lame et col en acier inoxydable. La patte du col est soudée complètement sur la lame (soudure par cordon). Poignée en bois dur laquée bleu métalisé avec virole galvanisée. Extrémités de la lame et de la poignée dans la même axe. Marquage "HAROMAC-Rostfrei" imprimé sur la lame.



Art.-Nr.
 Art.-no.
 Art.-nr.

10 ...

Ölgehärtetes und konisch geschliffenes Stahlblatt, **Schweißnaht an Angel und Blatt fein geschliffen**, galvanisierte und konische Zwinge, naturbelassener Hartholzgriff, fluchtende Stellung des Griffes zum Blattende, entsprechend den DIN-Vorschriften, jedes Blatt mit "HAROMAC-Meisterklasse" gestempelt.

Oilhardened and tempered steel blade, conical ground, welding edge polished, conical and galvanized ferrule, hardwood handle, natural finish, product according to DIN standard, stamped with trademark "HAROMAC-Meisterklasse" on every blade.

Lame trempée dans l'huile et aiguisée cônica (épaisseur décroissante), soudure de la lame et du col meulé. Poignée en bois dur naturel avec virole cônica galvanisée. Extrémités de la lame et la poignée dans la même axe. Marquage "HAROMAC-Meisterklasse" imprimé sur la lame.



09 ...

Ölgehärtetes und flexibel geschliffenes Stahlblatt, Angel und Blatt sauber verschweißt, galvanisierte Zwinge, Hartholzgriff, silberblau-metallic, fluchtende Stellung des Griffes zum Blattende, entsprechend den DIN Vorschriften, jedes Blatt mit "HAROMAC-Profiklasse" gestempelt.

Oilhardened and tempered steel blade, flexible ground, blade and tang properly welded, galvanized ferrule, silverblue-metalic handle, product according to DIN standard, stamped with trademark "HAROMAC-Profiklasse" on every blade.

Lame flexible trempée dans l'huile. Col et lame soudés à haute fréquence. Poignée en bois dur laqué bleu métalisé avec virole galvanisée. Extrémités de la lame et de la poignée dans la même axe. Marquage "HAROMAC-Profiklasse" imprimé sur la lame.



11 ...

Ölgehärtetes und konisch geschliffenes Stahlblatt, **Schweißnaht an Angel und Blatt fein geschliffen**, galvanisierte Zwinge, Blatt mit Größe und Logo bedruckt, rot-schwarz lackierter Hartholzgriff, fluchtende Stellung des Griffes zum Blattende, entsprechend den DIN-Vorschriften, jedes Blatt mit "MAURERLOB" gestempelt. **Jede Kelle ist ein edles Meisterstück, so dass wir 10 Jahre Garantie gewähren!**

Oilhardened and tempered steel blade, conical ground, welding edge polished, conical and galvanized ferrule, red-black laquered hardwood handle, natural finish, product according to DIN standard, stamped with trademark "MAURERLOB" on every blade.

Lame trempée dans l'huile et aiguisée cônica (épaisseur décroissante), soudure de la lame et du col meulé. Poignée en bois dur naturel avec virole cônica galvanisée. Extrémités de la lame et la poignée dans la même axe. Marquage "MAURERLOB" imprimé sur la lame.



99 ...



Die Kellenmacher!

















Made in Germany

Mauerkellen

Trowel
Truelle

Mauerkelle mit S-Hals (Tiroler Stukkateurkelle)

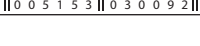
Mason's trowel, German-type, swan's neck
Truelle de maçon avec col de cygne

Art.-Nr.	L/mm	B1/mm	B2/mm		
09 020 160	160	85	115	5 4	
09 020 180	180	95	125	5 4	
09 020 200	200	105	140	5 4	
09 020 220	220	110	140	5 4	
09 907 020	160	85	115	5 4	
09 907 021	170	85	115	5 4	
09 907 022	180	95	125	5 4	
09 907 024	200	105	140	5 4	
09 907 025	220	110	140	5 4	
11 020 160	160	85	115	5 4	
11 020 180	180	95	125	5 4	
11 020 200	200	105	140	5 4	
11 020 220	220	110	140	5 4	
10 020 160	160	85	115	5 4	
10 020 180	180	95	125	5 4	
10 020 200	200	105	140	5 4	







Neu



Wichtiger Sortimentsartikel!

Mauerkelle mit S-Hals, vorne abgerundet





Mason's trowel, German-type, swan's neck, round blade
Truelle de maçon avec col de cygne et bout rond

Art.-Nr.	L/mm	B1/mm	B2/mm		
09 230 180	180	95	125	5 4	
11 230 180	180	95	125	5 4	
10 230 180	180	95	125	5 4	

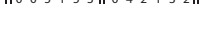

Mauerkelle mit geradem Hals vorne abgerundet

Mason's trowel, German-type, straight neck
Truelle de maçon avec col droit, bout rond

Art.-Nr.	L/mm	B1/mm	B2/mm		EAN
09 231 180	180	95	125	5 4	
11 231 180	180	95	125	5 4	
10 231 180	180	95	125	5 4	



Maurerkellen

Trowel
Truelle





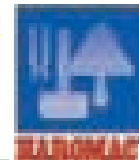











Die Kellenmacher!

Made in
Germany



Maurerkelle mit geradem Hals (Tiroler Stukkateurkelle)

Mason's trowel, German-type, straight neck
Truelle de maçon avec col droit

Art.-Nr.	L/mm	B1/mm	B2/mm		EAN
09 021 160	160	85	115	5 4	
09 021 180	180	95	125	5 4	
09 021 200	200	105	140	5 4	
09 021 220	220	110	140	5 4	
09 907 010	160	85	115	5 4	
09 907 012	180	95	125	5 4	
09 907 014	200	105	140	5 4	
09 907 015	220	110	140	5 4	
11 021 160	160	85	115	5 4	
11 021 180	180	95	125	5 4	
11 021 200	200	105	140	5 4	
11 021 220	220	110	140	5 4	
10 021 160	160	85	115	5 4	
10 021 180	180	95	125	5 4	
10 021 200	200	105	140	5 4	

Neu























EDELSTAHL
Rost
frei

Wichtiger Sortimentsartikel!



Berliner Maurerkelle

Mason's trowel, Berlin-type
Truelle de maçon, type Berlin

Art.-Nr.	L/mm	B/mm		EAN
09 027 180	180	160	5 4	
09 027 200	200	175	5 4	
09 027 210	210	190	5 4	
09 027 220	220	200	5 4	
09 027 230	230	205	5 4	
09 027 240	240	213	5 4	
09 027 260	260	230	5 4	
09 904 010	180	160	5 4	
09 904 011	200	175	5 4	
09 904 012	210	190	5 4	
09 904 013	220	200	5 4	
09 904 014	240	210	5 4	
09 904 015	260	230	5 4	
09 904 016	280	240	5 4	
11 027 180	180	160	5 4	
11 027 200	200	175	5 4	
11 027 210	210	190	5 4	
11 027 220	220	200	5 4	
11 027 230	230	205	5 4	
11 027 240	240	213	5 4	
11 027 260	260	230	5 4	

Neu

Wichtiger Sortimentsartikel!





Die Kellenmacher!
 Made in
 Germany

Maurerkellen





Trowel
 Truelle

Wichtiger Sortimentsartikel!



Bayerische Maurerkelle mit S-Hals

Mason's trowel, Bavarian-type, swan's neck
 Truelle de maçon, type Bavière, col de cygne





Art.-Nr.	L/mm	B/mm		EAN
09 030 180	180	225	5 4	
09 030 200	200	255	5 4	
11 030 180	180	225	5 4	
11 030 200	200	255	5 4	

Wichtiger Sortimentsartikel!



Bayerische Maurerkelle mit geradem Hals







Mason's trowel, Bavarian-type, straight neck
 Truelle de maçon, type Bavière, col droit

Art.-Nr.	L/mm	B/mm		EAN
09 031 180	180	225	5 4	
09 031 200	200	255	5 4	
11 031 180	180	225	5 4	
11 031 200	200	255	5 4	

Maurer bzw. Klinkerkelle, Rheinische Form vorne abgerundet

Mason's trowel, Düsseldorf-type
 Truelle de maçon, type Düsseldorf, avec bout rond



Art.-Nr.	L/mm	B/mm		EAN
09 125 180	180	120	5 4	
09 125 200	200	125	5 4	
11 125 180	180	120	5 4	
11 125 200	200	125	5 4	
10 125 180	180	120	5 4	



Maurerkellen

Trowel
Truelle







Die Kellenmacher!
Made in Germany



Maurerkelle, englische Form

Brick trowel, English-type
Truelle de maçon, type Englaise







Art.-Nr.	L/mm	L"/	B/mm		EAN
11 218 006	150	6	75	10 4	
11 218 007	175	7	91	5 4	
11 218 008	200	8	98	5 4	
11 218 010	250	10	118	5 4	
11 218 011	275	11	125	5 4	



Berliner Herzkelle

Plasterer's trowel, Berlin-type
Truelle de plâtrier, façon Berlin

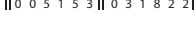

Art.-Nr.	L/mm	B/mm		EAN
09 029 220	220	210	5 4	
09 029 240	240	220	5 4	
09 029 260	260	240	5 4	
11 029 240	240	220	5 4	





Die Kellenmacher!

Made in Germany







Ziegelkellen

Trowel
Truelle









Ziegelkelle, Antwerpen mit S-Hals

Brick trowel, Antwerpen-type, swan's neck
Truelle de maçon, type Anvers, col de cygne

Art.-Nr.	L/mm	B/mm	S/mm		EAN
09 133 180	180	142	1,5	5 4	
11 133 180	180	142	1,5	5 4	
10 133 180	180	142	1,5	 5 4	 

Ziegelkelle, Antwerpen mit geradem Hals







Brick trowel, Antwerpen-type, straight neck
Truelle de maçon, type Anvers, col droit

Art.-Nr.	L/mm	B/mm	S/mm		EAN
09 134 180	180	142	1,5	5 4	
11 134 180	180	142	1,5	5 4	
10 134 180	180	142	1,5	 5 4	 



Ziegelkelle, Aachen

Brick trowel, Aachen-type
Truelle de maçon, type Aix-la-Chapel

Art.-Nr.	L/mm	B/mm	S/mm		EAN
09 131 180	180	140	1,5	5 4	
11 131 180	180	140	1,5	5 4	
10 131 180	180	140	1,5	 5 4	 

Ziegelkellen

Trowel
Truelle





Die Kellenmacher!

Made in
Germany



Ziegelkelle, Brüssel





Brick trowel, Brussels-type
Truelle de maçon, type Bruxelles

Art.-Nr.	L/mm	B/mm	S/mm		EAN
 09 132 180	180	140	1,5	5 4	0 0 5 1 5 3 0 4 4 3 4 1
09 132 190	190	140	1,5	5 4	0 0 5 1 5 3 0 6 6 3 1 2
 11 132 180	180	140	1,5	5 4	0 0 5 1 5 3 0 3 4 8 5 4
 10 132 180	180	140	1,5	 5 4	0 0 5 1 5 3 0 9 3 6 0 8



Ziegelkelle, Paris





Brick trowel, Paris-type
Truelle de maçon, type Paris

Art.-Nr.	L/mm	B/mm	S/mm		EAN
 09 135 180	180	125	1,5	5 4	0 0 5 1 5 3 0 4 4 3 0 3
 11 135 180	180	125	1,5	5 4	0 0 5 1 5 3 0 3 4 8 8 5
 10 135 180	180	125	1,5	 5 4	0 0 5 1 5 3 0 4 4 3 1 0



Ziegelkelle, Charleroi mit S-Hals

Brick trowel, Charleroi-type, with swan's neck
Truelle de maçon, type Charleroi, avec col de cygne

Art.-Nr.	L/mm	B/mm	S/mm		EAN
 09 136 180	180	130	1,5	5 4	0 0 5 1 5 3 0 4 7 7 4 8
09 136 280	180	130	2,0	5 4	0 0 5 1 5 3 0 6 1 3 9 3
09 136 280K	180	130	2,0	5 4	0 0 5 1 5 3 0 6 1 4 0 9
	mit Kantenbruch				
 11 136 180	180	130	1,5	5 4	0 0 5 1 5 3 0 4 6 9 0 1
11 136 280	180	130	2,0	5 4	0 0 5 1 5 3 0 6 1 3 8 6
 10 136 180	180	130	1,5	 5 4	0 0 5 1 5 3 0 4 6 9 1 8





Die Kellenmacher!

Made in
Germany













Ziegelkellen

Trowel
Truelle



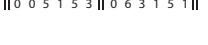









Ziegelkelle, Floreffe

Brick trowel, floreffe-type
Truelle de maçon, type floreffe

Art.-Nr.	L/mm	B/mm	S/mm		EAN
 09 137 180	180	140	1,5	5 4	
 09 137 190	190	140	1,5	5 4	
 09 137 280	180	140	2,0	5 4	
 11 137 180	180	140	1,5	5 4	
 10 137 180	180	140	1,5	 5 4	









Ziegelkelle, Mons

Brick trowel, mons-type
Truelle de maçon, type mons

Art.-Nr.	L/mm	B/mm	S/mm		EAN
 09 138 180	180	135	1,5	5 4	
 09 138 280	180	135	2,0	5 4	
 11 138 180	180	135	1,5	5 4	
 10 138 180	180	135	1,5	 5 4	

Ziegelkelle, Arnheim

für Rechtshänder
Brick trowel for right handers, Dutch-type
Truelle de maçon pour droiter, type Arnheim

Art.-Nr.	L/mm	B/mm	S/mm		EAN
 09 117 180	180	145	1,5	5 4	
 11 117 180	180	145	1,5	5 4	
 10 117 180	180	145	1,5	 5 4	

S* = Blattstärke

Ziegelkellen

Trowel
Truelle

Die Kellenmacher!

Made in
Germany





Ziegelkelle, Arnheim

für Linkshänder

Brick trowel for left handers, Dutch-type

Truelle de maçon pour gaucher, type Arnheim



















Art.-Nr.	L/mm	B/mm	S/mm		EAN
 09 118 180	180	145	1,5	5	4 005153 042392
 11 118 180	180	145	1,5	5	4 005153 044587
 10 118 180	180	145	1,5	 5	4 005153 042385



Walbykelle, amerikanische Form

Brick trowel, walby-type

Truelle de maçon, type walby





Art.-Nr.	L/mm	L"/	B/mm		EAN
 09 219 006	150	6	75	10	4 005153 043436
 09 219 007	175	7	91	5	4 005153 043443
 09 219 008	200	8	98	5	4 005153 043450
 09 219 009	225	9	114	5	4 005153 043467
 09 219 010	250	10	118	5	4 005153 043474
 11 219 005	125	5	60	10	4 005153 031600
 11 219 006	150	6	75	10	4 005153 031617
 11 219 007	175	7	91	5	4 005153 031624
 11 219 008	200	8	98	5	4 005153 031631
 11 219 009	225	9	114	5	4 005153 031648
 11 219 010	250	10	118	5	4 005153 031655
 10 219 005	125	5	60	10	4 005153 031082
 10 219 006	150	6	75	10	4 005153 031099
 10 219 007	175	7	91	 5	4 005153 031105
 10 219 008	200	8	98	5	4 005153 031112
 10 219 009	225	9	114	5	4 005153 031129
 10 219 010	250	10	118	5	4 005153 031136



Forgetresse

Belgian forgetresse

Truelle forgetresse Belge

Art.-Nr.	L/mm	B/mm	S/mm		EAN
 09 235 130	130	30	1,0	10	4 005153 066336
 11 235 130	130	30	1,0	10	4 005153 034809
 10 235 130	130	30	0,8	 10	4 005153 093639



S* = Blattstärke



Die Kellenmacher!

Made in
Germany







Spezialkellen

Special trowels
Truelle



Firstkelle, hinten schräge Schultern









Rooflayer's trowel, inclined shoulders
Truelle de couvreur, épaules coupées

Art.-Nr.	L/mm	B/mm		EAN
 09 206 190	190	73	10 4	 005153061676
 10 206 190	190	73	 10 4	 005153062987

Firstkelle, hinten runde Schulter

Rooflayer's trowel, round shoulders
Truelle de couvreur, épaules ronde









Art.-Nr.	L/mm	B/mm		EAN
 09 205 190	190	73	10 4	 005153043139
 11 205 190	190	73	10 4	 005153031662
 10 205 190	190	73	 10 4	 005153031143

Abbremspachtel, mit langem Griff

Scraper, with extra long handle
Couteau à brûler, avec poignée longue



Art.-Nr.	L/mm	B/mm		EAN
 11 045 080	110	80	10 4	 005153059390
 10 045 080	110	80	 10 4	 005153062932

S* = Blattstärke

Spezialkellen

























Special trowels
Truelle

Die Kellenmacher!
Made in Germany



Berliner Stecherkelle











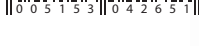

Plasterer's trowel, Berlin-type
Truelle de plâtrier, type Berlin

Art.-Nr.	L/mm	B/mm		EAN
09 100 020	160	20	10 4	
09 100 025	160	25	10 4	
09 100 030	160	30	10 4	
09 100 035	160	35	10 4	
09 100 040	160	40	10 4	
09 100 045	160	45	10 4	
09 100 050	160	50	10 4	
09 100 060	160	60	10 4	
11 100 020	160	20	10 4	
11 100 025	160	25	10 4	
11 100 030	160	30	10 4	
11 100 035	160	35	10 4	
11 100 040	160	40	10 4	
11 100 045	160	45	10 4	
11 100 050	160	50	10 4	
11 100 060	160	60	10 4	
10 100 020	160	20	10 4	
10 100 025	160	25	10 4	
10 100 030	160	30	10 4	
10 100 035	160	35	10 4	
10 100 040	160	40	10 4	
10 100 045	160	45	10 4	
10 100 050	160	50	10 4	
10 100 060	160	60	10 4	



Katzenzunge

Plasterer's trowel, tongue shaped
Truelle langue de chat

Art.-Nr.	L/mm	B/mm		EAN
09 070 120	120	52	10 4	
09 070 140	140	52	10 4	
09 070 160	160	58	10 4	
09 913 031	140	52	10 4	
11 070 120	120	52	10 4	
11 070 140	140	52	10 4	
11 070 160	160	58	10 4	
11 070 180	180	60	10 4	
10 070 120	120	52	10 4	
10 070 140	140	52	10 4	
10 070 160	160	58	10 4	
10 070 180	180	60	10 4	

Neu



Wichtiger Sortimentsartikel!





Die Kellenmacher!

Made in Germany









Putzkellen

Special trowels
Truelle

Zungenkelle

Tongue trowel, Danish-type
Fiche à tuile, type Danois



Art.-Nr.	L/mm	B/mm		EAN
09 090 160	160	45	10 4	 0 05 15 3 0 42 68 2
09 090 170	170	60	10 4	 0 05 15 3 0 42 69 9
11 090 160	160	45	10 4	 0 05 15 3 0 31 41 9
11 090 170	170	60	10 4	 0 05 15 3 0 31 42 6
10 090 160	160	45	10 4	 0 05 15 3 0 30 81 8
10 090 170	170	60	10 4 	 0 05 15 3 0 30 82 5

Berner Putzkelle















Plasterer's trowel, Bern-type
Truelle de plâtrier, type Berne



Wichtiger Sortimentsartikel!

Neu

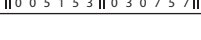

Art.-Nr.	L/mm	B ₁ /mm	B ₂ /mm		EAN
09 060 120	120	55	80	10 4	 0 05 15 3 0 42 88 0
09 060 140	140	60	85	10 4	 0 05 15 3 0 42 89 7
09 060 160	160	65	85	10 4	 0 05 15 3 0 42 90 3
09 913 010	120	55	80	10 4	 0 05 15 3 0 67 65 4
09 913 011	140	60	85	10 4	 0 05 15 3 0 67 66 1
09 913 012	160	65	85	10 4	 0 05 15 3 0 67 67 8
09 913 013	180	75	95	10 4	 0 05 15 3 0 67 68 5
11 060 120	120	55	80	10 4	 0 05 15 3 0 31 33 4
11 060 140	140	60	85	10 4	 0 05 15 3 0 31 34 1
11 060 160	160	65	85	10 4	 0 05 15 3 0 31 35 8
10 060 120	120	55	80	10 4	 0 05 15 3 0 30 73 3
10 060 140	140	60	85 	10 4	 0 05 15 3 0 30 74 0
10 060 160	160	65	85	10 4	 0 05 15 3 0 30 75 7















Berliner Putzkelle

Plasterer's trowel, Berlin-type
Truelle de plâtrier, type Berlin



Neu

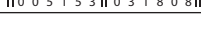

Art.-Nr.	L/mm	B/mm		EAN
09 028 200	200	180	5 4	 0 05 15 3 0 61 57 7
09 028 210	210	185	5 4	 0 05 15 3 0 61 56 0
09 028 220	220	195	5 4	 0 05 15 3 0 42 22 4
09 028 230	230	200	5 4	 0 05 15 3 0 61 55 3
09 028 240	240	210	5 4	 0 05 15 3 0 42 23 1
09 028 260	260	225	5 4	 0 05 15 3 0 42 24 8
09 028 280	280	255	5 4	 0 05 15 3 0 42 25 5
09 905 021	240	210	5 4	 0 05 15 3 0 67 49 4
09 905 022	260	225	5 4	 0 05 15 3 0 67 50 1
09 905 023	280	255	5 4	 0 05 15 3 0 67 51 7
11 028 200	200	180	5 4	 0 05 15 3 0 61 78 2
11 028 210	210	185	5 4	 0 05 15 3 0 63 07 6
11 028 220	220	195	5 4	 0 05 15 3 0 63 08 3
11 028 230	230	200	5 4	 0 05 15 3 0 63 09 0
11 028 240	240	210	5 4	 0 05 15 3 0 31 79 2
11 028 260	260	225	5 4	 0 05 15 3 0 31 80 8

Putzkellen

Special trowels
Truelle





Die Kellenmacher!
Made in Germany



Hamburger Putzkelle

Plasterer's trowel, Hamburg-type
Truelle à polier, type Hambourg



Wichtiger Sortimentsartikel!

Art.-Nr.	L/mm	B/mm		EAN
 09 080 140	140	80	10 4	0 051 533 0 430 009
09 080 160	160	92	10 4	0 051 533 0 430 016
 11 080 140	140	80	10 4	0 051 533 0 313 966
11 080 160	160	92	10 4	0 051 533 0 314 022
 10 080 120	120	75	10 4	0 051 533 0 307 888
10 080 140	140	80	10 4	0 051 533 0 307 955
10 080 160	160	92	10 4	0 051 533 0 308 011



Eiform Putzkelle „HOLSTEIN“





Plasterer's trowel, Holstein type
Truelle de plâtrier, type Holstein

Art.-Nr.	L/mm	B/mm		EAN
 11 224 140	140	63	5 4	0 051 533 0 317 095



Gipserkelle, Süddeutsche Form

Plasterer's trowel, Deggingen-type
Truelle de plâtrier, type Deggingen

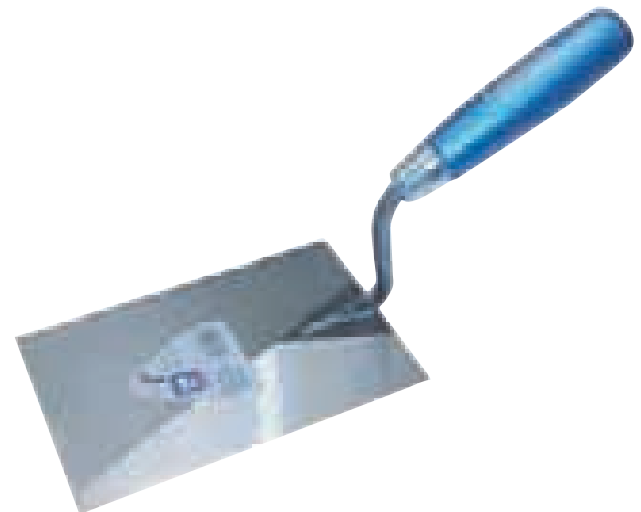

Art.-Nr.	L/mm	B/mm		EAN
 09 025 180	180	120	5 4	0 051 533 0 442 666
09 025 200	200	130	5 4	0 051 533 0 442 733
 11 025 180	180	120	5 4	0 051 533 0 442 997
 10 025 180	180	120	5 4	0 051 533 0 442 800



Stukkateurspachtel, gerade Angel mit Wate

Plasterer's spatula, Suisse-patren
Couteau de plâtrier, type Suisse

Blatt $\begin{array}{c} \downarrow \\ 0,8\text{mm} \\ \uparrow \end{array}$ ← Wate (gefast)

Art.-Nr.	L/mm	B/mm		EAN
 11 010 575	110	75	10 4	0 051 533 0 977 606
 10 010 575	110	75	10 4	0 051 533 0 577 778
10 010 600	120	100	10 4	0 051 533 0 577 855
10 010 650	120	150	10 4	0 051 533 0 510 355

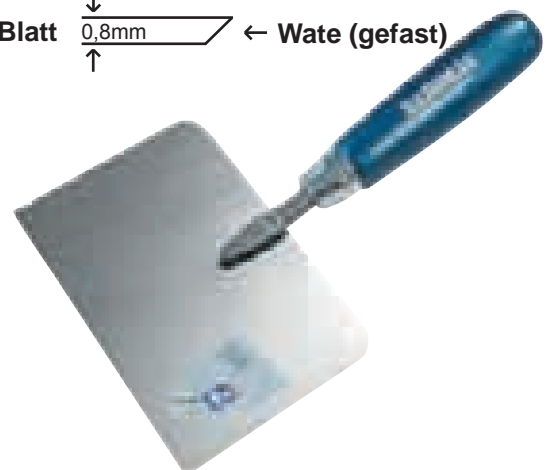



1.14

Stukkateurspachtel

Plasterer's spatula
 Couteau de plâtrier



Wichtiger Sortimentsartikel!

Neu



Art.-Nr.	L/mm	B/mm		EAN
09 010 040	90	40	10 4	0 051 533 042 514 1
09 010 050	95	50	10 4	0 051 533 042 521 1
09 010 060	100	60	10 4	0 051 533 042 538 1
09 010 070	100	70	10 4	0 051 533 042 545 1
09 010 080	110	80	10 4	0 051 533 042 552 1
09 010 100	120	100	10 4	0 051 533 042 569 1
09 010 120	120	120	10 4	0 051 533 042 576 1
09 913 040	90	40	10 4	0 051 533 067 739 1
09 913 041	95	50	10 4	0 051 533 067 746 1
09 913 042	100	60	10 4	0 051 533 067 753 1
09 913 043	100	70	10 4	0 051 533 067 760 1
09 913 044	110	80	10 4	0 051 533 067 777 1
09 913 045	110	90	10 4	0 051 533 067 784 1
09 913 055	120	100	10 4	0 051 533 067 838 1
11 010 040	90	40	10 4	0 051 533 031 204 1
11 010 050	95	50	10 4	0 051 533 031 211 1
11 010 060	100	60	10 4	0 051 533 031 228 1
11 010 070	100	70	10 4	0 051 533 031 235 1
11 010 080	110	80	10 4	0 051 533 031 242 1
11 010 100	120	100	10 4	0 051 533 031 259 1
11 010 120	120	120	10 4	0 051 533 056 924 1
10 010 040	90	40	10 4	0 051 533 030 009 1
10 010 050	95	50	10 4	0 051 533 030 016 1
10 010 060	100	60	10 4	0 051 533 030 023 1
10 010 070	100	70	10 4	0 051 533 030 030 1
10 010 080	110	80	10 4	0 051 533 030 047 1
10 010 100	120	100	10 4	0 051 533 030 054 1
10 010 120	120	120	10 4	0 051 533 030 061 1



Eckenspachtel

Corner spatula
 Spatule à coins



Art.-Nr.	L/mm	B/mm		EAN
10 230 070	100	70	10 4	0 051 533 031 198 1



Fliesenlegerkellen

Trowel
Truelle





Die Kellenmacher!
Made in Germany



Deutsche Fliesenlegerkelle, herzform

Tiler's trowel, heart shaped
Truelle de carreleur en forme de coeur

Wichtiger Sortimentsartikel!





Art.-Nr.	L/mm	B/mm		EAN
 09 040 160	160	110	5	4 005153 043146
 11 040 160	160	110	5	4 005153 031310
 10 040 160	160	110	 5	4 005153 030719



Deutsche Fliesenlegerkelle, herzform

mit Gummikappe





Tiler's trowel, heart shaped, with rubber cup
Truelle de carreleur en forme de coeur, bout en caoutchouc

Art.-Nr.	L/mm	B/mm		EAN
 09 030 160	160	110	5	4 005153 043160
 11 030 160	160	110	5	4 005153 031303
 10 030 160	160	110	 5	4 005153 030702



Süddeutsche Fliesenlegerkelle

Tiler's trowel, south German type
Truelle de carreleur, type Allemagne de sud

Art.-Nr.	L/mm	B/mm		EAN
 09 050 160	160	110	5	4 005153 043177
 11 050 160	160	110	5	4 005153 043184
 10 050 160	160	110	 5	4 005153 030726





Die Kellenmacher!

Made in
Germany









Fliesenlegerkellen

Trowel
Truelle

Süddeutsche Fliesenlegerkelle mit Gummikappe

Tiler's trowel, south German type, with rubber cup
Truelle de carreleur, type Allemagne de sud, bout
en caoutchouc











Art.-Nr.	L/mm	B/mm		EAN
 09 055 160	160	110	5 4	 005153 0628888
 11 055 160	160	110	5 4	 005153 0340388
 10 055 160	160	110	 5 4	 005153 0629499

Hamburger Fliesenlegerkelle

Tiler's trowel, Hamburg type
Truelle de carreleur, facon Hambourg











Art.-Nr.	L/mm	B/mm		EAN
 09 051 160	160	110	5 4	 005153 0441299
 11 051 160	160	110	5 4	 005153 0313227
 10 051 160	160	110	 5 4	 005153 0441366

Hamburger Fliesenlegerkelle mit Gummikappe

Tiler's trowel, Hamburg type, with rubber cup
Truelle de carreleur, facon Hambourg, bout en
caoutchouc



Art.-Nr.	L/mm	B/mm		EAN
 09 056 160	160	110	5 4	 005153 0628955
 11 056 160	160	110	5 4	 005153 0631444
 10 056 160	160	110	 5 4	 005153 0629556

Fliesenlegerkellen

Trowel
Truelle

Die Kellenmacher!

Made in
Germany



Fliesenkleberkellen, gezahnt

Tiler's trowel, toothed
Truelle de carreleur, dentelée



Art.-Nr.	L/mm	B/mm	B _z /mm	Zahn		EAN
10 044 140	140	60	85	li 6x6	10 4	0 0 5 1 5 3 0 6 2 3 4 5
10 044 141	140	60	85	re 6x6	10 4	0 0 5 1 5 3 0 6 2 3 5 2



Fliesenlegerspachtel, gezahnt

Tiler's spatula, toothed
Couteau de carreleur, dentelée



Art.-Nr.	L/mm	B/mm	Zahnung		EAN
10 043 060	95	60	6 x 6	10 4	0 0 5 1 5 3 0 6 2 9 2 5



Stukkateureisen

Plasterer's spattle
Spatule à stuc



Art.-Nr.	L/mm	B/mm		EAN
11 360 006 SB	215	6	10 4	0 0 5 1 5 3 0 5 6 9 4 8
11 360 008 SB	215	8	10 4	0 0 5 1 5 3 0 5 6 9 5 5
11 360 010 SB	215	10	10 4	0 0 5 1 5 3 0 3 2 7 7 5
11 360 012 SB	215	12	10 4	0 0 5 1 5 3 0 5 6 9 7 9
11 360 014 SB	215	14	10 4	0 0 5 1 5 3 0 5 6 9 8 6
11 360 016 SB	215	16	10 4	0 0 5 1 5 3 0 3 2 8 0 5
11 360 018 SB	235	18	10 4	0 0 5 1 5 3 0 5 7 0 0 6
11 360 020 SB	235	20	10 4	0 0 5 1 5 3 0 3 2 8 2 9
11 360 022 SB	235	22	10 4	0 0 5 1 5 3 0 5 7 0 2 0
11 360 024 SB	235	24	10 4	0 0 5 1 5 3 0 5 7 0 3 7
11 360 026 SB	235	26	10 4	0 0 5 1 5 3 0 5 7 0 4 4
11 360 030 SB	235	30	10 4	0 0 5 1 5 3 0 5 7 0 5 1
11 360 035 SB	235	35	10 4	0 0 5 1 5 3 0 5 7 0 6 8
10 360 010	215	10	10 4	0 0 5 1 5 3 0 3 9 1 0 1
10 360 014	215	14	10 4	0 0 5 1 5 3 0 5 6 9 1 7
10 360 016	215	16	10 4	0 0 5 1 5 3 0 3 9 1 3 2
10 360 020	235	20	10 4	0 0 5 1 5 3 0 3 9 1 5 6
10 360 026	235	26	10 4	0 0 5 1 5 3 0 3 9 1 8 7
10 360 030	235	30	10 4	0 0 5 1 5 3 0 3 9 8 0 4



Wichtiger Sortimentsartikel!





Die Kellenmacher!

Made in Germany

Eckenkellen



Trowel
Truelle



Ausseneckenkelle, rund, Radius 8mm

Corner trowel, outside, round
Truelle pour coins extérieurs, ronde



Art.-Nr.	L/mm	B/mm			EAN
10 220 080	80	60	EDELSTAHL Rostfrei	10 4	0 051 533 031167
10 220 090	100	75	EDELSTAHL Rostfrei	10 4	0 051 533 060624
10 220 100	100	100	EDELSTAHL Rostfrei	10 4	0 051 533 031181





Wichtiger Sortimentsartikel!

Ausseneckenkelle, für 90° Ecken

Corner trowel outside, edged
Truelle pour coins extérieurs, pointue



Art.-Nr.	L/mm	B/mm			EAN
10 211 080	80	60	EDELSTAHL Rostfrei	10 4	0 051 533 063021
10 211 090	100	75	EDELSTAHL Rostfrei	10 4	0 051 533 063038
10 211 100	100	100	EDELSTAHL Rostfrei	10 4	0 051 533 063045



Inneneckenkelle, rund, Radius 8mm

Corner trowel, inside, round
Truelle pour coins intérieurs, ronde



Art.-Nr.	L/mm	B/mm			EAN
10 209 080	80	60	EDELSTAHL Rostfrei	10 4	0 051 533 062994
10 209 090	100	75	EDELSTAHL Rostfrei	10 4	0 051 533 063007
10 209 100	100	100	EDELSTAHL Rostfrei	10 4	0 051 533 063014





Wichtiger Sortimentsartikel!

Inneneckenkelle, für 90° Ecken

Corner trowel, inside, edged
Truelle pour coins intérieurs, pointue



Art.-Nr.	L/mm	B/mm			EAN
10 210 080	80	60	EDELSTAHL Rostfrei	10 4	0 051 533 031150
10 210 090	100	75	EDELSTAHL Rostfrei	10 4	0 051 533 060617
10 210 100	100	100	EDELSTAHL Rostfrei	10 4	0 051 533 031174

Fugenkellen

Joint trowel
Réparoir

Die Kellenmacher!
Made in Germany



Hamburger Fugenkelle, Form D lang

flacher Hals

Joint trowel, Hamburg type, flat neck

Réparoir, type Hambourg, col plat

Wichtiger Sortimentsartikel!

Art.-Nr.	L/mm	B/mm	S/mm		EAN
11 330 006	180	6	1,9	10 4	0 0 5 1 5 3 0 3 2 5 8 4
11 330 008	180	8	1,9	10 4	0 0 5 1 5 3 0 3 2 5 9 1
11 330 010	180	10	1,9	10 4	0 0 5 1 5 3 0 3 2 6 1 4
11 330 012	180	12	1,9	10 4	0 0 5 1 5 3 0 3 2 6 2 1
11 330 014	180	14	1,9	10 4	0 0 5 1 5 3 0 3 2 6 3 8
11 330 016	180	16	1,9	10 4	0 0 5 1 5 3 0 3 2 6 4 5
11 330 018	180	18	1,9	10 4	0 0 5 1 5 3 0 3 2 6 5 2
11 330 020	180	20	1,9	10 4	0 0 5 1 5 3 0 3 2 6 6 9
09 916 013	180	12	1,9	10 4	0 0 5 1 5 3 0 8 7 9 8 0
10 330 006	180	6	1,9	10 4	0 0 5 1 5 3 0 6 3 0 5 2
10 330 008	180	8	1,9	10 4	0 0 5 1 5 3 0 4 4 4 6 1 7
10 330 010	180	10	1,9	10 4	0 0 5 1 5 3 0 4 4 4 6 2 4
10 330 012	180	12	1,9	10 4	0 0 5 1 5 3 0 4 4 4 6 3 1
10 330 014	180	14	1,9	10 4	0 0 5 1 5 3 0 4 4 4 6 4 8

Neu



Hohle Fugenkelle

Joint trowel, hollow

Réparoir creux

Art.-Nr.	L/mm	B/mm		EAN
11 361 008	160	8	10 4	0 0 5 1 5 3 0 3 4 5 6 4
11 361 010	160	10	10 4	0 0 5 1 5 3 0 3 4 5 7 1
11 361 012	160	12	10 4	0 0 5 1 5 3 0 6 1 8 9 8
11 361 014	160	14	10 4	0 0 5 1 5 3 0 6 1 9 0 4



Halbrunde Fugenkelle

Joint trowel, half round

Réparoir demi rond

Art.-Nr.	L/mm	B/mm		EAN
11 362 008	160	8	10 4	0 0 5 1 5 3 0 5 1 1 5 8
11 362 010	160	10	10 4	0 0 5 1 5 3 0 5 1 1 6 5
11 362 012	160	12	10 4	0 0 5 1 5 3 0 6 3 2 2 9
11 362 014	160	14	10 4	0 0 5 1 5 3 0 6 3 2 3 6
11 362 030	160	30	10 4	0 0 5 1 5 3 0 3 1 7 3 0



Holländische Fugenkelle, extra stark

Joint trowel, Dutch type, heavy-duty

Réparoir, type Pays-bas, modèle lourd

Neu

Art.-Nr.	L/mm	B/mm	S/mm		EAN
11 332 008	110	8	2,5	10 4	0 0 5 1 5 3 0 6 7 8 7 6
11 332 010	110	10	2,5	10 4	0 0 5 1 5 3 0 6 7 1 9 7
11 332 012	110	12	2,5	10 4	0 0 5 1 5 3 0 6 7 8 6 9





Die Kellenmacher!

Made in
Germany







Spezialkellen

Trowel
Truelle

Holländische Fugenkelle, kurz

Joint trowel, Dutch type, short
Réparoir, type Pays-bas, modèle court











Art.-Nr.	L/mm	B/mm	S/mm		EAN
11 331 006	140	6	1,9	10 4	
11 331 008	140	8	1,9	10 4	
11 331 010	140	10	1,9	10 4	
11 331 012	140	12	1,9	10 4	
11 331 014	140	14	1,9	10 4	
11 331 016	140	16	1,9	10 4	

Dänische Fugenkelle, DIN 6441 D runder Hals

Joint trowel, Danish type, round neck
Réparoir, type Danois, col rond







Art.-Nr.	L/mm	B/mm	S/mm		EAN
11 340 006	180	6	1,9	10 4	
11 340 008	180	8	1,9	10 4	
11 340 010	180	10	1,9	10 4	
11 340 012	180	12	1,9	10 4	
11 340 014	180	14	1,9	10 4	
11 340 016	180	16	1,9	10 4	
11 340 018	180	18	1,9	10 4	
11 340 020	180	20	1,9	10 4	

Putz- und Fugenplatte mit Handgriff

Plasterer's plate
Palette à rejointoiller



feste umlaufende Kanten, zum einfachen Fugen von Klinker und
Fliesen

Art.-Nr.	L/mm	B/mm	Typ		EAN
Kunststoff, Plastic, Plastique					
10 335 120	320	180		1 4	
Rostfrei, Inoxydable, Stainless					
10 335 230	230	145	rechts	1 4	
10 336 230	230	145	links	1 4	







Kellensatz

Berner trowelset
Set de plateau „Berne“

bestehend aus Berner Putzkelle 140, Maurerkelle S-Hals 180,
Glättkelle 280x130x0,7

































Art.-Nr.		EAN
10 000 503	Kellensatz Rostfrei	
		
11 000 503	Kellensatz Stahl	

1.20

Belgische Putzkelle, vorne spitz

Plasterer's trowel, Belgian-type, pointed
Truelle à polir, type Belge, bout pointu































Art.-Nr.	L/mm	B/mm		EAN
 09 221 120	120	74	10 4	
 09 221 140	140	78	10 4	
 09 221 160	160	86	10 4	
 09 221 180	180	90	10 4	
 09 221 200	200	100	10 4	
 11 221 120	120	74	10 4	
 11 221 140	140	78	10 4	
 11 221 160	160	86	10 4	
 11 221 180	180	90	10 4	
 11 221 200	200	100	10 4	
 10 221 120	120	74	10 4	
 10 221 140	140	78	10 4	
 10 221 160	160	86	10 4	
 10 221 180	180	90	10 4	
 10 221 200	200	100	10 4	



1.21

Belgische Putzkelle, vorne rund

Plasterer's trowel, Belgian-type, round blade
Truelle à polir, type Belge, bout rond

Art.-Nr.	L/mm	B/mm		EAN
 09 220 120	120	74	10 4	
 09 220 140	140	78	10 4	
 09 220 160	160	86	10 4	
 09 220 180	180	90	10 4	
 09 220 200	200	100	10 4	
 11 220 120	120	74	10 4	
 11 220 140	140	78	10 4	
 11 220 160	160	86	10 4	
 11 220 180	180	90	10 4	
 11 220 200	200	100	10 4	
 10 220 120	120	74	10 4	
 10 220 140	140	78	10 4	
 10 220 160	160	86	10 4	
 10 220 180	180	90	10 4	
 10 220 200	200	100	10 4	





Die Kellenmacher!

Made in
Germany

Belgische Kellen

Belgian-type
type Belge

Belgische Putzkelle, vorne rund

Plasterer's trowel, Belgian-type







Truelle à polir, type Belge

neutrales Natur-Heft

neutral handle

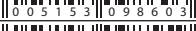
poignée nature



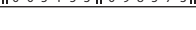



Art.-Nr.	L/mm		EAN
11 433 180	180	4	
11 433 200	200	4	
11 433 220	220	4	
10 433 180	200		4 
10 433 200	280	4	
10 433 220	220	4	

Belgische Ofenkelle

Brick trowel

Truelle de maçon, type haut-fourneau







Art.-Nr.	L/mm	B/mm		EAN
11 219 108	200	98	5 4	
10 219 108	200	98		5 4 

Belgische Fliesenlegerkelle, mit S-Hals

Tiler's trowel, Belgian type, with swan's neck

Truelle de carreleur, type Belge, col de cygne



Art.-Nr.	L/mm	B/mm		EAN
09 052 170	170	120	5 4	
11 052 170	170	120	5 4	
10 052 170	170	120		5 4 

Belgische Kellen





Belgian-type
type Belge

Die Kellenmacher!
Made in
Germany



Belgische Fliesenlegerkelle, mit G-Hals

Tiler's trowel, Belgian type, with straight neck
Truelle de carreleur, type Belge, col droit

Art.-Nr.	L/mm	B/mm		EAN
 09 053 170	170	120	5 4	005153 043207
 11 053 170	170	120	5 4	005153 043214
 10 053 170	170	120	 5 4	005153 043221





Die Kellenmacher!

Made in
Germany











Holländische Kellen

Dutch-type
type Pays-bas

Holl. Pliesterkelle, vorne spitz oder franz. Putzkelle

Plasterer's trowel, Dutch-type, pointed
Truelle de plâtrier, type Pays-bas, bout pointu













Art.-Nr.	L/mm	B/mm		EAN
09 216 120	120	83	10 4	
09 216 140	140	95	10 4	
09 216 160	160	110	10 4	
11 216 120	120	83	10 4	
11 216 140	140	95	10 4	
11 216 160	160	110	10 4	
10 216 120	120	83	10 4	
10 216 140	140	95	10 4	
10 216 160	160	110	10 4	



Holländische Pliesterkelle, vorne rund

Plasterer's trowel, Dutch-type, round blade
Truelle de plâtrier, type Pays-bas, bout rond





Art.-Nr.	L/mm	B/mm		EAN
09 215 120	120	85	10 4	
09 215 140	140	103	10 4	
09 215 160	160	103	10 4	
11 215 120	120	85	10 4	
11 215 140	140	103	10 4	
11 215 160	160	103	10 4	
10 215 120	120	85	10 4	
10 215 140	140	103	10 4	
10 215 160	160	103	10 4	



Holländische Dachkelle

Rooflayer's trowel, Dutch type,
Truelle de couvreur, type Pays-bas



Art.-Nr.	L/mm	B/mm		EAN
11 237 190	190	25	10 4	
10 237 190	190	25	10 4	



1.24

Holländische Kellen

Dutch-type
type Pays-bas







Die Kellenmacher!
Made in Germany



Holländische Fugenkelle, kurz

Joint trowel, Dutch type, short
Réparoir, type Pays-bas, modèle court







Art.-Nr.	L/mm	B/mm	S/mm		EAN
11 331 006	140	6	1,9	10 4	
11 331 008	140	8	1,9	10 4	
11 331 010	140	10	1,9	10 4	
11 331 012	140	12	1,9	10 4	
11 331 014	140	14	1,9	10 4	
11 331 016	140	16	1,9	10 4	



Holländische Fugenkelle, extra stark

Joint trowel, Dutch type, heavy-duty
Réparoir, type Pays-bas, modèle lourd



Art.-Nr.	L/mm	B/mm	S/mm		EAN
11 332 008	110	8	2,5	10 4	
11 332 010	110	10	2,5	10 4	
11 332 012	110	12	2,5	10 4	

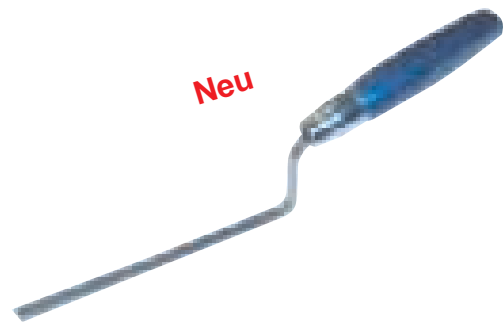



Die Kellenmacher!

Made in
Germany

Dänische Kellen



Danish-type
type Danmark



Dänische Putzkelle

Plasterer's trowel, Danish-type
Truelle de plâtrier, type Danemark



Art.-Nr.	L/mm	B/mm		EAN
11 244 145	145	90	10 4	



10 244 145	145	90	10 4	
------------	-----	----	------	---





1.26



Dänische Stukkateurkelle (Eimerkelle)

Plasterer's trowel, Danish-type
Truelle de plâtrier, type Danemark



Art.-Nr.	L/mm	B/mm		EAN
11 234 170	170	120	5 4	





10 234 170	170	120	5 4	
------------	-----	-----	-----	---



Dänische Spitzkelle, vorne stumpf

Pointed trowel, Danish-type
Truelle de plâtrier, type Danemark



Art.-Nr.	L/mm	B ₁ /mm	B ₂ /mm		EAN
11 233 155	155	80	35	10 4	















10 233 155	155	80	35	10 4	
------------	-----	----	----	------	---





Dänische Dachkelle









Rooflayer' trowel, Danish-type
Truelle de couvreur, type Danemark

Art.-Nr.	L/mm	B/mm		EAN
 09 232 230	195	30	 10 4	
11 232 200	180	30	10 4	
 11 232 225	195	25	10 4	
11 232 230	195	30	10 4	
11 232 235	195	35	10 4	
11 232 240	260	40	10 4	
 10 232 200	180	30	 10 4	



Dänische Fugenkelle, DIN 6441 D

runder Hals
Joint trowel, Danish type, round neck
Réparoir, type Danois, col rond

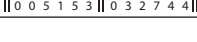
Art.-Nr.	L/mm	B/mm	S/mm	EAN
 11 340 006	180	6	1,9	10 4 
11 340 008	180	8	1,9	10 4 
11 340 010	180	10	1,9	10 4 
11 340 012	180	12	1,9	10 4 
11 340 014	180	14	1,9	10 4 
11 340 016	180	16	1,9	10 4 
11 340 018	180	18	1,9	10 4 
11 340 020	180	20	1,9	10 4 





Die Kellenmacher!

Made in
Germany

Finnische Kellen









Finnish-type
type Finlande



Finnische Putzkelle

Plasterer's trowel, Finnish-type
Truelle de plâtrier, type Finlande

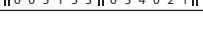

Art.-Nr.	L/mm	L"	B/mm		EAN
11 231 006	150	6	120	5 4	
11 231 007	180	7	130	5 4	
11 231 008	200	8	150	5 4	
11 231 009	230	9	160	5 4	
10 231 006	150	6	120	5 4	
10 231 007	180	7	130	5 4	
10 231 008	200	8	150	5 4	
10 231 009	230	9	160	5 4	



1.28

Schwedische Kellen











Swedish-type
type Suède

Die Kellenmacher!
Made in
Germany



Schwedische Putzkelle

Plasterer's trowel, Swedish-type
Truelle de plâtrier, type Suède

Art.-Nr.	L/mm	B/mm		EAN
 09 185 140	140	70	5 4	
09 185 160	160	75	5 4	
 11 185 140	140	70	5 4	
11 185 160	160	75	5 4	
 10 185 140	140	70	 5 4	
10 185 160	160	75	5 4	





Die Kellenmacher!

Made in
Germany

Norwegische Kellen





Norwegian-type
type Norvège



Norwegische Kelle

Mason's trowel, Norwegian-type
Truelle de maçon, type Norvège

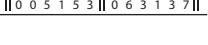

Art.-Nr.	L/mm	B./mm		EAN
11 033 200	200	150	5 4	
11 033 210	210	155	5 4	
11 033 220	220	160	5 4	
11 033 240	240	175	5 4	

Norwegische Putzkelle

Plasterer's trowel, Norwegian-type
Truelle de plâtrier, type Norvège



Art.-Nr.	L/mm	B./mm		EAN
09 180 180	180	110	5 4	
09 180 200	200	120	5 4	
11 180 180	180	110	5 4	
11 180 200	200	120	5 4	
10 180 180	180	110	5 4	
10 180 200	200	120	 5 4	

Griechische Kellen

Greek-type
type grec

Die Kellenmacher!
Made in
Germany













Griechische Kelle, schräge Schulter

Greek trowel, bevelled shoulder, round blade
Truelle de maçon, type grec, bout roud, épaules inclinées

neutrales Natur-Heft

neutral handle

poignée nature

Art.-Nr.	L/mm		EAN
11 430 200	200	10 4	
11 430 220	220	10 4	
11 430 240	240	10 4	
11 430 260	260	10 4	
11 430 280	280	10 4	
10 430 200	200	10 4	
10 430 220	220	10 4	
10 430 240	240	10 4	
10 430 260	260	10 4	
10 430 280	280	10 4	













Griechische Kelle, gerade Schulter

Greek trowel, straight shoulder, round blade
Truelle de maçon, type grec, bout roud, épaules droites

neutrales Natur-Heft

neutral handle

poignée nature

Art.-Nr.	L/mm		EAN
11 431 200	200	10 4	
11 431 220	220	10 4	
11 431 240	240	10 4	
11 431 260	260	10 4	
11 431 280	280	10 4	
10 431 200	200	10 4	
10 431 220	220	10 4	
10 431 240	240	10 4	
10 431 260	260	10 4	
10 431 280	280	10 4	











Griechische Kelle, runde Schulter

Greek trowel, round shoulder, round blade
Truelle de maçon, type grec, bout roud, épaules rondes

neutrales Natur-Heft

neutral handle

poignée nature

Art.-Nr.	L/mm		EAN
11 432 200	200	10 4	
11 432 220	220	10 4	
11 432 240	240	10 4	
11 432 260	260	10 4	
11 432 280	280	10 4	
10 432 200	200	10 4	
10 432 220	220	10 4	
10 432 240	240	10 4	
10 432 260	260	10 4	
10 432 280	280	10 4	





Die Kellenmacher!
Made in
Germany

Irische Kellen





Irish-type
type Irlande



Irische Putzkelle

Plasterer's trowel, Irish type
Truelle de plâtrier, type Irlande



Art.-Nr.	L/mm	L"/	B/mm		EAN
11 236 150	150	6	85	5 4	
11 236 200	200	8	100	5 4	
11 236 250	250	10	120	5 4	

Italienische Kellen

Italian-type
type Italienne

Die Kellenmacher!
Made in Germany



Italienische Kelle, vorne kantig

Mason's trowel, Italian-type, square blade
Truelle de maçon, type Italienne, bout carré

Art.-Nr.	L/mm	B1/mm	B2/mm		EAN
09 012 180	180	85	105	5 4	0 0 5 1 5 3 0 4 4 1 4 3
09 012 200	200	85	120	5 4	0 0 5 1 5 3 0 4 4 1 5 0
09 012 220	220	85	130	5 4	0 0 5 1 5 3 0 4 4 1 6 7
09 012 240	240	85	135	5 4	0 0 5 1 5 3 0 6 2 8 7 1
11 012 180	180	85	105	5 4	0 0 5 1 5 3 0 3 1 4 4 0
11 012 200	200	85	120	5 4	0 0 5 1 5 3 0 3 1 4 6 4
11 012 220	220	85	130	5 4	0 0 5 1 5 3 0 3 1 4 8 8
11 012 240	240	85	135	5 4	0 0 5 1 5 3 0 5 0 6 0 1
10 012 180	180	85	105	5 4	0 0 5 1 5 3 0 3 0 9 2 4
10 012 200	200	85	120	5 4	0 0 5 1 5 3 0 3 0 9 4 8
10 012 220	220	85	130	5 4	0 0 5 1 5 3 0 3 0 9 6 2



Italienische Kelle, vorne abgerundet

Mason's trowel, Italian-type, round blade
Truelle de maçon, type Italienne, bout rond

Art.-Nr.	L/mm	B1/mm	B2/mm		EAN
09 011 180	180	50	120	5 4	0 0 5 1 5 3 0 4 4 2 0 4
09 011 200	200	50	125	5 4	0 0 5 1 5 3 0 4 4 2 1 1
09 011 220	220	50	135	5 4	0 0 5 1 5 3 0 4 4 2 2 8
09 011 240	240	50	140	5 4	0 0 5 1 5 3 0 6 2 6 1 1
11 011 180	180	50	120	5 4	0 0 5 1 5 3 0 3 1 4 3 3
11 011 200	200	50	125	5 4	0 0 5 1 5 3 0 3 1 4 5 7
11 011 220	220	50	135	5 4	0 0 5 1 5 3 0 3 1 4 7 1
11 011 240	240	50	140	5 4	0 0 5 1 5 3 0 5 0 6 1 8
10 011 180	180	50	120	5 4	0 0 5 1 5 3 0 3 0 9 1 7
10 011 200	200	50	125	5 4	0 0 5 1 5 3 0 3 0 9 3 1
10 011 220	220	50	135	5 4	0 0 5 1 5 3 0 3 0 9 5 5



Italienische Kelle, halb-breit vorne abgerundet

Mason's trowel, Italian-type, smal model, round blade
Truelle de maçon, type Italienne, bout rond

Art.-Nr.	L/mm	B ₁ /mm	B ₂ /mm		EAN
09 036 120	120	32	64	5 4	0 0 5 1 5 3 0 9 3 5 4 7
09 036 140	140	32	70	5 4	0 0 5 1 5 3 0 9 3 5 5 4
09 036 160	160	32	75	5 4	0 0 5 1 5 3 0 9 3 5 6 1
09 036 180	180	45	95	5 4	0 0 5 1 5 3 0 9 3 5 7 8
11 036 120	120	32	64	5 4	0 0 5 1 5 3 0 3 6 4 0 7
11 036 140	140	32	70	5 4	0 0 5 1 5 3 0 3 6 4 1 4
11 036 160	160	32	75	5 4	0 0 5 1 5 3 0 3 6 4 2 1
11 036 180	180	45	95	5 4	0 0 5 1 5 3 0 8 1 7 2 8
10 036 120	120	32	64	5 4	0 0 5 1 5 3 0 6 2 9 0 1
10 036 140	140	32	70	5 4	0 0 5 1 5 3 0 6 1 4 7 8
10 036 160	160	32	75	5 4	0 0 5 1 5 3 0 6 1 4 8 5
10 036 180	180	45	95	5 4	0 0 5 1 5 3 0 6 2 9 1 8



S* = Blattstärke



Die Kellenmacher!

Made in
Germany

Portugiesische Kellen









Portugies-type
type Portugese

Portugiesische Maurerkelle, vorne rund schräge Schultern

Maison's trowel, Portugies type, round blade, inclined
shoulders

Truelle de maçon, type Portugese, bout rond, épaules
inclinées





Art.-Nr.	L/mm	B ₁ /mm	B ₂ /mm		EAN
11 401 180	180	45	118	10 4	
11 401 200	200	45	120	10 4	
11 401 220	220	45	122	10 4	
11 401 240	240	45	134	10 4	
10 401 180	180	45	118	10 4	
10 401 200	200	45	120	10 4	
10 401 220	220	45	122	10 4	
10 401 240	240	45	134	10 4	

Portugiesische Maurerkelle, vorne spitz

Maison's trowel, Portugies type, pointed

Truelle de maçon, type Portugese, bout pointu











Art.-Nr.	L/mm	B ₁ /mm	B ₂ /mm		EAN
11 402 240	240	10	110	10 4	
10 402 240	240	10	110	10 4	

Portugiesische Maurerkelle, vorne rund gerade Schultern

Maison's trowel, Portugies type, round blade

Truelle de maçon, type Portugese, bout rond



Art.-Nr.	L/mm	B ₁ /mm	B ₂ /mm		EAN
11 400 180	180	50	114	10 4	
11 400 200	200	54	118	10 4	
11 400 220	220	55	120	10 4	
11 400 240	240	58	125	10 4	
10 400 180	180	50	114	10 4	
10 400 200	200	54	118	10 4	
10 400 220	220	55	120	10 4	
10 400 240	240	58	125	10 4	

Portugiesische Kellen

Portugies-type
type Portugese







Die Kellenmacher!

Made in
Germany



Portugiesische Putzkelle, vorne spitz







Plasterer's trowel, Portugies type, pointed
Truelle de plâtrier, type Portugese, bout pointu

Art.-Nr.	L/mm	B/mm		EAN
 15 403 125	125	70	10 4	 0 051 531 058 393
 10 403 125	125	70	 10 4	 0 051 531 058 409



Portugiesische Putzkelle, vorne rund

Plasterer's trowel, Portugies type, round blade
Truelle de plâtrier, type Portugese, bout ronde

Art.-Nr.	L/mm	B/mm		EAN
 15 404 125	125	70	10 4	 0 051 531 058 416
 10 404 125	125	70	 10 4	 0 051 531 058 423



Die Kellenmacher!

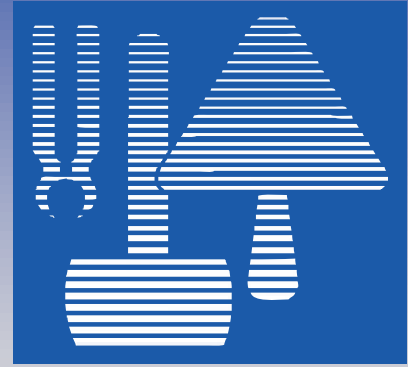

HAROMAC[®]
WERKZEUGFABRIK

GLÄTTE-
KELLEN
PLASTERING
TROWELS
PLATOIRS

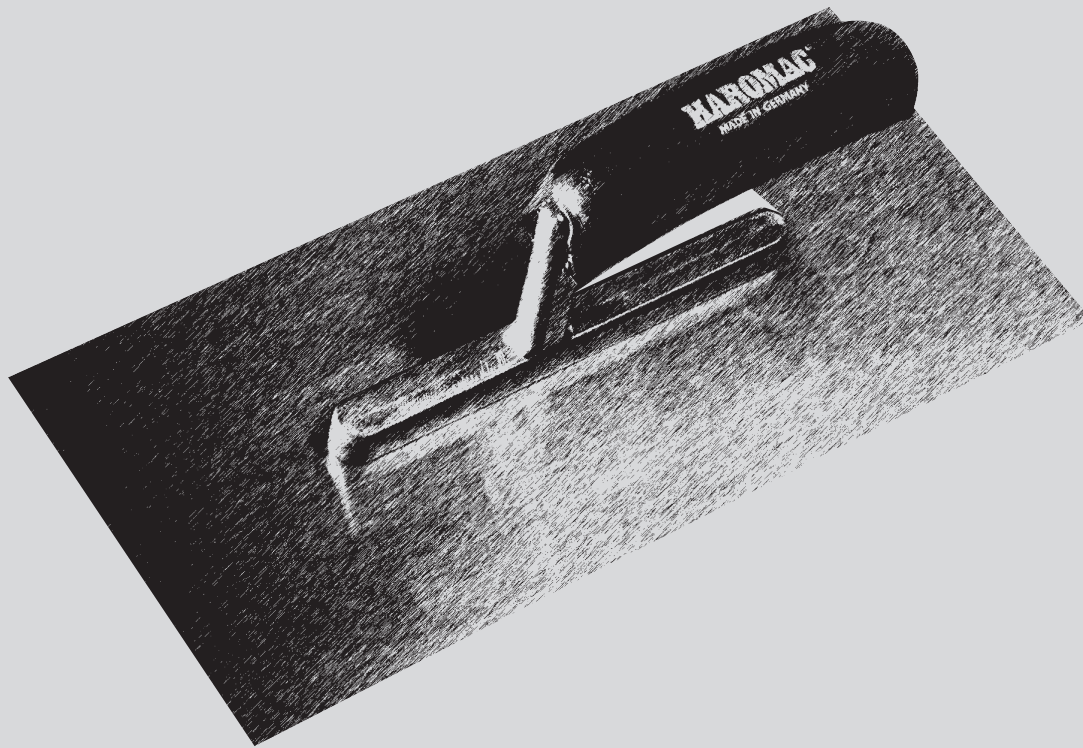

GLÄTTEKELLEN

PLASTERING TROWELS
PLATOIRS

Glättekellen

Plastering trowel
Platoir

Die Kellenmacher!

Made in
Germany



Glättekelle

Plastering trowel
Platoir

mit geschweiftem Holzgriff, **extra starkes Blatt**
with curved wooden handle, **strong blade**
avec poignée courbée en bois, **lame tres fort**

Art.-Nr.	L mm	B mm	S mm		
10 505 240	240	130	1,0	10 4	0 0 5 1 5 3 0 6 7 9 1 3
10 505 280	280	230	1,0	10 4	0 0 5 1 5 3 0 6 2 6 2 8

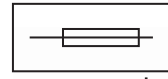

Blatt
1 mm



Glättekelle

Plastering trowel
Platoir

mit geschweiftem Holzgriff
with curved wooden handle
avec poignée courbée en bois

Art.-Nr.	L mm	B mm	S mm		
09 510 280	280	130	0,7	10 4	0 0 5 1 5 3 0 4 4 5 3 2
09 931 010	280	130	0,7	10 4	0 0 5 1 5 3 0 8 8 0 0 0
11 510 270	270	130	0,7	10 4	0 0 5 1 5 3 0 5 7 1 2 9
11 510 280	280	130	0,7	10 4	0 0 5 1 5 3 0 3 1 9 3 8
11 510 400	400	130	0,7	10 4	0 0 5 1 5 3 0 5 1 2 2 6
10 510 280	280	130	0,7	10 4	0 0 5 1 5 3 0 4 4 5 4 9
10 510 400	400	130	0,7	10 4	0 0 5 1 5 3 0 6 2 6 0 4



Wichtiger Sortimentsartikel!

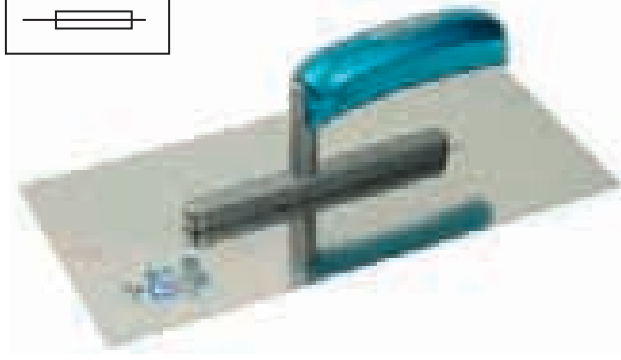

Neu

runder Holzgriff

cylindrical wooden handle,
poignée cylindrique en bois

15 510 280	280	130	0,7	10 4	0 0 5 1 5 3 0 3 1 8 6 0
------------	-----	-----	-----	------	---------------------------

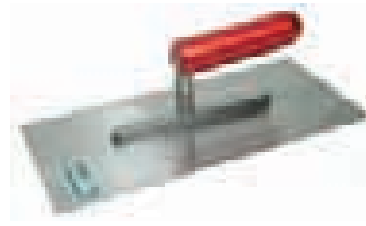

Glättekelle mit Soft-Griff

Plastering trowel with soft-feel
Platoir avec poignée en caoutchouc

starker & leichter Aluminium Stütze
cushioned handle, strong & lightweight die cast aluminium shank
forte & légère monture en aluminium

Art.-Nr.	L mm	B mm	S mm		
11 511 280	280	130	0,7	10 4	0 0 5 1 5 3 0 5 1 5 9 2
10 511 280	280	130	0,7	10 4	0 0 5 1 5 3 0 5 1 5 9 9

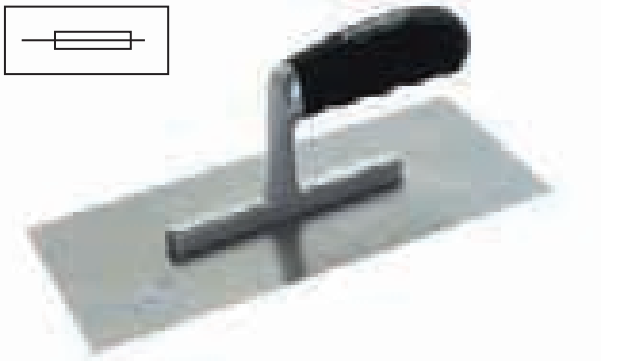
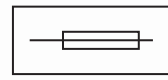

(D) L = Länge
 B = Breite
 S = Blattstärke
 (GB) L = Length
 B = Width
 S = Thickness of the blade
 (F) L = Longueur
 B = Largeur
 S = Grosseur du lame



Die Kellenmacher!

Made in Germany

Glättekellen

Plastering trowel
Platoir

Glättekelle, mit 8 Bolzen - Extra stabile Stütze („Superkelle“)

Plastering trowel
Platoir, avec poignée en bois

und extra starker Alu-Stütze, 8-fach vernietet, extrem lange Haltbarkeit, höchste Quadratmeterleistung

curved wooden handle, strong & lightweight die cast aluminium shank, double riveted

forte & légère monture en aluminium

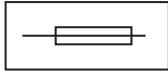

Art.-Nr.	L mm	B mm	S mm	
09 521 280	280	130	0,7	10 4
10 521 280	280	130	0,7	10 4

Kunststoff Glättekelle

Plastic plastering trowel
Platoir plastique

Blatt ABS mit Kunststoffgriffstütze

blade ABS with plastic shank and handle

lame en ABS, monture et poignée en plastique

Wichtiger Sortimentsartikel!

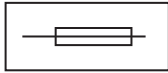

Art.-Nr.	L mm	B mm	S mm	
16 010 280	280	140	2	10 4
16 015 280	280	140	3	10 4
mit Spitze, bout pointé, pointu:				
16 016 280	280	140	Spitz	3 10 4
gezahnt, notched, dentelée:				
16 017 280	280	140	gezahnt	3 10 4

Gezahnte Glättekelle mit 1K-Soft-Griff

Notched plastering trowel
Platoir, dentelée

starker & leichter Alu-Stütze

with soft-feel cushioned handle, strong & lightweight die cast aluminium shank

avec poignée en caoutchouc, forte & légère monture en aluminium

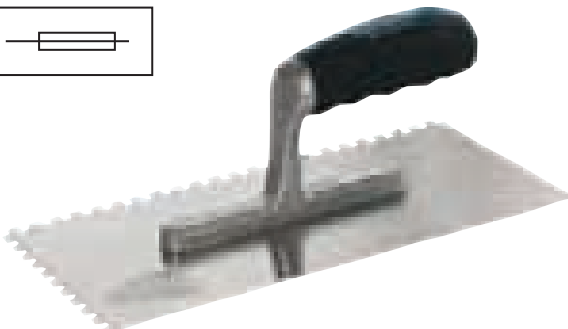
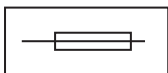

Art.-Nr.	L mm	B mm	Zahn	S mm	
11 518 004	280	130	4x 4	0,7	10 4
11 518 006	280	130	6x 6	0,7	10 4
11 518 008	280	130	8x 8	0,7	10 4
11 518 010	280	130	10x10	0,7	10 4
11 518 020	280	130	halbrund	0,7	10 4
10 518 004	280	130	4x 4	0,7	10 4
10 518 006	280	130	6x 6	0,7	10 4
10 518 008	280	130	8x 8	0,7	10 4
10 518 010	280	130	10x10	0,7	10 4
10 518 020	280	130	halbrund	0,7	10 4

Ⓓ L = Länge
B = Breite
S = Blattstärke

ⒼⒷ L = Length
B = Width
S = Thickness of the blade

Ⓕ L = Longueur
B = Largeur
S = Grosseur du lame

Glättzellen

Plastering trowel
Platoir

Die Kellenmacher!

Made in
Germany



Venezianer Glättkelle mit Soft-Griff

Plastering trowel
Platoir, type venitienne

starke & leichte Aluminium Stütze, gefaste und polierte Kanten, für Marmorputz und hohe Anpressdrücke

Venezian-type, with soft-feel cushioned handle, strong & lightweight die cast aluminium shank

avec poignée en caoutchouc, fort & léger monture en aluminium

Wichtiger Sortimentsartikel!

Art.-Nr.	L mm	B ₁ mm	B ₂ mm	S mm		Barcode
10 519 200	200	90	80	0,7	10 4	0 0 5 1 5 3 0 5 7 7 3 0
10 519 240	240	100	80	0,7	10 4	0 0 5 1 5 3 0 5 3 2 0 6
10 519 280	280	120	100	0,7	10 4	0 0 5 1 5 3 0 5 3 2 1 3

mit Holzheft / with wooden handle:

10 519 201	200	90	80	0,7	10 4	0 0 5 1 5 3 1 0 3 1 4 7
10 519 241	240	100	80	0,7	10 4	0 0 5 1 5 3 1 0 3 1 5 4
10 519 281	280	120	100	0,7	10 4	0 0 5 1 5 3 1 0 3 1 6 1

rechteckig mit Holzheft / square with wooden handle

10 519 205	200	90		0,7	10 4	0 0 5 1 5 3 1 0 3 1 7 8
10 519 245	240	100		0,7	10 4	0 0 5 1 5 3 1 0 3 1 8 5
10 519 285	280	120		0,7	10 4	0 0 5 1 5 3 1 0 3 1 9 2

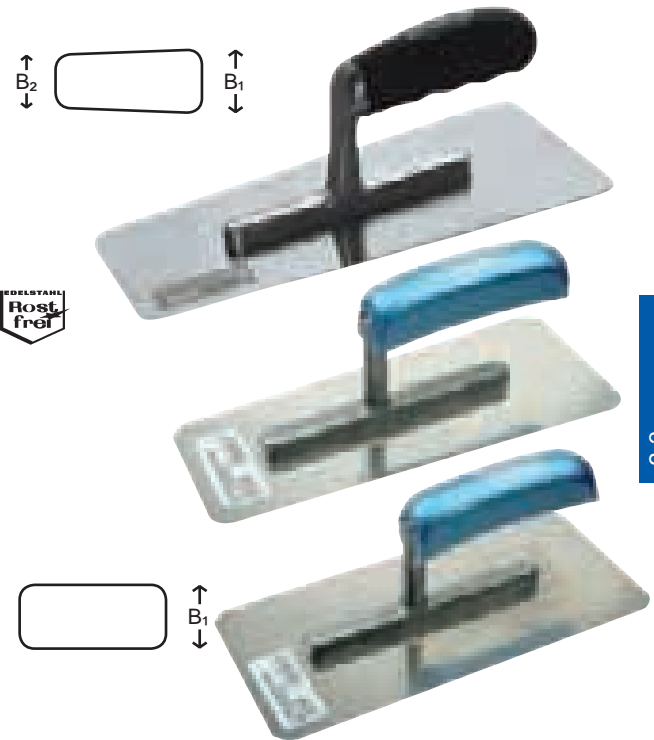

Diston-Glättkelle

American plastering trowel
Platoir avec poignée en bois

mit Holzgriff und extra langer Alu-Stütze

curved wooden handle, long & lightweight die cast aluminium shank

longue & léger monture en aluminium

Art.-Nr.	L mm	B mm	S mm		Barcode
09 520 280	280	120	0,7	10 4	0 0 5 1 5 3 0 4 4 5 0 1
10 520 280	280	120	0,7	10 4	0 0 5 1 5 3 0 3 2 0 2 7



Glättkelle, 4 Seiten gefast

Swiss plastering trowel
Platoir, type Suisse

mit Wate und geschweiftem Holzgriff

chamfered, with curved wooden handle

biseauté avec poignée courbée en bois

Art.-Nr.	L mm	B mm	S mm		Barcode
11 514 280	280	130	0,7	10 4	0 0 5 1 5 3 0 6 2 1 0 9
10 514 280	280	130	0,7	10 4	0 0 5 1 5 3 0 6 6 2 7 5

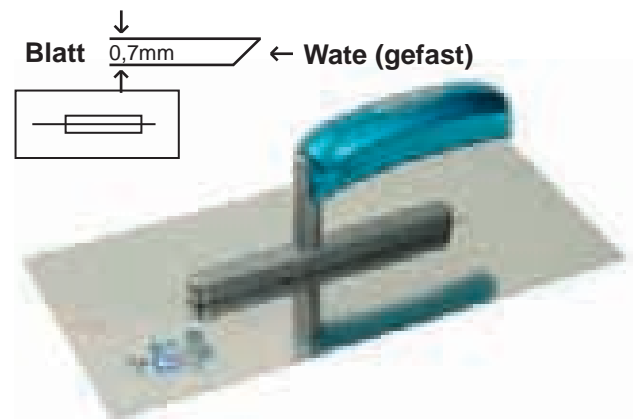

(D) L = Länge
 B = Breite
 S = Blattstärke
 (GB) L = Length
 B = Width
 S = Thickness of the blade
 (F) L = Longueur
 B = Largeur
 S = Grosseur du lame



Die Kellenmacher!

Made in Germany

Glättekellen

Plastering trowel
Platoir

Wichtiger Sortimentsartikel!



Gezahnte Glättekelle

Notched plastering trowel
Platoir, dentelée

mit geschweiftem Holzgriff

with curved handle

avec poignée courbée en bois

Art.-Nr.	L mm	B mm	Zahn	S mm	
09 515 004	280	130	4x 4	0,7	10 4
09 515 006	280	130	6x 6	0,7	10 4
09 515 008	280	130	8x 8	0,7	10 4
09 515 010	280	130	10x10	0,7	10 4
09 515 020	280	130	halbrund	0,7	10 4
11 515 004	280	130	4x 4	0,7	10 4
11 515 006	280	130	6x 6	0,7	10 4
11 515 008	280	130	8x 8	0,7	10 4
11 515 010	280	130	10x10	0,7	10 4
11 515 020	280	130	halbrund	0,7	10 4
10 515 004	280	130	4x 4	0,7	10 4
10 515 006	280	130	6x 6	0,7	10 4
10 515 008	280	130	8x 8	0,7	10 4
10 515 010	280	130	10x10	0,7	10 4
10 515 020	280	130	halbrund	0,7	10 4

runder Holzgriff, cylindrical wooden handle, poignée
cylindrique en bois

15 515 004	280	130	4x 4	0,7	10 4
15 515 006	280	130	6x 6	0,7	10 4
15 515 008	280	130	8x 8	0,7	10 4
15 515 010	280	130	10x10	0,7	10 4
15 515 020	280	130	halbrund	0,7	10 4

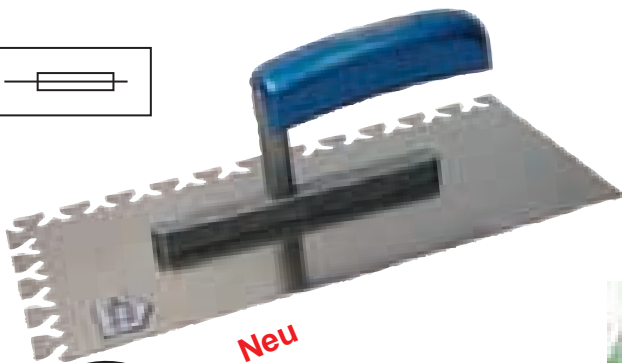
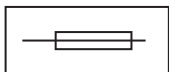
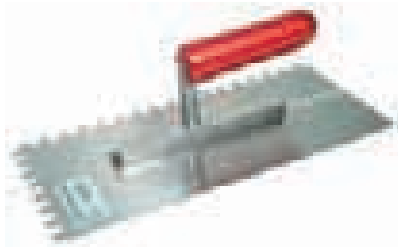

Neu



Speziell für Tiefbettverlegung von Fliesen und Platten im Aussenbereich.

Glättekelle Papillon

rostfrei, Sonderzahnung

Plastering trowel

Platoir

rostfrei, Sonderzahnung, Klebverteilkele, erzeugt ein 5mm hohes Kleber/Mörtelbett ohne Luftpinschlüsse.

Art.-Nr.	L mm	B mm	S mm	
10 515 050	280	130	0,7	10 4
10 518 050	280	130	0,7	10 4

schwarzer Softgriff

Ⓓ L = Länge
B = Breite
S = Blattstärke

ⒼⒷ L = Length
B = Width
S = Thickness of the blade

Ⓕ L = Longueur
B = Largeur
S = Grosseur du lame

Glättzellen

Plastering trowel
Platoir

Die Kellenmacher!

Made in
Germany



Glättkelle mit allseitiger Zahnung

Plastering trowel
Platoir

Art.-Nr.	L mm	B mm	S mm	
11 515 500	280	130	spitz 0,7 10 4	

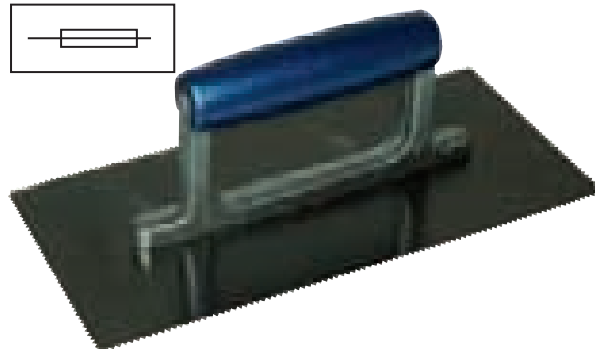
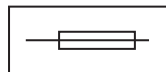

Kleberverteilkelle mit auswechselbarer Zahnleiste

Plastering trowel
Platoir à lames

zum Einschieben auswechselbare Zahnleiste
with wooden handle, for replaceable blades with 7 notch designs
dentelées interchangeables avec poignée en bois

Art.-Nr.	L mm	B mm	Zahn	S mm	
11 530 280	280	100		0,7 10 4	

Lose Zahnleisten, notched comb, peignes dentelés

11 531 001	A3	280	spitz	10 4	
11 531 003	C3	280	3x 3	10 4	
11 531 004	C1	280	4x 4	10 4	
11 531 006	C2	280	6x 6	10 4	
11 531 008	C4	280	8x 8	10 4	
11 531 010	C5	280	10x10	10 4	
11 531 014		280	12x 7x 9	10 4	

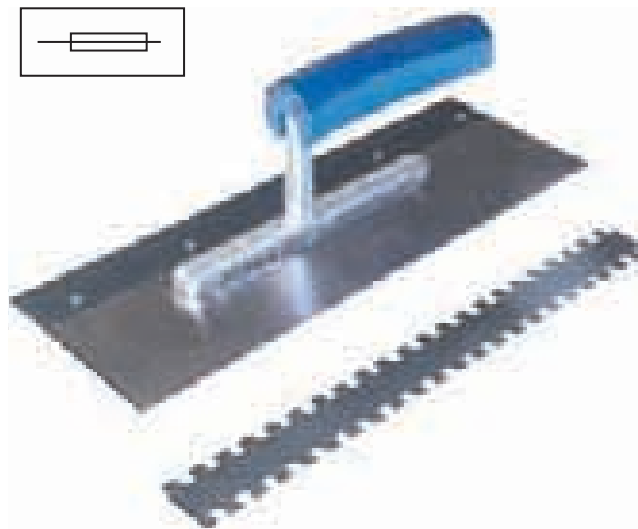
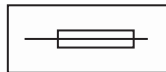

Kellensatz „Floorbest“

Floorbest trowelset

Set de platoir „Floorbest“

satzweise verpackt, bestehend aus 3 gezahnten Blättern, 1 ungezahntes Blatt, 1 Griff und Schrauben

packed per set with 3 blades notched, 1 blade (no notches), 1 handle and screws

emballé par kit avec 3 lames dentelées, 1 lame (sans dents), 1 poignée et jeu de vis

Art.-Nr.	L mm	B mm	Zahn	S mm	
----------	---------	---------	------	---------	--

Set 5 tlg., pcs. (andere Zusammenstellungen möglich)

11 540 005	280	130		0,7 10 4	
------------	-----	-----	--	----------	--

Griff komplett mit Schrauben,

Handle complete with screws,

Poignée complète avec jeu de vis

11 541 001	200			10 4	
------------	-----	--	--	------	--



Lose Blätter,

replaceable blades,

lames de rechange

11 541 000		280	130	glatt	0,7 10 4	
11 541 004	C1	280	130	4x 4	0,7 10 4	
11 541 006	C2	280	130	6x 6	0,7 10 4	
11 541 008	C4	280	130	8x 8	0,7 10 4	
11 541 010	C5	280	130	10x10	0,7 10 4	
11 541 020		280	130	halbrund	0,7 10 4	

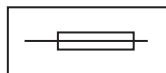

(D) L = Länge
 B = Breite
 S = Blattstärke
 (GB) L = Length
 B = Width
 S = Thickness of the blade
 (F) L = Longueur
 B = Largeur
 S = Grosseur du lame



Die Kellenmacher!

Made in Germany



Glättekellen

Plastering trowel
Platoir



Aufziehplatten, mit Doppelgriff, „Extra Groß“

Swiss plastering trowel, large with double handle
Taloche large, avec double poignée en bois

Art.-Nr.	L mm	B mm	S mm	
11 580 450	450	270	1,2	10 ₄ 
11 580 500	500	270	1,2	10 ₄ 

(weitere Abmessungen auf Anfrage)



Bodenlegerkelle, vorne spitz









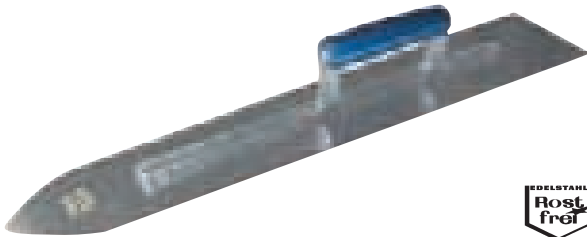

Flooring trowel
Platoir type Flamand

runder Holzgriff, geschlossen

pointed, round wooden closed handle

avec poignée en bois ronde, bout pointu



Art.-Nr.	L mm	B ₁ mm	B ₂ mm	S mm	
11 560 400	400	110	80	1,2	10 ₄ 
11 560 450	450	110	80	1,2	10 ₄ 
11 560 500	500	110	80	1,2	10 ₄ 
11 560 600	600	110	80	1,2	10 ₄ 
11 560 700	700	110	80	1,2	10 ₄ 
11 560 800	800	110	80	1,2	10 ₄ 
10 560 450	450	110	80	0,7	10 ₄ 
10 560 500	500	110	80	0,7	10 ₄ 
10 560 600	600	110	80	0,7	10 ₄ 



Bodenlegerkelle, vorne spitz, schmal

Flooring trowel
Platoir type Flamand







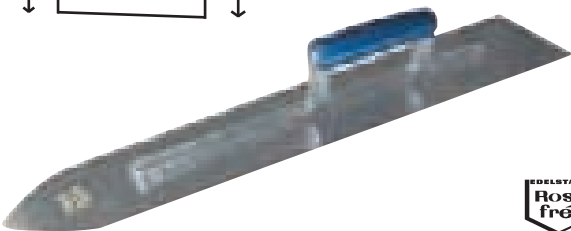

mit balligem Holzgriff, geschlossen

pointed, with ball-shaped wooden handle, closed

bout pointu, avec poignée en bois bombée

Wichtiger Sortimentsartikel!

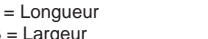

Art.-Nr.	L mm	B ₁ mm	B ₂ mm	S mm	
11 561 450	450	90	70	1,2	10 ₄ 
11 561 500	500	90	70	1,2	10 ₄ 
11 561 600	600	90	70	1,2	10 ₄ 
11 561 700	700	90	70	1,2	10 ₄ 
11 561 800	800	90	70	1,2	10 ₄ 
10 561 450	450	90	70	0,7	10 ₄ 
10 561 500	500	90	70	0,7	10 ₄ 
10 561 600	600	90	70	0,7	10 ₄ 



(D) L = Länge
 B = Breite
 S = Blattstärke
 (GB) L = Length
 B = Width
 S = Thickness of the blade
 (F) L = Longueur
 B = Largeur
 S = Grosseur du lame

Schweizer Glättkellen

Plastering trowels, Swiss-type
Platoir étroite, type Suisse

Die Kellenmacher!











Made in
Germany



Schweizer Glättkelle mit Holzgriff

Swiss plastering trowel with wooden handle
Taloche, type Suisse avec poignée en bois

Wichtiger Sortimentsartikel!

Art.-Nr.	L mm	B mm	S mm			
 11 550 480	480	130	0,7	10	4	
11 550 500	500	130	0,7	10	4	
11 555 500	500	140	0,8	10	4	
 10 550 480	480	130	0,7	10	4	
10 550 500	500	130	0,7	10	4	
10 552 480	480	180	1,0	10	4	
10 555 500	500	140	0,8	10	4	





(normale Kanten)



Schweizer Aufziehglätter , 4 Seiten gefast

Swiss plastering trowel
Taloche type Suisse

schwere Ausführung, 4 Seiten gefast
strong blade, 4 sides chamfered
lame forte, 4 côtés biseauté

Art.-Nr.	L mm	B mm		S mm			
 11 556 500	500	140	Wate	0,8	10	4	
 10 556 500	500	140	Wate	0,8	10	4	









Blatt $\frac{0,8\text{mm}}$ ← Wate (gefast)



Schweizer Glättkelle mit Aluminiumsteg, „Extra Stark“

Swiss plastering trowel
Taloche, type Suisse

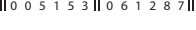
mit Alu-Steg und Holzgriff, für hohe m²-Leistungen
aluminium mounting and wooden handle
avec monture en aluminium et poignée en bois

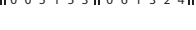
Art.-Nr.	L mm	B mm	S mm			
 09 550 500	500	130	0,7	10	4	
 09 932 074	500	130	0,7	10	4	
 09 553 500	500	140	0,8	10	4	
 10 549 500	500	130	0,7	10	4	
10 553 500	500	140	0,8	10	4	

Neu



(D) L = Länge
 B = Breite
 S = Blattstärke
 (GB) L = Length
 B = Width
 S = Thickness of the blade
 (F) L = Longueur
 B = Largeur
 S = Grosseur du lame



Die Kellenmacher!

Made in Germany

Schweizer Glättkellen

Plastering trowels, Swiss-type
Platoir étroite, type Suisse

Blatt $\frac{0,8mm}{\uparrow \downarrow}$ ← Wate (gefast)



Schweizer Aufziehglätter mit Aluminiumsteg, „Extra Stark“, 4 Seiten gefast

Swiss plastering trowel
Taloche type Suisse

schwere Ausführung mit Aluleiste, 4 Seiten gefast
strong blade, aluminium support, 4 sides chamfered
lame forte avec support aluminium, 4 côtés biseauté



Art.-Nr.	$\frac{L}{mm}$	$\frac{B}{mm}$	Wate	$\frac{S}{mm}$		Barcode
09 554 500	500	140	Wate	0,8	10 4	0 0 5 1 5 3 0 6 1 2 9 4
10 554 500	500	140	Wate	0,8	10 4	0 0 5 1 5 3 0 6 1 3 3 1

Schweizer Glättkelle mit Aluminiumsteg, „Extra Stark“

Notched Swiss plastering trowel
Taloche, type Suisse

mit Alu-Steg und Holzgriff, für hohe m²-Leistung
aluminium mounting and wooden handle
avec monture en aluminium et poignée en bois, dentelée



Art.-Nr.	$\frac{L}{mm}$	$\frac{B}{mm}$	Zahn	$\frac{S}{mm}$		Barcode
09 551 004	480	130	4x 4	0,7	10 4	0 0 5 1 5 3 0 4 4 0 8 2
09 551 006	480	130	6x 6	0,7	10 4	0 0 5 1 5 3 0 4 4 0 9 9
09 551 008	480	130	8x 8	0,7	10 4	0 0 5 1 5 3 0 4 4 1 0 5
09 551 010	480	130	10x10	0,7	10 4	0 0 5 1 5 3 0 4 4 1 1 2

Schweizer Glättkelle, gezahnt mit Holzgriff

Notched Swiss plastering trowel with wooden handle
Taloche, type Suisse avec poignée en bois, dentelée



Art.-Nr.	$\frac{L}{mm}$	$\frac{B}{mm}$	Zahn	$\frac{S}{mm}$		Barcode
11 551 004	500	130	4x 4	0,7	10 4	0 0 5 1 5 3 0 3 2 9 9 7
11 551 006	500	130	6x 6	0,7	10 4	0 0 5 1 5 3 0 3 3 0 0 0
11 551 008	500	130	8x 8	0,7	10 4	0 0 5 1 5 3 0 3 3 0 1 7
11 551 010	500	130	10x10	0,7	10 4	0 0 5 1 5 3 0 3 3 0 2 4
11 551 012	500	130	12x 7x 9	0,7	10 4	0 0 5 1 5 3 0 3 3 0 3 1
11 551 020	500	130	halbrund	0,7	10 4	0 0 5 1 5 3 0 5 9 3 8 3
10 551 004	500	130	4x 4	0,7	10 4	0 0 5 1 5 3 0 3 3 0 6 2
10 551 006	500	130	6x 6	0,7	10 4	0 0 5 1 5 3 0 3 3 0 7 9
10 551 008	500	130	8x 8	0,7	10 4	0 0 5 1 5 3 0 3 3 0 8 6
10 551 010	500	130	10x10	0,7	10 4	0 0 5 1 5 3 0 3 3 0 9 3
10 551 012	500	130	12x 7x 9	0,7	10 4	0 0 5 1 5 3 0 3 3 1 0 9
10 551 020	500	130	halbrund	0,7	10 4	0 0 5 1 5 3 0 3 3 1 1 6

Ⓓ L = Länge
B = Breite
S = Blattstärke

Ⓔ L = Length
B = Width
S = Thickness of the blade

Ⓕ L = Longueur
B = Largeur
S = Grosseur du lame

Belgische Glättekellen

Plastering trowels, Belgian-type
Platoir étroite, type Belge

Die Kellenmacher!
Made in Germany



Belgische Glättekelle

Plastering trowel, Belgian-type
Platoir étroite, type Belge

schmal (Griff offen)
open handle
manche ouvert

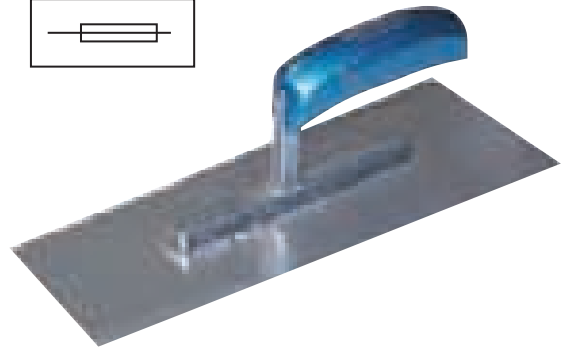
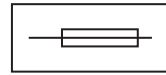

Art.-Nr.	L mm	B mm	S mm	
11 574 280	280	102	0,7	10 ₄



Belgische Glättekelle

Plastering trowel, Belgian-type
Platoir étroite, type Belge

mit balligem Holzgriff, geschlossen
straight, with ball-shaped wooden handle, closed
bout droit, avec poigné en bois bombée

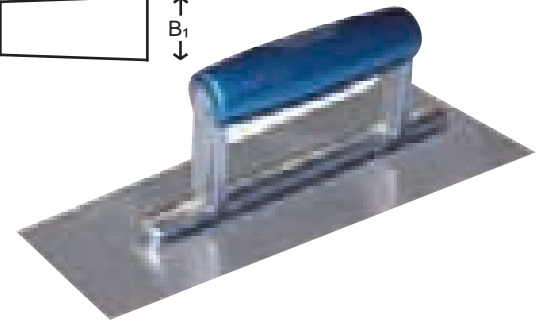

Art.-Nr.	L mm	B ₁ mm	B ₂ mm	S mm	
11 573 280	280	110	80	0,8	10 ₄



Belgische Glättekelle, vorne rund

Plastering trowel
Platoir, type floreffé

mit balligem Holzgriff, geschlossen
Belgian-type, round, with ball-shaped wooden handle, closed
bout rond, avec poignée en bois bombée

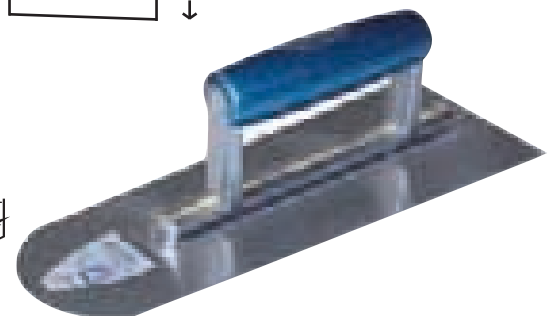

Art.-Nr.	L mm	B ₁ mm	B ₂ mm	S mm	
11 570 007	280	110	80	1,0	10 ₄



10 570 012	280	110	80	0,7	10 ₄
------------	-----	-----	----	-----	-----------------



mod. Belg. „Floreffé“	11 570 012	280	110	80	1,2	10 ₄
-----------------------	------------	-----	-----	----	-----	-----------------





Die Kellenmacher!

Made in
Germany

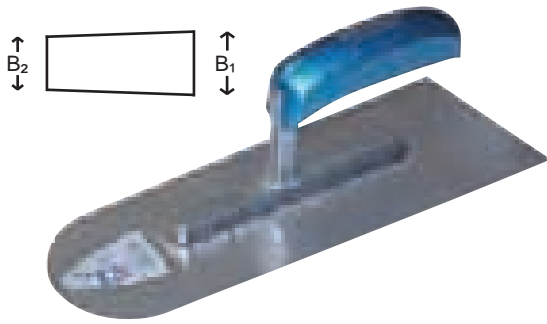

Belgische Kellen

Trowels, Belgian-type
Platoir, type Belge



**Belgische Glättkelle, vorne rund
mit geschweiftem Holzgriff, offen**

Plastering trowel, Belgian-type, round open handle
Platoir, façon florefe, bout rond, manche ouvert

Art.-Nr.	$\frac{L}{mm}$	$\frac{B_1}{mm}$	$\frac{B_2}{mm}$	$\frac{S}{mm}$		
11 571 007	280	100	80	0,7	10 ₄	
mod. Belg. „Florefe“						
11 571 012	280	100	80	1,2	10 ₄	



2.10

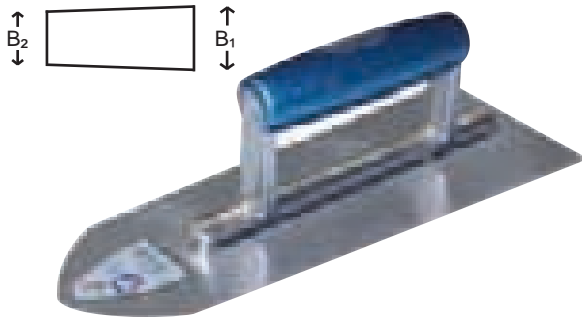



Belgische Glättkelle „Tournai“

Plastering trowel
Platoir, type Tournai

mit balligem Holzgriff, geschlossen

Tournai-type, with ball-shaped wooden handle, closed

avec poignée en bois bombée

Art.-Nr.	$\frac{L}{mm}$	$\frac{B_1}{mm}$	$\frac{B_2}{mm}$	$\frac{S}{mm}$		
11 572 012	260	90	80	1,2	10 ₄	

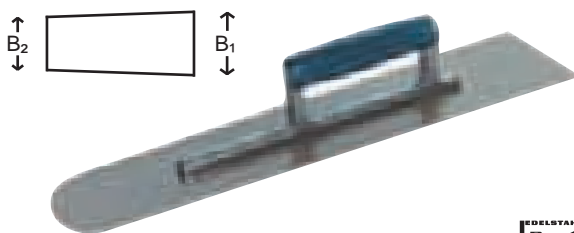





Belgische Bodenlegerkelle

Flooring trowel
Platoir type chape

vorne rund, mit balligem Holzgriff, geschlossen

Belgian-type, round, with ball-shaped wooden handle, closed

type Belge, bout rond, avec poignée en bois bombée

Art.-Nr.	$\frac{L}{mm}$	$\frac{B_1}{mm}$	$\frac{B_2}{mm}$	$\frac{S}{mm}$		
11 565 450	450	110	80	1,0	10 ₄	
11 565 500	500	110	80	1,2	10 ₄	
10 565 450	450	110	80	1,2	10 ₄	



Ⓓ L = Länge
B = Breite
S = Blattstärke

ⒼⒷ L = Length
B = Width
S = Thickness of the blade

Ⓕ L = Longueur
B = Largeur
S = Grosseur du lame

Die Kellenmacher!

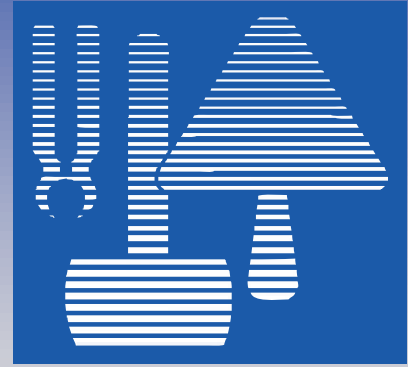

HAROMAC[®]
WERKZEUGFABRIK

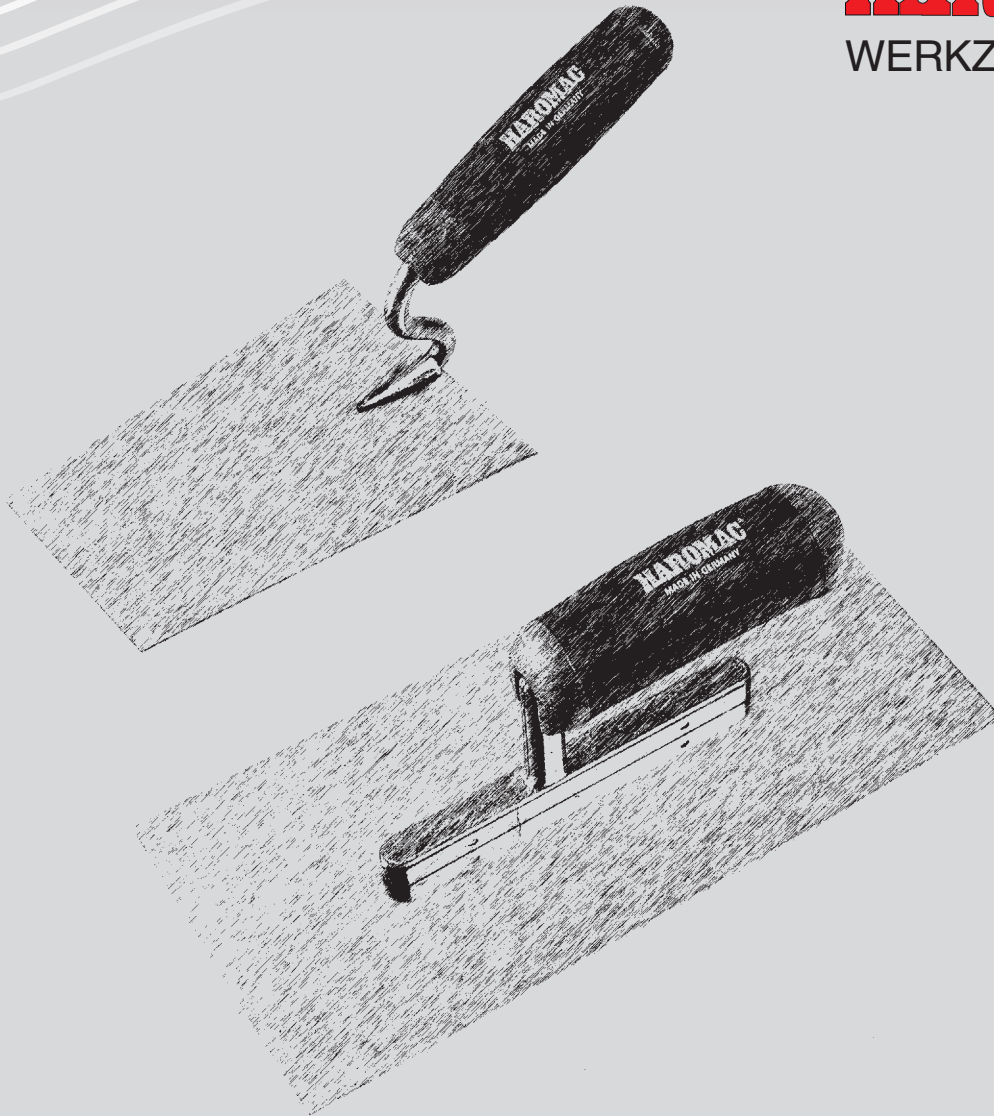

SOFTGRIFFKELLEN

ERGO-SOFTGRIP-TROWELS

TRUELLES AVEC POIGNÉE ERGOSOFT

TRUELLES AVEC
POIGNÉE ERGOSOFT

ERGO-SOFTGRIP-
TROWELS

SOFTGRIFF-
KELLEN

2-Komponenten Ergo-Softgriffkellen

2-component Ergo-Softgrip-Trowels
Truelle avec poignée Ergosoft

Die Kellenmacher!
Made in Germany



Qualität und Vielfalt Quality and assortment Qualité et aiversité



Harter, stabiler PP- Kern,
für dauerhaft festen
Halt der Angel.

Harte Kunststoffkappe,
zum „Klopfen“ geeignet

Extrem griffige Oberfläche
durch weiche Komponente,
besonders geeignet bei Feuchtigkeit,
leicht zu reinigen.



Die Kellenmacher!
 Made in Germany

2-Komponenten Ergo-Softgriffkellen

2-component Ergo-Softgrip-Trowels
 Truelle avec poignée Ergosoft

2-Komponenten-Softgriff Profi-Ausführung.

Die besondere Ausführung ist wie ein Holzgriff geformt. Das ballige Glättekeltenheft gibt festen Halt und ermöglicht hohe Kraftübertragung. Diese Ausführung ist bei Handwerkern sehr beliebt.



2-Komponenten Ergo-Softgriff für Kellen

2K soft feel Ergo-handle, for trowels
 Poignée Ergosoft, pour platoires

Art.-Nr.		Farbe
HE 510 050 BLS	Gr. 0 (Glättekelten)	Blau-Schwarz
HE 510 050 GLB	Gr. 0 (Glättekelten)	Gelb-Schwarz
HE 510 050 BLA	Gr. 0 (Glättekelten)	Blau-Grau
HE 510 050 ROT	Gr. 0 (Glättekelten)	Rot-Schwarz
HE 010 050 BLS	Gr. 1 (Kellen, klein)	Blau-Schwarz
HE 010 050 GLB	Gr. 1 (Kellen, klein)	Gelb-Schwarz
HE 010 050 BLA	Gr. 1 (Kellen, klein)	Blau-Grau
HE 010 050 ROT	Gr. 1 (Kellen, klein)	Rot-Schwarz
HE 020 050 BLS	Gr. 2 (Kellen, groß)	Blau-Schwarz
HE 020 050 GLB	Gr. 2 (Kellen, groß)	Gelb-Schwarz
HE 020 050 BLA	Gr. 2 (Kellen, groß)	Blau-Grau
HE 020 050 ROT	Gr. 2 (Kellen, groß)	Rot-Schwarz

2-Komponenten-Softgriff mit Fingerschutz und Griffmulden.

Die besondere Ausführung vermeidet ungewolltes Abrutschen und ist bei Heimwerkern sehr beliebt.

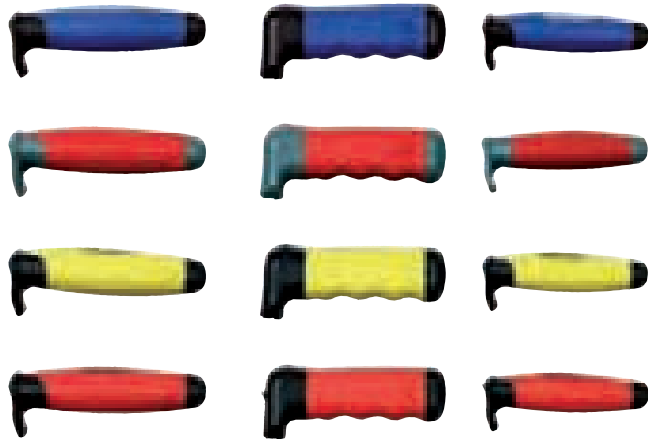

HE 510 051 BLS	Gr. 0 (Glättekelten)	Blau-Schwarz
HE 510 051 CRRR	Gr. 0 (Glättekelten)	Rot-Grau
HE 510 051 GLB	Gr. 0 (Glättekelten)	Gelb-Schwarz
HE 510 051 ROT	Gr. 0 (Glättekelten)	Rot-Schwarz
HE 010 051 BLS	Gr. 1 (Kellen, klein)	Blau-Schwarz
HE 010 051 CRRR	Gr. 1 (Kellen, klein)	Rot-Grau
HE 010 051 GLB	Gr. 1 (Kellen, klein)	Gelb-Schwarz
HE 010 051 ROT	Gr. 1 (Kellen, klein)	Rot-Schwarz
HE 020 051 BLS	Gr. 2 (Kellen, groß)	Blau-Schwarz
HE 020 051 CRRR	Gr. 2 (Kellen, groß)	Rot-Grau
HE 020 051 GLB	Gr. 2 (Kellen, groß)	Gelb-Schwarz
HE 020 051 ROT	Gr. 2 (Kellen, groß)	Rot-Schwarz

Mauerkelle, S-Hals mit 2K-Ergo-Softgriff

Maison's trowel, German-type, swan's neck with 2K soft feel Ergo-handle

Truelle de plâtrier, avec col de cygne, avec poignée Ergosoft

Wichtiger Sortimentsartikel!



Art.-Nr.	L mm	B ₁ mm	B ₂ mm	X = Grifffarbe							
				1	2	3	4	5	6	7	5
12 020 160 x	160	115	85	1	2	3	4	5	6	7	5
12 020 180 x	180	125	95	1	2	3	4	5	6	7	5
13 020 160 x	160	115	85	1	2	3	4	5	6	7	5
13 020 180 x	180	125	95	1	2	3	4	5	6	7	5
13 020 200 x	200	140	105	1	2	3	4	5	6	7	5

Ⓧ = Bitte Griff ergänzen Ⓞ = x = please insert grip ⓕ = X = compléter poignée si vous plaît
 L = Länge L = Length L = Longueur
 B = Breite B = Width B = Largeur
 S = Blattstärke S = Thickness of the blade S = Grosseur du lame

2-Komponenten Ergo-Softgriffkellen

2-component Ergo-Softgrip-Trowels

Truelle avec poignée Ergosoft

Die Kellenmacher!

Made in Germany



Maurerkelle, G-Hals

mit 2K-Ergo-Softgriff

Mason's trowel, German-type, straight neck with 2K soft feel Ergo-handle

Truelle de plâtrier, avec col droit, avec poignée Ergosoft

Art.-Nr. L B₁ B₂ X = Grifffarbe

Art.-Nr.	L mm	B ₁ mm	B ₂ mm	X = Grifffarbe
12 021 180 x	180	95	125	1 2 3 4 5 6 7 5
13 021 180 x	180	95	125	1 2 3 4 5 6 7 5



Berner Putzkelle

mit 2K-Ergo-Softgriff

Plasterer's trowel, Bern-type with 2K soft feel Ergo-handle

Truelle de plâtrier, type Berne, avec poignée Ergosoft

Art.-Nr. L B₁ B₂ X = Grifffarbe

Art.-Nr.	L mm	B ₁ mm	B ₂ mm	X = Grifffarbe
12 060 120 x	120	55	80	1 2 3 4 5 6 7 10
12 060 140 x	140	60	85	1 2 3 4 5 6 7 10
12 060 160 x	160	65	85	1 2 3 4 5 6 7 10
13 060 120 x	120	55	80	1 2 3 4 5 6 7 10
13 060 140 x	140	60	85	1 2 3 4 5 6 7 10
13 060 160 x	160	65	85	1 2 3 4 5 6 7 10



Wichtiger Sortimentsartikel!

Stukkateurspachtel

mit 2K-Ergo-Softgriff

Plasterer's spatula with 2K soft feel Ergo-handle

Couteau de plâtrier, avec poignée 2K-Ergosoft

Art.-Nr. L B X = Grifffarbe

Art.-Nr.	L mm	B mm	X = Grifffarbe
12 010 040 x	90	40	1 2 3 4 5 6 7 10
12 010 050 x	95	50	1 2 3 4 5 6 7 10
12 010 060 x	100	60	1 2 3 4 5 6 7 10
12 010 080 x	110	80	1 2 3 4 5 6 7 10
12 010 100 x	120	100	1 2 3 4 5 6 7 10
13 010 040 x	90	40	1 2 3 4 5 6 7 10
13 010 050 x	95	50	1 2 3 4 5 6 7 10
13 010 060 x	100	60	1 2 3 4 5 6 7 10
13 010 070 x	100	70	1 2 3 4 5 6 7 10
13 010 080 x	110	80	1 2 3 4 5 6 7 10
13 010 100 x	120	100	1 2 3 4 5 6 7 10
13 010 120 x	120	120	1 2 3 4 5 6 7 10



Wichtiger Sortimentsartikel!

Ⓛ x = Bitte Griff ergänzen Ⓒ x = please insert grip Ⓕ x = complétez poignée sil vous plaît
 L = Länge L = Length L = Longueur
 B = Breite B = Width B = Largeur
 S = Blattstärke S = Thickness of the blade S = Grosseur du lame



Die Kellenmacher!

Made in Germany

2-Komponenten Ergo-Softgriffkellen

2-component Ergo-Softgrip-Trowels

Truelle avec poignée Ergosoft



Katzenzunge

mit 2K-Ergo-Softgriff

Plasterer's trowel, tongue shaped with 2K soft feel Ergo-handle

Truelle langue de chat, avec poignée Ergosoft

Art.-Nr.	L mm	B mm	X = Grifffarbe									
12 070 140 x	140	52		1	2	3	4	5	6	7	10	
12 070 160 x	160	58		1	2	3	4	5	6	7	10	
13 070 140 x	140	52		1	2	3	4	5	6	7	10	
13 070 160 x	160	58		1	2	3	4	5	6	7	10	



Hamburger Putzkelle

mit 2K-Ergo-Softgriff

Plasterer's trowel, Hamburg-type with 2K soft feel Ergo-handle

Truelle à polir, type Hambourg, avec poignée Ergosoft

Art.-Nr.	L mm	B mm	X = Grifffarbe									
12 080 140 x	140	80		1	2	3	4	5	6	7	10	
13 080 140 x	140	80			1	2	3	4	5	6	7	10

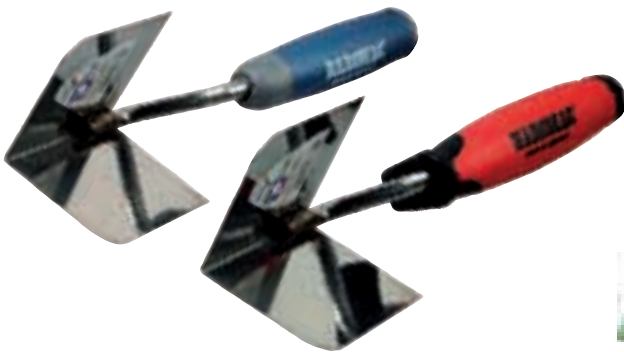

Eckenkelle, innen

mit 2K-Ergo-Softgriff

Corner trowel, inside, edged with 2K soft feel Ergo-handle

Truelle pour coins intérieurs, avec poignée Ergosoft

Art.-Nr.	L mm	B mm	X = Grifffarbe									
12 210 080 x	80	60		1	2	3	4	5	6	7	10	
12 210 090 x	90	80		1	2	3	4	5	6	7	10	
12 210 100 x	100	100		1	2	3	4	5	6	7	10	



Eckenkelle, außen

mit 2K-Ergo-Softgriff

Corner trowel, outside, round with 2K soft feel Ergo-handle

Truelle pour coins extérieurs, avec poignée Ergosoft

Art.-Nr.	L mm	B mm	X = Grifffarbe									
12 220 080 x	80	60		1	2	3	4	5	6	7	10	
12 220 090 x	90	80		1	2	3	4	5	6	7	10	
12 220 100 x	100	100		1	2	3	4	5	6	7	10	

(D) x = Bitte Griff ergänzen (GB) x = please insert grip (F) x = complétez poignée si vous plaî
 L = Länge L = Length L = Longueur
 B = Breite B = Width B = Largeur
 S = Blattstärke S = Thickness of the blade S = Grosseur du lame

2-Komponenten Ergo-Softgriffkellen

2-component Ergo-Softgrip-Trowels
Truelle avec poignée Ergosoft

Die Kellenmacher!
Made in Germany



Berliner Maurerkelle mit 2K-Ergo-Softgriff

Plastering trowel with 2K soft feel Ergo-handle
Platoir avec poignée Ergosoft

Art.-Nr.	L mm	B mm	X = Grifffarbe								
			1	2	3	4	5	6	7	5	
13 027 180 x	180	160									
13 027 200 x	200	175									
13 027 220 x	220	200									
13 027 240 x	240	213									



Fugenkelle, Form D, lang mit 2K-Ergo-Softgriff

Plastering trowel with 2K soft feel Ergo-handle
Platoir avec poignée Ergosoft

Art.-Nr.	L mm	B mm	S mm	X = Grifffarbe				5
				1	2	3	4	
13 330 008 x	180	8	1,9					10
13 330 010 x	180	10	1,9					10
13 330 012 x	180	12	1,9					10



Arnheimer Ziegelkelle, rechts mit 2K-Ergo-Softgriff

Maison's trowel, Arnhem-type, swan's neck with 2K soft feel Ergo-handle
Truelle de plâtrier, avec col de cygne, avec poignée Ergosoft

Art.-Nr.	L mm	B mm	X = Grifffarbe								
			1	2	3	4	5	6	7	5	
12 117 180 x	180	145									



Arnheimer Ziegelkelle, links mit 2K-Ergo-Softgriff

Maison's trowel, Arnhem-type, swan's neck with 2K soft feel Ergo-handle
Truelle de plâtrier, avec col de cygne, avec poignée Ergosoft

Art.-Nr.	L mm	B mm	X = Grifffarbe								
			1	2	3	4	5	6	7	5	
12 118 180 x	180	145									



Ⓛ x = Bitte Griff ergänzen Ⓜ x = please insert grip Ⓧ x = complétez poignée sil vous plaît
L = Länge L = Length L = Longueur
B = Breite B = Width B = Largeur
S = Blattstärke S = Thickness of the blade S = Grosseur du lame



Wichtiger Sortimentsartikel!

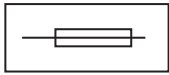

Glättekelle

mit 2K-Ergo-Softgriff

Plastering trowel with 2K soft feel Ergo-handle

Platoir avec poignée Ergosoft



Art.-Nr.	L mm	B mm	S mm	X = Grifffarbe									
				1	2	3	4	5	6	7	10		
12 510 280 x	280	130	0,7	1	2	3	4	5	6	7	10		
13 510 280 x	280	130	0,7	1	2	3	4	5	6	7	10		

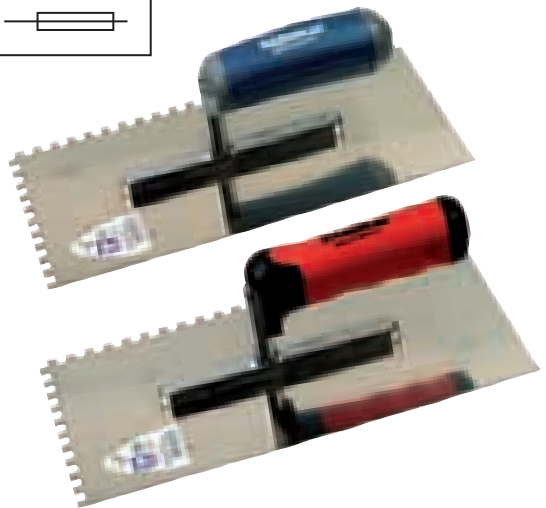
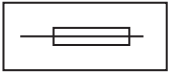

Gezahnte Glättekelle

mit 2K-Ergo-Softgriff

Notched plastering trowel with 2K soft feel Ergo-handle

Platoir dentelée avec poignée Ergosoft



Art.-Nr.	L mm	B mm	Zahn	S mm	X = Grifffarbe									
					1	2	3	4	5	6	7	10		
12 515 004 x	280	130	4x 4	0,7	1	2	3	4	5	6	7	10		
12 515 006 x	280	130	6x 6	0,7	1	2	3	4	5	6	7	10		
12 515 008 x	280	130	8x 8	0,7	1	2	3	4	5	6	7	10		
12 515 010 x	280	130	10x10	0,7	1	2	3	4	5	6	7	10		
13 515 004 x	280	130	4x 4	0,7	1	2	3	4	5	6	7	10		
13 515 006 x	280	130	6x 6	0,7	1	2	3	4	5	6	7	10		
13 515 008 x	280	130	8x 8	0,7	1	2	3	4	5	6	7	10		
13 515 010 x	280	130	10x10	0,7	1	2	3	4	5	6	7	10		

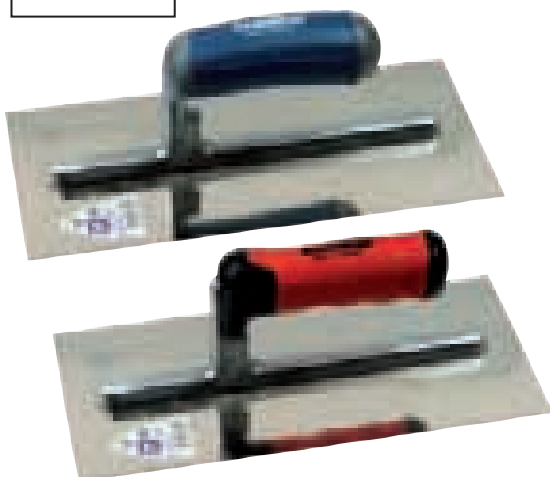
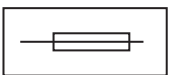

Glättekelle, lange Stütze

mit 2K-Ergo-Softgriff

Plastering trowel with 2K soft feel Ergo-handle, long support

Platoir avec poignée Ergosoft

extra Stark durch 9-fache Vernietung, speziell für anspruchsvolle Arbeiten mit Betonwerkstoffen

extra strong by 9 gold riveting, specially for using by concrete material

longue et léger mouture en aluminium



Art.-Nr.	L mm	B mm	S mm	X = Grifffarbe									
				1	2	3	4	5	6	7	10		
12 503 280 x	280	130	0,7	1	2	3	4	5	6	7	10		
12 503 330 x	330	130	0,7	1	2	3	4	5	6	7	10		
12 503 405 x	405	130	0,7	1	2	3	4	5	6	7	10		
13 503 280 x	280	130	0,7	1	2	3	4	5	6	7	10		
13 503 330 x	330	130	0,7	1	2	3	4	5	6	7	10		
13 503 405 x	405	130	0,7	1	2	3	4	5	6	7	10		

Ⓓ x = Bitte Griff ergänzen Ⓔ x = please insert grip Ⓕ x = complétez poignée sil vous plaît
 L = Länge L = Length L = Longueur
 B = Breite B = Width B = Largeur
 S = Blattstärke S = Thickness of the blade S = Grosseur du lame

2-Komponenten Ergo-Softgriffkellen

2-component Ergo-Softgrip-Trowels
Truelle avec poignée Ergosoft

Die Kellenmacher!
Made in Germany



Glättkelle, lange Stütze, 9-fach vernietet mit 2K-Ergo-Softgriff, mit runden Kanten



Plastering trowel with 2K soft feel Ergo-handle, long support
Platoir avec poignée Ergosoft

extra Stark durch 9-fache Vernietung, speziell für anspruchsvolle Arbeiten mit Betonwerkstoffen und Putzarbeiten

extra strong by 9 gold riveting, specially for using by concrete material

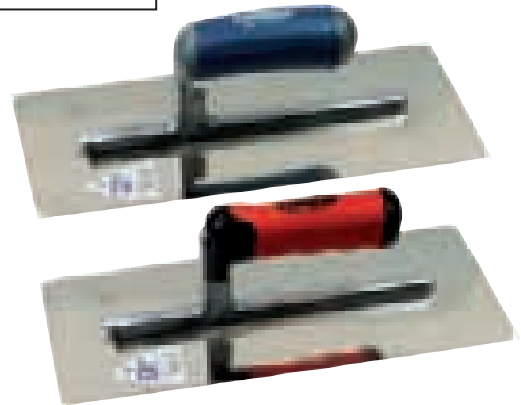
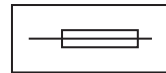
longue et léger mouture en aluminium





Art.-Nr.	L mm	B mm	S mm	X = Grifffarbe								
				1	2	3	4	5	6	7		10
 12 504 330 x	330	130	0,7	1	2	3	4	5	6	7	10	
 13 504 330 x	330	130	0,7	1	2	3	4	5	6	7	10	

Glättkelle, Papillon gezahnt mit 2K-Ergo-Softgriff

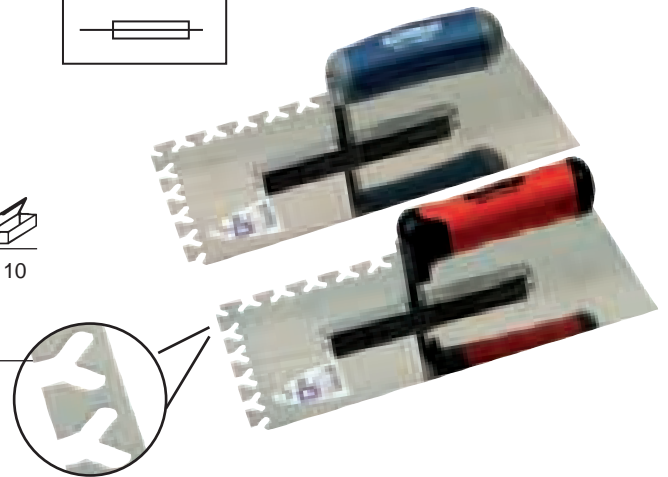
Plastering trowel with 2K soft feel Ergo-handle
Platoir avec poignée Ergosoft



Art.-Nr.	L mm	B mm	S mm	X = Grifffarbe								
				1	2	3	4	5	6	7		10
 12 515 050 x	280	130	0,7	1	2	3	4	5	6	7	10	

- (D) x = Bitte Griff ergänzen (GB) x = please insert grip (F) x = complétez poignée sil vous plaît
 L = Länge L = Length L = Longueur
 B = Breite B = Width B = Largeur
 S = Blattstärke S = Thickness of the blade S = Grosseur du lame



Die Kellenmacher!

Made in Germany

Griechische Ergo-Softgriffkellen

2-component Ergo-Softgrip-Trowels greece type

Truelle avec poignée Ergosoft, type grec

Griechische Kelle, schräge Schulter mit 2K-Ergo-Softgriff

Trowel, Greek-type, bevelled shoulder with 2K soft feel Ergo-handle

Truelle de plâtrier, type grec, épaule obliquité, avec poignée Ergosoft



Art.-Nr.	L mm	X = Grifffarbe									
12 430 200 x	200	1	2	3	4	5	6	7	10		
12 430 220 x	220	1	2	3	4	5	6	7	10		
12 430 240 x	240	1	2	3	4	5	6	7	10		
12 430 260 x	260	1	2	3	4	5	6	7	10		
12 430 280 x	280	1	2	3	4	5	6	7	10		

Griechische Kelle, gerade Schulter mit 2K-Ergo-Softgriff

Trowel, Greek-type, straight shoulder, with 2K soft feel Ergo-handle

Truelle de plâtrier, type grec, épaule droit, avec poignée Ergosoft



Art.-Nr.	L mm	X = Grifffarbe									
12 431 200 x	200	1	2	3	4	5	6	7	10		
12 431 220 x	220	1	2	3	4	5	6	7	10		
12 431 240 x	240	1	2	3	4	5	6	7	10		
12 431 260 x	260	1	2	3	4	5	6	7	10		
12 431 280 x	280	1	2	3	4	5	6	7	10		

Holländische Ergo-Softgriffkellen

2-component Ergo-Softgrip-Trowels dutch type

Truelle avec poignée Ergosoft, type Pays-bas

Die Kellenmacher!

Made in Germany



Holländische Pliesterkelle, rund mit 2K-Ergo-Softgriff

Maison's trowel, Arnhem-type, swan's neck with 2K soft feel Ergo-handle

Truelle de plâtrier, avec col de cygne, avec poignée Ergosoft

Art.-Nr.	L mm	B mm	X = Grifffarbe							
			1	2	3	4	5	6	7	
12 215 140 x	140	103								
12 215 160 x	160	103								



Holländische Pliesterkelle, spitz mit 2K-ErgoSoftgriff

Maison's trowel, Arnhem-type, swan's neck with 2K soft feel Ergo-handle

Truelle de plâtrier, avec col de cygne, avec poignée Ergosoft

Art.-Nr.	L mm	B mm	X = Grifffarbe							
			1	2	3	4	5	6	7	
12 216 140 x	140	95								
12 216 160 x	160	110								





Die Kellenmacher!

Made in Germany

Portugiesische Ergo-Softgriffkellen

2-component Ergo-Softgrip-Trowels portugese type

Truelle avec poignée Ergosoft, type Portugese



Portugiesische Kelle, gerade Schulter mit 2K-Ergo-Softgriff

Maison's trowel, Arnhem-type, swan's neck with 2K soft feel Ergo-handle

Truelle de plâtrier, avec col de cygne, avec poignée Ergosoft

Art.-Nr.	L mm	B ₁ mm	B ₂ mm	X = Grifffarbe									
				1	2	3	4	5	6	7	10		
12 400 200 x	200	54	118	1	2	3	4	5	6	7	10		
12 400 220 x	220	55	120	1	2	3	4	5	6	7	10		
12 400 240 x	240	58	125	1	2	3	4	5	6	7	10		
13 400 200 x	200	54	118	1	2	3	4	5	6	7	10		
13 400 220 x	220	55	120	1	2	3	4	5	6	7	10		
13 400 240 x	240	58	125	1	2	3	4	5	6	7	10		



Portugiesische Kelle, schräge Schulter mit 2K-Ergo-Softgriff

Maison's trowel, Arnhem-type, swan's neck with 2K soft feel Ergo-handle

Truelle de plâtrier, avec col de cygne, avec poignée Ergosoft

Art.-Nr.	L mm	B ₁ mm	B ₂ mm	X = Grifffarbe									
				1	2	3	4	5	6	7	10		
12 401 200 x	200	45	120	1	2	3	4	5	6	7	10		
12 401 220 x	220	45	122	1	2	3	4	5	6	7	10		
12 401 240 x	240	45	134	1	2	3	4	5	6	7	10		
13 401 200 x	200	45	120	1	2	3	4	5	6	7	10		
13 401 220 x	220	45	122	1	2	3	4	5	6	7	10		
13 401 240 x	240	45	134	1	2	3	4	5	6	7	10		



Portugiesische Spitzkelle, vorne spitz mit 2K-Ergo-Softgriff

Maison's trowel, Arnhem-type, swan's neck with 2K soft feel Ergo-handle

Truelle de plâtrier, avec col de cygne, avec poignée Ergosoft

Art.-Nr.	L mm	B mm	X = Grifffarbe									
			1	2	3	4	5	6	7	10		
12 403 125 x	125	70	1	2	3	4	5	6	7	10		
13 403 125 x	125	70	1	2	3	4	5	6	7	10		



Portugiesische Spitzkelle, vorne rund mit 2K-Ergo-Softgriff

Maison's trowel, Arnhem-type, swan's neck with 2K soft feel Ergo-handle

Truelle de plâtrier, avec col de cygne, avec poignée Ergosoft

Art.-Nr.	L mm	B mm	X = Grifffarbe									
			1	2	3	4	5	6	7	10		
12 404 125 x	125	70	1	2	3	4	5	6	7	10		
13 404 125 x	125	70	1	2	3	4	5	6	7	10		

(D) x = Bitte Griff ergänzen (GB) x = please insert grip (F) x = complétez poignée sil vous plaît
 L = Länge L = Length L = Longueur
 B = Breite B = Width B = Largeur
 S = Blattstärke S = Thickness of the blade S = Grosseur du lame

Portugiesische Ergo-Softgriffkellen

2-component Ergo-Softgrip-Trowels portugese type

Truelle avec poignée Ergosoft, type Portugese

Die Kellenmacher!

Made in Germany



Portugiesische Kelle, engl. Mod.

mit 2K-Ergo-Softgriff

Maison's trowel, Arnhem-type, swan's neck with 2K soft feel Ergo-handle

Truelle de plâtrier, avec col de cygne, avec poignée Ergosoft



Art.-Nr.	L mm	B ₁ mm	B ₂ mm	X = Grifffarbe								
				1	2	3	4	5	6	7	10	
13 402 240 x	240	110	10									



(D) x = Bitte Griff ergänzen (GB) x = please insert grip (F) x = complétez poignée sil vous plaît
 L = Länge L = Length L = Longueur
 B = Breite B = Width B = Largeur
 S = Blattstärke S = Thickness of the blade S = Grosseur du lame