

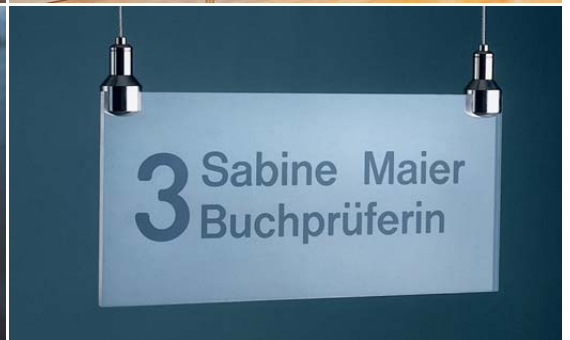

POSILOCK

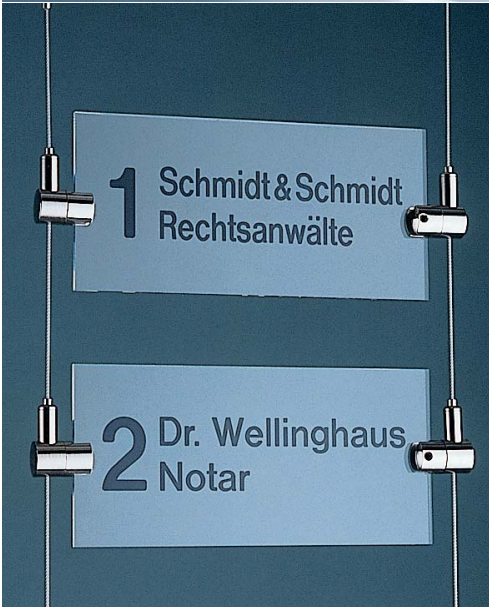

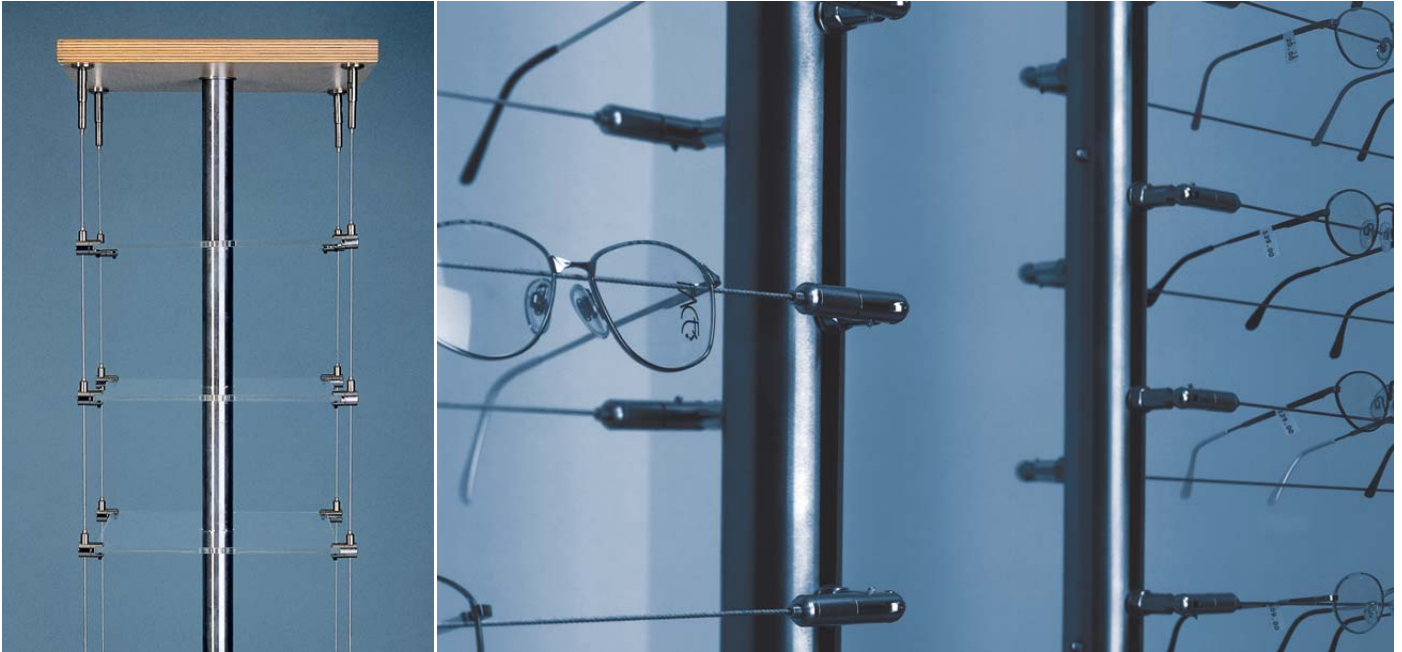

Ob im Ladenbau, in der Innenarchitektur oder bei der Dekoration – gefragt sind transparente Lösungen, die ihre Funktion mit Leichtigkeit und Eleganz erfüllen.

POSILOCK bietet hierfür ein ganzes System von Möglichkeiten – von der Decken- bis zur Bodenbefestigung, zum Abhängen von Bilderrahmen, Displays und Objekten. Das innovative, hochwertige Seilsystem von Carl Stahl lässt Ihrer Kreativität freien Spielraum und erleichtert mit durchdachten Komponenten den Einsatz und die Montage.

In the fields of interior design, retail display and visual communication, **POSILOCK** fills the need for a transparent, versatile cable suspension system. The emphasis on high quality, functional components permits you to create designs that achieve dramatic results.

Lorsque, dans des domaines tels que la décoration, l'agencement ou l'architecture intérieure, les montages en câble doivent être élégants et légers, on pense aussitôt au système **POSILOCK**. Le système de câble et accessoires **POSILOCK** vous propose une multitude de possibilités – de la fixation haute jusqu'à la fixation basse, en passant par la suspension de tableaux d'objets décoratifs ou de signalétique. Le système de câble de Carl Stahl est innovant et de grande qualité. Grâce à ses embouts spécialement conçus, il laisse libre cours à votre imagination et facilite à la mise en œuvre et le montage de votre projet.

Ø 1,0 - 1,8 mm

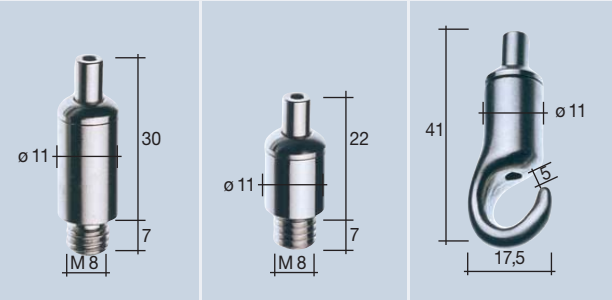

Seilspanner, verstellbar |¹
Adjustable cable tensioner
Tendeur réglable

Y0200

Seilspanner, kurz verstellbar |¹
Small adjustable cable tensioner
Tendeur réglable court

Y0203

Haken, verstellbar |¹⁵
Adjustable hook
Crochet réglable

Y0605

Ø 2,0 - 3,0 mm

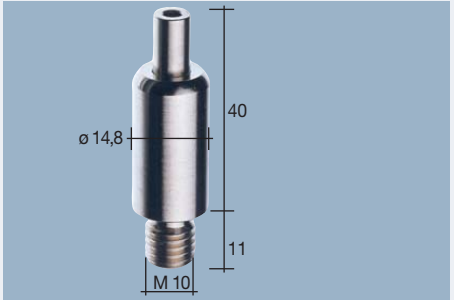

Seilspanner, verstellbar |¹
Adjustable cable tensioner
Tendeur réglable

YB900



Seilhalter, verstellbar |¹
Adjustable cable holder
Support câble réglable

Y0201



Zylinderhülse |⁸
(verpresst mit Seil ø 1,5 mm)

Cylinder termination
(swaged to rope ø 1,5 mm)

Douille cylindrique
(sertie sur câble ø 1,5 mm)

500 mm **YZH05**

1 000 mm **YZH10**

2 000 mm **YZH20**

Sonderlängen auf Anfrage
Special lengths on request
Autres longueurs sur demande



Endhülse |³
(verpresst mit Seil ø 2,0 mm)

End termination
(swaged to rope ø 2,0 mm)

Douille terminale
(sertie sur câble ø 2,0 mm)

500 mm **YEH05**

1 000 mm **YEH10**

2 000 mm **YEH20**

Sonderlängen auf Anfrage
Special lengths on request
Autres longueurs sur demande

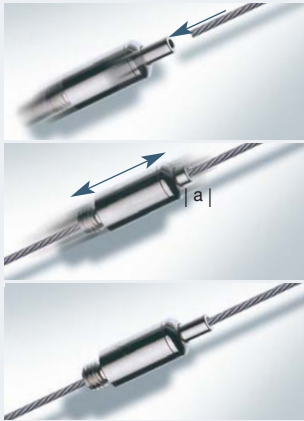

Seilspanner
Cable tensioner
Tendeur réglable

- 1| Das Seil wird in den eingedrückt Stift am Seilspanner eingeführt. In der gewünschten Position den Stift loslassen und damit den Spanner arretieren.

The rope is inserted into the fitting by pressing the top pin. The pin is released as soon as the fitting is in the right position and the automatic locking mechanism will keep the fitting in position.

Appuyer sur l'ergot du tendeur réglable. Introduire le câble dans cet ergot et le faire coulisser jusqu'à la position souhaitée. Relâcher l'ergot, le câble est alors bloqué.

- 2| Durch Eindrücken des Stiftes (a) wird der automatische Spanmechanismus wieder gelöst – eine neue Position kann gewählt werden.

By repressing the pin, the locking mechanism will be released and the fitting can be repositioned.

En appuyant sur l'ergot le système de tension est relâché et une nouvelle position peut être choisie librement.



Seilhalter
Cable holder
Support câble

- 1| Der Seilhalter wird mit einer seitlichen Inbusschraube in der gewünschten Position am Seil befestigt (Mechanismus 1).

The cable holder is fixed in position by tightening the hexagon screw.

Le support de câble se fixe sur le câble par une vis latérale à la position souhaitée.



- 2| Durch eine verpresste Zylinderhülse am Seilende erhält man einen frei drehbaren Anschlagpunkt mit einer höheren Festigkeit.

By using the cylinder termination at the end of the rope, a swivelling attachment point is created.

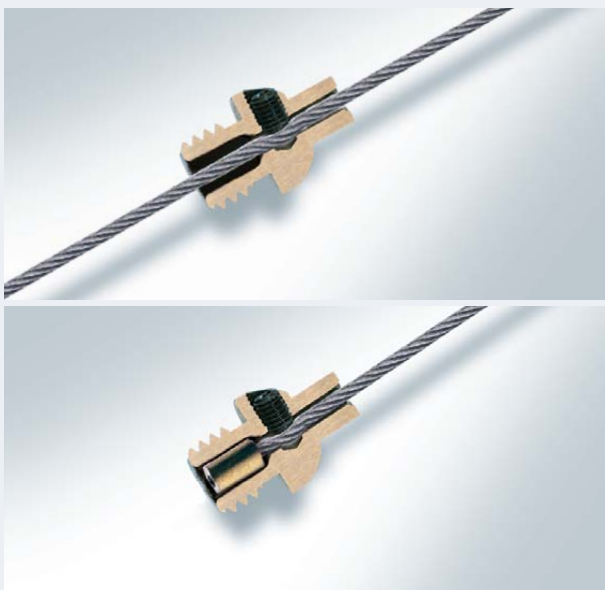
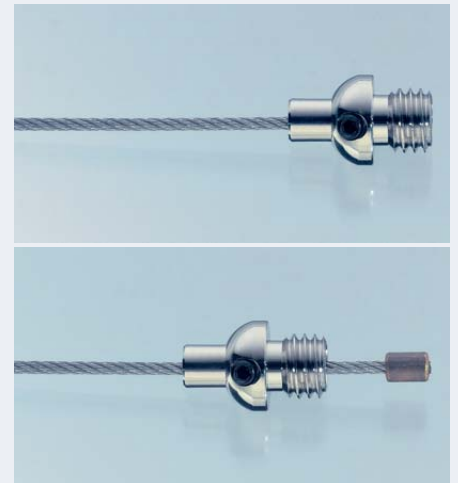

En sertissant une douille cylindrique à un bout du câble, on obtient un embout pivotant beaucoup plus résistant.





Ø 1,0 - 1,8 mm

	
Klemmen für Seil ⁴ Crimps Manchon	Kauschen für Seil ³ Thimbles Cosse
ø 1 mm Y0061	ø 1 mm Y0071
ø 1,5 mm Y0062	ø 1,5 - 1,8 mm Y0072
ø 1,8 mm Y0063	

Ø 2,0 - 3,0 mm

			
Verbindungsstück ¹ Adapter Raccord	Gelenkhalter ¹ Elbow holder Support articulé	Distanzhalter ¹ Extension fitting Entretoise	Boden-/Deckenhalter ¹ Mounting plate attache sol/plafond
Y0300	Y0660	Y0310	Y0720S

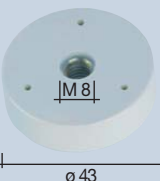
	
Verbindungsstück ¹ Adapter Raccord	Gelenkhalter ¹ Elbow holder Support articulé
YB980	YB910

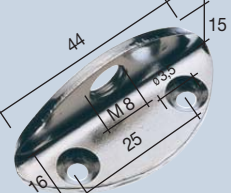
			
Magnet, weiß ummantelt ⁹ Magnet, white coated Aimant gainé blanc	Scheibe ¹ Cover disk Platine	Winkel ⁷ Small angle bracket Equerre	Winkel groß ⁷ Large angle bracket Equerre double
YMG01	Y0320	Y0401	Y0402

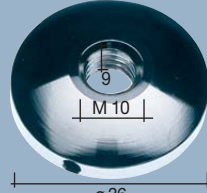
Scheibe ¹ Cover disk Platine
YB960

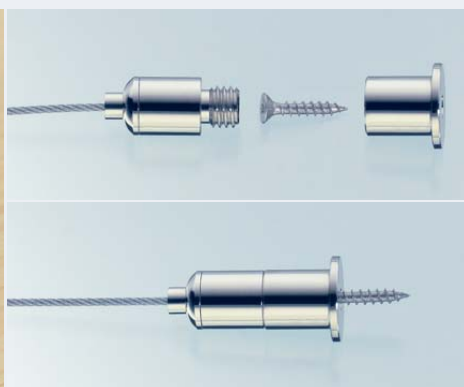

Ø 1,0 - 1,8 mm

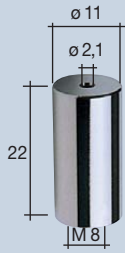

Hülse drehbar |¹
Cylinder anchor
Douille pivotante

Y0305

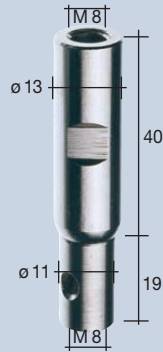

Komfortspanner,
frei drehbar |¹
Swivelling comfort tensioner
Support confort pivotant

Y0202

Ø 2,0 - 3,0 mm



Komfortspanner,
frei drehbar |¹
Swivelling comfort
tensioner
Support confort
pivotant

YB920



Komfortspanner,
kurz, frei drehbar |¹
Short swivelling
comfort tensioner
Support confort
pivotant court

YB921



Hülse
drehbar |¹
Cylinder
anchor
Douille
pivotante

YB985

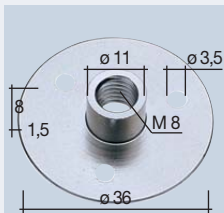

Bodenplatte |¹
Mounting plate
Support tablette large

Y0750 | Y0751



Bodenhalter |¹
Shelf holder
Support tablette

Y0710 | Y0720

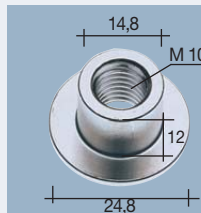

Bodenhalter |¹
Shelf holder
Support tablette

YB970

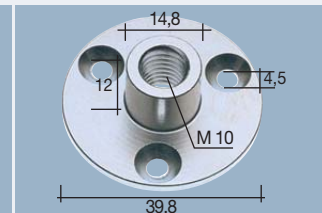

Bodenplatte |¹
Mounting plate
Support tablette large

YB950

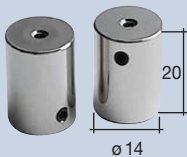

Zylinderklemme |¹
Cylinder shelf
support
Anneau de serrage
cylindrique

Y0755



Dekokugel |¹
Deco ball
Bille décorative

Y0680



Der Seilspanner oder Seilhalter wird auf den Komfortspanner gedreht. Der Komfortspanner kann dann auf einen Gewindestift oder eine Stockschraube bis auf 4-5 mm aufgedreht, das Seil von Hand vorgespannt und der Komfortspanner komplett aufgeschraubt werden. Der Komfortspanner ermöglicht durch seinen Schlüsselansatz eine straffe Spannung des Seiles.

Visser à fond le tendeur réglable ou le support câble sur le tendeur confort. Ensuite, visser le tendeur confort sur une vis sans tête ou vis à deux filetages. Grâce à son méplat, une tension très importante peut être faite avec le support confort.

The cable tensioner is fully screwed into the comfort tensioner and then the comfort tensioner tightened to the anchor fitting.



Ø 1,0 - 1,8 mm

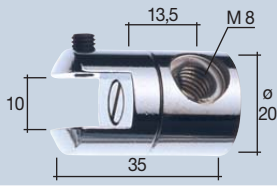

Halter, einseitig drehbar |¹
Shelf holder, single side swivel end
Support pivotant 1 face

Y0721

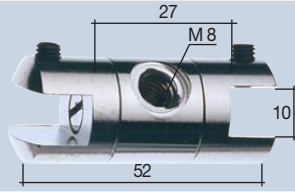

Halter, zweiseitig drehbar |¹
Shelf holder, double side swivel ends
Support pivotant 2 faces

Y0722

Ø 2,0 - 3,0 mm

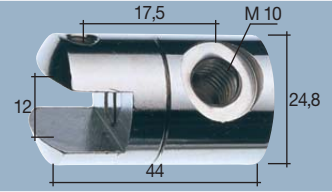

Halter, einseitig drehbar |¹
Shelf holder, single side swivel end
Support pivotant 1 face

YB930

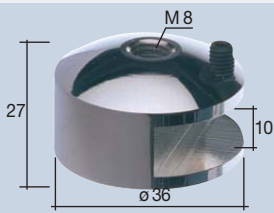

Dekohalter, einseitig |⁶
Deco holder, single side
Support déco 1 face

Y0711

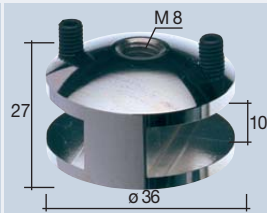

Dekohalter, zweiseitig |⁶
Deco holder, double side
Support déco 2 faces

Y0712



Glashalter |¹
Vertical panel holder
Support de tablette en verre

Y0730

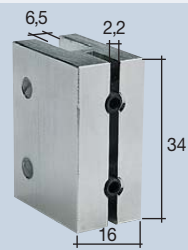

Displayhalter |¹
Display holder
Support de tablette vertical

Y0697

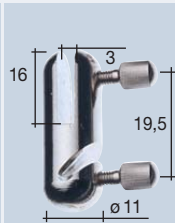

Stoffhalter |¹
Fabric holder
Support tissu

Y0690

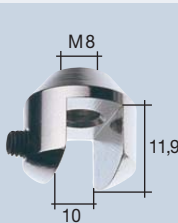

Halter, vertikal |¹
Vertical holder
Support vertical

Y0716

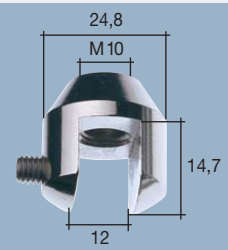

Halter, vertikal |¹
Vertical holder
Support vertical

YB940



Ø 1,0 - 1,8 mm

Haken ⁵ Hook Crochet	Öse ⁵ Eye Œillet	Ringhalter ¹ Ring holder Porte-anneau	Umlenkrolle ¹ Pulley Poulie de renvoi
Y0600	Y0610	Y0650	Y0670

Schiene, Alu weiß pulverbeschichtet ² Rail, white, powder coated Rail poudre époxy blanc	Schienenadapter ¹ Rail adapter Platine pour rail
Y0500	Y0510

Drahtschere bis 5 mm-Seil Cable cutter Cisaille coupe câble dia max. 5 mm	Handpresszange Crimping tool Pince manuelle à sertir
Y0050	Y0080

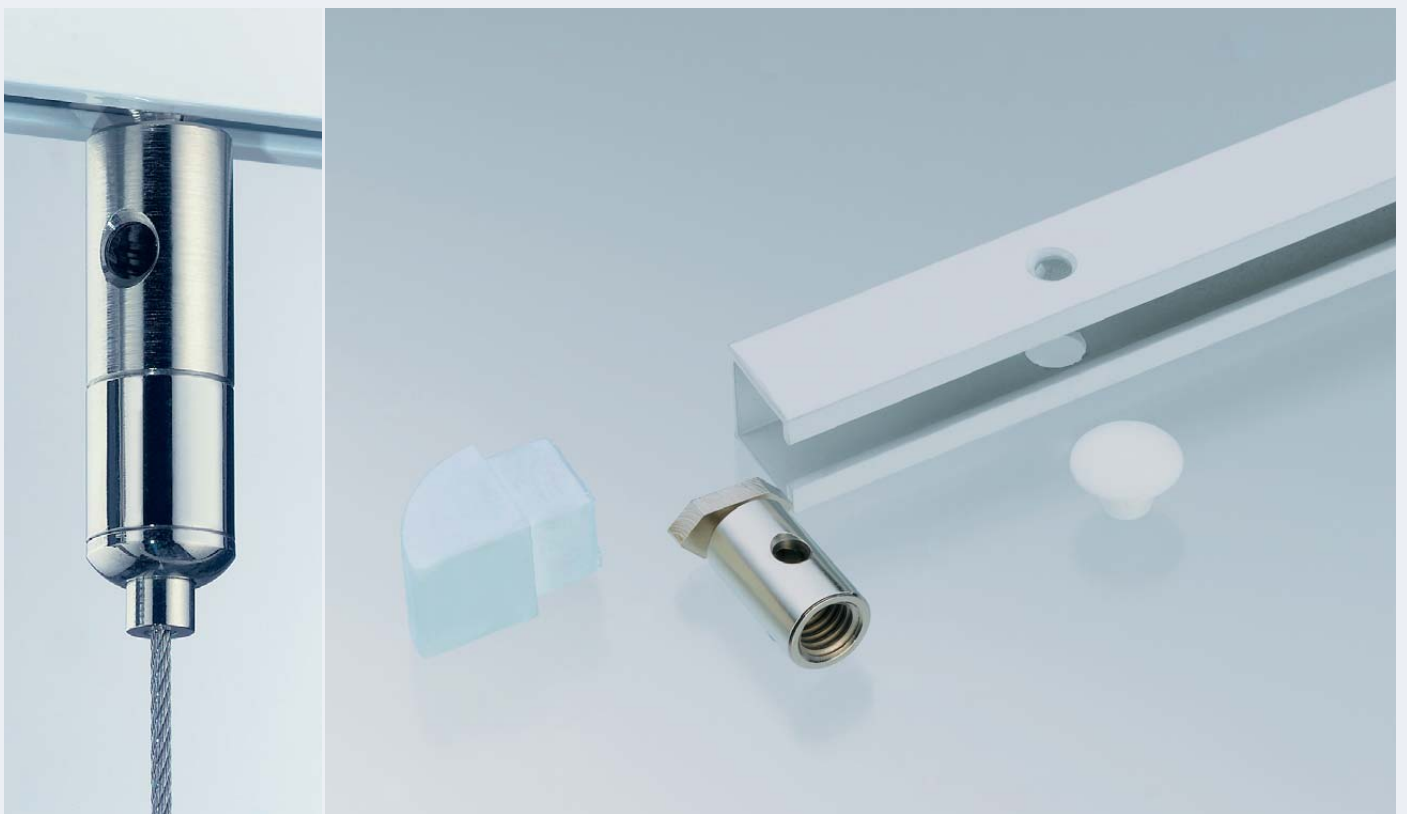

Ø 1,0 - 1,8 mm

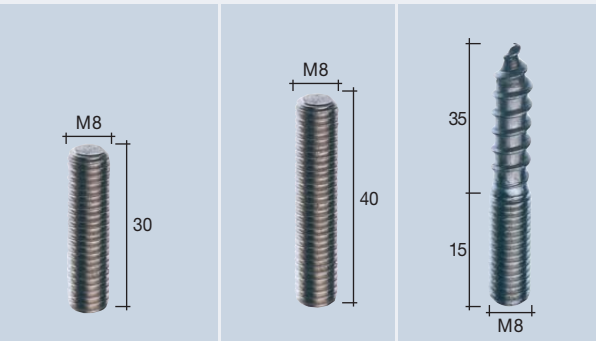

Gewindestift, kurz ³ Threaded stud, small Vis sans tête, court	Gewindestift ³ Threaded stud Vis sans tête	Stockschraube ³ Wood anchor Vis fileté métrique/bois
Y0020K	Y0020	Y0010

Ø 2,0 - 3,0 mm

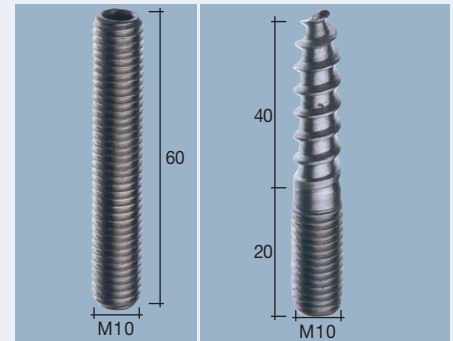

Gewindestift ³ Threaded stud Vis sans tête	Stockschraube ³ Wood anchor Vis fileté métrique/bois
YB0021	YB0011

Maximale Gebrauchslast in kg | Maximum load capacities in kg | Charges maximales en kg

Seildurchmesser Rope diameter Diamètre du câble en mm	Seilkonstruktion Rope construction Construction du câble	Seilspanner Cable tensioner Tendeur réglable	Seilhalter Cable holder Support câble	Artikel-Nummer Part No. Référence
1,0	7 x 7	10	6	YO110
1,5	7 x 7	25	10	YO115
1,8	7 x 7	35	10	YO118
2,0	7 x 19	40	-	YB120
2,5	7 x 19	45	-	YB125
3,0	7 x 19	50	-	YB130

Weitere Angaben zur max. Gebrauchslast der Einzelkomponenten erhalten Sie auf Anfrage.
Further informations about the max. load capacity for connection elements on request.
Toutes indications complémentaires concernant les charges maximales de chaque article sur demande.

Verwendete Materialien:

- 1 Messing, vernickelt
- 2 Alu (weiß pulverbeschichtet, RAL 9003)
- 3 Edelstahl
- 4 Kupfer, verzinkt
- 5 Zink, vernickelt
- 6 Alu, vernickelt
- 7 Bandstahl St 1203, vernickelt
- 8 Messing
- 9 Hartferrit, ummantelt

Materials:

- 1 Nickel-plated brass
- 2 Aluminium (white, powder coated RAL 9003)
- 3 Stainless steel
- 4 Copper, galvanised
- 5 Nickel-plated zinc
- 6 Nickel-plated aluminium
- 7 Nickel-plated steel
- 8 Brass
- 9 Hard ferrite, coated

Matériaux utilisés:

- 1 Laiton nickelé
- 2 Aluminium (poudre époxy blanc RAL 9003)
- 3 Inox
- 4 Cuivre zingué
- 5 Zinc nickelé
- 6 Aluminium nickelé
- 7 Acier St 1203, nickelé
- 8 Laiton
- 9 le Ferrite

Technische Änderungen vorbehalten.
Indicated dimensions are subject to technical changes.
Sous réserve de modifications techniques.

Carl Stahl bietet noch weitere hochinteressante Produktprogramme für Architekten und Planer. Die Architektur-Produktpalette möchten wir Ihnen hier gerne vorstellen. Umfangreiches Prospektmaterial zu allen Systemen schicken wir Ihnen auf Anfrage gerne zu.

Carl Stahl offers a broad range of products and services to architects, engineers and designers. We would be happy to provide information on any of our family of products upon request.

Carl Stahl c'est également un vaste système d'éléments architecturaux. Différentes lignes de produits du plus grand intérêt pour les architectes, les métalliers,... Toute la palette de catalogues est disponible et vous sera expédiée sur simple demande.

X-TEND

Das Netzwerk für Innovationen. Ein Stahlseilnetz für kreative Lösungen im Innen- und Außenbereich. Hochwertige Edelstahlseile sorgen für Langlebigkeit und Stabilität.

The excitingly translucent stainless steel mesh. A material providing creative solutions in both structural and design applications. The use of high quality stainless steel cables ensures longevity and stability.

Filet innovent souple en câble inox. Un filet pour des solutions créatives en intérieur comme en extérieur. Le câble inox de haute qualité c'est la garantie de la longévité.



I-SYS

Das innovative Edelstahlseilsystem für architektonische und konstruktive Anwendungen.

The innovative stainless steel cable system for architecture and design.

Systèmes en câble inox innovants pour des applications en architecture et en design.

Utilisation pour garde-corps, contreventements, végétalisations de façades...





Germany

Carl Stahl GmbH
Tobelstr. 2
73079 Sößen
Tel.: (0049) (0) 7162-4007-2100
Fax: (0049) (0) 7162-4007-8821
E-Mail: architektur@carlstahl.com

Austria

Carl Stahl GmbH
Gewerbepark 660
A-6870 Bezau
Tel.: (0043) (55 14) 3 01 05-0
Fax: (0043) (55 14) 3 01 05-90
E-Mail: bezau@carlstahl.com

Belgium

Carl Stahl Benelux B.V.
Kleine Tocht 5
NL-1507 CB Zaandam
Tel.: (0031) 75-6318536
Fax: (0031) 75-6310968
E-Mail: carlstahlbenelux@planet.nl

Brazil

Carl Stahl Aços,
Cabos e Sistemas Ltda.
Rua Silva Bueno, 165 – Ipiranga
04208-050 São Paulo - SP
Tel.: 0055 (11) 6914-7100
Fax: 0055 (11) 6914-1129
E-Mail: vendas@carlstahl.com.br

Czech Republic

Carl Stahl & spol, s. r. o.
Bozanovská 2098
CZ-19300 Praha 9
Tel.: (00420) 281 925 977
Fax: (00420) 281 920 172
E-Mail: info@carlstahl.cz

Denmark

Carl Stahl Danrope A/S
Karetmagervej 19
DK-7000 Fredericia
Tel.: (0045) 76240234
Fax: (0045) 76240345
E-Mail: salg@carlstahl.dk

Dubai/U.A.E.

Carl Stahl Middle East LLC
Carl Stahl Lifting Equipment
Industries LLC
Carl Stahl Safety & Security Consultancy
P. O. BOX 26607
Al Jadaf (Plot 149)
Dubai - U. A. E.
Tel.: (00 971) 50-55 17544
(00 971) 4-324 1946
Fax: (00 971) 4-324 3116
E-Mail: stahl@emirates.net.ae

Finland

Carl Stahl Oy
PL/Box 711
Jonkankatu 2
FIN-20361 Turku
Tel.: (00 358) 2 275 00 60
Fax: (00 358) 2 275 00 69
E-Mail: myynti@carlstahl.com

France

Carl Stahl
43, rue des Tuileries
F-67460 Souffelweyersheim
Tel.: (0033) (3) 88 18 37 00
Fax: (0033) (3) 88 20 51 96
E-Mail: info@carlstahl.fr

Great Britain

Carl Stahl Evita Ltd.
Carl Stahl House
Farfield Park, Manvers Estate
Rotherham S63 5DB
Tel.: (0044) (1) 709-76 30 58
Fax: (0044) (1) 709-76 30 67
E-Mail: sales@carlstahlevita.co.uk

Hungary

Carl Stahl Hungaria Kft
Jedlik Anyos u. 26
H-2330 Dunaharaszti
Tel.: (0036)-24 491 452
Fax: (0036)-24 460 123
E-Mail: janosgill@carlstahl.hu

Netherlands

Carl Stahl Benelux B.V.
Kleine Tocht 5
NL-1507 CB Zaandam
Tel.: (0031) 75-6318536
Fax: (0031) 75-6310968
E-Mail: carlstahlbenelux@planet.nl

Norway

Carl Stahl AS
Postboks 56
N-3139 Skallestad
Tel.: (0047) 33 30 47 15
Fax: (0047) 33 30 47 16
E-Mail: jan-erik.jansson@carlstahl.no

Poland

Carl Stahl Tech Service Sp. z.o.o.
ul. Spokojna 3
74-404 Cychry
Tel.: (0048) (0)95-728 33 16
Fax: (0048) (0)95-728 88 86
E-Mail: biuro@carlstahl.pl

Republic of Ireland

Carl Stahl Evita Ltd.
Carl Stahl House
Farfield Park, Manvers Estate
S63 5DB Rotherham GB
Tel.: (0044) (1) 709-76 30 58
Fax: (0044) (1) 709-76 30 67
E-Mail: sales@carlstahlevita.co.uk

Switzerland

Carl Stahl AG
Stachelhofstrasse 12
CH-8854 Siebnen
Tel.: (0041)-(055) 450 50 00
Fax: (0041)-(055) 450 50 05
E-Mail: info@carlstahl.ch

USA + Canada

Carl Stahl DécorCable, LLC
660 West Randolph Street
Chicago, IL 60661, USA
Tel.: (001) 312 474 1100
Fax: (001) 312 474 1789
E-Mail: sales@decorcable.com

Ihr **POSILOCK**-Vertragspartner:
Your **POSILOCK**-partner:
Votre partenaire **POSILOCK**: