

Tank Blanketing Regulators

Low-Pressure Reducing Regulator
Type BR

Low-Pressure Relief Valve
Type BS

MADE 
SWISS



Description

Low-pressure reducing and relief valves regulate pressures in mbar range and serve the inertisation and blanketing of containers, reactors, stirrer vessels, centrifuges, etc. with inert gas such as nitrogen.

Inertisation

For discontinuous batch processes before process start, the reactor chamber is rendered inert. The inertisation of spaces describes the process to displace the oxygen in the air or other reactive or explosive gases or gas compounds by adding of inert gas.



Ventilation/Blanketing

Aim of ventilation/protective gas blanketing is maintaining the inert condition inside the reactor, tank or container during the manufacturing process.

Highlights

- Regulating pressures up to 1000 mbar
- Nominal diameters DN15 - DN100
- DN15 - DN50 PN16
- DN80 - DN100 PN10
- 1/2"-4" ANSI/ASME 150 lbs
- Counterpressure-resistant up to 2 bar
- Vacuum-resistant
- Stainless steel regulators
- Nickel alloy regulators
- Clean regulators
- Low-maintenance (friendly)
- ATEX optional

Technical Data

Nominal Pressure Rating

Stainless steel casing	: DN15 to DN50	16 bar
	DN80 to DN100	10 bar
Max. inlet pressure	: up to DN50 ≤ 50°C	16 bar
	at max. 150°C	13 bar
	DN80 – DN100 ≤ 50°C	10 bar
	at max. 150°C	8 bar
Max. negative pressure	: vacuum-resistant	
Control range springs	: -200 to 1000 mbar	
Control range pilot pressure	: -200 to 2000 mbar	
Max. temp. FFKM (Kalrez®)	: -20°C to +150°C	
Max. temp. PKM (Viton®)	: -20°C to +120°C	
Max. temp. PVDF	: -20°C to +130°C	

Seat Tightness/Standard Setting

Seat tightness according to P12; EN 12266-1:2003;	
	leakage rate A
Flow rate at standard setting:	DN 15 / 1/2" : 0.5 Nm3/h
	DN 25 / 1" : 1 Nm3/h
	DN 40 / 1 1/2" : 2 Nm3/h
	DN 50 / 2" : 2 Nm3/h
	DN 80 / 3" : 5 Nm3/h
	DN 100 / 4" : 5 Nm3/h

Designs/Certificates

Design according to pressure equipment directive	: DGR 97/23/EG
Marking ≥ DN32	: CE0036
Declaration of Conformity QS 04 ATEX 2006	: ⚠ II 2GD opt. IIC
FDA conformity for elastomers:	: US.FDA 21 CFR
Factory Acceptance Certificate:	: EN10204 2.2
	EN10204 3.1

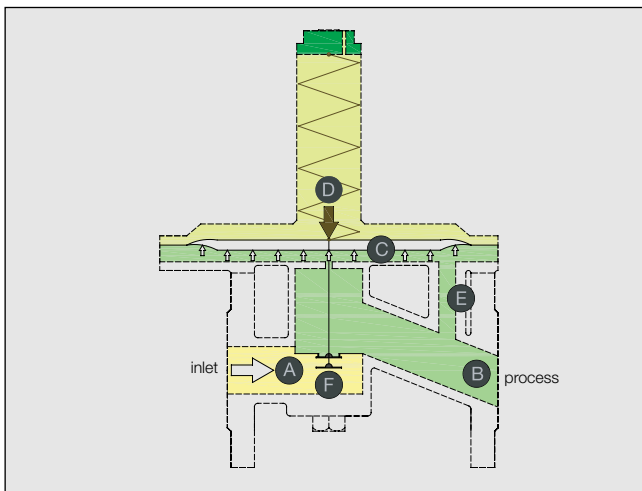

Reducing Regulator Function

Spring-loaded pressure reducing regulators are “relative pressure regulators”, designed to keep the process pressure “B” at a constant level. The nominal pressure is set by means of the setscrew, located at the spring housing. When at rest, the regulator remains in an open position. When the pressure “A” rises, pressure is released through the open valve seat “F” to the process side of the valve and through the internal feedback bore “E” underneath the diaphragm. This will continue, until the diaphragm force “C” exceeds the spring force “D”, while the process pressure “B” rises. The diaphragm is lifted and the valve seat “F” closes. In the event that the process pressure “B” drops below the pre-adjusted nominal pressure, the spring force “D” presses the diaphragm downwards, so that the valve seat “F” opens and admits gas until pressure equalization is reached again.

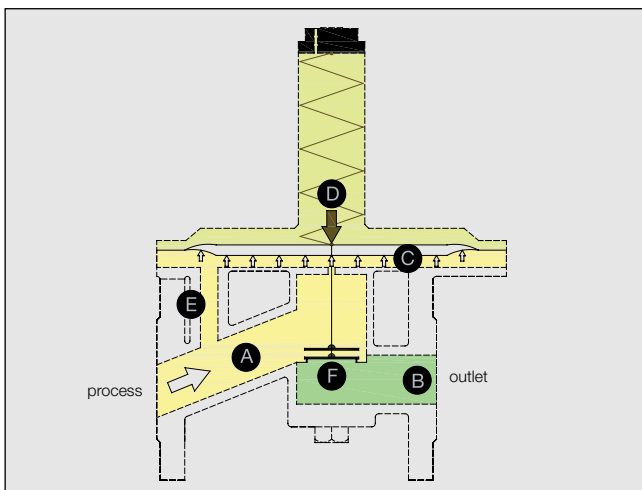

Relief Valve Function

Spring-loaded relief valves are “relative pressure regulators”, designed to keep the process pressure “A” at a constant level. The nominal pressure is set by means of the setscrew, located at the spring housing. When at rest, the regulator remains in a closed position. When the process pressure “A” increases, pressure is released through the internal feedback bore “E” underneath the diaphragm. If the diaphragm force “C” exceeds the spring force “D” the valve seat “F” opens and the over pressure is discharged to the vent side “B”. If the process pressure “A” drops, the diaphragm force “C” is lower compared to the spring force “D” and the valve seat “F” closes. The pressure in the vent line can be atmospheric or vacuum. With vacuum in the vent line the flow capacity of the regulator is increased.

Primary Pressure Reference (Ratio)

Modification of inlet pressure p_1 impacts on outlet pressure p_2 . If p_1 is increased, p_2 drops. The ratio indicates, how much the outlet pressure deviates with reference to the inlet pressure per 1 bar. If e.g. the inlet pressure is increased by 2 bar, then the outlet pressure drops for a piston with ratio 3 mbar by 6 mbar.

If the inlet pressure is lower, then the outlet pressure increases accordingly. The ratio also impacts on the control range of the adjusting spring. The indicated adjusting spring control ranges are for inlet pressure 2 bar g.

Seat Versions

Seat versions D and R are non-discharged not pressure compensated unbalanced seats (or direct-acting seats) responding stronger to a change in inlet pressure (higher ratio). Non-discharged seats are suitable for applications with constant inlet pressure.

Seat version E is a pressure compensated seat, responding only slightly to inlet pressure changes (lower ratio). Discharged seats have an increased hysteresis, the setting value reproduction is not as good than for a direct-acting seat. They are only to be used with fluctuating inlet pressure.

Regulator Test (Test Setup)



All pressure regulators are tested on our test bench for function and are set to process data. Before this function test the pressure regulators are tested for leakage to the outside. For every manufactured regulator performance data and regulator characteristics are captured.

Pressure Reducing Valve

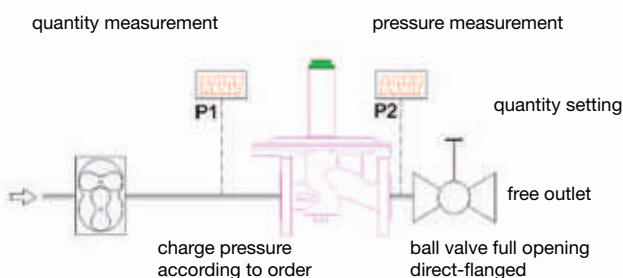

Discharge Valve

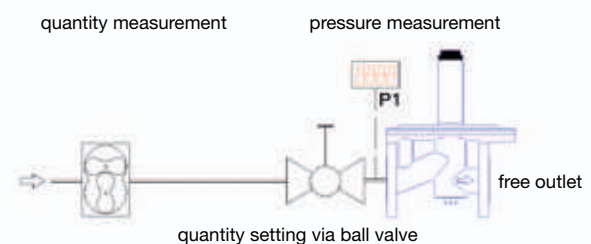

Pressure Regulator Characteristics

Typical Pressure Profile

The characteristic pressure profile is the best way to analyze the pressure regulator system performance. For these pressure profile diagrams the set pressure is indicated with reference to the flow rate (see below). The two profiles describe an

idealized pressure profile for a pressure reducing valve and a discharge valve.

The regulators are not set static, but dynamic with low flow rate (e.g. DN25 at 1 Nm³/h).

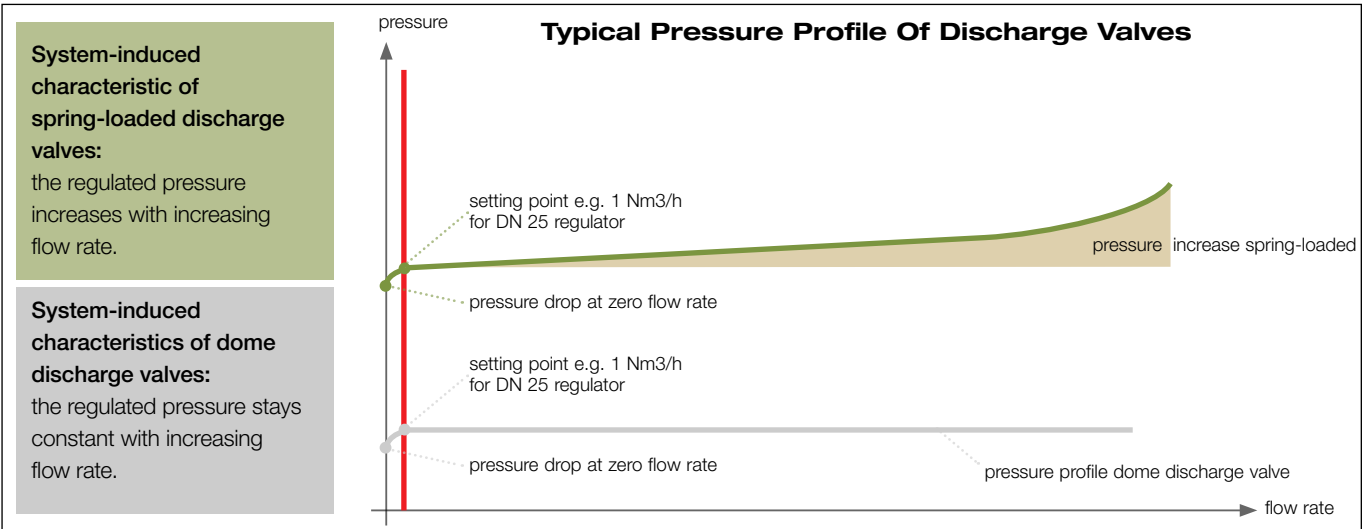
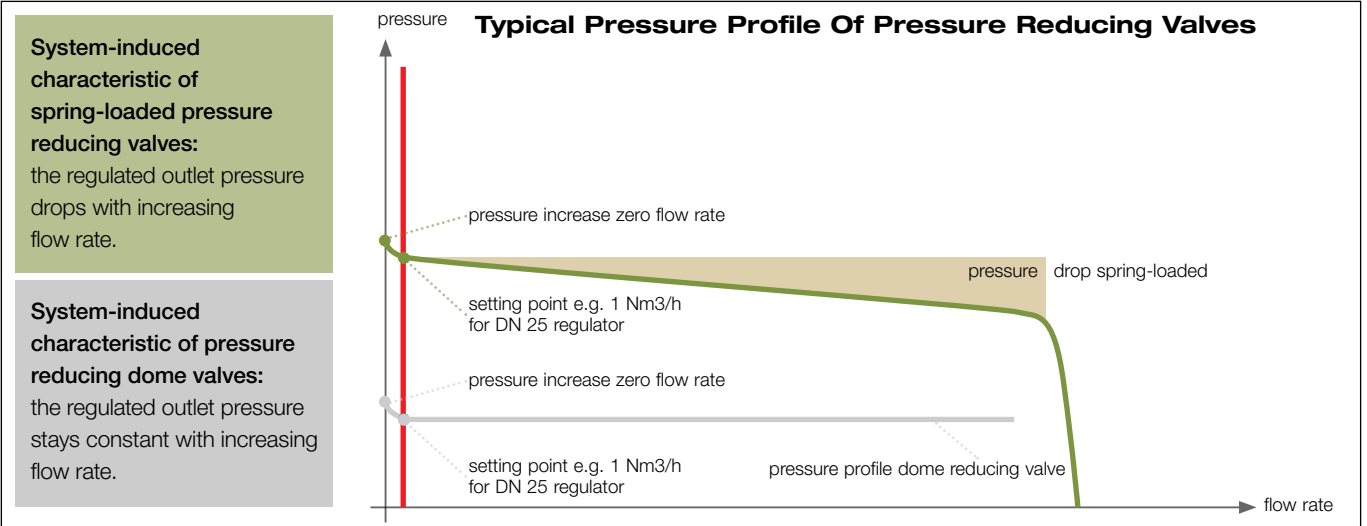

External Impulse Line (Pressure Feedback)

If the secondary pressure is set below 10 mbar, or are pressure losses at the pressure reducing valve outlet, e.g. due to built-in instruments, to be expected, which will exceed the set pressure at the pressure reducing valve, then external impulse line is to be considered. Also, if quickly large flow rates are demanded.

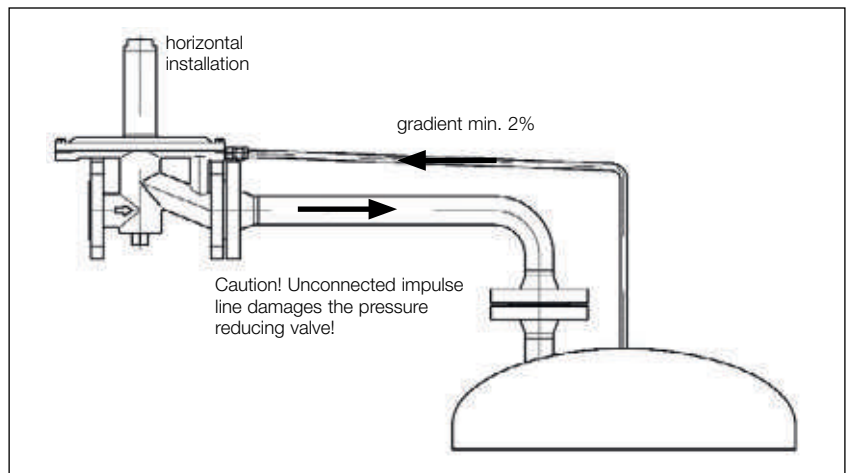

Standard Regulators

Application	For processes, e.g. in chemical-pharmaceutical industry, without increased performance profile.
Design	Inline and angle pattern/corner design.
Surfaces	Without specific treatment.
Self-draining	Conditional.
Example of use	Control processes for fluids and gases, no specific requirements for cleanliness and cleanability of the pressure regulator.

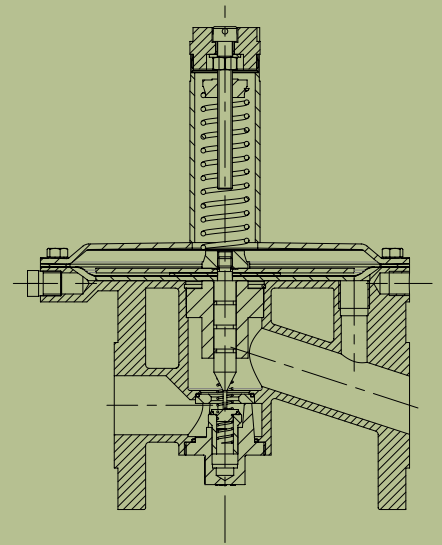

Vario Regulators

Application	For processes, e.g. in chemical-pharmaceutical industry, with increased requirements for corrosion resistance.
Design	Inline pattern.
Surfaces	Without specific treatment, others on request.
Self-draining	Conditional.
Example of use	Control processes for aggressive fluids and gases, no specific requirements for cleanability of pressure regulator and dead spots.

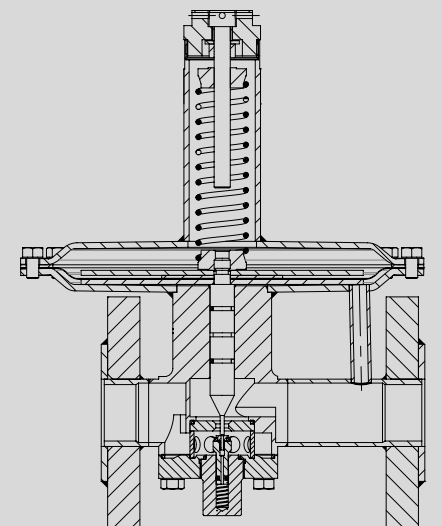

Clean Regulators

Application	For processes, e.g. in the pharmaceutical industry and food processing, with increased requirements for surfaces, dead spots and cleanability.
Design	Angle pattern.
Specials	Corners replaced with radii, minimized dead space.
Surfaces	Medium contact surfaces <math>< Ra 0.8 \mu m.</math>
Self-draining	Yes.
Example of use	A typical application for these pressure valves is the regulation of sterile air (bio reactor).

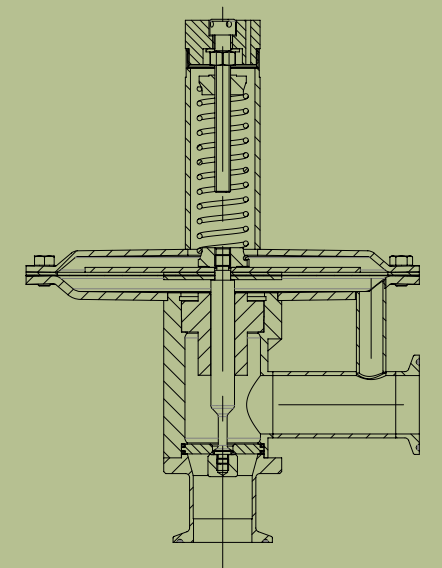

Example of Use

Tank Blanketing Systems

Where does blanketing take place? In all areas where in batch processes products or liquids are being handled, stored and covered with an inert atmosphere (mainly N₂). How is blanketing accomplished? For optimum performance there are two pressure regulators required. A pressure reducing valve for entering the gas (inhale) and a relief valve for the discharging gas (exhale). Blanketing normally takes place in the pressure range from 10 to 50 mbar. We recommend to operate the regulators adjusted and sealed, e. g. reducing valve at 15 mbar, relief valve at 40 mbar. The two function points should be as far apart as possible to obtain a wide pressure spread without the consumption of gas. As a minimum pressure spread we recommend 8 mbar. In order to avoid the entry of oxygen into the vessel (for solvents), overpressure is necessary. In the event that no gas discharge is wanted (handling of toxic products) negative pressure must be kept.

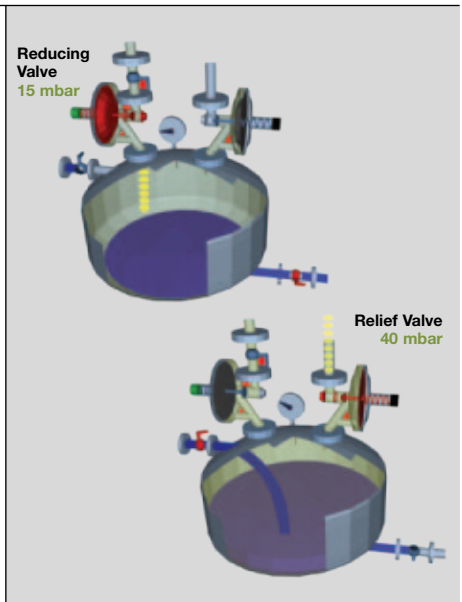

Inerting With Overpressure/Pneumatic Transfer

Inerting means the exchange of the standard atmosphere with a non-active (inert) gas atmosphere. Behind the diaphragm of spring loaded pressure regulators atmospheric pressure exists. If the space behind the diaphragm is sealed off and charged with a pilot pressure, the regulator will no longer use atmosphere as reference point but the pilot pressure (Pilot pressure design). The exchange of the gases is accelerated. If the reactor is inert, the pilot pressure is disabled and the low pressure regulators operate automatically in the blanketing mode (see blanketing systems). Beside blanketing, this design permits different other functions such as: Inerting with overpressure, pneumatic transfer of products, blow through, blocking.

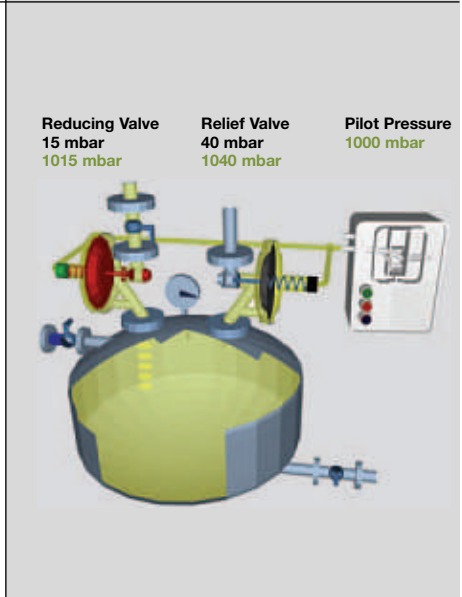

Inerting With Vacuum

If the reactor withstands vacuum, inerting can be accomplished with negative pressure. With a vacuum pump, 80% of the standard atmosphere is sucked off, the remaining pressure is 200 mbar abs. As a result, just 20% oxygen molecules remain in the vessel. Afterwards, the reduced volume is replaced with Nitrogen back to the pressure of 1000 mbar abs through the reducer. This dilution of the remaining oxygen (approx. 1:5 per inerting cycle) is being continued until the rest oxygen content is below the predetermined value. If the reactor is inert, production can start. The low pressure regulators operate automatically in the blanketing mode (see blanketing systems).

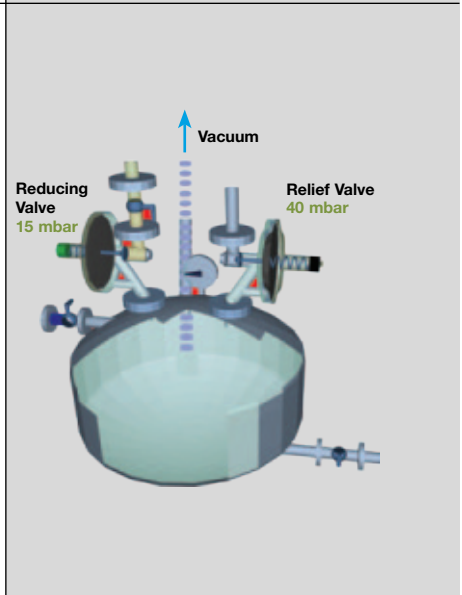

Why Inertisation/Ventilation?

1. Explosion Protection

Excerpt ATEX 137:
Measures to prevent explosive atmospheres outplay all other explosion prevention measures. By replacing the air mixture

with inert gas (inert substances are sluggish in reaction and do not react within the respective reaction system) the formation of an explosive atmosphere is prevented.

2. ATEX Zone Reduction

Zone definition according to ATEX 137

ZONE 0

Area, in which explosive atmosphere as a compound of air and combustible gases, vapors or fog is continuously, over a long period of time or often is present.

ZONE 1

Area, in which during normal operation occasionally an explosive atmosphere as a compound of air and combustible gases, vapors or fog can form.

ZONE 2

Area, in which during normal operation an explosive atmosphere as a compound of air and combustible gases, vapors or fog does not or only short-term is present.

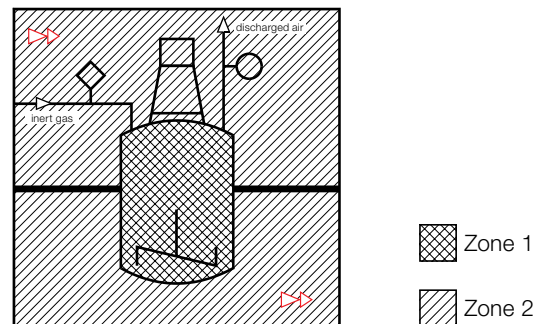

Example for Switzerland:
According to SUVA (Swiss employers liability insurance) zone changeover in apparatus engineering using controlled inertisation from ZONE 0 to ZONE 1 is possible.
(Literature: Explosionsschutz Grundsätze Mindestvorschriften Zonen, order number 215Gd, suvaPro, CH-6002 Luzern)

3. Oxidation Protection

Oxygen contained in the air can react or oxidize with other substances. By replacing the air mixture in the container with inert gas the forming of an oxidation-enabled atmosphere

is prevented. As a basic prerequisite for validation constant, reproducible conditions are created.

4. Contamination Protection

Ventilation in positive pressure processes protects the product from outside contamination. Ventilation in negative pressure

processes prevents contamination of the surroundings through process substances.

Inert Gas Cost Optimisation

The working points set on the regulators shall be as far apart as possible to obtain a broad pressure range without gas consumption. Minimised nitrogen consumption minimises costs significantly.

- Nitrogen purchase cost minimisation
- Minimisation of product losses into the exhaust gas system
- Waste gas treatment minimisation

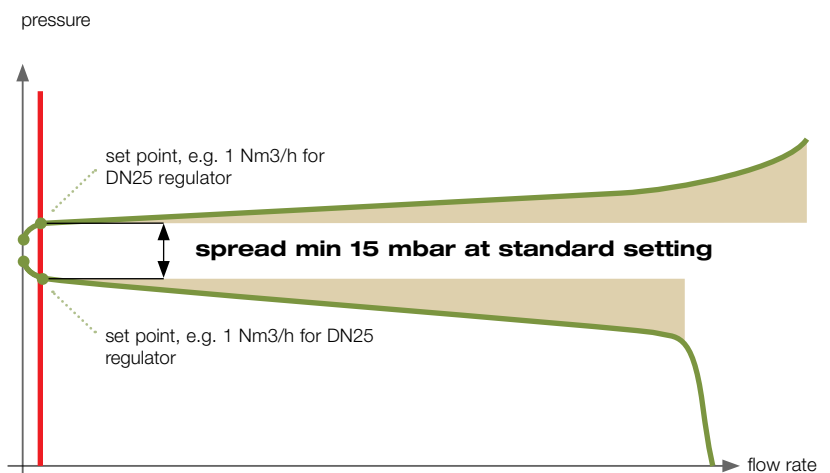



Zuercher Technik Ltd. develops, designs and manufactures high-quality reliable pressure valves. Low pressure regulators for inertisation, blanketing and ventilation of chemical and pharmaceutical plants take center stage.

Further applications can be provided with our medium pressure regulators in a variety of versions for other industries, such as the food industry and mechanical engineering. Individual and project-related designs in cooperation with our clients are our strength. Our team is ready to meet your demands.



Type Overview Low Pressure Reducing Valves (BR) And Discharge Valves (BS)

DIN-Inline		ASME-Inline		DIN angle pattern		ASME angle pattern	
Size	Type	Nominal diameter	Type	Nominal diameter	Type	Nominal diameter	Type
DN 15	BR/BS15i	1"	BR 1i	DN 15	BR/BS15e	1/2"	BR/BS0.5e
DN 25	BR/BS25i	2"	BR 2i	DN 25	BR/BS25e	1"	BR/BS1e
DN 40	BR/BS40i			DN 40	BR/BS40e	2"	BR/BS2e
DN 50	BR/BS50i			DN 50	BR/BS50e	3"	BR/BS3e
				DN 80	BR/BS80e	4"	BR/BS4e
				DN 100	BR/BS100e		